

Pressure Measurement

Transmitters for basic requirements

SITRANS P200
for gauge and absolute pressure

1

Overview



The SITRANS P200 pressure transmitter measures the gauge and absolute pressure of liquids, gases and vapors.

- Ceramic measuring cell
- Gauge and absolute measuring ranges 1 to 60 bar (15 to 1000 psi)
- For general applications

Benefits

- High measuring accuracy
- Rugged stainless steel enclosure
- High overload withstand capability
- For aggressive and non-aggressive media
- For measuring the pressure of liquids, gases and vapors
- Compact design

Application

The SITRANS P200 pressure transmitter for gauge and absolute pressure is used in the following industrial areas:

- Mechanical engineering
- Shipbuilding
- Power engineering
- Chemical industry
- Water supply

Design

Device structure without explosion protection

The pressure transmitter consists of a piezoresistive measuring cell with a diaphragm installed in a stainless steel enclosure. It can be used with a connector per EN 175301-803-A (IP65), a round plug M12 (IP67), a cable (IP67) or a Quickon cable quick screw connection (IP67) connected electrically. The output signal is between 4 and 20 mA or 0 and 10 V.

Device structure with explosion protection

The pressure transmitter consists of a piezoresistive measuring cell with a diaphragm installed in a stainless steel enclosure. It can be used with a connector per EN 175301-803-A (IP65) or a round plug M12 (IP67) connected electrically. The output signal is between 4 and 20 mA.

Function

The pressure transmitter measures the gauge and absolute pressure of liquids and gases as well as the level of liquids.

Mode of operation

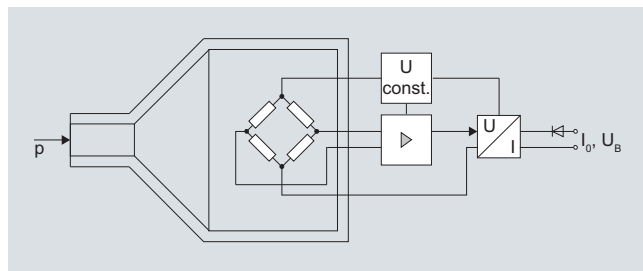

SITRANS P200 pressure transmitters (7MF1565-...), functional diagram

The ceramic measuring cell has a thin-film resistance bridge to which the operating pressure p is transmitted through a ceramic diaphragm.

The voltage output from the measuring cell is converted by an amplifier into an output current of 4 to 20 mA or an output voltage of 0 to 10 V DC.

The output current and voltage are linearly proportional to the input pressure.

Pressure Measurement

Transmitters for basic requirements

SITRANS P200 for gauge and absolute pressure

1

Technical specifications

Application	
Gauge and absolute pressure measurement	Liquids, gases and vapors
Mode of operation	
Measuring principle	Piezo-resistive measuring cell (ceramic diaphragm)
Measured variable	Gauge and absolute pressure
Inputs	
Measuring range	
<ul style="list-style-type: none"> Gauge pressure <ul style="list-style-type: none"> - Metric - US measuring range Absolute pressure <ul style="list-style-type: none"> - Metric - US measuring range 	1 ... 60 bar (15 ... 870 psi) 15 ... 1000 psi
<ul style="list-style-type: none"> Absolute pressure <ul style="list-style-type: none"> - Metric - US measuring range 	0.6 ... 16 bar a (10 ... 232 psia) 10 ... 300 psia
Output	
Current signal	4 ... 20 mA
<ul style="list-style-type: none"> Load Auxiliary power U_B 	$(U_B - 10 \text{ V}) / 0.02 \text{ A}$ DC 7 ... 33 V (10 ... 30 V for Ex)
Voltage signal	0 ... 10 V DC
<ul style="list-style-type: none"> Load Auxiliary power U_B Power consumption 	$\geq 10 \text{ k}\Omega$ 12 ... 33 V DC $< 7 \text{ mA}$ at 10 k Ω
Characteristic curve	Linear rising
Measuring accuracy	
Error in measurement at limit setting incl. hysteresis and reproducibility	<ul style="list-style-type: none"> Typical: 0.25 % of full-scale value Maximum: 0.5 % of full-scale value
Step response time T_{99}	$< 5 \text{ ms}$
Long-term stability	
<ul style="list-style-type: none"> Lower range value and measuring span 	0.25 % of full-scale value/year
Influence of ambient temperature	
<ul style="list-style-type: none"> Lower range value and measuring span Influence of power supply 	0.25 %/10 K of full-scale value 0.005 %/V
Conditions of use	
Process temperature with gasket made of:	
<ul style="list-style-type: none"> FPM (Standard) Neoprene Perbunan EPDM 	-15 ... +125 °C (+5 ... +257 °F) -35 ... +100 °C (-31 ... +212 °F) -20 ... +100 °C (-4 ... +212 °F) -40 ... +145 °C (-40 ... +293 °F), usable for drinking water
Ambient temperature	-25 ... +85 °C (-13 ... +185 °F)
Storage temperature	-50 ... +100 °C (-58 ... +212 °F)
Degree of protection (to EN 60529)	<ul style="list-style-type: none"> IP 65 with connector per EN 175301-803-A IP 67 with M12 connector IP 67 with cable IP 67 with cable quick screw connection
Electromagnetic compatibility	<ul style="list-style-type: none"> acc. EN 61326-1/-2/-3 acc. NAMUR NE21, only for ATEX versions and with a max. measuring deviation $\leq 1 \%$

Design	
Weight	Approx. 0.090 kg (0.198 lb)
Process connections	See dimension drawings
Electrical connections	<ul style="list-style-type: none"> Connector per EN 175301-803-A Form A with cable inlet M16x1.5 or 1/2-14 NPT or Pg 11 M12 connector 2 or 3-wire (0.5 mm²) cable ($\varnothing \pm 5.4 \text{ mm}$) Quickon cable quick screw connection
Wetted parts materials	
<ul style="list-style-type: none"> Measuring cell Process connection Gasket 	Al ₂ O ₃ - 96 % Stainless steel, mat. No. 1.4404 (SST 316 L) FPM (Standard) Neoprene Perbunan EPDM
Non-wetted parts materials	
<ul style="list-style-type: none"> Enclosure Rack Cables 	Stainless steel, mat. No. 1.4404 (SST 316 L) Plastic PVC
Certificates and approvals	
Classification according to pressure equipment directive (PED 97/23/EC)	For gases of fluid group 1 and liquids of fluid group 1; complies with requirements of article 3, paragraph 3 (sound engineering practice)
Lloyd's Register of Shipping (LR)	12/20010
Germanischer Lloyd (GL)	GL19740 11 HH00
American Bureau of Shipping (ABS)	ABS_11_HG 789392_PDA
Bureau Veritas (BV)	BV 271007A0 BV
Det Norske Veritas (DNV)	A 12553
Drinking water approval (ACS)	ACS 11 ACC NY 055
GOST	GOST-R
Underwriters Laboratories (UL)	
<ul style="list-style-type: none"> for USA and Canada worldwide 	UL 20110217 - E34453 IEC UL DK 21845
Explosion protection	
Intrinsic safety "i" (only with current output)	Ex II 1/2 G Ex ia IIC T4 Ga/Gb Ex II 1/2 D Ex ia IIIC T125 °C Da/Db
EC type-examination certificate	SEV 10 ATEX 0146
Connection to certified intrinsically-safe resistive circuits with maximum values:	$U_i \leq 30 \text{ V DC}$; $I_i \leq 100 \text{ mA}$; $P_i \leq 0.75 \text{ W}$
Effective internal inductance and capacity for versions with plugs per EN 175301-803-A and M12	$L_i = 0 \text{ nH}$; $C_i = 0 \text{ nF}$

Pressure Measurement

Transmitters for basic requirements

SITRANS P200
for gauge and absolute pressure

1

Selection and ordering data					Order No.	Order code
SITRANS P 200 pressure transmitters for pressure and absolute pressure for general applications					7MF1565-	
Characteristic curve deviation typ. 0.25 %						
Wetted parts materials: Ceramic and stainless steel + sealing material						
Non-wetted parts materials: stainless steel						
Measuring range		Overload limit		Burst pressure		
		Min.	Max.			
For gauge pressure						
0 ... 1 bar	(0 ... 14.5 psi)	-0.4 bar (-5.8 psi)	2.5 bar (36.26 psi)	> 2.5 bar (> 36.3 psi) ▶		3 BA
0 ... 1.6 bar	(0 ... 23.2 psi)	-0.4 bar (-5.8 psi)	4 bar (58.02 psi)	> 4 bar (> 58.0 psi) ▶		3 BB
0 ... 2.5 bar	(0 ... 36.3 psi)	-0.8 bar (-11.6 psi)	6.25 bar (90.65 psi)	> 6.25 bar (> 90.7 psi) ▶		3 BD
0 ... 4 bar	(0 ... 58.0 psi)	-0.8 bar (-11.6 psi)	10 bar (145 psi)	> 10 bar (> 145 psi) ▶		3 BE
0 ... 6 bar	(0 ... 87.0 psi)	-1 bar (-14.5 psi)	15 bar (217 psi)	> 15 bar (> 217 psi) ▶		3 BG
0 ... 10 bar	(0 ... 145 psi)	-1 bar (-14.5 psi)	25 bar (362 psi)	> 25 bar (> 362 psi) ▶		3 CA
0 ... 16 bar	(0 ... 232 psi)	-1 bar (-14.5 psi)	40 bar (580 psi)	> 40 bar (> 580 psi) ▶		3 CB
0 ... 25 bar	(0 ... 363 psi)	-1 bar (-14.5 psi)	62.5 bar (906 psi)	> 62.5 bar (> 906 psi) ▶		3 CD
0 ... 40 bar	(0 ... 580 psi)	-1 bar (-14.5 psi)	100 bar (1450 psi)	> 100 bar (> 1450 psi) ▶		3 CE
0 ... 60 bar	(0 ... 870 psi)	-1 bar (-14.5 psi)	150 bar (2175 psi)	> 150 bar (> 2175 psi) ▶		3 CG
Other version, add order code and plain text: Measuring range: ... up to... bar (psi)						9 AA H 1 Y
For absolute pressure						
0 ... 0.6 bar a	(0 ... 8.7 psia)	0 bar a (0 psia)	3 bar a (43.51 psia)	> 2.5 bar a (> 36.3 psia)		5 AG
0 ... 1 bar a	(0 ... 14.5 psia)	0 bar a (0 psia)	2.5 bar a (36.26 psia)	> 2.5 bar a (> 36.3 psia) ▶		5 BA
0 ... 1.6 bar a	(0 ... 23.2 psia)	0 bar a (0 psia)	4 bar a (58.02 psia)	> 4 bar a (> 58.0 psia) ▶		5 BB
0 ... 2.5 bar a	(0 ... 36.3 psia)	0 bar a (0 psia)	6.25 bar a (90.65 psia)	> 6.25 bar a (> 90.7 psia) ▶		5 BD
0 ... 4 bar a	(0 ... 58.0 psia)	0 bar a (0 psia)	10 bar a (145 psia)	> 10 bar a (> 145 psia) ▶		5 BE
0 ... 6 bar a	(0 ... 87.0 psia)	0 bar a (0 psia)	15 bar a (217 psia)	> 15 bar a (> 217 psia) ▶		5 BG
0 ... 10 bar a	(0 ... 145 psia)	0 bar a (0 psia)	25 bar a (362 psia)	> 25 bar a (> 362 psia) ▶		5 CA
0 ... 16 bar a	(0 ... 232 psia)	0 bar a (0 psia)	40 bar a (580 psia)	> 40 bar a (> 580 psia) ▶		5 CB
Other version, add order code and plain text: Measuring range: ... up to ... mbar a (psia)						9 AA H 1 Y
Measuring ranges for gauge pressure (only for US market)						
(0 ... 15 psi)		(-5.8 psi)	(35 psi)	(> 35 psi)		4 BB
(3 ... 15 psi)		(-5.8 psi)	(35 psi)	(> 35 psi)		4 BC
(0 ... 20 psi)		(-5.8 psi)	(50 psi)	(> 50 psi)		4 BD
(0 ... 30 psi)		(-5.8 psi)	(80 psi)	(> 80 psi)		4 BE
(0 ... 60 psi)		(-11.5 psi)	(140 psi)	(> 140 psi)		4 BF
(0 ... 100 psi)		(-14.5 psi)	(200 psi)	(> 200 psi)		4 BG
(0 ... 150 psi)		(-14.5 psi)	(350 psi)	(> 350 psi)		4 CA
(0 ... 200 psi)		(-14.5 psi)	(550 psi)	(> 550 psi)		4 CB
(0 ... 300 psi)		(-14.5 psi)	(800 psi)	(> 800 psi)		4 CD
(0 ... 500 psi)		(-14.5 psi)	(1400 psi)	(> 1400 psi)		4 CE
(0 ... 750 psi)		(-14.5 psi)	(2000 psi)	(> 2000 psi)		4 CF
(0 ... 1000 psi)		(-14.5 psi)	(2000 psi)	(> 2000 psi)		4 CG
Other version, add order code and plain text: Measuring range: ... up to ... psi						9 AA H 1 Y
Measuring ranges for absolute pressure (only for US market)						
(0 ... 10 psia)		(0 psia)	(35 psia)	(> 35 psia)		6 AG
(0 ... 15 psia)		(0 psia)	(35 psia)	(> 35 psia)		6 BA
(0 ... 20 psia)		(0 psia)	(50 psia)	(> 50 psia)		6 BB
(0 ... 30 psia)		(0 psia)	(80 psia)	(> 80 psia)		6 BD
(0 ... 60 psia)		(0 psia)	(140 psia)	(> 140 psia)		6 BE
(0 ... 100 psia)		(0 psia)	(200 psia)	(> 200 psia)		6 BG
(0 ... 150 psia)		(0 psia)	(350 psia)	(> 350 psia)		6 CA
(0 ... 200 psia)		(0 psia)	(550 psia)	(> 550 psia)		6 CB
(0 ... 300 psia)		(0 psia)	(800 psia)	(> 800 psia)		6 CC
Other version, add order code and plain text: Measuring range: ... up to ... psia						9 AA H 1 Y
▶ Available ex stock						

Pressure Measurement

Transmitters for basic requirements

SITRANS P200 for gauge and absolute pressure

1

Selection and ordering data	Order No.	Order code
SITRANS P 200 pressure transmitters for pressure and absolute pressure for general applications Accuracy typ. 0.25 % Wetted parts materials: Ceramic and stainless steel + sealing material Non-wetted parts materials: stainless steel	7MF1565 -	
Output signal 4 ... 20 mA; two-wire system; power supply 7 ... 33 V DC (10 ... 30 V DC for ATEX versions) ▶ 0 ... 10 V; three-wire system; power supply 12 ... 33 V DC ▶	0 10	
Explosion protection (only 4 ... 20 mA) None ▶ With explosion protection Ex ia IIC T4 ▶	0 1	
Electrical connection Connector per DIN EN 175301-803-A, stuffing box thread M16 (with coupling) ▶ Round connector M12 per DIN EN 60139-9 (not for gauge pressure ranges ≤ 16 bar) Connection via fixed mounted cable, 2m (not for type of protection "Intrinsic safety i") Quickon cable quick screw connection PG9 (not for type of protection "Intrinsic safety i") Connector per DIN EN 175301-803-A, stuffing box thread 1/2"-14 NPT (with coupling) Connector per DIN EN 175301-803-A, stuffing box thread PG11 (with coupling) Special version	1 2 03 04 5 6 9	N1Y
Process connection G1/2" male per EN 837-1 (1/2" BSP male) (standard for metric pressure ranges mbar, bar) ▶ G1/2" male thread and G1/8" female thread G1/4" male per EN 837-1 (1/4" BSP male) 7/16"-20 UNF male 1/4"-18 NPT male (standard for pressure ranges inH ₂ O and psi) 1/4"-18 NPT female 1/2"-14 NPT male 1/2"-14 NPT female 7/16"-20 UNF female M20x1.5 male Special version	A B C D E F G H J P Z	P1Y
Sealing material between sensor and enclosure Viton (FPM, standard) ▶ Neoprene (CR) Perbunan (NBR) EPDM Special version	A B C D Z	Q1Y
Version Standard version ▶		1
Further designs Supplement the order no. with "-Z" and add order code. Manufacturer's test certificate M per IEC 60770-2 (calibration certificate) supplied Oxygen application, oil and grease-free cleaning (only in conjunction with the sealing material Viton between sensor and enclosure and not with explosion protection version) ▶ Available ex stock		C11 E10

Pressure Measurement

Transmitters for basic requirements

SITRANS P200
for gauge and absolute pressure

1

Dimensional drawings

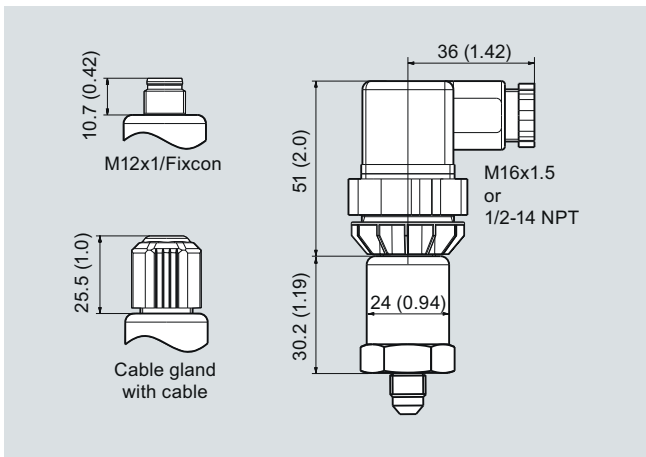

SITRANS P200, electrical connections, dimensions in mm (inch)

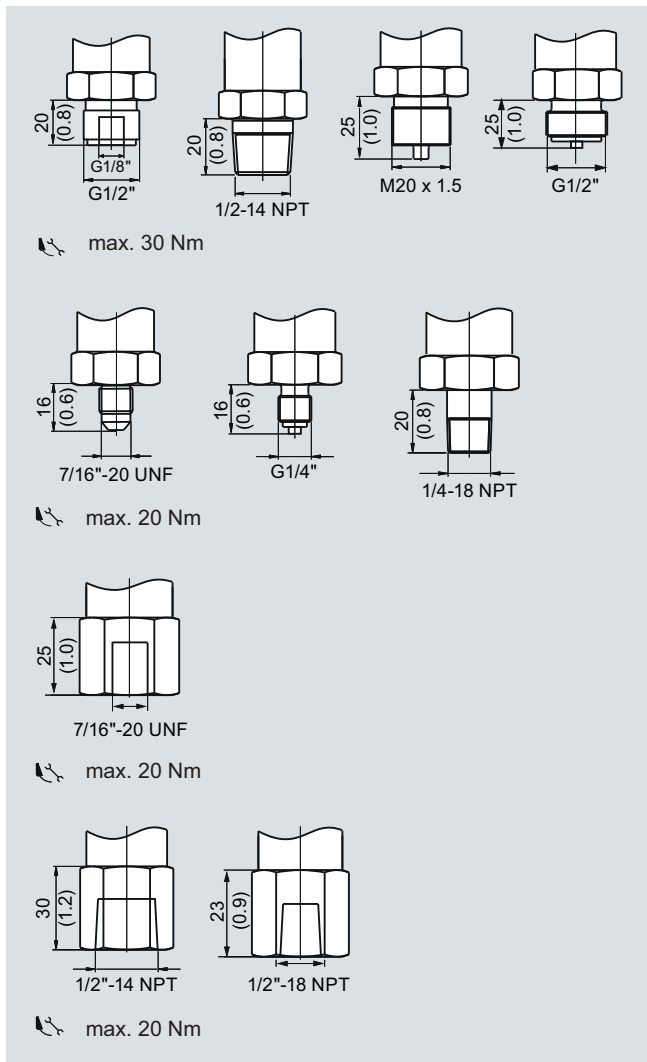

SITRANS P200, process connections, dimensions in mm (inch)

Pressure Measurement

Transmitters for basic requirements

SITRANS P200
for gauge and absolute pressure

1

Schematics

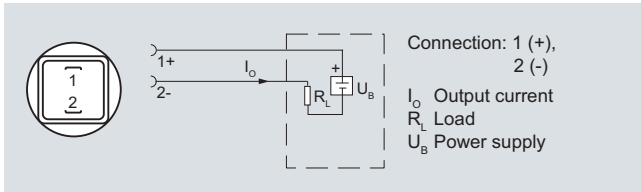

Connection with current output and connector per EN 175301

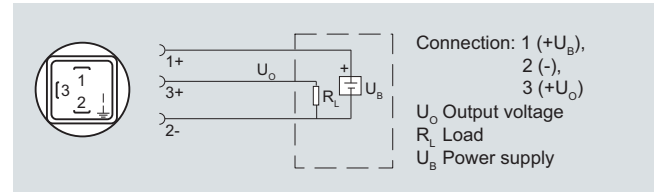

Connection with voltage output and connector per EN 175301

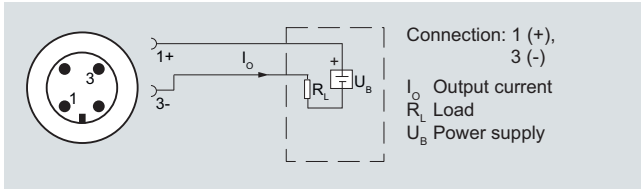

Connection with current output and connector M12x1

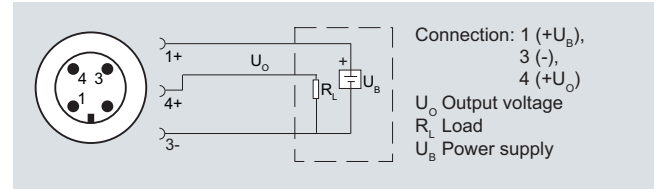

Connection with voltage output and connector M12x1

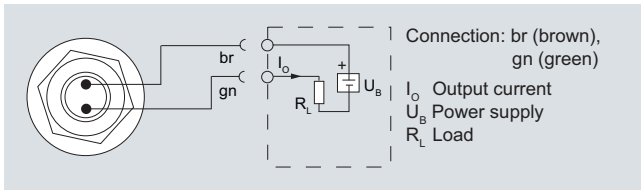

Connection with current output and cable

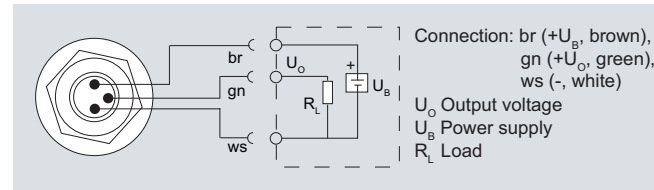

Connection with voltage output and cable

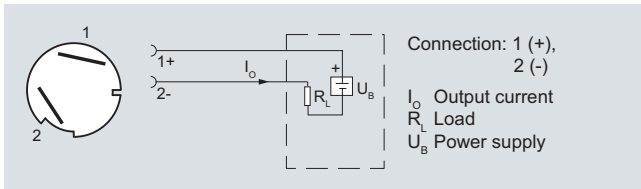

Connection with current output and Quickon cable quick screw connection

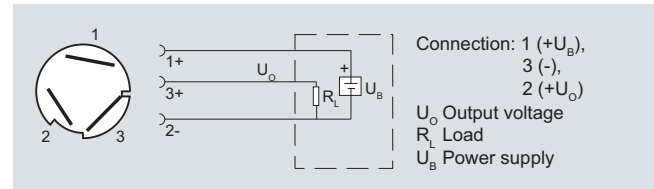

Connection with voltage output and Quickon cable quick screw connection

Version with explosion protection: 4 ... 20 mA

The grounding connection is conductively bonded to the transmitter enclosure

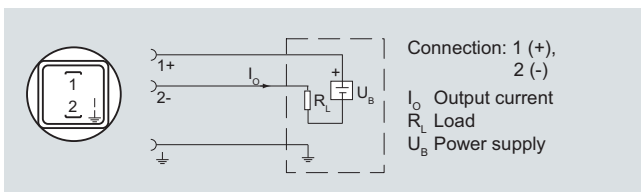

Connection with current output and connector per EN 175301 (Ex)

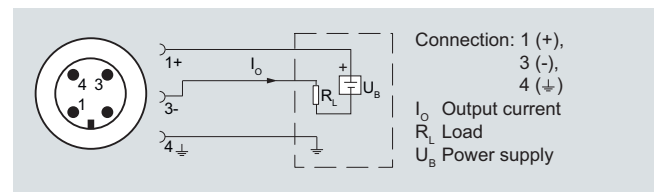

Connection with current output and connector M12x1 (Ex)

Pressure Measurement

Transmitters for basic requirements

SITRANS P210
for gauge pressure

1

Overview



The pressure transmitter SITRANS P210 measures the gauge pressure of liquids, gases and vapors.

- Stainless steel measuring cell
- Measuring ranges 100 to 600 mbar (1.45 to 8.7 psi) relative
- For low-pressure applications

Benefits

- High measuring accuracy
- Rugged stainless steel enclosure
- High overload withstand capability
- For aggressive and non-aggressive media
- For measuring the pressure of liquids, gases and vapors
- Compact design

Application

The pressure transmitter SITRANS P210 for gauge pressure is used in the following industrial areas:

- Mechanical engineering
- Shipbuilding
- Power engineering
- Chemical industry
- Water supply

Design

Device structure without explosion protection

The pressure transmitter consists of a piezoresistive measuring cell with a diaphragm installed in a stainless steel enclosure. It can be used with a connector per EN 175301-803-A (IP65), a round plug M12 (IP67), a cable (IP67) or a Quickon cable quick screw connection (IP67) connected electrically. The output signal is between 4 and 20 mA or 0 and 10 V.

Device structure with explosion protection

The pressure transmitter consists of a piezoresistive measuring cell with a diaphragm installed in a stainless steel enclosure. It can be used with a connector per EN 175301-803-A (IP65) or a round plug M12 (IP67) connected electrically. The output signal is between 4 and 20 mA.

Function

The pressure transmitter measures the gauge pressure of liquids and gases as well as the level of liquids.

Mode of operation

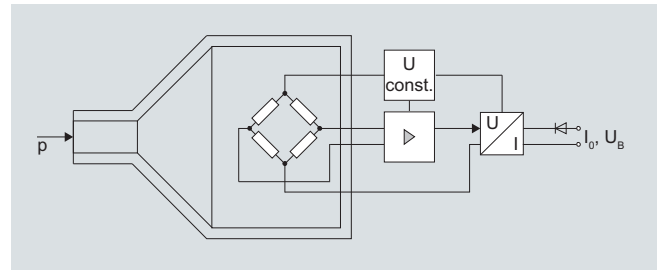

SITRANS P210 pressure transmitters (7MF1566-...), functional diagram

The stainless steel measuring cell has a thin-film resistance bridge to which the operating pressure p is transmitted through a stainless steel diaphragm.

The voltage output from the measuring cell is converted by an amplifier into an output current of 4 to 20 mA or an output voltage of 0 to 10 V DC.

The output current and voltage are linearly proportional to the input pressure.

Pressure Measurement

Transmitters for basic requirements

SITRANS P210 for gauge pressure

1

Technical specifications

Application	
Gauge measurement	Liquids, gases and vapors
Mode of operation	
Measuring principle	Piezoresistive measuring cell (stainless steel diaphragm)
Measured variable	Gauge pressure
Inputs	
Measuring range	
• Gauge pressure	100 ... 600 mbar (1.5 ... 8.7 psi)
Output	
Current signal	4 ... 20 mA
• Load	($U_B - 10 \text{ V}$) / 0.02 A
• Auxiliary power U_B	DC 7 ... 33 V (10 ... 30 V for Ex)
Voltage signal	0 ... 10 V DC
• Load	$\geq 10 \text{ k}\Omega$
• Auxiliary power U_B	12 ... 33 V DC
• Power consumption	< 7 mA at 10 k Ω
Characteristic curve	Linear rising
Measuring accuracy	
Error in measurement at limit setting incl. hysteresis and reproducibility	<ul style="list-style-type: none"> • Typical: 0.25 % of full-scale value • Maximum: 0.5 % of full-scale value
Step response time T_{99}	< 5 ms
Long-term stability	
• Lower range value and measuring span	0.25 % of full-scale value/year
Influence of ambient temperature	
• Lower range value and measuring span	<ul style="list-style-type: none"> • 0.25 %/10 K of full-scale value • 0.5 %/10K of full-scale value for a measuring range 100 ... 400 mbar
• Influence of power supply	0.005 %/V
Conditions of use	
Process temperature with gasket made of:	
• FPM (Standard)	-15 ... +125 °C (+5 ... +257 °F)
• Neoprene	-35 ... +100 °C (-31 ... +212 °F)
• Perbunan	-20 ... +100 °C (-4 ... +212 °F)
• EPDM	-40 ... +145 °C (-40 ... +293 °F), usable for drinking water
Ambient temperature	-25 ... +85 °C (-13 ... +185 °F)
Storage temperature	-50 ... +100 °C (-58 ... +212 °F)
Degree of protection (to EN 60529)	<ul style="list-style-type: none"> • IP 65 with connector per EN 175301-803-A • IP 67 with M12 connector • IP 67 with cable • IP 67 with cable quick screw connection
Electromagnetic compatibility	<ul style="list-style-type: none"> • acc. EN 61326-1/-2/-3 • acc. NAMUR NE21, only for ATEX versions and with a max. measuring deviation $\leq 1 \%$
Mounting position	upright

Design

Weight	Approx. 0.090 kg (0.198 lb)
Process connections	See dimension drawings
Electrical connections	<ul style="list-style-type: none"> • Connector per EN 175301-803-A Form A with cable inlet M16x1.5 or 1/2-14 NPT or Pg 11 • M12 connector • 2 or 3-wire (0.5 mm²) cable ($\varnothing \pm 5.4 \text{ mm}$) • Quickon cable quick screw connection
Wetted parts materials	
• Measuring cell	Stainless steel, mat.-No. 1.4435
• Process connection	Stainless steel, mat. No. 1.4404 (SST 316 L)
• Gasket	<ul style="list-style-type: none"> • FPM (Standard) • Neoprene • Perbunan • EPDM
Non-wetted parts materials	
• Enclosure	Stainless steel, mat. No. 1.4404 (SST 316 L)
• Rack	Plastic
• cables	PVC

Certificates and approvals

Classification according to pressure equipment directive (PED 97/23/EC)	For gases of fluid group 1 and liquids of fluid group 1; meets requirements as per article 3, paragraph 3 (good engineering practice)
Lloyd's Register of Shipping (LR)	12/20010
Germanischer Lloyd (GL)	GL19740 11 HH00
American Bureau of Shipping (ABS)	ABS_11_HG 789392_PDA
Bureau Veritas (BV)	BV 271007A0 BV
Det Norske Veritas (DNV)	A 12553
Drinking water approval (ACS)	ACS 11 ACC NY 055
GOST	GOST-R
Underwriters Laboratories (UL)	
• for USA and Canada	UL 20110217 - E34453
• worldwide	IEC UL DK 21845

Explosion protection

Intrinsic safety "i" (only with current output)	Ex II 1/2 G Ex ia IIC T4 Ga/Gb Ex II 1/2 D Ex ia IIIC T125 °C Da/Db
EC type-examination certificate	SEV 10 ATEX 0146
Connection to certified intrinsically-safe resistive circuits with maximum values:	$U_i \leq 30 \text{ V DC}$; $I_i \leq 100 \text{ mA}$; $P_i \leq 0.75 \text{ W}$
Effective internal inductance and capacity for versions with plugs per EN 175301-803-A and M12	$L_i = 0 \text{ nH}$; $C_i = 0 \text{ nF}$

Pressure Measurement

Transmitters for basic requirements

SITRANS P210
 for gauge pressure

1

Selection and ordering data					Order No.	Order code
SITRANS P 210 pressure transmitters for gauge pressure for low pressure applications					7MF1566-	
Accuracy typ. 0.25 %						
Wetted parts materials: Stainless steel + sealing material						
Non-wetted parts materials: stainless steel						
Measuring range	Overload limit		Burst pressure			
	min.	max.				
For gauge pressure						
0...100 mbar (1.45 psi)	-400 mbar (-5.8 psi)	400 mbar (5.8 psi)	1 bar (14.5 psi)	▶	3 AA	
0...160 mbar (2.32 psi)	-400 mbar (-5.8 psi)	400 mbar (5.8 psi)	1 bar (14.5 psi)	▶	3 AB	
0...250 mbar (3.63 psi)	-800 mbar (-11.6 psi)	1000 mbar (14.5 psi)	2 bar (29.0 psi)	▶	3 AC	
0...400 mbar (5.8 psi)	-800 mbar (-11.6 psi)	1000 mbar (14.5 psi)	2 bar (29.0 psi)	▶	3 AD	
0...600 mbar (8.7 psi)	-1000 mbar (-14.5 psi)	2000 mbar (29.0 psi)	3 bar (43.5 psi)	▶	3 AG	
Other version, add order code and plain text:					9 AA	H 1 Y
Measuring range: ... up to ... mbar (psi)						
Output signal						
4 ... 20 mA; two-wire system; power supply 7 ... 33 V DC (10 ... 30 V DC for ATEX versions)					▶	0
0 ... 10 V; three-wire system; power supply 12 ... 33 V DC					▶	10
Explosion protection (only 4 ... 20 mA)						
None					▶	0
With explosion protection Ex ia IIC T4					▶	1
Electrical connection						
Connector per DIN EN 175301-803-A, stuffing box thread M16 (with coupling)					▶	1
Connection via fixed mounted cable, 2 m (not for type of protection "Intrinsic safety i")					▶	0 3
Quickon cable quick screw connection PG9 (not for type of protection "Intrinsic safety i")					▶	0 4
Connector per DIN EN 175301-803-A, stuffing box thread 1/2"-14 NPT (with coupling)					▶	5
Connector per DIN EN 175301-803-A, stuffing box thread PG11 (with coupling)					▶	6
Special version					▶	9
Process connection						
G1/2" male per EN 837-1 (1/2" BSP male) (standard for metric pressure ranges mbar, bar)					▶	A
G1/2" male thread and G1/8" female thread					▶	B
G1/4" male per EN 837-1 (1/4" BSP male)					▶	C
7/16"-20 UNF male					▶	D
1/4"-18 NPT male (standard for pressure ranges inH ₂ O and psi)					▶	E
1/4"-18 NPT female					▶	F
1/2"-14 NPT male					▶	G
1/2"-14 NPT female					▶	H
7/16"-20 UNF female					▶	J
M20x1.5 male					▶	P
Special version					▶	Z
						P 1 Y
Sealing material between sensor and enclosure						
Viton (FPM, standard)					▶	A
Neoprene (CR)					▶	B
Perbunan (NBR)					▶	C
EPDM					▶	D
Special version					▶	Z
						Q 1 Y
Version						
Standard version					▶	1
Further designs						
Supplement the order no. with "-Z" and add order code.						
Manufacturer's test certificate M per IEC 60770-2 (calibration certificate) supplied						
▶ Available ex stock						
					C11	

Pressure Measurement

Transmitters for basic requirements

SITRANS P210 for gauge pressure

1

Dimensional drawings

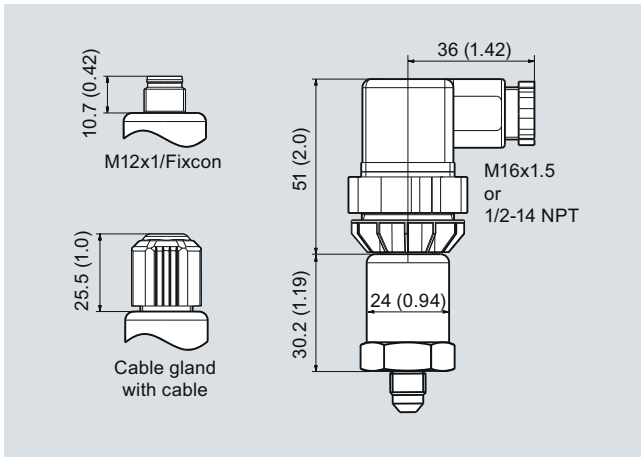

SITRANS P210, electrical connections, dimensions in mm (inch)

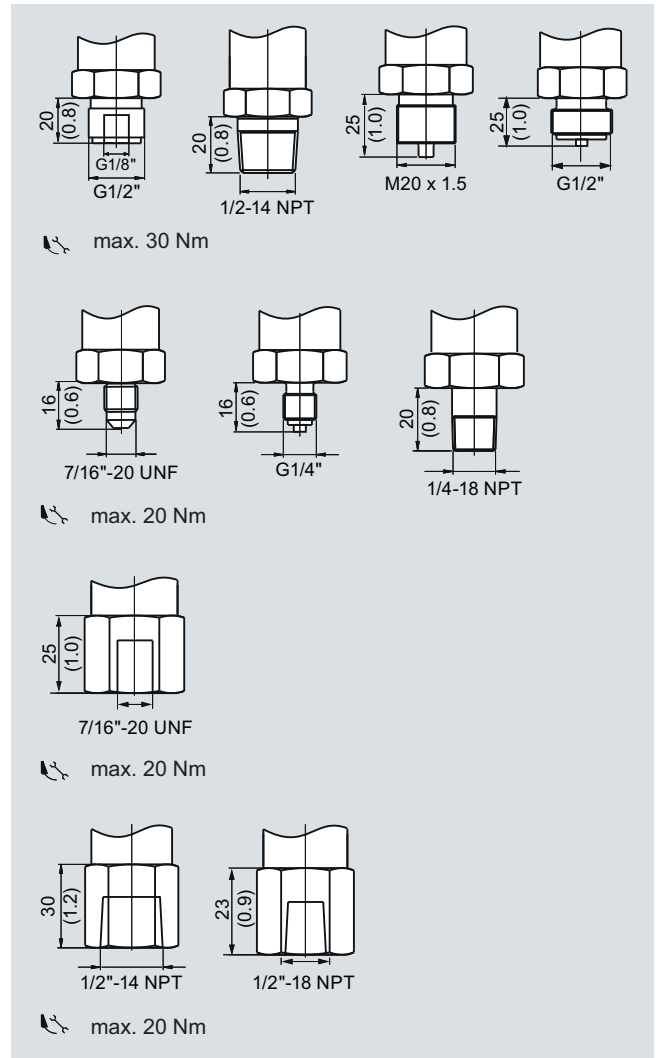

SITRANS P210, process connections, dimensions in mm (inch)

Pressure Measurement

Transmitters for basic requirements

SITRANS P210
for gauge pressure

1

Schematics

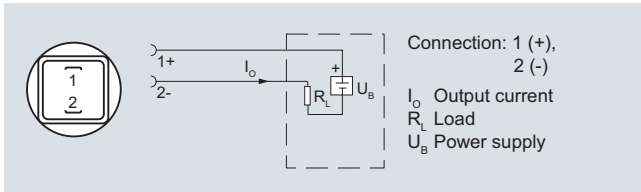

Connection with current output and connector per EN 175301

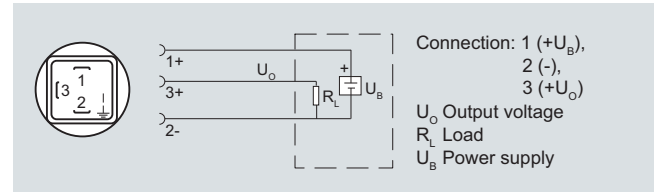

Connection with voltage output and connector per EN 175301

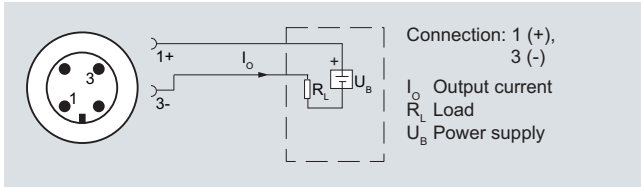

Connection with current output and connector M12x1

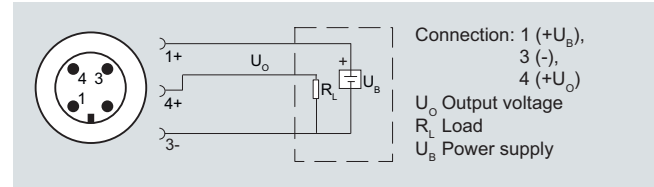

Connection with voltage output and connector M12x1

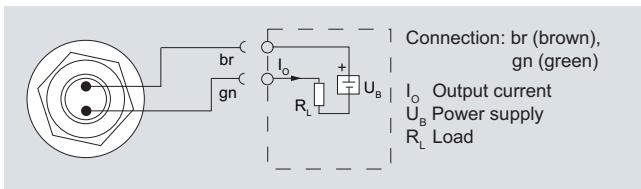

Connection with current output and cable

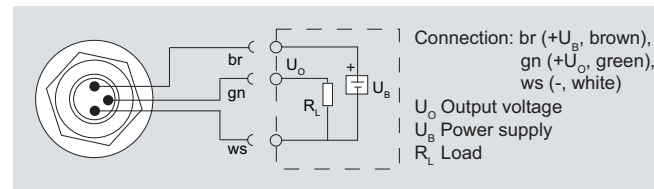

Connection with voltage output and cable

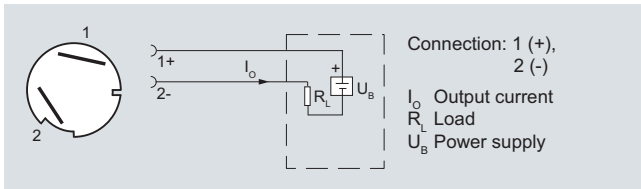

Connection with current output and Quickon cable quick screw connection

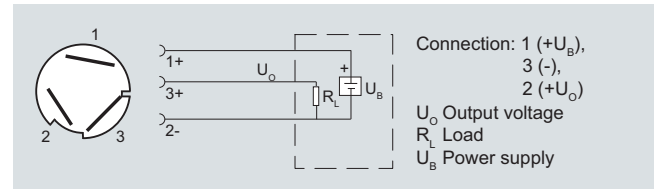

Connection with voltage output and Quickon cable quick screw connection

Version with explosion protection: 4 ... 20 mA

The grounding connection is conductively bonded to the transmitter enclosure

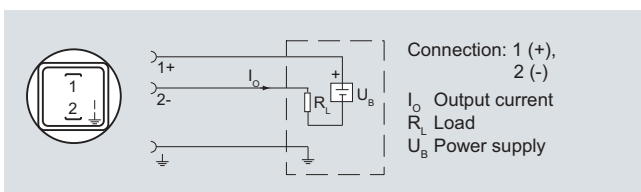

Connection with current output and connector per EN 175301 (Ex)

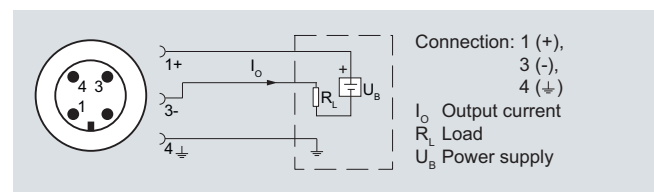

Connection with current output and connector M12x1 (Ex)

Pressure Measurement

Transmitters for basic requirements

SITRANS P220 for gauge pressure

1

Overview



The pressure transmitter SITRANS P220 measures the gauge pressure of liquids, gases and vapors.

- Stainless steel measuring cell, fully welded
- Measuring ranges 2.5 to 600 bar (36.3 to 8702 psi) relative
- For high-pressure applications and refrigeration technology division

Benefits

- High measuring accuracy
- Rugged stainless steel enclosure
- High overload withstand capability
- For aggressive and non-aggressive media
- For measuring the pressure of liquids, gases and vapors
- Compact design
- Gasket-less

Application

The pressure transmitter SITRANS P220 for gauge pressure is used in the following industrial areas:

- Mechanical engineering
- Shipbuilding
- Power engineering
- Chemical industry
- Water supply

Design

Device structure without explosion protection

The pressure transmitter consists of a piezoresistive measuring cell with a diaphragm installed in a stainless steel enclosure. It can be used with a connector per EN 175301-803-A (IP65), a round plug M12 (IP67), a cable (IP67) or a Quickon cable quick screw connection (IP67) connected electrically. The output signal is between 4 and 20 mA or 0 and 10 V.

Device structure with explosion protection

The pressure transmitter consists of a piezoresistive measuring cell with a diaphragm installed in a stainless steel enclosure. It can be used with a connector per EN 175301-803-A (IP65) or a round plug M12 (IP67) connected electrically. The output signal is between 4 and 20 mA.

Function

The pressure transmitter measures the gauge pressure of liquids and gases as well as the level of liquids.

Mode of operation

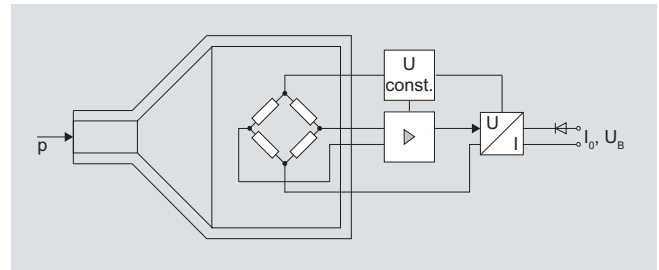

SITRANS P220 pressure transmitters (7MF1567-...), functional diagram

The stainless steel measuring cell has a thick-film resistance bridge to which the operating pressure p is transmitted through a stainless steel diaphragm.

The voltage output from the measuring cell is converted by an amplifier into an output current of 4 to 20 mA or an output voltage of 0 to 10 V DC.

The output current and voltage are linearly proportional to the input pressure.

Pressure Measurement

Transmitters for basic requirements

SITRANS P220
for gauge pressure

1

Technical specifications

Application	
Gauge pressure measurement	Liquids, gases and vapors
Mode of operation	
Measuring principle	Piezoresistive measuring cell (stainless steel diaphragm)
Measured variable	Gauge pressure
Inputs	
Measuring range	
• Gauge pressure	
- Metric	2.5 ... 600 bar (36 ... 8700 psi)
- US measuring range	30... 8700 psi
Output	
Current signal	4 ... 20 mA
• Load	$(U_B - 10 \text{ V}) / 0.02 \text{ A}$
• Auxiliary power U_B	DC 7 ... 33 V (10 ... 30 V for Ex)
Voltage signal	0 ... 10 V DC
• Load	$\geq 10 \text{ k}\Omega$
• Auxiliary power U_B	12 ... 33 V DC
• Power consumption	$< 7 \text{ mA}$ at 10 k Ω
Characteristic curve	Linear rising
Measuring accuracy	
Error in measurement at limit setting incl. hysteresis and reproducibility	<ul style="list-style-type: none"> • Typical: 0.25 % of full-scale value • Maximum: 0.5 % of full-scale value
Step response time T_{99}	$< 5 \text{ ms}$
Long-term stability	
• Lower range value and measuring span	0.25 % of full-scale value/year
Influence of ambient temperature	
• Lower range value and measuring span	0.25 %/10 K of full-scale value
• Influence of power supply	0.005 %/V
Conditions of use	
• Process temperature	-30 ... +120 °C (-22 ... +248 °F)
• Ambient temperature	-25 ... +85 °C (-13 ... +185 °F)
• Storage temperature	-50 ... +100 °C (-58 ... +212 °F)
• Degree of protection (to EN 60529)	<ul style="list-style-type: none"> • IP 65 with connector per EN 175301-803-A • IP 67 with M12 connector • IP 67 with cable • IP 67 with cable quick screw connection
Electromagnetic compatibility	<ul style="list-style-type: none"> • acc. EN 61326-1/-2/-3 • acc. NAMUR NE21, only for ATEX versions and with a max. measuring deviation $\leq 1 \%$

Design	
Weight	Approx. 0.090 kg (0.198 lb)
Process connections	See dimension drawings
Electrical connections	<ul style="list-style-type: none"> • Connector per EN 175301-803-A Form A with cable inlet M16x1.5 or 1/2-14 NPT or Pg 11 • M12 connector • 2 or 3-wire (0.5 mm²) cable ($\varnothing \pm 5.4 \text{ mm}$) • Quickon cable quick screw connection
Wetted parts materials	
• Measuring cell	Stainless steel, mat.-No. 1.4016
• Process connection	Stainless steel, mat. No. 1.4404 (SST 316 L)
Non-wetted parts materials	
• Enclosure	Stainless steel, mat. No. 1.4404 (SST 316 L)
• Rack	Plastic
• cables	PVC
Certificates and approvals	
Classification according to pressure equipment directive (PED 97/23/EC)	For gases of fluid group 1 and liquids of fluid group 1; complies with requirements of article 3, paragraph 3 (sound engineering practice)
Lloyd's Register of Shipping (LR)	12/20010
Germanischer Lloyd (GL)	GL19740 11 HH00
American Bureau of Shipping (ABS)	ABS_11_HG 789392_PDA
Bureau Veritas (BV)	BV 271007A0 BV
Det Norske Veritas (DNV)	A 12553
Drinking water approval (ACS)	ACS 11 ACC NY 055
GOST	GOST-R
Underwriters Laboratories (UL)	
• for USA and Canada	UL 20110217 - E34453
• worldwide	IEC UL DK 21845
Explosion protection	
Intrinsic safety "i" (only with current output)	Ex II 1/2 G Ex ia IIC T4 Ga/Gb Ex II 1/2 D Ex ia IIIC T125 °C Da/Db
EC type-examination certificate	SEV 10 ATEX 0146
Connection to certified intrinsically-safe resistive circuits with maximum values:	$U_i \leq 30 \text{ V DC}$; $I_i \leq 100 \text{ mA}$; $P_i \leq 0.75 \text{ W}$
Effective internal inductance and capacity for versions with plugs per EN 175301-803-A and M12	$L_i = 0 \text{ nH}$; $C_i = 0 \text{ nF}$

Pressure Measurement

Transmitters for basic requirements

SITRANS P220 for gauge pressure

1

Selection and ordering data

Order No.

Order code

SITRANS P 220 pressure transmitters for gauge pressure, high-pressure and refrigeration applications, fully-welded version

7MF1567- - - A

Accuracy typ. 0.25 %

Wetted parts materials: stainless steel

Non-wetted parts materials: stainless steel

Measuring range	Overload limit		Burst pressure	
	Mini- mum	Max.		
For gauge pressure				
0 ... 2.5 bar (0 ... 36.3 psi)	-0.8 bar (-11.6 psi)	6.25 bar (90.7 psi)	25 bar (363 psi)	▶ 3BD
0 ... 4 bar (0 ... 58 psi)	-0.8 bar (-11.6 psi)	10 bar (145 psi)	40 bar (870 psi)	▶ 3BE
0 ... 6 bar (0 ... 87 psi)	-1 bar (-14.5 psi)	15 bar (217 psi)	60 bar (870 psi)	▶ 3BG
0 ... 10 bar (0 ... 145 psi)	-1 bar (-14.5 psi)	25 bar (362 psi)	60 bar (870 psi)	▶ 3CA
0 ... 16 bar (0 ... 232 psi)	-1 bar (-14.5 psi)	40 bar (580 psi)	96 bar (1392 psi)	▶ 3CB
0 ... 25 bar (0 ... 363 psi)	-1 bar (-14.5 psi)	62.5 bar (906 psi)	150 bar (2176 psi)	▶ 3CD
0 ... 40 bar (0 ... 580 psi)	-1 bar (-14.5 psi)	100 bar (1450 psi)	240 bar (3481 psi)	▶ 3CE
0 ... 60 bar (0 ... 870 psi)	-1 bar (-14.5 psi)	150 bar (2175 psi)	360 bar (5221 psi)	▶ 3CG
0 ... 100 bar (0 ... 1450 psi)	-1 bar (-14.5 psi)	250 bar (3625 psi)	600 bar (8702 psi)	▶ 3DA
0 ... 160 bar (0 ... 2320 psi)	-1 bar (-14.5 psi)	400 bar (5801 psi)	960 bar (13924 psi)	▶ 3DB
0 ... 250 bar (0 ... 3625 psi)	-1 bar (-14.5 psi)	625 bar (9064 psi)	1500 bar (21756 psi)	▶ 3DD
0 ... 400 bar (0 ... 5801 psi)	-1 bar (-14.5 psi)	1000 bar (14503 psi)	2400 bar (34809 psi)	▶ 3DE
0 ... 600 bar (0 ... 8702 psi)	-1 bar (-14.5 psi)	1500 bar (21755 psi)	2500 bar (36260 psi)	▶ 3DG

Other version, add order code and plain text:

Measuring range: ... up to ... bar (psi)

9AA H1Y

Measuring ranges for gauge pressure (only for US market)

(0 ... 30 psi)	(-5.8 psi)	(75 psi)	(360 psi)	4BE
(0 ... 60 psi)	(-11.5 psi)	(150 psi)	(580 psi)	4BF
(0 ... 100 psi)	(-14.5 psi)	(250 psi)	(580 psi)	4BG
(0 ... 150 psi)	(-14.5 psi)	(375 psi)	(870 psi)	4CA
(0 ... 200 psi)	(-14.5 psi)	(500 psi)	(1390 psi)	4CB
(0 ... 300 psi)	(-14.5 psi)	(750 psi)	(2170 psi)	4CD
(0 ... 500 psi)	(-14.5 psi)	(1250 psi)	(3480 psi)	4CE
(0 ... 750 psi)	(-14.5 psi)	(1875 psi)	(5220 psi)	4CF
(0 ... 1000 psi)	(-14.5 psi)	(2500 psi)	(5220 psi)	4CG
(0 ... 1500 psi)	(-14.5 psi)	(3750 psi)	(8700 psi)	4DA
(0 ... 2000 psi)	(-14.5 psi)	(5000 psi)	(13920 psi)	4DB
(0 ... 3000 psi)	(-14.5 psi)	(7500 psi)	(21750 psi)	4DD
(0 ... 5000 psi)	(-14.5 psi)	(12500 psi)	(34800 psi)	4DE
(0 ... 6000 psi)	(-14.5 psi)	(15000 psi)	(34800 psi)	4DF
(0 ... 8700 psi)	(-14.5 psi)	(21000 psi)	(52200 psi)	4DG

Other version, add order code and plain text: Measuring range: ... up to ... psi

9AA H1Y

Output signal

4 ... 20 mA; two-wire system; power supply 7 ... 33 V DC (10 ... 30 V DC for ATEX versions) ▶

0

0 ... 10 V; three-wire system; power supply 12 ... 33 V DC ▶

10

Explosion protection (only 4 ... 20 mA)

None ▶

0

With explosion protection Ex ia IIC T4 ▶

1

Electrical connection

Connector per DIN EN 175301-803-A, stuffing box thread M16 (with coupling) ▶

1

Round connector M12 per DIN EN 60139-9 (not for gauge pressure ranges ≤ 16 bar)

2

Connection via fixed mounted cable, 2 m (not for type of protection "Intrinsic safety i")

0 3

Quickon cable quick screw connection PG9 (not for type of protection "Intrinsic safety i")

0 4

Connector per DIN EN 175301-803-A, stuffing box thread 1/2"-14 NPT (with coupling)

5

Connector per DIN EN 175301-803-A, stuffing box thread PG11 (with coupling)

6

Special version

9

N1Y

▶ Available ex stock

Pressure Measurement

Transmitters for basic requirements

SITRANS P220
 for gauge pressure

1

Selection and ordering data	Order No.	Order code
SITRANS P 220 pressure transmitters for gauge pressure, high-pressure and refrigeration applications, fully-welded version Accuracy typ. 0.25 % Wetted parts materials: stainless steel Non-wetted parts materials: stainless steel	7MF1567 - - - - -	A
Process connection G½" male per EN 837-1 (½" BSP male) (standard for metric pressure ranges mbar, bar) ▶ G½" male thread and G1/8" female thread G¼" male per EN 837-1 (¼" BSP male) 7/16"-20 UNF male ¼"-18 NPT male (standard for pressure ranges inH ₂ O and psi) ¼"-18 NPT female (Only for measuring ranges ≤ 60 bar (870 psi)) ½"-14 NPT male ½"-14 NPT female (Only for measuring ranges ≤ 60 bar (870 psi)) 7/16"-20 UNF female M20x1.5 male Special version		A B C D E F G H J P Z P 1 Y
Version Standard version ▶		1
Further designs Supplement the order no. with "-Z" and add order code. Manufacturer's test certificate M per IEC 60770-2 (calibration certificate) supplied Oxygen application, oil and grease-free cleaning (Not in conjunction with explosion protection version) ▶ Available ex stock	C11 E10	

Pressure Measurement

Transmitters for basic requirements

SITRANS P220 for gauge pressure

1

Dimensional drawings

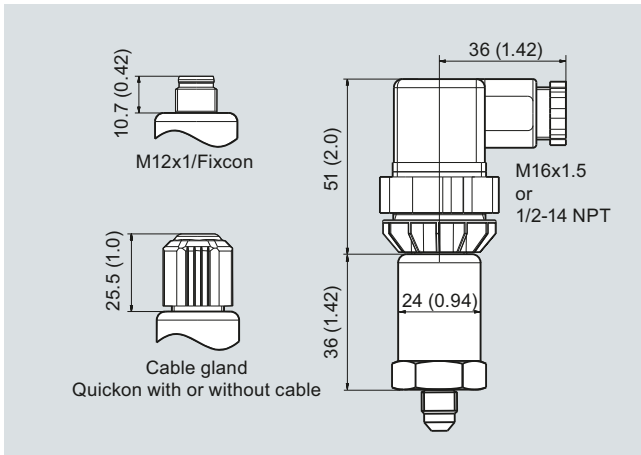

SITRANS P220, electrical connections, dimensions in mm (inch)

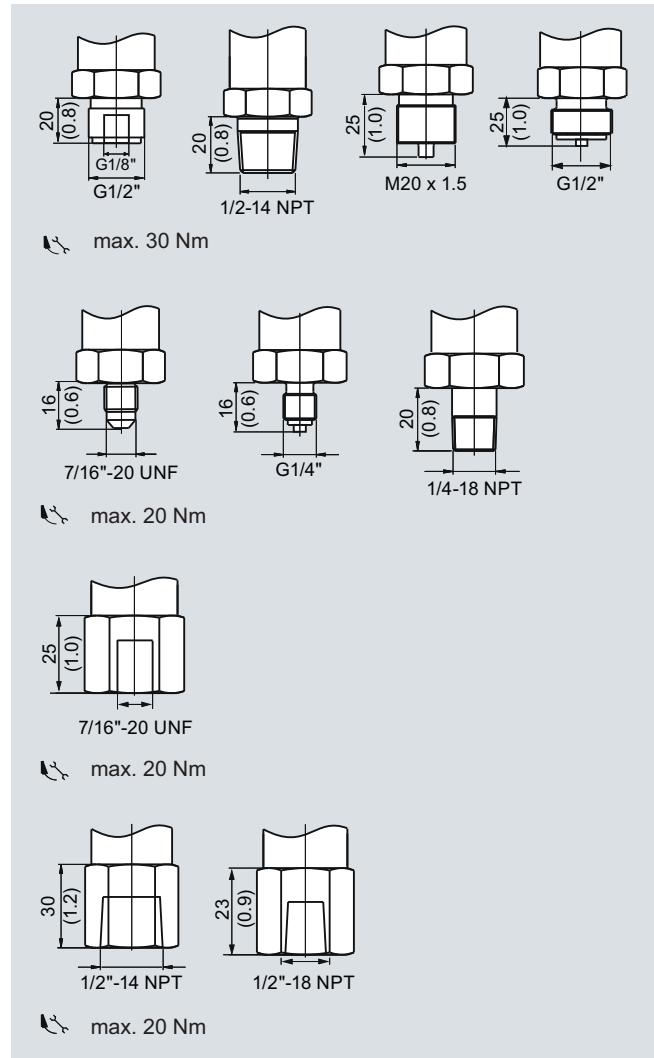

SITRANS P220, process connections, dimensions in mm (inch)

Pressure Measurement

Transmitters for basic requirements

SITRANS P220
for gauge pressure

1

Schematics

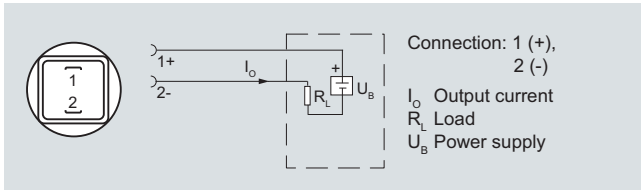

Connection with current output and connector per EN 175301

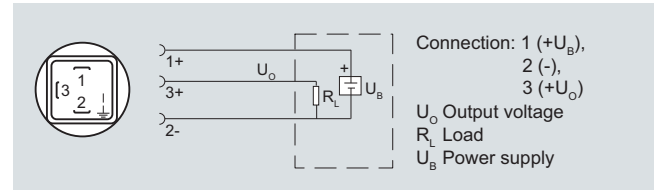

Connection with voltage output and connector per EN 175301

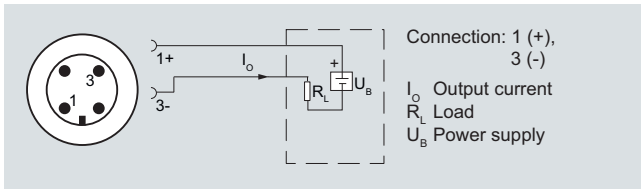

Connection with current output and connector M12x1

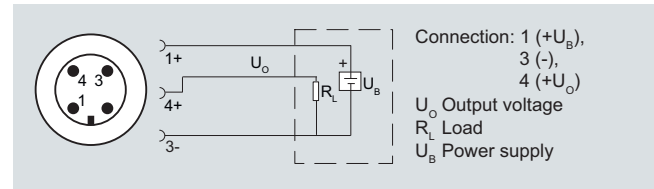

Connection with voltage output and connector M12x1

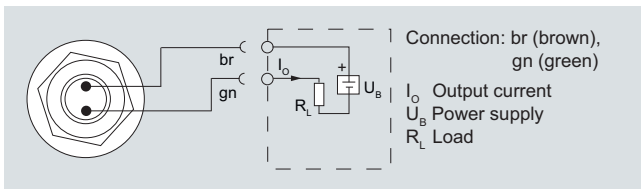

Connection with current output and cable

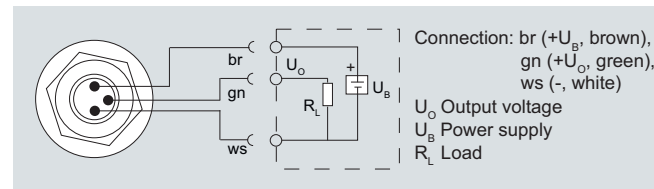

Connection with voltage output and cable

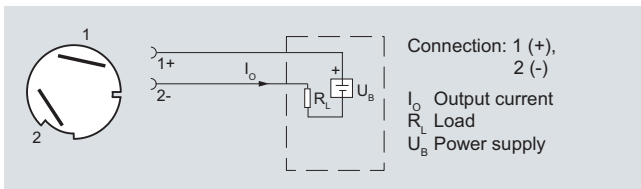

Connection with current output and cable quick screw connection
Quickon

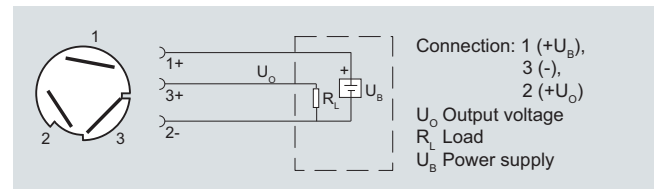

Connection with voltage output and cable quick screw connection
Quickon

Version with explosion protection: 4 ... 20 mA

The grounding connection is conductively bonded to the transmitter enclosure

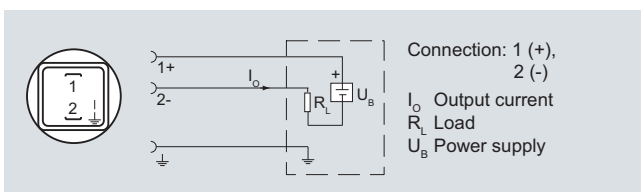

Connection with current output and connector per EN 175301 (Ex)

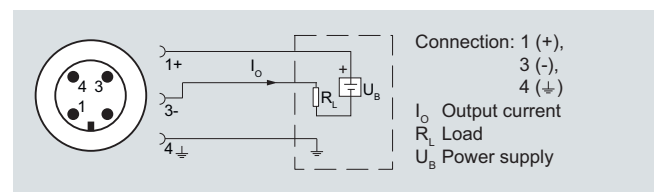

Connection with current output and connector M12x1 (Ex)