

Remote IO

C Series

User Manual

Remote IO-C Series



Odot Automation System Co., Ltd.

2020-2

Copyright ©2020 Odot Automation all rights reserved

Version

Date	Version	Content	Author
2020-02-20	V1.00	Release version	CCL
2020-03-05	V1.01	Updated CN-8031	YZJ/CCL
2020-03-19	V1.02	Updated CN-8031	CCL
2020-04-15	V1.03	Updated CN-8033 EtherCAT, CT-2228, CT-2718, CT-3158, CT-3713, CT-3804, CT-5800, CT-7221	YZJ/CCL
2020-05-29	V1.04	Updated CN-8032/CN-8033	CCL
2020-07-07	V1.05	Updated CT-5321	CCL
2020-07-09	V1.06	Updated CN-8011, CN-8012	CCL
2020-12-13	V1.12	Updated CN-8034, CT-4154, CT-4158	CCL
2021-10-08	V1.13	Updated CT-124H, CT-222H, CT-3258, CT-3808, CT-5102, CT-5112, CT-5122, CT-5142	CCL
2021-11-15	V1.14	Updated CN-8032-L	CCL
2022-04-02	V1.15	Updated CN-8021	CCL
2022-04-18	V1.16	Updated CT-1218 and CT-3168 Modify the external DI DO wiring circuits	CCL
2022-06-01	V1.17	Updated CT-5801 and CT-7220	CCL
2023-02-15	V1.18	Updated CT-1228 and CT-3268	CCL
2023-06-30	V1.19	Updated CT-2738, CT-2754, CT-3134, CT-3234, CT-3723, CT-3734, CT-3844, CT-3848, CT-5331, CT-730F, CT-731F, CT-732F, CT-7339, CT-7346	CCL
2022-12-01	V1.20	Updated CT-3734	CCL
2023-02-08	V1.21	Updated CT-5331	CCL
2023-06-30	V1.22	Updated CT-3716, CT-3726, CT-3723, CT-2738, CT-2754, CT-3134, CT-3844, CT-3848	CCL
2023-08-14	V 1.23	Updated CT-5112 sub-module and CT-2218	XWL
2023-11-27	V1.24	Updated CT-2794, CT-1314, CT-5341	QYZ
2024-01-04	V1.25	Updated CT-124D and CT-222D	QYZ
2024-04-11	V1.26	Updated CT-5224, CN-8037, CN-8032-S	QYZ/LY
2024-05-22	V1.27	Updated CN-8022, CT-221D, CT-125F, CT-126F, CT-2244, CT-225F, CT-226F, CT-3274, CT-3744, CT-	YPP/LY

		4238, CT-5212, CT-5802	
--	--	------------------------	--

Ownership rights information

Without the permission of the copyright owner, all or part of this document shall not be republished as a paper or electronic document.

Disclaimer

This document is only intended to assist the reader in using the products, and the company shall not be responsible for any loss or error caused by the use of the information in this document. The product and text described in this document are under constant development and refinement. Odot Automation System Co., Ltd. has the right to modify this document without notifying us ers.

Software download

Please log on the official website: www.odotautomation.com and click on the corresponding product page to download.

Content

Legal Statement	32
Security Information	33
About this manual	35
1 Product Overview	38
1.1 Module Feature.....	39
1.2 Module Layout.....	39
1.3 LED Indicators.....	40
1.4 Grounding.....	41
1.4.1 Functional grounding on the DIN rail.....	41
1.4.2 System Grounding.....	42
1.4.3 Protective Earthing on the backplane (PE).....	43
1.4.4 Shielded Cable Connection.....	43
1.5 Wiring.....	44
1.6 Installation.....	46
1.6.1 Installation and maintenance requirements.....	46
1.6.2 Removal.....	50
1.6.3 Installation Clearance.....	53
1.6.4 Incorrect Installation Location.....	54
1.6.5 Installation Size.....	55
1.7 Power Supply.....	56
1.8 Ventilation Requirements.....	58
1.9 Scrap Processing.....	58
1.10 Equipment maintenance and repair.....	59
1.11 UL certification.....	59
2 BUS Adapter & Network Adapter	61
CN-8011 Modbus-RTU Bus Adapter.....	61

1 Module Overview.....	61
2 Technical Parameter.....	62
3 Hardware Interface.....	64
4 Wiring.....	69
5 Process data definition.....	70
6 Configuration Parameter Definition.....	71
7 System diagnostic area.....	74
A Dimension drawing.....	78
CN-8012 Profibus-DP Bus Adapter.....	79
1 Module Overview.....	79
2 Technical Parameter.....	80
3 Hardware Interface.....	82
4 Wiring.....	86
5 Process data definition.....	88
6 Configuration Parameter Definition.....	89
A Dimension drawing.....	90
CN-8013 CC-Link Bus Adapter.....	91
1 Module Overview.....	91
2 Technical Parameter.....	92
3 Hardware Interface.....	95
4 Wiring.....	100
5 Process data definition.....	102
6 Configuration Parameter Definition.....	103
A Dimension drawing.....	105
CN-8021 CANopen Bus Adapter.....	106
1 Module Overview.....	106
2 Technical Parameter.....	107
3 Hardware Interface.....	109

4 Wiring.....	113
5 Process data definition.....	114
6 Configuration Parameter Definition.....	115
A Dimension drawing.....	117
CN-8022 DeviceNet Bus Adapter.....	118
1 Module Overview.....	118
2 Technical Parameter.....	119
3 Hardware Interface.....	121
4 Wiring.....	126
5 Process Data Definitions.....	128
6 Configuration Parameter Definitions.....	129
A Dimensional Drawings.....	129
CN-8031 Modbus TCP Network Adapter.....	131
1 Module Overview.....	131
2 Technical Parameters.....	132
3 Hardware Interface.....	134
4 Wiring.....	140
5 Process data definition.....	141
6 Configuration Parameter Definition.....	141
7 System diagnostic area.....	144
A Dimension drawing.....	149
CN-8032 Profinet Network Adapter.....	150
1 The module overview.....	150
2 Technical Parameters.....	151
3 Hardware Interface.....	153
4 Wiring.....	159
5 Process data definition.....	160
6 Configuration parameters definition.....	161

A Dimension drawing.....	163
CN-8032-L Profinet Network Adapter.....	164
1 The module overview.....	164
2 Technical Parameters.....	165
3 Hardware Interface.....	168
4 Wiring.....	174
5 Process data definition.....	175
6 Configuration parameters definition.....	176
A Dimension drawing.....	178
CN-8032-S Profinet Network Adapter.....	错误!未定义书签。
1 The module overview.....	错误!未定义书签。
2 Technical Parameters.....	错误!未定义书签。
3 Hardware Interface.....	错误!未定义书签。
4 Wiring.....	错误!未定义书签。
5 Process data definition.....	错误!未定义书签。
6 Configuration parameters definition.....	错误!未定义书签。
A Dimension drawing.....	错误!未定义书签。
CN-8033 EtherCAT Network Adapter.....	179
1 The module overview.....	179
2 Technical Parameters.....	180
3 Hardware Interface.....	182
4 Wiring.....	189
5 Process data definition.....	190
6 Configuration parameters definition.....	191
A Dimension drawing.....	192
CN-8034 Ethernet/IP Network Adapter.....	193
1 The module overview.....	193
2 Technical Parameters.....	194

3	Hardware Interface.....	196
4	Wiring.....	202
5	Process data definition.....	203
6	Configuration parameters definition.....	205
A	Dimension drawing.....	207
CN-8037	CC-Link IEFB Network Adapter.....	208
1	Module overview.....	208
2	Technical parameter.....	209
3	Hardware interface.....	211
4	Wiring.....	218
5	Process data definition.....	219
6	Configuration parameter definition.....	220
A	Dimensional drawing.....	222
3	Extended IO module	223
CT-1218	8 channels digital input/24VDC/PNP.....	223
1	Module features.....	223
2	Technical parameters.....	224
3	Hardware interfaces.....	226
4	Wiring.....	232
5	Process data definition.....	233
6	Configuration parameter definitions.....	235
A	Dimension drawing.....	237
CT-121F	16 channels digital input/24VDC/ PNP.....	238
1	Module features.....	238
2	Technical parameters.....	239
3	Hardware interfaces.....	241
4	Wiring.....	247
5	Process data definition.....	248

6 Configuration parameter definitions.....	251
A Dimension drawing.....	253
CT-1228 8 channels digital input/24VDC/NPN.....	254
1 Module features.....	254
2 Technical parameters.....	255
3 Hardware interfaces.....	257
4 Wiring.....	263
5 Process data definition.....	264
6 Configuration parameter definitions.....	266
A Dimension drawing.....	268
CT-122F 16 channels digital input/24VDC/NPN.....	269
1 Module features.....	269
2 Technical parameters.....	270
3 Hardware interfaces.....	272
4 Wiring.....	278
5 Process data definition.....	279
6 Configuration parameter definitions.....	282
A Dimension drawing.....	284
CT-124H 32 channels digital input/24VDC/PNP or NPN.....	285
1 Module features.....	285
1 Technical parameters.....	286
3 Hardware interfaces.....	288
4 Wiring.....	293
5 Process data definition.....	294
6 Configuration parameter definitions.....	298
A Dimension drawing.....	301
CT-124D 32-channel digital input/24VDC/Sink or Source.....	302
1 Module features.....	302

2	Technical Parameters.....	303
3	Hardware interface.....	305
4	Wiring.....	311
5	Process Data Definition.....	312
6	Configuration Parameter Definition.....	315
A	Dimensional drawing.....	318
CT-125F 16 channels digital input/24VDC/ PNP.....		319
1	Module features.....	319
2	Technical parameters.....	320
3	Hardware interfaces.....	322
4	Wiring.....	329
6	Configuration parameter definitions.....	333
A	Dimension drawing.....	335
CT-126F 16 channels digital input/24VDC/NPN.....		336
1	Module features.....	336
2	Technical parameters.....	337
3	Hardware interfaces.....	339
4	Wiring.....	346
6	Configuration parameter definitions.....	350
A	Dimension drawing.....	352
CT-1314 4 channels digital input/220VAC.....		353
1	Module features.....	353
2	Technical parameters.....	354
3	Hardware interface.....	356
4	Wiring.....	362
5	Process Data Definition.....	363
6	Configuration parameter definitions.....	365
A	Dimensional drawing.....	367

CT-2224 4 channels digital output/24VDC/ PNP.....	368
1 Module features.....	368
2 Technical Parameters.....	369
3 Hardware Interface.....	371
4 Wiring.....	377
5 Process data definition.....	378
6 Configuration parameters definition.....	378
A Dimension drawing.....	379
CT-2218 8 channels digital output/24VDC/NPN.....	380
1 Module features.....	380
2 Technical Parameters.....	381
3 Hardware Interface.....	383
4 Wiring.....	389
5 Process data definition.....	390
6 Configuration parameters definition.....	391
A Dimension drawing.....	393
CT-2228 8 channels digital output/24VDC/ PNP.....	394
1 Module features.....	394
2 Technical Parameters.....	395
3 Hardware Interface.....	397
4 Wiring.....	403
5 Process data definition.....	404
6 Configuration parameters definition.....	404
A Dimension drawing.....	405
CT-222F 16 channels digital output/24VDC/PNP.....	406
1 Module features.....	406
2 Technical parameters.....	407
3 Hardware interfaces.....	409

4 Wiring.....	415
5 Process data definition.....	416
6 Configuration parameter definitions.....	416
A Dimension drawing.....	418
CT-222F-NP 16 channels digital output/24VDC/PNP.....	419
1 Module features.....	419
2 Technical parameters.....	420
3 Hardware interfaces.....	422
4 Wiring.....	428
5 Process data definition.....	429
6 Configuration parameter definitions.....	429
A Dimension drawing.....	431
CT-222H 32 channels digital output/24VDC/PNP.....	432
1 Module features.....	432
2 Technical parameters.....	433
3 Hardware interfaces.....	435
4 Wiring.....	440
5 Process data definition.....	441
6 Configuration parameter definitions.....	441
A Dimension drawing.....	443
CT-222D 32 channels digital output/24VDC/Sink.....	444
1 Module features.....	444
2 Technical Parameters.....	445
3 Hardware interface.....	447
4 Wiring.....	453
5 Process Data Definition.....	454
6 Configuration Parameter Definition.....	454
A Dimensional drawing.....	456

CT-221F 16 channels digital output/24VDC/NPN.....	457
1 Module features.....	457
2 Technical parameters.....	458
3 Hardware interfaces.....	460
4 Wiring.....	466
5 Process data definition.....	467
6 Configuration parameter definitions.....	467
A Dimension drawing.....	469
CT-221H 32 channels digital output/24VDC/NPN.....	470
1 Module features.....	470
2 Technical parameters.....	471
3 Hardware interfaces.....	473
4 Wiring.....	478
5 Process data definition.....	479
6 Configuration parameter definitions.....	479
A Dimension drawing.....	481
CT-221D 32 channels digital output/24VDC/NPN.....	482
1 Module features.....	482
2 Technical parameters.....	483
3 Hardware interfaces.....	485
4 Wiring.....	491
5 Process data definition.....	492
6 Configuration parameter definitions.....	492
A Dimension drawing.....	494
CT-2244 4 channels digital output/24VDC/ PNP or NPN.....	496
1 Module features.....	496
2 Technical Parameters.....	497
3 Hardware Interface.....	499

4 Wiring.....	505
5 Process data definition.....	506
6 Configuration parameters.....	508
A Dimension drawing.....	510
CT-225F 16 channels digital output/24VDC/NPN.....	511
1 Module features.....	511
2 Technical parameters.....	512
3 Hardware interfaces.....	514
4 Wiring.....	521
6 Configuration parameter definitions.....	523
A Dimension drawing.....	524
CT-226F 16 channels digital output/24VDC/PNP.....	525
1 Module features.....	525
2 Technical parameters.....	526
3 Hardware interfaces.....	528
4 Wiring.....	535
6 Configuration parameter definitions.....	537
A Dimension drawing.....	538
CT-2718 8 channels relay output 1A/30VDC/30W.....	539
1 Module features.....	539
2 Technical Parameters.....	540
3 Hardware Interface.....	542
4 Wiring.....	548
5 Process data definition.....	549
6 Configuration parameters definition.....	549
A Dimension drawing.....	550
CT-2738 8 channels relay output 1A/30VDC/30W.....	551
1 Module features.....	551

2	Technical Parameters.....	552
3	Hardware Interface.....	554
4	Wiring.....	560
5	Process data definition.....	561
6	Configuration parameters definition.....	561
A	Dimension drawing.....	562
CT-2754	4 channels relay output, 3A/30VDC/90W.....	563
1	Module features.....	563
2	Technical Parameters.....	564
3	Hardware Interface.....	566
4	Wiring.....	572
5	Process data definition.....	573
6	Configuration parameters definition.....	573
A	Dimension drawing.....	574
CT-2794	4 channel relay output, 2A/250VAC/500VA.....	575
1	Module features.....	575
2	Technical Parameters.....	576
5	Process data definition.....	585
6	Configuration parameters definition.....	585
CT-3134	4 channels Voltage Input 0~5/0~10/±5/±10VDC, 15 bits /16 bits.....	587
1	Module features.....	587
2	Technical Parameters.....	588
3	Hardware Interface.....	590
4	Wiring.....	596
5	Process data definition.....	598
6	Configuration parameters definition.....	600
A	Dimension drawing.....	602

CT-3158: 8 channels voltage Input 0~5V/0~10/±5/±10VDC, 12Bits...	603
1 Module features.....	603
2 Technical Parameters.....	604
3 Hardware Interface.....	606
4 Wiring.....	612
5 Process data definition.....	614
6 Configuration parameters definition.....	615
A Dimension drawing.....	617
CT-3168 8 channels voltage Input 0~5/0~10/±5/±10VDC, 15Bit/16 Bit	
.....	618
1 Module features.....	618
2 Technical Parameters.....	619
3 Hardware Interface.....	621
4 Wiring.....	627
5 Process data definition.....	629
6 Configuration parameters definition.....	631
A Dimension drawing.....	633
CT-3234 4 channels analog input /0&4-20mA/15-bit single-ended.....	634
1 Module features.....	634
2 Technical parameters.....	635
3 Hardware interface.....	637
4 Wiring.....	643
5 Process data definition.....	645
6 Configuration parameter definition.....	646
A Dimension drawing.....	648
CT-3238: 8 channels analog input /0&4-20mA/15-bit single-terminal	649
1 Module features.....	649
2 Technical parameters.....	650

3 Hardware interfaces.....	652
4 Wiring.....	658
5 Process data definition.....	660
6 Configuration parameter definition.....	662
A Dimension drawing.....	664
CT-3258 8 channels analog input /0~20mA OR -20~0mA OR \pm 20mA /12bit Single-ended bipolar.....	665
1 Module features.....	665
2 Technical parameters.....	666
3 Hardware interfaces.....	668
4 Wiring.....	674
5 Process data definition.....	676
6 Configuration parameter definition.....	677
A Dimension drawing.....	678
CT-3268 8 channels analog input /0~20mA OR -20~0mA OR \pm 20mA /15bit Single-ended bipolar.....	679
1 Module features.....	679
2 Technical parameters.....	680
3 Hardware interfaces.....	682
4 Wiring.....	688
5 Process data definition.....	690
6 Configuration parameter definition.....	693
A Dimension drawing.....	695
CT-3274 4 channels analog input /0&4-20mA/ \pm 20 mA 16 bits differential input.....	696
1 Module features.....	696
2 Technical parameters.....	697
3 Hardware interface.....	699

4 Wiring.....	705
5 Process data definition.....	707
6 Configuration parameter definition.....	709
A Dimension drawing.....	711
CT-3713 3 channels RTD-PT100 temperature acquisition module.....	712
1 Module features.....	712
2 Technical Parameters.....	713
3 Hardware Interface.....	715
4 Wiring.....	721
5 Process data definition.....	722
6 Configuration parameters definition.....	723
A Dimension drawing.....	724
CT-3723 3 channels RTD-PT1000 temperature acquisition module.....	725
1 Module features.....	725
2 Technical Parameters.....	726
3 Hardware Interface.....	728
4 Wiring.....	734
5 Process data definition.....	735
6 Configuration parameters definition.....	736
A Dimension drawing.....	738
CT-3716 6-channel RTD-PT100 Temperature Acquisition Module.....	739
1 Module features.....	739
2 Technical Parameters.....	740
3 Hardware interface.....	742
4 Wiring.....	748
5 Process data definition.....	749
6 Configuration parameter definition.....	751
A Dimensional drawing.....	753

CT-3726 6-channel RTD-PT1000 Temperature Acquisition Module.....	754
1 Module features.....	754
2 Technical Parameters.....	755
3 Hardware interface.....	757
4 Wiring.....	763
5 Process data definition.....	764
6 Configuration parameter definition.....	765
A Dimensional drawing.....	767
CT-3734 4 channels RTD-PT100 temperature acquisition module.....	768
1 Module features.....	768
2 Technical Parameters.....	769
3 Hardware Interface.....	771
4 Wiring.....	777
5 Process data definition.....	778
6 Configuration parameters definition.....	779
A Dimension drawing.....	781
CT-3744 4-channel RTD-PT1000 Temperature Acquisition Module.....	782
1 Module Features.....	782
2 Technical Parameters.....	783
3 Hardware Interface.....	785
4 Wiring.....	791
5 Process data definition.....	792
6 Configuration parameters definition.....	793
A Dimension drawing.....	795
CT-3804 4-channel TC thermocouple temperature acquisition module.	796
1 Module features.....	796
2 Technical Parameters.....	797
3 Hardware Interface.....	799

4 Wiring.....	805
5 Process data definition.....	807
6 Configuration parameters definition.....	811
A Dimension drawing.....	815
CT-3808 8 channels Analog Input, Thermocouple (TC- J ,K , E , T , S, R , B , N) types.....	816
1 Module features.....	816
2 Technical parameters.....	817
3 Hardware Interface.....	819
4 Wiring.....	825
5 Process data definition.....	827
6 Configuration parameters definition.....	833
A Dimension drawing.....	837
CT-3844 4 channels Analog Input, Thermocouple (TC-J/K/E/T/S/R/B/N) Types (filter adjustable).....	838
1 Module features.....	838
2 Technical Parameters.....	839
3 Hardware Interface.....	841
4 Wiring.....	847
5 Process data definition.....	849
6 Configuration parameters definition.....	855
A Dimension drawing.....	857
CT-3848 8 channels Analog Input Thermocouple (TC-J/K/E/T/S/R/B/N) types (filter adjustable).....	858
1 Module features.....	858
2 Technical Parameters.....	859
3 Hardware Interface.....	861
4 Wiring.....	867

5	Process data definition.....	869
6	Configuration parameters definition.....	875
A	Dimension drawing.....	878
CT-4154	4 channels Voltage Output 0~5VDC/0~10VDC/±5VDC/±10VDC, 16 bits.....	879
1	Module features.....	879
2	Technical Parameters.....	880
3	Hardware Interface.....	882
4	Wiring.....	888
5	Process data definition.....	890
6	Configuration parameters definition.....	893
A	Dimension drawing.....	894
CT-4158	8 channels Voltage Output 0~5VDC/0~10VDC/±5VDC/±10VDC, 16bits.....	895
1	Module features.....	895
2	Technical Parameters.....	896
3	Hardware Interface.....	898
4	Wiring.....	904
5	Process data definition.....	906
6	Configuration parameters definition.....	909
A	Dimension drawing.....	911
CT-4234	4 channels analog output /0&4-20mA/16-bit single-terminal.....	912
1	Module features.....	912
2	Technical parameters.....	913
3	Hardware interfaces.....	915
4	Wiring.....	921
5	Progress data definition.....	923
6	Configuration parameter definition.....	926

A Dimension drawing.....	928
CT-4238 8 channel analog output /0&4-20mA/16 bit.....	929
1 Module features.....	929
2 Technical parameters.....	930
3 Hardware interfaces.....	932
4 Wiring.....	938
5 Process data definition.....	940
6 Configuration parameter definition.....	943
A Dimension drawing.....	945
CT-5000 Virtual module.....	946
1 Module feature.....	946
2 Technical parameters.....	946
3 Hardware Interfaces.....	948
4 Wiring.....	949
5 Process data definition.....	949
6 Configuration parameter definition.....	950
A Dimension drawing.....	951
CT-5102 2-channels encoder input /5VDC.....	952
1 Module features.....	952
2 Technical parameters.....	953
3 Hardware interfaces.....	955
4 Wiring.....	962
5 Process data definition.....	963
6 Configuration parameters definition.....	966
A Dimension drawing.....	970
CT-5112 2-channels encoder input/24VDC.....	971
1 Module features.....	971
2 Technical parameters.....	972

3	Hardware interfaces.....	974
4	Wiring.....	981
5	Process data definition.....	982
6	Configuration parameters definition.....	985
A	Dimension drawing.....	989
7	CT-5112 Submodule configuration parameter description.....	990
8	CT-5112 Submodule process data description.....	999
9	CT-5112 Sub-module Communication Example.....	1002
CT-5122	2-channels encoder/SSI input.....	1012
1	Module features.....	1012
2	Technical parameters.....	1013
3	Hardware interfaces.....	1015
4	Wiring.....	1022
5	Process data definition.....	1023
6	Configuration parameters definition.....	1025
A	Dimension drawing.....	1028
CT-5142	2-channels encoder /differential input.....	1029
1	Module features.....	1029
2	Technical parameters.....	1030
3	Hardware interfaces.....	1032
4	Wiring.....	1039
5	Process data definition.....	1040
6	Configuration parameters definition.....	1043
A	Dimension drawing.....	1047
CT-5212	8-channel digital input &2-channel digital output &2-channel PWM output.....	1048
1	Module features.....	1048
2	Technical parameters.....	1049

3	Hardware interfaces.....	1051
4	Wiring.....	1057
5	Process data definition.....	1058
6	Configuration parameter definition.....	1063
CT-5224	4-channel digital input/4-channel digital output/4-channel PWM output.....	1069
1	Module features.....	1069
2	Technical parameters.....	1070
3	Hardware interfaces.....	1072
4	Wiring.....	1078
5	Process data definition.....	1079
6	Configuration parameter definitions.....	1082
A	Dimension drawing.....	1086
CT-5321	Modbus Serial Port Module.....	1087
1	Module Description.....	1087
2	Technical Parameters.....	1088
3	Hardware Interface.....	1090
4	Wiring.....	1096
5	Process data definition.....	1097
6	Configuration parameters definition.....	1098
A	Dimension drawing.....	1108
CT-5331	CANopen Master module.....	1109
1	Module Description.....	1109
2	Technical Parameters.....	1110
3	Hardware Interface.....	1112
4	Wiring.....	1118
5	Process data definition.....	1120
6	Configuration parameters definition.....	1121

A Dimension drawing.....	1139
CT-5341 Profibus DP Master module.....	1140
1 Module Description.....	1140
2 Technical Parameters.....	1141
3 Hardware interface.....	1143
4 Wiring.....	1149
5 Process Data Definition.....	1152
6 Configuration Parameters Definition.....	1158
A Dimensional drawing.....	1159
CT-5711 Bus extended master module.....	1160
1 Module Description.....	1160
2 Technical Parameters.....	1160
3 Hardware Interface.....	1162
4 Bus extension topology diagram.....	1165
5 Wiring.....	1166
A Dimension drawing.....	1168
CT-5721 Bus extended slave module.....	1169
1 Module Description.....	1169
2 Technical Parameters.....	1169
3 Hardware Interface.....	1171
4 Topological graph.....	1174
5 Wiring.....	1175
A Dimension drawing.....	1177
CT-5800 Terminal module.....	1178
1 Module Description.....	1178
2 Technical Parameters.....	1178
3 Hardware Interface.....	1180
A Dimension drawing.....	1183

CT-5801 Terminal module (Required)	1184
1 Module Description.....	1184
2 Technical Parameters.....	1184
3 Hardware Interface.....	1185
A Dimension drawing.....	1187
CT-5802 Terminal module (Required)	1188
1 Module Description.....	1188
2 Technical Parameters.....	1188
3 Hardware Interface.....	1188
A Dimension drawing.....	1189
CT-623F 8-channels DI /24VDC/ source or sink type & 8-channels DO /24VDC/ source type.....	1190
1 Module features.....	1190
2 Technical parameters.....	1191
3 Hardware interfaces.....	1193
4 Wiring.....	1201
5 Process data definition.....	1202
6 Configuration parameter definition.....	1204
A Dimension drawing.....	1207
CT-7100 Field Power Expansion Module 8A (no configuration required)	1208
1 Module features.....	1208
2 Technical parameters.....	1208
3 Hardware interfaces.....	1210
4 Wiring.....	1216
5 Process data definition.....	1218
6 configuration parameters definition.....	1218
A Dimension drawing.....	1219

CT-7220 Power Supply Extension Module 5V/2A (requires no configuration)	1220
1 Module features.....	1220
2 Technical Parameters.....	1221
3 Hardware Interface.....	1223
4 Wiring.....	1229
5 Process data definition.....	1231
6 Configuration parameters definition.....	1231
A Dimension drawing.....	1232
CT-7221 Power Supply Extension Module 5V/2A.....	1233
1 Module features.....	1233
2 Technical Parameters.....	1234
3 Hardware Interface.....	1236
4 Wiring.....	1242
5 Process data definition.....	1244
6 Configuration parameters definition.....	1244
A Dimension drawing.....	1245
CT-730F 18 channels field power distribution module (0VDC)	1246
1 Module features.....	1246
2 Technical Parameters.....	1247
3 Hardware Interface.....	1248
4 Wiring.....	1252
5 Process data definition.....	1253
6 Configuration parameters definition.....	1253
A Dimension drawing.....	1254
CT-731F 18 channels field power distribution module (24Vdc)	1255
1 Module features.....	1255
2 Technical Parameters.....	1256

3 Hardware Interface.....	1257
4 Wiring.....	1261
5 Process data definition.....	1262
6 Configuration parameters definition.....	1262
A Dimension drawing.....	1263
CT-732F 18 channels field power distribution module (PE)	1264
1 Module features.....	1264
2 Technical Parameters.....	1265
3 Hardware Interface.....	1266
4 Wiring.....	1270
5 Process data definition.....	1271
6 Configuration parameters definition.....	1271
A Dimension drawing.....	1272
CT-7339 18 channels field power distribution module (24VDC/0VDC)	1273
1 Module features.....	1273
2 Technical Parameters.....	1274
3 Hardware Interface.....	1275
4 Wiring.....	1279
5 Process data definition.....	1280
6 Configuration parameters definition.....	1280
A Dimension drawing.....	1281
CT-7346 18 channels field power distribution module (24VDC/0VDC/PE)	1282
1 Module features.....	1282
2 Technical Parameters.....	1283
3 Hardware Interface.....	1284
4 Wiring.....	1288

5 Process data definition.....	1289
6 Configuration parameters definition.....	1289
A Dimension drawing.....	1290
4 IO-Config configuration software.....	1291
1 Software introduction.....	1291
2 Offline configurations.....	1292
3 Online configurations.....	1299
4 Update device library files.....	1307
5 Device firmware upgrades.....	1309

Legal Statement

The ODOT Automation brand and any trademarks of Sichuan ODOT Automation System Co., Ltd. (hereinafter referred to as ODOT Automation) and its affiliates mentioned in this guide are the property of Sichuan ODOT Automation System Co., Ltd. or its subsidiaries. All other brands mentioned in this document are the trademarks of their respective owners. This guide and its contents are protected by applicable copyright laws and are provided for informational purposes only. No part of this guide may be reproduced or transmitted for any purpose, in any form or by any means (electronic, mechanical, photocopying, recording or otherwise) without the prior written permission of Sichuan ODOT Automation System Co., Ltd.

Sichuan ODOT Automation System Co., Ltd. grants no right or license to commercial use of this guide or its contents, other than a non-exclusive personal license to consult on an "AS IS" basis.

The products and equipment of Sichuan ODOT Automation System Co., Ltd. shall be installed, operated, serviced and maintained by qualified personnel.

As standards, specifications and designs change from time to time, the information contained in this guide is subject to change without notice.

To the extent permitted by applicable laws, Sichuan ODOT Automation System Co., Ltd. and its affiliates will not assume any responsibility or liability for any errors or omissions in the information content of this document, or for the consequences caused or arising from the use of the information contained herein.

As part of a responsible, inclusive business, we will update content that includes non-inclusive terms. However, until we complete the update process, our content may still contain standardized industry terminology that our customers deem inappropriate.

Copyright © 2019 Sichuan ODOT Automation System Co., Ltd. all rights reserved

Security Information

Important Information

Before attempting to install, operate, service, or maintain the equipment, please read the following instructions carefully and look to familiarize yourself with the equipment. Specific information described below may appear elsewhere in the text or on the device to alert the user to potential hazards, or to call attention to information that clarifies or simplifies a procedure. If the equipment is used in a manner not specified by the manufacturer, the protection provided by the equipment may be impaired.



The addition of this symbol to a DANGER or WARNING label indicates the presence of an electric shock hazard which, if instructions are not followed, will result in personal injury.



This is a symbol to remind you to be safe. Remind users of the possible danger of personal injury. Please follow all safety precautions with this symbol to avoid possible personal injury or even death.

DANGER

DANGER INDICATES A HAZARDOUS SITUATION WHICH, IF NOT AVOIDED, WILL RESULT IN SERIOUS INJURY OR DEATH.

WARNING

WARNING INDICATES A HAZARDOUS SITUATION WHICH, IF NOT AVOIDED, COULD RESULT IN SERIOUS INJURY OR DEATH.

CAUTION

CAUTION INDICATES A HAZARDOUS SITUATION WHICH, IF NOT AVOIDED, COULD RESULT IN MINOR OR MODERATE INJURY OR DEATH.

NOTICE

NOTICE INDICATES A HAZARD NOT RELATED TO PERSONAL INJURY.

Attention

Installation, operation, repair and maintenance of electrical equipment is restricted to qualified personnel only. Sichuan ODOT Automation System Co., Ltd. shall not be responsible for any consequences arising from the use of this user manual.

Qualified personnel are those who have the skills and knowledge related to the manufacturing and operation of electrical equipment and its installation, and who have been trained in safety to be able to detect and avoid related hazards.

Personnel Qualification

Only properly trained personnel who are familiar with and understand the contents of this manual and all other related product documentation are authorized to use this product. Qualified personnel must be able to detect possible hazards arising from setting parameters and modifying parameter values, usually from mechanical, electrical or electronic equipment. Qualified personnel must be familiar with the various standards, rules and regulations aimed at preventing industrial accidents and must comply with them when designing and building systems.

Expected Usage

The products described or referred to in this document, together with their software, accessories and options, are expansion modules designed for industrial use and should be used in accordance with the relevant instructions, guide, examples and safety instructions in this document and other supporting documents.

This product must be used in compliance with all applicable safety laws and regulations, specified requirements and technical parameters. Due to planned application, you must perform a risk assessment before using this product. Appropriate safety-related measures must be taken based on the results of the evaluation.

Since this product should be used as an integral part of the entire machine or process, the safety of personnel must be ensured through the design of the entire system.

This product must be used with the specified cables and accessories. Please use only original spare parts and original replacement parts.

Any use other than that expressly permitted is prohibited as unintended hazards may result.

Network Safety Tips

- A. Use controllers and devices only in protected environments to minimize network exposure and ensure inaccessibility from the outside.
- B. Use a firewall to protect the control system network and separate it from other networks.
- C. If remote access is required, please use a VPN (Virtual Private Network) tunnel.
- D. Restrict access to development and control systems by physical means, operating system capabilities, etc.
- E. Protect development and control systems with the latest virus detection solutions.

About this manual

Document Scope

This guide introduces the hardware implementation of C3351 programmable controller and CODESYS programming cases. It provides descriptions, characteristics, wiring diagrams and installation details for Modbus TCP and Modbus COM network adapters and Digital Input, Digital Output, Analog Input, Analog Output, and special modules.

Validity Statement

In accordance with our policy of continuous improvement, we will continue to revise the content of this manual to make it clearer and more accurate.

Sichuan ODOT Automation System Co., Ltd. reserves the right of final interpretation of this manual.

Product Information



HAZARD OF ELECTRIC SHOCK, EXPLOSION, OR ARC FLASH

Disconnect power from all equipment (including connected equipment) before removing any covers, or installing or removing any accessories, hardware, cables, or wires, unless otherwise specified in the corresponding hardware guide for this equipment.

As directed, at the appropriate place and time, it is important to always use a properly rated voltage sensing devices to detect if the power is off.

Replace and secure all covers, accessories, hardware, cables and wires, and verify proper ground connection before powering on the device.

When operating this equipment and related products, the specified voltage must be used.

Failure to follow instructions specified by the manufacturer may result in serious consequences such as death, personal injury, or damage to equipment since the protection provided by the equipment may be impaired.

DANGER

POSSIBLE EXPLOSION HAZARD

Do not connect or disconnect equipment unless it is unplugged or the location is known to be non-hazardous.

Use the USB port (if equipped) only if the work area is known to be non-hazardous.

Failure to follow instructions specified by the manufacturer may result in serious consequences such as death, personal injury, or damage to equipment since the protection provided by the equipment may be impaired.

WARNING

OUT OF CONTROL

The designer of any control scheme must account for the possible failure of the control path and provide a means for certain critical control functions could be restored to a safe state during and after path failure. These critical control functions include emergency stop, over-travel stop, power-off restart, and similar safety measures.

For critical control functions, separate or redundant control paths must be provided.

System control paths may include communication links. Consideration must be given to the implications of unforeseen transmission delays or link failures.

Comply with all accident prevention regulations and local safety guidelines.

To guarantee proper operation, each implementation of the device must be fully tested individually before being placed into service.

Failure to follow instructions specified by the manufacturer may result in serious consequences such as death, personal injury, or damage to equipment since the protection provided by the equipment may be impaired.

AVERTISSEMENT

PERTE DE CONTROLE

Le concepteur de tout programme de contrôle doit tenir compte de l'éventuelle défaillance de la trajectoire de commande et prévoir un moyen pour certaines fonctions de contrôle critiques de revenir à un état sûr en cas de défaillance de la trajectoire et après. Ces fonctions de contrôle clés comprennent l'arrêt d'urgence, l'arrêt hors portée, le redémarrage en cas de panne de courant et des mesures de sécurité similaires.

Pour les fonctions de contrôle critiques, des chemins de contrôle distincts ou redondants doivent être fournis.

Le chemin de contrôle du système peut inclure des liens de communication. Les problèmes implicites de retard imprévu de transmission ou de défaillance de liaison doivent être pris en considération.

Respectez toutes les règles de prévention des accidents et les directives de sécurité locales.

Afin de garantir un fonctionnement correct, il est essentiel que chaque exécution de l'équipement soit testée individuellement et en détail avant sa mise en service.

Le fait de ne pas suivre les instructions peut entraîner une défaillance de la protection fournie par l'équipement, ce qui peut entraîner des conséquences graves, comme des blessures ou des dommages à l'équipement.

WARNING

UNINTENDED EQUIPMENT OPERATION

Only use software approved by Sichuan ODOT Automation System Co., Ltd. for use with this equipment.

Please update the application after every change to the physical hardware configuration.

Failure to follow instructions specified by the manufacturer may result in serious consequences such as death, personal injury, or damage to equipment since the protection provided by the equipment may be impaired.

 AVERTISSEMENT

FONCTIONNEMENT INATTENDU DE L'EQUIPEMENT

Utilisez uniquement un logiciel approuvé par Sichuan ODOT Automation System Co., Ltd. pour une utilisation avec cet équipement.

Veillez mettre à jour l'application après chaque modification de la configuration matérielle physique.

Le fait de ne pas suivre les instructions peut entraîner une défaillance de la protection fournie par l'équipement, ce qui peut entraîner des conséquences graves, comme des blessures ou des dommages à l'équipement.

 WARNING

UNINTENDED EQUIPMENT OPERATION

The risk assessment should include the possibility of a communication failure between the logic controller and any I/O expansion modules.

If the I/O module output signal "maintain current value" does not meet your application requirements when the I/O expansion Bus error occurs, other solutions should be used to ensure that the application can cope with Bus error events.

Failure to follow instructions specified by the manufacturer may result in serious consequences such as death, personal injury, or damage to equipment since the protection provided by the equipment may be impaired.

 AVERTISSEMENT

FONCTIONNEMENT INATTENDU DE L'EQUIPEMENT

L'évaluation des risques devrait inclure la possibilité d'une panne de communication entre le contrôleur logique et tout module d'extension d'E/S.

Si le signal de sortie du module d'E/S «maintenir la valeur actuelle» ne répond pas aux exigences de votre application lorsque l'erreur du Bus d'extension d'E/S se produit, d'autres solutions doivent être utilisées pour s'assurer que l'application peut faire face aux événements d'erreur de Bus.

Le fait de ne pas suivre les instructions peut entraîner une défaillance de la protection fournie par l'équipement, ce qui peut entraîner des conséquences graves, comme des blessures ou des dommages à l'équipement.

1 Product Overview

Remote IO system consists of network adapter module and extended IO module. The network adapter module controls fieldbus communication and it realizes communication link with host station controller or host computer software.

The extended IO module controls the connection with the input and output sensors in the field. At first the Input IO module collects the field signals and sends it to the network adapter through the internal bus. Secondly the controller reads and processing data from the adapter through the field bus, and it writes the output data into the network adapter, then the network adapter could write the output data into the output IO module via the internal bus, so the field equipment control could be realized.

According to the communication interface of the controller system, the network adapter could select the corresponding bus module and mainstream industrial communication protocols including Modbus, Profibus-DP, Profinet, EtherCAT, EtherNet/IP, CANsopen, CC-Link, PowerLink, etc. And there are 6 categories of extended IO modules such as: digital input module, digital output module, analog input module, analog output module, special module, hybrid IO module, etc.

The network adapter and the extended IO module could be freely combined according to the field requirements, and it could achieve lower cost with the Remote IO module when the project requires more data points.

1.1 Module Feature

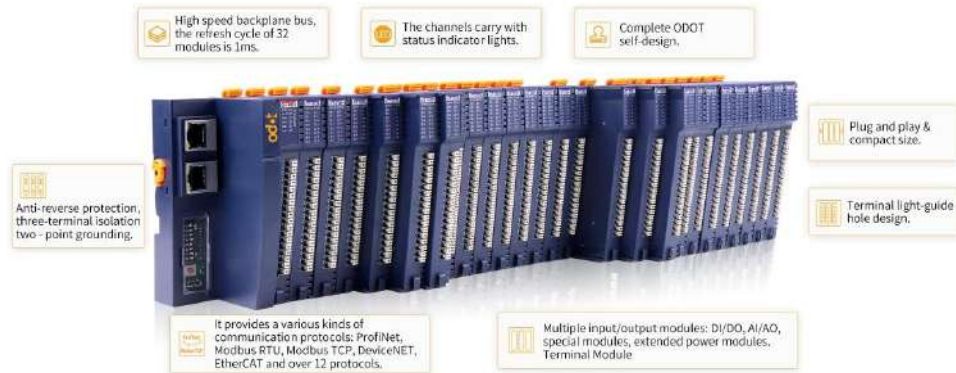

1.2 Module Layout

The ODOT-C series is a remote I/O module. The adapter module lies on the far left, and on the right are extended I/O modules.

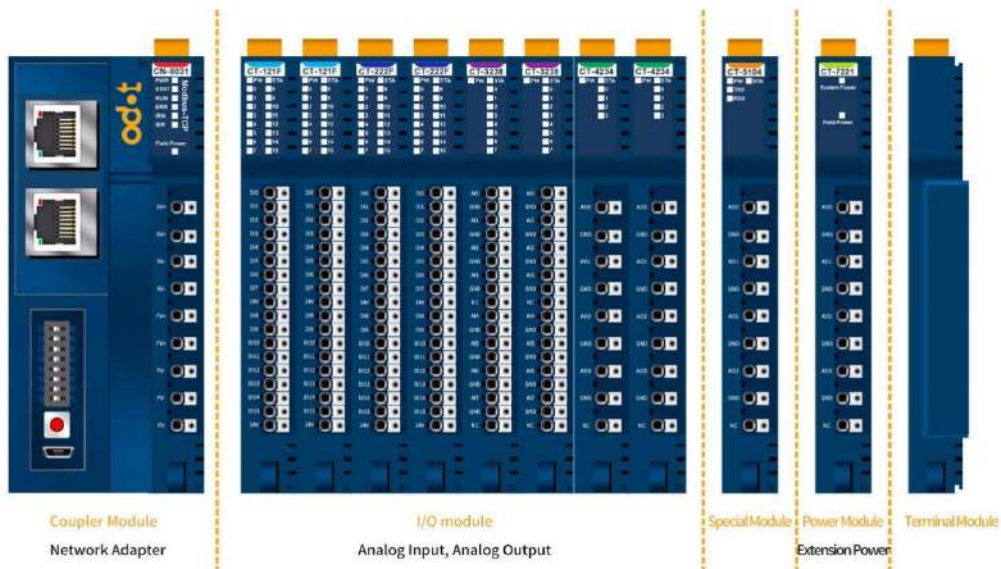

1.3 LED Indicators

The user can easily check the power state of adapter and I/O module, I/O module operating state, and the number of I/O channels though LED state. And the detailed indicator state should refer to the related adapter or IO modules.

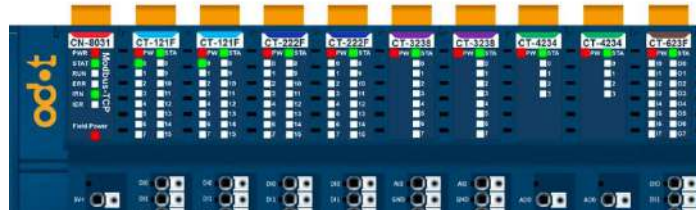

⚠ WARNING

OUT OF CONTROL

For details about the indicator status of the network adapter module, see related chapters.
 For details about the indicator status of the I/O module, see related chapters.
 Different indicator states indicate that the module is in different working states.
 The indicator status is incorrect, and the module is not working properly.

Failure to follow instructions specified by the manufacturer may result in serious consequences such as death, personal injury, or damage to equipment since the protection provided by the equipment may be impaired.

⚠ AVERTISSEMENT

PERTE DE CONTRÔL

L'état de l'indicateur du module adaptateur réseau se réfère aux notes du chapitre correspondant.
 L'état de l'indicateur du module E/S se réfère aux notes du chapitre correspondant.
 Etat différent de l'indicateur pour montrer que le module est dans différentes conditions de travail.
 L'état de l'indicateur n'est pas correct et le module fonctionne incorrectement.

Le fait de ne pas suivre les instructions peut entraîner une défaillance de la protection fournie par l'équipement, ce qui peut entraîner des conséquences graves, comme des blessures ou des dommages à l'équipement.

1.4 Grounding

There is one metal Spring sheet on the back of the module, which is used for effective grounding with the guide rail. The metal spring sheet and the adapter PE (protective earthing) are connected internally.

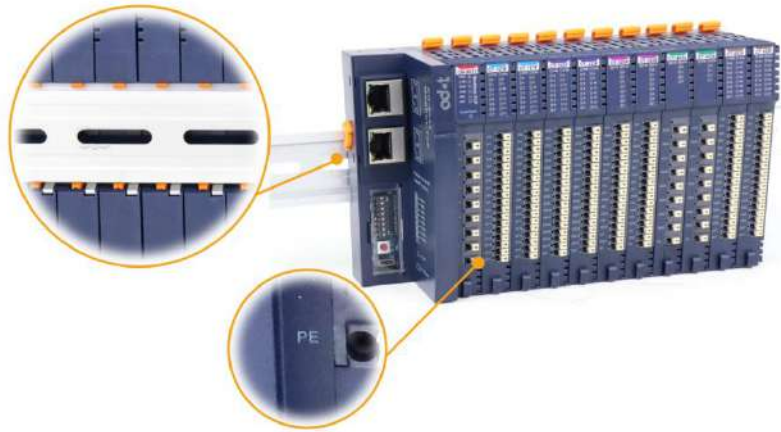

1.4.1 Functional grounding on the DIN rail

The system DIN rail is the common functional grounding plane and must always be mounted on a conductive backplane.

⚠ WARNING
<p>UNINTENDED EQUIPMENT OPERATION</p> <p>·Connect the DIN rail to the functional grounding of the installed equipment.</p> <p>Failure to follow instructions specified by the manufacturer may result in serious consequences such as death, personal injury, or damage to equipment since the protection provided by the equipment may be impaired.</p>
⚠ AVERTISSEMENT
<p>FONCTIONNEMENT INATTENDU DE L'EQUIPEMENT</p> <p>·Connectez le rail DIN à la mise à la terre fonctionnelle de l'équipement installé.</p> <p>Le fait de ne pas suivre les instructions peut entraîner une défaillance de la protection fournie par l'équipement, ce qui peut entraîner des conséquences graves, comme des blessures ou des dommages à l'équipement.</p>

1.4.2 System Grounding

Due to the influence of electromagnetic interference, cables carrying fast I/O, analog I/O and fieldbus communication signals must be shielded cables.

WARNING

UNINTENDED EQUIPMENT OPERATION

- Please use shielded cables for all fast I/O, analog I/O, and communication signals.
- Please use shielded cables for single point connection for all fast I/O, analog I/O and communication signals. [1]
- Arrange power cables separately from communication and I/O cables.

Failure to follow instructions specified by the manufacturer may result in serious consequences such as death, personal injury, or damage to equipment since the protection provided by the equipment may be impaired.

[1] Multi-point grounding is permitted (and in some cases unavoidable) if it is connected to the equipotential grounding plane to avoid damage to the cable shield in the event of a power system short-circuit current. When using shielded cables, the following wiring rules need to be followed:

For the protective earthing (PE), metal pipes or wires can be used as part of the shield length, the premise is it should provide the entire earthing connection continuously without interruption. For functional grounding, shielding is used to reduce electromagnetic interference and the shielding must be continuous throughout the cable without interruption. If for both functional and protective purposes (This is usually the case for communication cables), the shielding of the cable must be continuous without interruption.

Cables carrying different types of signals or power should be separated whenever possible.

AVERTISSEMENT

FONCTIONNEMENT INATTENDU DE L'ÉQUIPEMENT

Utilisez des câbles blindés pour toutes les entrées/sorties rapides, entrées/sorties analogiques et signaux de communication.

Mise à la terre en point unique avec câble blindé pour toutes les entrées/sorties rapides, entrées/sorties analogiques et signaux de communication. [1]

Câblez les câbles d'alimentation séparément des câbles de communication et des câbles d'E/S.

Le fait de ne pas suivre les instructions peut entraîner une défaillance de la protection fournie par l'équipement, ce qui peut entraîner des conséquences graves, comme des blessures ou des dommages à l'équipement.

La mise à la terre multipoint est permise si elle est connectée à la surface de raccordement équipotentielle afin d'éviter d'endommager le blindage du câble en cas de court-circuit du système d'alimentation (ce qui est inévitable dans certains cas). Lorsque vous utilisez un câble blindé, vous devez suivre les règles de câblage suivantes:

Condensation de la masse de protection pour (PE), la fabrication d'ouvrages en métaux de bloquer la longueur du tronçon ou peuvent servir à condition que l'ensemble de la liaison entre la masse cohérente sans interruption pour fonctionnelle au sol, destinés à réduire les perturbations électromagnétiques, le blindage et entiers blindage du câble de la cohérence sans interruption, si parallèlement à des fins de protection fonctionnelle et câbles normalement c'est le cas), Le blindage des câbles doit être continu sans interruption. En même temps, les câbles qui transmettent différents types de signaux ou d'alimentation doivent être séparés.

1.4.3 Protective Earthing on the backplane (PE)

The protective earthing (PE) is connected to the conductive backplane by a heavy-duty conductor (usually a braided copper cable with the largest allowable cable cross-section). There is a metal spring plate on the back of the module, which is used for effective grounding with the Din rail, and the metal spring plate is connected to the inside of the terminal PE of the adapter module.

1.4.4 Shielded Cable Connection

Cables carrying fast I/O, analog I/O and fieldbus communication signals must be shielded. The shielded cable must be firmly grounded. The fast I/O and analog I/O shields can be connected to the functional grounding or protective earthing (PE) of the C3351 expansion module. The fieldbus communication cable shields must be connected to protective earthing (PE) via using connection clamps fastened to the conductive backplane installed.

1.5 Wiring

Use push-in method to connect single-wire or crimp terminal wires without any other tools. Users can save wiring time and ensure a safe operation regardless of wiring experience.



The module equips with a wiring fixed end for cable harness, which is used to fix the cable when the IO module is wired with multiple cables.



⚠ WARNING

UNINTENDED EQUIPMENT OPERATION

Use shielded cables for all fast I/O, analog I/O, and communication signals.

Single-point grounding with shielded cables for all fast I/O, analog I/O, and communication signals.

Route power cables separately from communication cables and I/O cables.

Failure to follow instructions specified by the manufacturer may result in serious consequences such as death, personal injury, or damage to equipment since the protection provided by the equipment may be impaired.

⚠ AVERTISSEMENT

FONCTIONNEMENT INATTENDU DE L'EQUIPEMENT

Utilisez des câbles blindés pour toutes les entrées/sorties rapides, entrées/sorties analogiques et signaux de communication.

Mise à la terre en point unique à l'aide d'un câble blindé pour toutes les entrées/sorties rapides, entrées/sorties analogiques et signaux de communication.

Câblez les câbles d'alimentation séparément des câbles de communication et des câbles d'E/S.

Le fait de ne pas suivre les instructions peut entraîner une défaillance de la protection fournie par l'équipement, ce qui peut entraîner des conséquences graves, comme des blessures ou des dommages à l'équipement.

If connected to an equipotential ground to avoid damaging the cable shield in the event of a short circuit current in the power system, multi-point grounding is allowed (which in some cases is unavoidable).

Note: Surface temperatures may exceed 60°C (140°F).

To comply with the IEC-61010 standard, the main wiring (the wires connected to the main power supply) should be arranged separately and separated from the secondary wiring (the ultra-low voltage wiring from the intermediate power supply). If separate wiring is not possible, double insulation, such as conduit or cable gain, must be performed.

Note: Copper wire is required.

⚠ DANGER

FIRE HAZARD

Only use the correct wire rules for the maximum current capacity of the I/O channels and power supplies.

For relay output (2A) wiring, please use conductors with a cross-sectional area of at least 0.5 mm² (AWG20) and a temperature rating of at least 80°C (176°F).

Failure to follow instructions specified by the manufacturer may result in serious consequences such as death, personal injury, or damage to equipment since the protection provided by the equipment may be impaired.

1.6 Installation

1.6.1 Installation and maintenance requirements

The use and application of the information contained in this chapter requires expertise in the design and programming of automatic control systems. Only the user, machine builder or integrator can clearly understand the various situations and factors that may arise during installation and set-up, operation and maintenance, and therefore can determine the effective and correct use of automation and associated equipment, related safety devices and interlocks equipment. When selecting automation and control equipment and any other related equipment or software for a particular application, all applicable local, regional or national standards and/or regulations must also be considered.

In particular, observe any safety information, different electrical requirements and regulatory standards applicable to the machine or the use of the equipment.

If the equipment is used in a manner not specified by the manufacturer, the protection provided by the equipment may be impaired.

1.6.1.1 Environmental Requirements

All expansion module components must be electrically isolated between the internal circuit and the input/output channel, and the modules must be installed in a control cabinet or electric control room. The equipment is intended for use in industrial environments with pollution class 2 and altitudes below 2000 m.

⚠ WARNING
<p>UNEXPECTED EQUIPMENT OPERATION</p> <p>Do not exceed any ratings specified in the Environmental and Electrical Characteristics Table.</p> <p>Failure to follow instructions specified by the manufacturer may result in serious consequences such as death, personal injury, or damage to equipment since the protection provided by the equipment may be impaired.</p>
⚠ AVERTISSEMENT
<p>FONCTIONNEMENT INATTENDU DE L'ÉQUIPEMENT</p> <p>Ne dépassez aucune évaluation spécifiée dans le tableau de caractéristiques environnementales et électriques..</p> <p>Le fait de ne pas suivre les instructions peut entraîner une défaillance de la protection fournie par l'équipement, ce qui peut entraîner des conséquences graves, comme des blessures ou des dommages à l'équipement.</p>

 **WARNING**

UNINTENDED EQUIPMENT OPERATION

The modules are not suitable for use in harsh environments, such as environments with corrosive gases or salt spray.

Install and operate this equipment in accordance with the conditions described in "Environmental Characteristics".

Failure to follow instructions specified by the manufacturer may result in serious consequences such as death, personal injury, or damage to equipment since the protection provided by the equipment may be impaired.

 **AVERTISSEMENT**

FONCTIONNEMENT INATTENDU DE L'EQUIPEMENT

Le module ne convient pas aux environnements difficiles, par exemple avec des gaz corrosifs ou des environnements de brouillard salin.

Installez et faites fonctionner cet équipement selon les conditions décrites dans les caractéristiques environnementales.

Le fait de ne pas suivre les instructions peut entraîner une défaillance de la protection fournie par l'équipement, ce qui peut entraîner des conséquences graves, comme des blessures ou des dommages à l'équipement.

1.6.1.2 Installation Precautions

 WARNING
<p>UNINTENDED EQUIPMENT OPERATION</p> <p>Use appropriate safety interlocks in situations where there may be a risk of personal injury and/or equipment damage.</p> <p>Install and operate the equipment in an enclosure that is locked by a key locking device and complies with the level of the environment in which the equipment operates.</p> <p>Use the sensor and actuator power supply only for powering the sensors or actuators connected to the module.</p> <p>Wiring and output circuits must be wired and fused in accordance with local and national regulations for specific equipment rated amperage and voltage.</p> <p>Do not use this device in a safety-critical machine environment unless it is designated as a functional safety device and complies with applicable regulations and standards.</p> <p>Do not disassemble, repair or modify this equipment.</p> <p>Do not connect any lines to reserved unused connection points, or connection points indicated as No Connection (NC).</p> <p>Failure to follow instructions specified by the manufacturer may result in serious consequences such as death, personal injury, or damage to equipment since the protection provided by the equipment may be impaired.</p>
 AVERTISSEMENT
<p>FONCTIONNEMENT INATTENDU DE L'ÉQUIPEMENT</p> <p>Utiliser des dispositifs de verrouillage de sécurité appropriés dans les situations où il peut y avoir un risque de blessures corporelles et/ou de dommages à l'équipement.</p> <p>Installer et faire fonctionner l'équipement dans une enceinte verrouillée par un dispositif de verrouillage à clé et conforme au niveau de l'environnement dans lequel l'équipement fonctionne.</p> <p>Utilisez l'alimentation du capteur et de l'actionneur uniquement pour alimenter les capteurs ou les actionneurs connectés au module.</p> <p>Les circuits de câblage et de sortie doivent être câblés et fusionnés conformément aux réglementations locales et nationales pour l'ampérage et la tension nominale d'équipement spécifique.</p> <p>N'utilisez pas cet appareil dans un environnement de machine critique pour la sécurité, sauf s'il est désigné comme un dispositif de sécurité fonctionnel et conforme aux réglementations et aux normes applicables.</p> <p>Ne pas démonter, réparer ou modifier cet équipement.</p> <p>Ne connectez aucune ligne aux points de connexion inutilisés réservés, ou aux points de connexion indiqués comme aucune connexion (NC).</p> <p>Le fait de ne pas suivre les instructions peut entraîner une défaillance de la protection fournie par l'équipement, ce qui peut entraîner des conséquences graves, comme des blessures ou des dommages à l'équipement.</p>

1.6.1.3 Correct Installation

DIN-Rail Lock could be safely and reliably installed on 35 mm DIN-Rail. There is a manual closure buckle on the upper side of all modules for locking, and a manual buckle

is on the left side of the adapter for locking the guide rail.



⚠ WARNING

OUT OF CONTROL

The lock of the I/O module must be pressed firmly; otherwise, the communication of the I/O module may be disconnected.

The lock of the I/O module must be pressed firmly, otherwise the module may fall off.

When installing the I/O module, no gap should be left between the modules. Otherwise, the I/O channel may not work properly.

Failure to follow instructions specified by the manufacturer may result in serious consequences such as death, personal injury, or damage to equipment since the protection provided by the equipment may be impaired.

⚠ AVERTISSEMENT

PERTE DE CONTROLE

La boucle du module d'entrées/sorties doit être bloquée en place, faute de quoi la communication du bloc d'entrées/sorties peut échouer.

La boucle du module d'entrée/sortie doit être bloquée en place, sinon le module peut tomber.

Les modules d'entrées/sorties ne doivent pas être installés entre les modules. Autrement, les canaux d'entrées/sorties peuvent ne pas fonctionner correctement.

Le fait de ne pas suivre les instructions peut entraîner une défaillance de la protection fournie par l'équipement, ce qui peut entraîner des conséquences graves, comme des blessures ou des dommages à l'équipement.

NOTICE

DEVICE INOPERABLE

The installation position of the I/O module in the middle is not fixed. According to the layout position needed by customer, after the actual project confirms the installation position, it is not allowed to move the position of the I/O module.

Each station needs to add terminal modules.

Failure to follow the above instructions could result in damage to the equipment.

1.6.1.4 The Use of Power Modules

Power modules need to be added based on the actual number of I/O modules. The positions of power modules are not fixed between I/O modules. Therefore, the designer must determine the installation positions of power modules in advance.

WARNING

UNINTENDED EQUIPMENT OPERATION

If the total current of the I/O modules installed at the rear of the adapter device exceeds the provided current, but no power module is added, the I/O module channels will work abnormally.

Failure to follow instructions specified by the manufacturer may result in serious consequences such as death, personal injury, or damage to equipment since the protection provided by the equipment may be impaired.

AVERTISSEMENT

FONCTIONNEMENT INATTENDU DE L'EQUIPEMENT

Si le courant total des modules d'entrées/sorties montés à l'arrière de l'appareil dépasse le courant fourni sans que le module d'alimentation soit ajouté, le canal du module d'entrées/sorties fonctionnera de manière anormales.

Le fait de ne pas suivre les instructions peut entraîner une défaillance de la protection fournie par l'équipement, ce qui peut entraîner des conséquences graves, comme des blessures ou des dommages à l'équipement.

1.6.2 Removal

When the module is removed, it needs to manually unlock the guide rail on the upper side of the module. For the adapter module, you also need to unlock the left rail buckle counterclockwise.



 **WARNING**

UNINTENDED EQUIPMENT OPERATION

The module does not support the hot swap function. When removing or replacing a module, it is necessary to power off before removing or replacing the module.

When replacing I/O modules in later maintenance, please note that the model and slot number should be replaced correspondingly. It is not allowed to replace with the wrong module model or move the sequence of I/O modules at will, otherwise there will be a risk of burning out the module or damaging the field equipment.

Failure to follow instructions specified by the manufacturer may result in serious consequences such as death, personal injury, or damage to equipment since the protection provided by the equipment may be impaired.

 **AVERTISSEMENT**

FONCTIONNEMENT INATTENDU DE L'EQUIPEMENT

Le module ne prend pas en charge la fonction d'échange à chaud. Lorsque vous enlevez ou remplacez le module, vous devez mettre hors tension avant d'enlever ou de remplacer le module.

Lors du remplacement du module d'entrée/sortie après l'entretien, faites attention au numéro de modèle et de slot pour correspondre au remplacement, ne permet pas de remplacer le mauvais modèle de module, ne permet pas de déplacer aléatoirement l'ordre du module d'entrée/sortie, sinon il y aura un risque de brûler le module ou d'endommager l'équipement sur le site.

Le fait de ne pas suivre les instructions peut entraîner une défaillance de la protection fournie par l'équipement, ce qui peut entraîner des conséquences graves, comme des blessures ou des dommages à l'équipement.

1.6.3 Installation Clearance

When installing or removing a module, leave a minimum clearance.

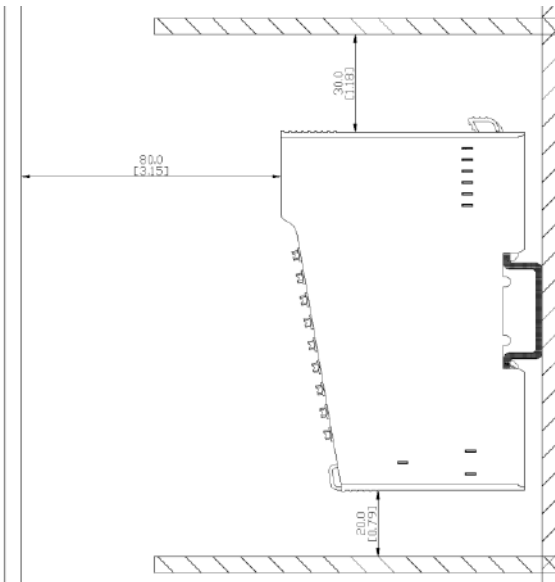
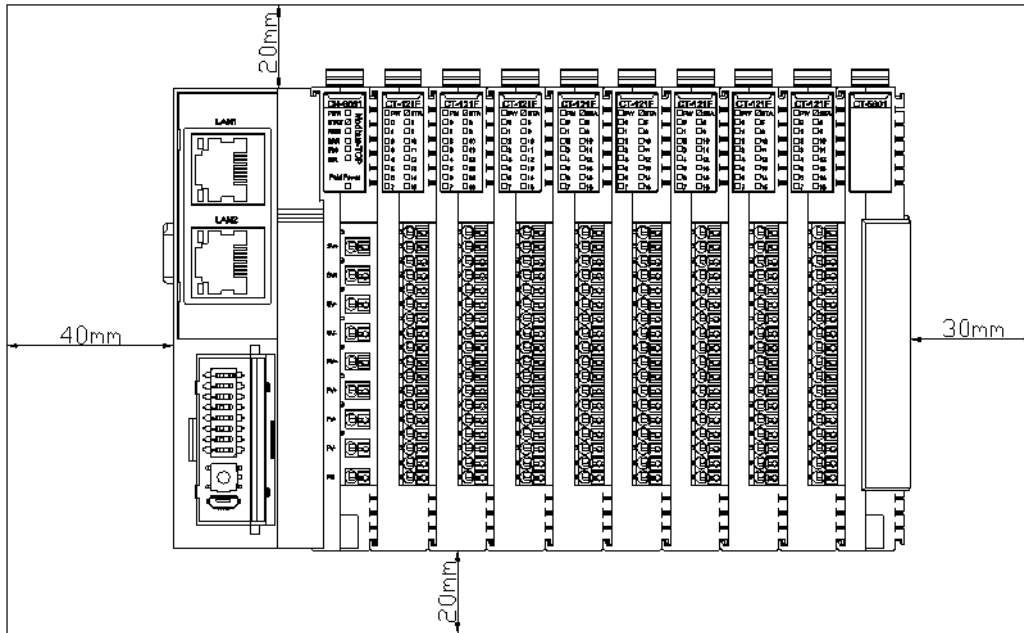

⚠ WARNING

UNINTENDED EQUIPMENT OPERATION

- Install the equipment that dissipates the most heat at the top of the cabinet to ensure proper ventilation.
- Please do not place this device near or above equipment that may cause overheating.
- Install the equipment so that it maintains the minimum clearances stated in this document to all

nearby structures and equipment.

· Install all equipment according to the specifications in the relevant documentation.

Failure to follow instructions specified by the manufacturer may result in serious consequences such as death, personal injury, or damage to equipment since the protection provided by the equipment may be impaired.

! AVERTISSEMENT

FONCTIONNEMENT INATTENDU DE L'ÉQUIPEMENT

Installez l'équipement qui dissipe le plus de chaleur sur le dessus de l'armoire pour assurer une ventilation appropriée.

Ne placez pas l'appareil à côté ou au-dessus d'un appareil qui pourrait causer une surchauffe.

Installez l'équipement à un endroit où l'espacement minimal décrit dans le présent document est maintenu avec toutes les structures et tous les équipements à proximité.

Installez tout l'équipement conformément aux spécifications de la documentation pertinente.

Le fait de ne pas suivre les instructions peut entraîner une défaillance de la protection fournie par l'équipement, ce qui peut entraîner des conséquences graves, comme des blessures ou des dommages à l'équipement.

1.6.4 Incorrect Installation Location

- A. The lock on the left side of the C3351 device is not pressed firmly to the Din rail.
- B. After the installation is completed, the lock on the upper side of the module is not pressed to lock the Din rail, or the pressed position is not in place.
- C. After the installation is completed, the lower part of the side of the module is not installed in place, and the module is not installed vertically, but is inclined to the backplane.
- D. There are gaps between modules.

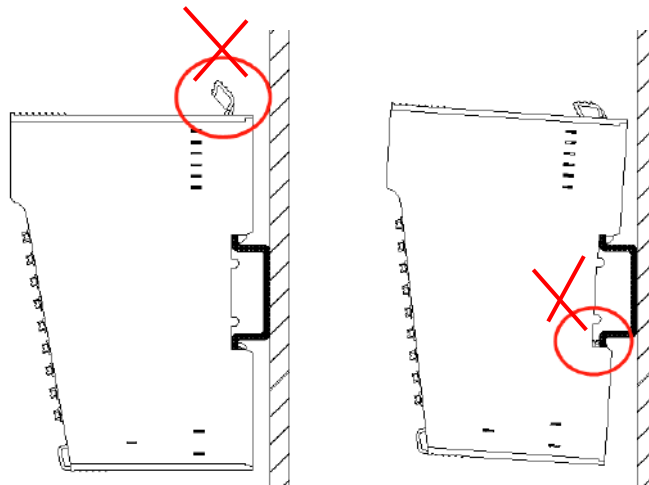

1.6.5 Installation Size

Adapter size: 115*51.5*75mm

I/O module size: 115*14*75mm



1.7 Power Supply

DANGER

FIRE HAZARD

Use only the correct wire specifications for the maximum current capacity of the power supply.

Failure to follow instructions specified by the manufacturer may result in serious consequences such as death, personal injury, or damage to equipment since the protection provided by the equipment may be impaired.

WARNING

UNINTENDED EQUIPMENT OPERATION

Please do not exceed any ratings specified in the Environmental and Electrical Characteristics table.

Failure to follow instructions specified by the manufacturer may result in serious consequences such as death, personal injury, or damage to equipment since the protection provided by the equipment may be impaired.

AVERTISSEMENT

FONCTIONNEMENT INATTENDU DE L'EQUIPEMENT

Ne dépassez aucune évaluation spécifiée dans le tableau de caractéristiques environnementales et électriques..

Le fait de ne pas suivre les instructions peut entraîner une défaillance de la protection fournie par l'équipement, ce qui peut entraîner des conséquences graves, comme des blessures ou des dommages à l'équipement.

The device and associated expansion modules require a power supply rated at 24 VDC. According to IEC 61140, the 24 VDC power supply must be rated safety extra-low voltage (SELV) or protective extra-low voltage (PELV). These power supplies are isolated between its electrical input and output circuit.

 **WARNING**

OVERHEATING AND FIRE HAZARD

Never connect the device directly to the line voltage.

Please use only insulated SELV or PELV power supply to power the device.

Failure to follow instructions specified by the manufacturer may result in serious consequences such as death, personal injury, or damage to equipment since the protection provided by the equipment may be impaired.

 **AVERTISSEMENT**

SURCHAUFFE ET RISQUE D'INCENDIE

Ne connectez jamais l'appareil directement à la tension de la ligne.

Veillez utiliser uniquement une alimentation électrique SELV ou PELV isolée pour alimenter l'appareil.

Le fait de ne pas suivre les instructions peut entraîner une défaillance de la protection fournie par l'équipement, ce qui peut entraîner des conséquences graves, comme des blessures ou des dommages à l'équipement.

1.8 Ventilation Requirements

NOTICE

IO module, please install in the control cabinet with door lock (control cabinet shell protection >IP20);

Installation can not be placed under the heat generating elements, the surrounding ventilation and heat dissipation space should be large enough, there should be more than 30MM between the basic unit and the expansion unit;

The upper and lower parts of the switchgear should have ventilated shutters to prevent direct sunlight exposure;

During installation, avoid metal shavings and wire tips falling into the controller's ventilation holes, which may cause fire, failure, and misoperation.

Failure to follow the above instructions could result in damage to the equipment.

1.9 Scrap Processing

Scrap condition:

1. The use time has exceeded the specified service life, the main structure is obsolete, the components are aging, the performance indicators are reduced, and the basic requirements of use are not met;
2. The damage is so severe that it is beyond repair or the repair cost is close to or exceeds the price of the new purchase of similar electronic equipment;
3. Serious pollution of the environment endangers personal safety and health, technical transformation is difficult or the cost of transformation is uneconomical;
4. Backward technical performance, high energy consumption, low efficiency, maintenance and use of uneconomical.
5. The quality is inferior, does not meet the technical standards, and does not meet the minimum performance indicators in the application.
6. Equipment that cannot be used for other reasons and should not be transferred to other enterprises without retaining value.

WARNING

Since this product cannot be discarded with other household waste, when the end user intends to discard this product, it must be sent to the appropriate facility for recovery and recycling.

Do not discard directly in the trash.

Comply with the relevant laws and regulations, the destruction process should choose a legitimate organization for processing.

AVERTISSEMENT

Comme ce produit ne peut pas être jeté avec d'autres ordures ménagères, lorsque l'utilisateur final a l'intention de jeter ce produit, il doit être envoyé à l'installation appropriée pour la récupération et le recyclage.

Ne pas jeter directement à la poubelle.

Se conformer aux lois et règlements pertinents, le processus de destruction doit choisir une organisation légitime pour le traitement.

1.10 Equipment maintenance and repair

NOTICE

It is prohibited to replace the detachable power cord with an inappropriate rated wire.

Any parts that can only be inspected or supplied by the manufacturer or its agents.

Only for the manufacture of electrical equipment and the operation of personnel with relevant skills and knowledge.

Confirm the safety status of the equipment after maintenance

Failure to follow the above instructions could result in damage to the equipment.

1.11 UL certification

There are 43 modules listed in the table below that are UL certified.

Number	Module number
1	CN-8011
2	CN-8021
3	CN-8032-L
4	CN-8032
5	CN-8033
6	CN-8034
7	CN-8037
8	CT-124H
9	CT-124D
10	CT-1218
11	CT-121F
12	CT-1314
13	CT-2218
14	CT-221F
15	CT-221H
16	CT-221D

17	CT-2224
18	CT-2228
19	CT-222F
20	CT-222H
21	CT-222D
22	CT-623F
23	CT-3234
24	CT-3238
25	CT-3734
26	CT-3744
27	CT-4154
28	CT-4158
29	CT-5102
30	CT-5112
31	CT-5122
32	CT-5142
33	CT-5321
34	CT-5331
35	CT-5341
36	CT-5801
37	CT-7100
38	CT-7220
39	CT-730F
40	CT-731F
41	CT-732F
42	CT-7339
43	CT-7346

2 BUS Adapter & Network Adapter

CN-8011 Modbus-RTU Bus Adapter

1 Module Overview

CN-8011 Modbus-RTU bus adapter supports standard Modbus-RTU communication, it supports function code of 01/02/03/04/05/06/15/16/23, and this device could monitor the IO module communication state in real time.

2 Technical Parameter

Hardware Parameter	
System Power	Nominal:24VDC, Range: 20-30VDC Current: Max.2A@24VDC Protection: Reverse Protection, Overcurrent Protection
Power Consumption	30mA@24VDC
Internal Bus Supply Current	Max: 2.5A@5VDC
Isolation	System Power to Field Power Isolation
Power Supply	Nominal:24VDC, Range:20.4-28.8VDC
Field Power Current	Max. DC 8A
IO Modules Supported	32 pcs
Wiring	Max.: AWG 18 Min.: AWG 24
Installation	35mm DIN-Rail
Size	115*51.5*75mm
Weight	130g
Environment Specification	
Operating Temperature of Horizontal Installation	-35°C~70°C
Operating Temperature of Vertical Installation	-35°C~60°C
Relative Humidity	< 95%RH (No Condensation)
Storage Temperature	-40°C~85°C
Storage Humidity	< 95%RH (No Condensation)
Manufacturing Test Temperature	-40°C~75°C
Ingress Protection Rating	IP20
Modbus-RTU Parameter	
Protocol	Modbus-RTU/ASCII
Function Code	01 / 02 / 03 / 04 / 05 / 06 / 15 / 16 / 23
Baud Rate	2400~115200bps
Station No.	1~63(Dial-code switch configuration),64~247(Software configuration)
Interface	5 Pin screw terminal
Data Bits	7, 8
Parity Checking	N/A, Even, ODD
Stop Bit	1, 2
Max. Bus Length	1200m (RS485, 2400 baud rate)
Terminal resistance and offset resistance	DIP switch configuration

  **DANGER**

THERE IS A RISK OF ELECTRIC SHOCK, EXPLOSION, OR ARC FLASH.

Disconnect all devices from power, including connected devices, before removing any covers, or installing or removing any accessories, hardware, cables, or wires, except in specific circumstances specified in the appropriate hardware guidelines for this device.

Always use a voltage sensing device with an appropriate rating to detect a power outage at the appropriate place and time, as instructed.

Replace and tighten all covers, accessories, hardware, cables, and wires, and confirm that the ground connection is correct before powering on the device.

When operating this equipment and related products, the specified voltage must be used.

Failure to follow instructions specified by the manufacturer may result in serious consequences such as death, personal injury, or damage to equipment since the protection provided by the equipment may be impaired.

3 Hardware Interface

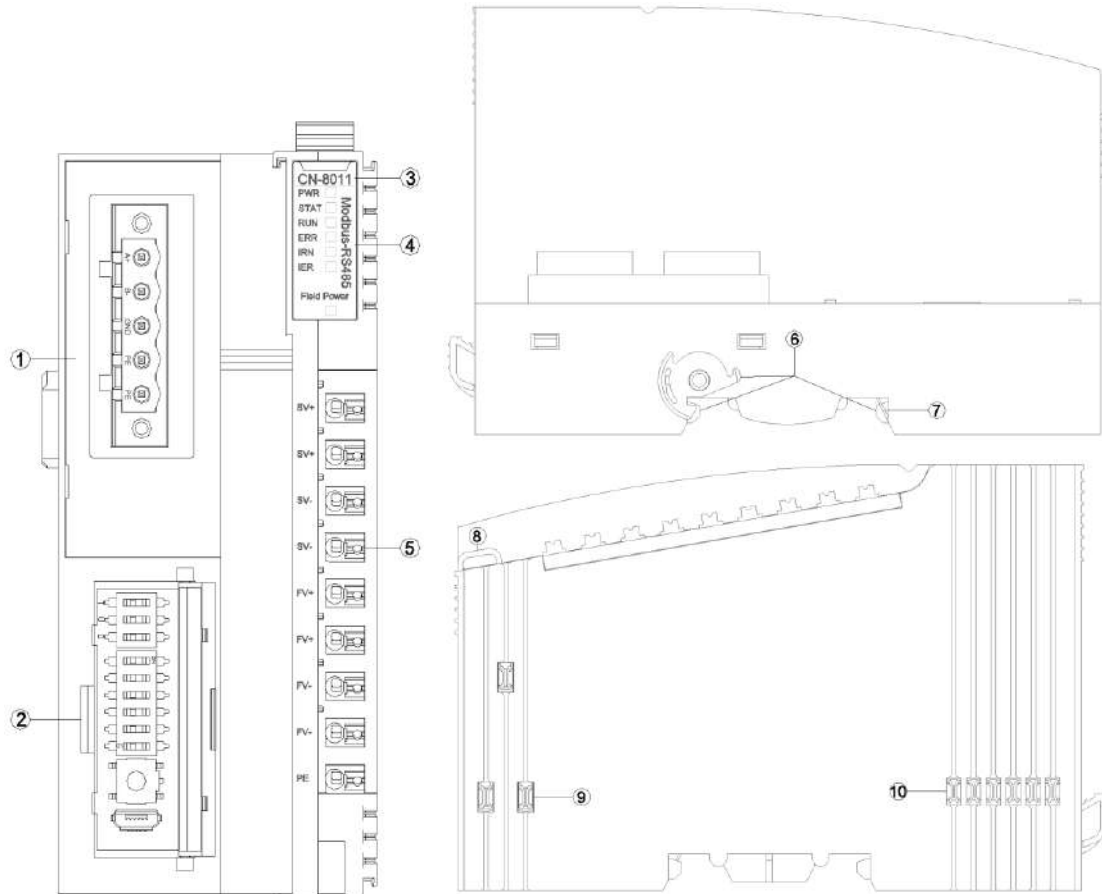

- ① RS485 port
- ② Config Interface
- ③ Module type
- ④ LED Indicator
- ⑤ Wiring Terminal
- ⑥ Buckle
- ⑦ Grounding Spring Sheet
- ⑧ Fixed Wiring Harness
- ⑨ Field Power
- ⑩ Internal Bus

3.1 RS485 Interface

Modbus RS485 port is 5 Pin screw terminals and its Pin definition is as below:

Pin	Definition	Description
1	A+	RS485 A+
2	B-	RS485 B-
3	SGND	Signal Grounded
4	Shield	Earthing of Shield
5	PE	Protect Earthing

3.2 Configuration Interface

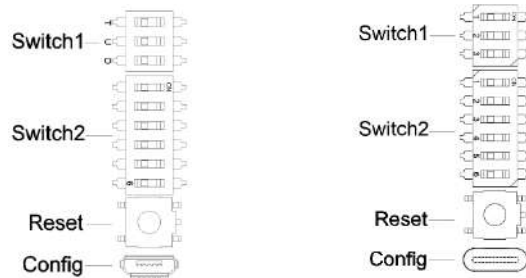

Switch1: DIP switch used to set the terminal resistance, pull up and down resistance. T: terminal resistance, U: pull up resistance, D: pull down resistance.

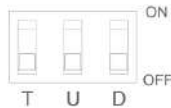

Switch2: DIP switch used to set the adapter module address. It is set by a 6-bit binary hardware dial - code switch, and each Modbus adapter has a unique station address (1~63).

(Special note: When the address needs to be set beyond 63, the address should be dialed to set it to 0, and the station address should be set in IO Config software)

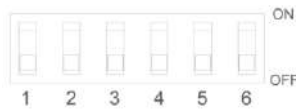

Reset: Module reset button, long pressing the button for more than 5 seconds and all parameters of the module will be restored to the default value. When the Reset button is activated, a green indicator will light up in the upper left corner of the button.

Config: configured ports, it is standard Micro USB/Type-C interface for configuring device parameters and firmware upgrades.

3.3 LED Indicator

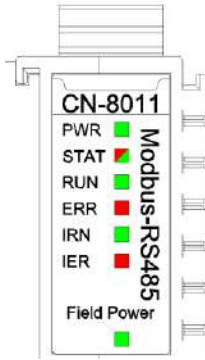

PWR Power State (GREEN)	Definition
ON	System Power Normal
OFF	System Power Failure
STAT Module State (RED/GREEN)	Definition
Double Flash (RED)	Module Soft Restarted by Hard-Fault
ON(GREEN)	Running
Single Flash (GREEN)	Stopping
Flash(2.5Hz) (RED/GREEN)	Boot Mode
Flash(10Hz) (RED/GREEN)	Firmware Updating
RUN Network State (GREEN)	Definition
OFF	No data exchanging.
Flash	Modbus data exchanging
ERR Network Error (RED)	Definition
OFF	Modbus data exchanging normal
ON	Modbus data exchanging failure
IRN IO Run (GREEN)	Definition
ON	IO Initialization Normal
OFF	IO Initialization Failure
IER IO Error (RED)	Definition
OFF	IO Communication Normal
Double Flash	IO Communication Failure
Field Power State (GREEN)	Definition
ON	Field Power Normal
OFF	Field Power Failure

WARNING

UNEXPECTED EQUIPMENT OPERATION

By viewing the PW indicator, could determine the power supply status of a module. If the PW is steady green, the power supply is normal. Otherwise, the module cannot work properly.

When the module is initially powered on, there will be 3S for the backplane bus connection. After the backplane bus is initialized, STA is in the green steady state. If STA is in the green blinking state, it indicates that the backplane bus has not been initialized, and it needs to be powered off and restarted for re-initialization.

STA abnormal working state occurs during the normal operation of the module, please check the firmware version information of all modules, and consult ODOT technical support for details.

If a module is upgraded, check that all modules are in the normal state after the upgrade. Otherwise, an exception may occur.

Failure to follow instructions specified by the manufacturer may result in serious consequences such as death, personal injury, or damage to equipment since the protection provided by the equipment may be impaired.

AVERTISSEMENT

FONCTIONNEMENT INATTENDU DE L'EQUIPEMENT

En regardant l'état de l'indicateur de PW, jugez l'état d'alimentation du module. Le feu vert PW reste allumé et l'alimentation est normale. Autrement, le module ne fonctionnera pas correctement.

Lorsque le module est alimenté initialement, il y aura 3S pour la connexion de bus de backboard. STA est un état vert permanent après l'initialisation du bus de backboard. Si STA est en état de clignotement vert, cela signifie que l'initialisation du bus de backboard n'est pas passée et doit être redémarrée hors tension et réinitialisée.

L'état de fonctionnement anormal de STA se produit pendant le fonctionnement normal du module, veuillez vérifier les informations de version du firmware de tous les modules, et consulter le support technique ODOT pour plus de détails.

Si le module a une opération de mise à niveau, après l'achèvement de la mise à niveau, le besoin de vérifier que tous les modules sont dans l'état normal avant de courir, sinon il conduira à une exception.

Le fait de ne pas suivre les instructions peut entraîner une défaillance de la protection fournie par l'équipement, ce qui peut entraîner des conséquences graves, comme des blessures ou des dommages à l'équipement.

4 Wiring

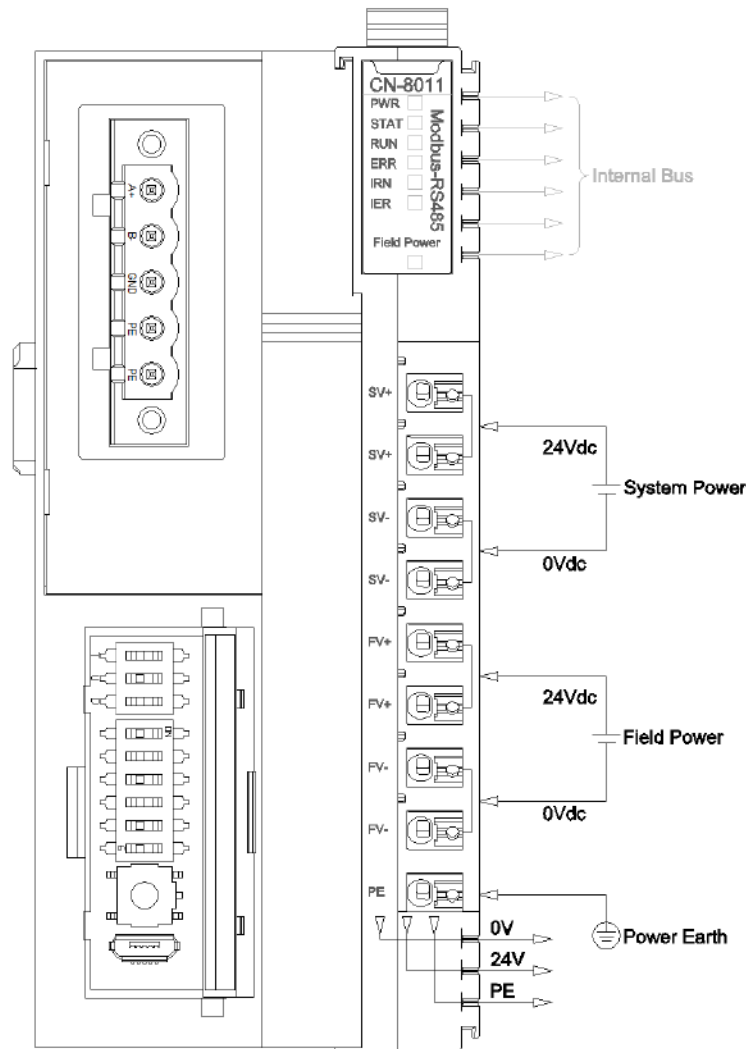

NOTICE

UNEXPECTED DEVICE OPERATION

Inside the module, two terminal blocks SV+ have been shorted, two terminal blocks SV - have been shorted, two terminal blocks FV+ have been shorted, and two terminal blocks FV - have been shorted. Externally, only one system power supply and one field power supply need to be connected.

The wire should be copper wire with a core greater than 0.2mm² and less than 1mm², and the impedance is less than 10Ω.

Failure to follow instructions specified by the manufacturer may result in serious consequences such as death, personal injury, or damage to equipment since the protection provided by the equipment may be impaired.

5 Process data definition

5.1 Adapter process data definition

Modbus-RTU Adapter itself has no input-output process data.

5.2 IO Module process data mapping

The network adapter reads and writes input and output process data of IO module in real time through the internal bus, and its data mapping model is shown as follow:

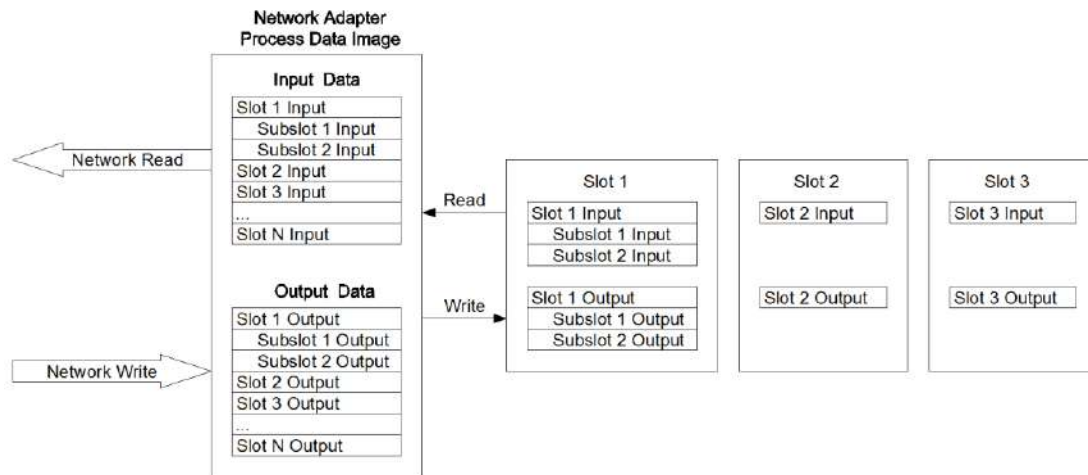

Modbus address mapping table varies according to module combination, and detailed address mapping table could be viewed through IO Config – the configuration software.

6 Configuration Parameter Definition

Configuration Parameter								
Bit No	Bit 7	Bit 6	Bit 5	Bit 4	Bit 3	Bit 2	Bit 1	Bit 0
Byte 0						Fault Action for Output	Fault Action for Input	Source of Configuration Data
Byte 1	Slave ID							
Byte 2	BaudRate							
Byte 3								
Byte 4								
Byte 5								
Byte 6		Serial Mode	Stop Bits		Parity Bits		Data Bits	
Byte 7	Char Pitch							
Byte 8	Response Delay(ms)							
Byte 9								

Data description:

Source of Config Data: Parameter configuration mode (Default: 0)

0: Configuration Software

Fault Action for Input: Input fault handling mode, when IO module is offline, the adapter will process IO module input data according to this mode. (Default: 0, Hold Last Input Value)

0: Hold Last Input Value

1: Clear Input Value

Fault Action for Output: Output fault handling mode, when the IO module is offline, the adapter will process the IO module output data according to this mode. (Default: 1, Clearing Output Value)

0: Hold Last Output Value

1: Clearing Output Value

Slave ID: Modbus slave ID, hardware dial code or software configuration, 1-247

Baud Rate: Serial port baud rate, (Default: 2, 9600bps)

0: 2400bps

1: 4800bps

- 2: 9600bps
- 3: 14400bps
- 4: 19200bps
- 5: 38400bps
- 6: 57600bps
- 7: 115200bps

Data Bits: data bits, (default: 1, 8 bits)

- 0: 7 bits
- 1: 8 bits

Parity Bits: Parity Checking, (default: 0, no parity)

- 0: N/A
- 1: ODD
- 2: EVEN

Stop Bits: stop bits, (default: 0, 1 bits)

- 0: 1 bits
- 1: 2 bits

Serial Mode: Serial port mode (default: 0, RTU)

- 0: RTU
- 1: ASCII

Char Pitch: Character Pitch is the detection time of frame interval when receiving a message (T is the time of single character transmission, related to baud rate) (default: 2, 5 characters)

- 0: 1.5 characters
- 1: 3.5 characters
- 2: 5 characters
- 3: 10 characters
- 4: 20 characters
- 5: 50 characters

6: 100 characters

7: 200 characters

Response Delay(ms): Reply delay time from Slave, self-defined, default 10ms, effective range: 0-65535.

7 System diagnostic area

The "State input" storage area, address 0x2000 ~ 0x2068, a total of 105 Words.

No.	Storage Type	Description	Storage Capacity	Address Range	Read-write
1	3 Area	System diagnosis - Status input	105 Word	0x2000~0x2068	RO

Modbus client monitors the address area 0x2000~0x2068 by calling Modbus 04 function code to obtain the current working status and error code of the adapter and IO module, the data format is shown as below:

No.	Modbus Address (Decimalism)	Address (Hexadecimal)	Data Name	Description
1	8192	0x2000	<u>Reset Mode</u>	Reset State*
2	8193	0x2001	Reserve	
3	8194	0x2002	DIP switch value	
4	8195	0x2003	Running time - Second	
5	8196	0x2004	Running time - Minute	
6	8197	0x2005	Running time - Hour	
7	8198	0x2006	Running time - Day	
8	8199	0x2007	N/A	Reserved
9	8200	0x2008		
10	8201	0x2009		
11	8202	0x200A		
12	8203	0x200B		
13	8204	0x200C		
14	8205	0x200D		
15	8206	0x200E		
16	8207	0x200F		
17	8208	0x2010	DI-size	Discrete quantity input area data size
18	8209	0x2011	DO-size	Coil output area data size
19	8210	0x2012	AI-size	Input register area data size
20	8211	0x2013	AO-size	Holding register area data size
21	8212	0x2014	N/A	Reserved
22	8213	0x2015		
23	8214	0x2016		
24	8215	0x2017		
25	8216	0x2018		
26	8217	0x2019		
27	8218	0x201A		

28	8219	0x201B		
29	8220	0x201C		
30	8221	0x201D		
31	8222	0x201E		
32	8223	0x201F		
33	8224	0x2020		
34	8225	0x2021		
35	8226	0x2022		
36	8227	0x2023		
37	8228	0x2024		
38	8229	0x2025		
39	8230	0x2026		
40	8231	0x2027	Module_Error[0]	Module 0 error code
41	8232	0x2028		
42	8233	0x2029	Module_Error[1]	Module 1 error code
43	8234	0x202A		
44	8235	0x202B	Module_Error[2]	Module 2 error code
45	8236	0x202C		
46	8237	0x202D	Module_Error[3]	Module 3 error code
47	8238	0x202E		
48	8239	0x202F	Module_Error[4]	Module 4 error code
49	8240	0x2030		
50	8241	0x2031	Module_Error[5]	Module 5 error code
51	8242	0x2032		
52	8243	0x2033	Module_Error[6]	Module 6 error code
53	8244	0x2034		
54	8245	0x2035	Module_Error[7]	Module 7 error code
55	8246	0x2036		
56	8247	0x2037	Module_Error[8]	Module 8 error code
57	8248	0x2038		
58	8249	0x2039	Module_Error[9]	Module 9 error code
59	8250	0x203A		
60	8251	0x203B	Module_Error[10]	Module 10 error code
61	8252	0x203C		
62	8253	0x203D	Module_Error[11]	Module 11 error code
63	8254	0x203E		
64	8255	0x203F	Module_Error[12]	Module 12 error code
65	8256	0x2040		
66	8257	0x2041	Module_Error[13]	Module 13 error code
67	8258	0x2042		
68	8259	0x2043	Module_Error[14]	Module 14 error code
69	8260	0x2044		
70	8261	0x2045	Module_Error[15]	Module 15 error code

71	8262	0x2046		
72	8263	0x2047	Module_Error[16]	Module 16 error code
73	8264	0x2048		
74	8265	0x2049	Module_Error[17]	Module 17 error code
75	8266	0x204A		
76	8267	0x204B	Module_Error[18]	Module 18 error code
77	8268	0x204C		
78	8269	0x204D	Module_Error[19]	Module 19 error code
79	8270	0x204E		
80	8271	0x204F	Module_Error[20]	Module 20 error code
81	8272	0x2050		
82	8273	0x2051	Module_Error[21]	Module 21 error code
83	8274	0x2052		
84	8275	0x2053	Module_Error[22]	Module 22 error code
85	8276	0x2054		
86	8277	0x2055	Module_Error[23]	Module 23 error code
87	8278	0x2056		
88	8279	0x2057	Module_Error[24]	Module 24 error code
89	8280	0x2058		
90	8281	0x2059	Module_Error[25]	Module 25 error code
91	8282	0x205A		
92	8283	0x205B	Module_Error[26]	Module 26 error code
93	8284	0x205C		
94	8285	0x205D	Module_Error[27]	Module 27 error code
95	8286	0x205E		
96	8287	0x205F	Module_Error[28]	Module 28 error code
97	8288	0x2060		
98	8289	0x2061	Module_Error[29]	Module 29 error code
99	8290	0x2062		
100	8291	0x2063	Module_Error[30]	Module 30 error code
101	8292	0x2064		
102	8293	0x2065	Module_Error[31]	Module 31 error code
103	8294	0x2066		
104	8295	0x2067	Module_Error[32]	Module 32 error code
105	8296	0x2068		

*Reset state Register 38193 address data format is shown as below:

Address offset	Address name	Description	Power on default value
Bit 0	Power_On_Reset	Power on reset	0/1
Bit 1-3	Reserved	Reserved	0
Bit 4	External_Reset	External Reset	0/1
Bit 5	Reserved	Reserved	0
Bit 6	Soft_Reset_Request	Soft Reset	0

Bit 7	Reserved	Reserved	0
Bit 8	HardFault	Hard Fault Reset	0
Bit 9	StackOver	Stack Over Reset	0
Bit 10	MemoryOver	Memory Over Reset	0
Bit 11-15	Reserved	Reserved	0

A Dimension drawing

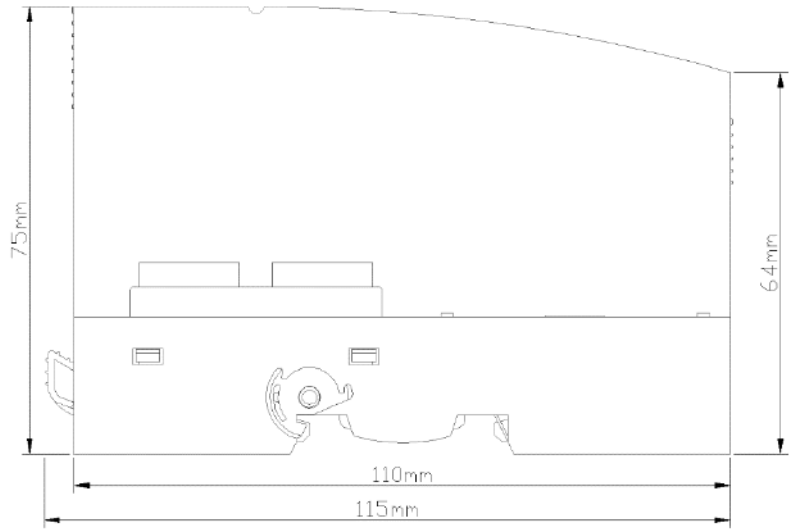
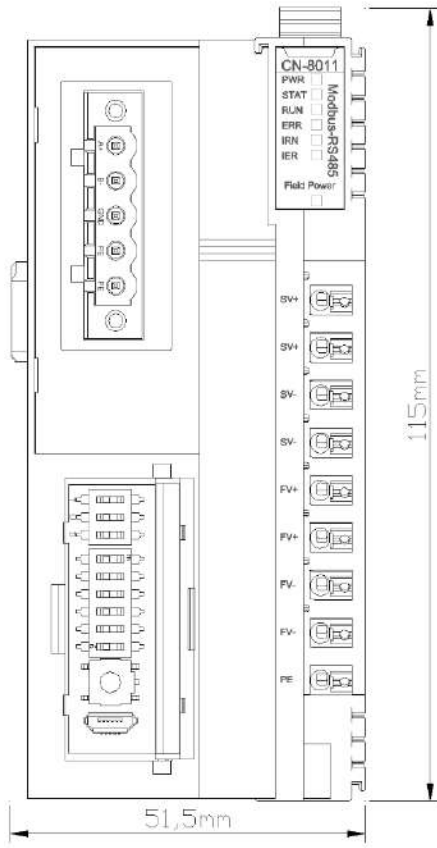

CN-8012 Profibus-DP Bus Adapter

1 Module Overview

CN-8012 PROFIBUS-DP bus adapter supports access of standard PROFIBUS-DP, and the protocol version it supports is DPV0.

2 Technical Parameter

Hardware Parameter	
System Power	Nominal:24VDC, Range: 20-30VDC Current: Max.2A@24VDC Protection: Reverse Protection, Overcurrent Protection
Power Consumption	30mA@24VDC
Internal Bus Supply Current	Max.: 2.5A@5VDC
Isolation	System Power to Field Power Isolation
Power Supply	Nominal:24VDC, Range:20.4-28.8VDC
Field Power Current	Max. DC 8A
IO Modules Supported	32 pcs
Wiring	Max.: AWG 18 Min.: AWG 24
Installation	35mm DIN-Rail
Size	115*51.5*75mm
Weight	130g
Environment Specification	
Operating Temperature of Horizontal Installation	-35°C~70°C
Operating Temperature of Vertical Installation	-35°C~60°C
Relative Humidity	< 95%RH (No Condensation)
Storage Temperature	-40°C~85°C
Storage Humidity	< 95%RH (No Condensation)
Manufacturing Test Temperature	-40°C~75°C
Ingress Protection Rating	IP20
Profibus-DP Parameter	
Protocol	PROFIBUS DPV0
Baud rate	9.6k, 19.2k, 45.45 k, 93.75 k, 187.5 k, 500 k, 1.5 M, 3 M, 6 M, 12 Mbps
Interface Type	DB9 female head
Station Type	PROFIBUS Slave
Station Address	Dial code switch configuration
Topology	Bus Topology
Configuration Max. Length	232 bytes
IO Data Max. Length	Input: Max. 244 bytes, Output: Max. 244 bytes, Sum of input and out put: Max. 288 bytes

  **DANGER**

THERE IS A RISK OF ELECTRIC SHOCK, EXPLOSION, OR ARC FLASH.

Disconnect all devices from power, including connected devices, before removing any covers, or installing or removing any accessories, hardware, cables, or wires, except in specific circumstances specified in the appropriate hardware guidelines for this device.

Always use a voltage sensing device with an appropriate rating to detect a power outage at the appropriate place and time, as instructed.

Replace and tighten all covers, accessories, hardware, cables, and wires, and confirm that the ground connection is correct before powering on the device.

When operating this equipment and related products, the specified voltage must be used.

Failure to follow instructions specified by the manufacturer may result in serious consequences such as death, personal injury, or damage to equipment since the protection provided by the equipment may be impaired.

3 Hardware Interface

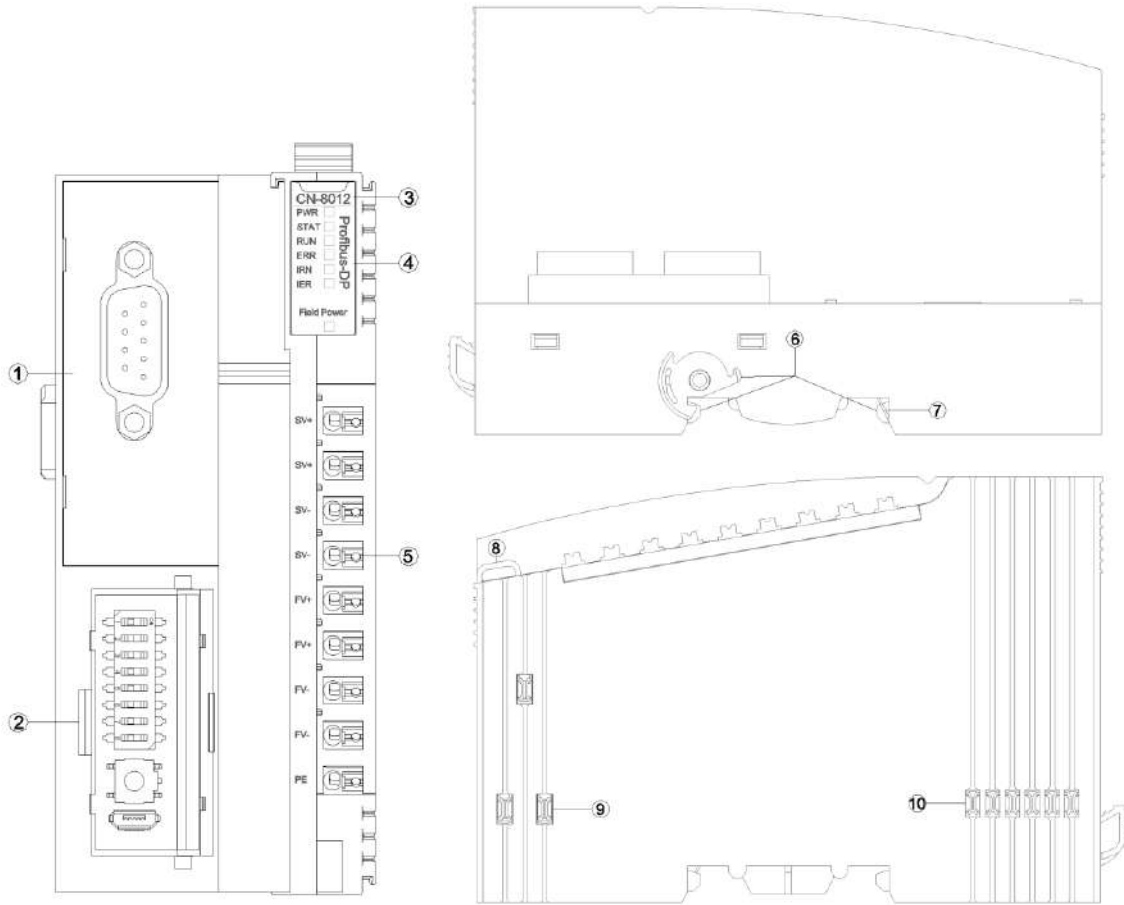

- ① Profibus-DP port
- ② Config Interface
- ③ Module type
- ④ LED Indicator
- ⑤ Wiring Terminal
- ⑥ Buckle
- ⑦ Grounding Spring Sheet
- ⑧ Fixed Wiring Harness
- ⑨ Field Power
- ⑩ Internal Bus

3.1 Profibus-DP Interface

Profibus-DP port is 9 Pin terminals and its Pin definition is as below:

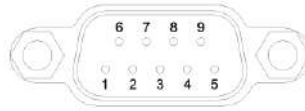

Interface Pin Definition

Pin	Definition	Description
1	Shield	Earthing of Shield
2	--	--
3	B	Data line B
4	CNTR-P	Direction control-P
5	DGND	Signal Grounded
6	VP(+)	+5v
7	--	--
8	A	Data lineA
9	CNTR-N	Direction control-N

3.2 Configuration Interface

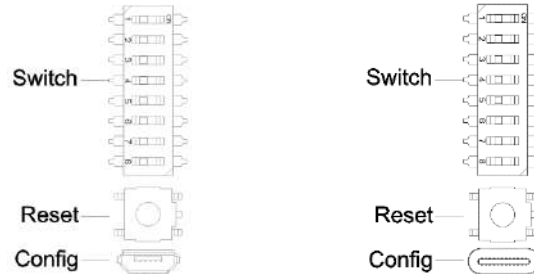

Switch: The station addresses of the Profibus DP adapter. It is set by an 8-bit binary hardware dial code switch, and each PROFIBUS adapter has a unique station address (1~127).

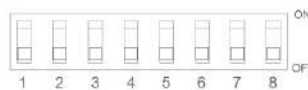

Reset: Module reset button, long pressing the button for more than 5 seconds and all parameters of the module will be restored to the default value. When the Reset button is activated, a green indicator will light up in the upper left corner of the button.

Config: configured ports, it is standard Micro USB/Type-C interface for configuring device parameters and firmware upgrades.

3.3 LED Indicator

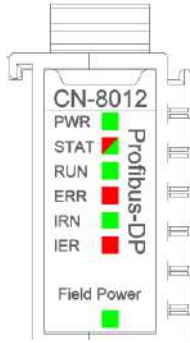

PWR Power State (GREEN)	Definition
ON	System Power Normal
OFF	System Power Failure
STAT Module State (RED/GREEN)	Definition
Double Flash (RED)	Module Soft Restarted by Hard-Fault
ON(GREEN)	Running
Single Flash (GREEN)	Stopping
Flash(2.5Hz) (RED/GREEN)	Boot Mode
Flash(10Hz) (RED/GREEN)	Firmware Updating
RUN Network State (GREEN)	Definition
OFF	DP off-line mode
ON	DP data exchanging mode
ERR Network Error (RED)	Definition
Off	DP data exchanging mode
Flash	DP off-line mode
IRN IO Run (GREEN)	Definition
ON	IO Initialization Normal
OFF	IO Initialization Failure
IER IO Error (RED)	Definition
OFF	IO Communication Normal
Double Flash	IO Communication Failure
Field Power State (GREEN)	Definition
ON	Field Power Normal
OFF	Field Power Failure

WARNING

UNEXPECTED EQUIPMENT OPERATION

By viewing the PW indicator, could determine the power supply status of a module. If the PW is steady green, the power supply is normal. Otherwise, the module cannot work properly.

When the module is initially powered on, there will be 3S for the backplane bus connection. After the backplane bus is initialized, STA is in the green steady state. If STA is in the green blinking state, it indicates that the backplane bus has not been initialized, and it needs to be powered off and restarted for re-initialization.

STA abnormal working state occurs during the normal operation of the module, please check the firmware version information of all modules, and consult ODOT technical support for details.

If a module is upgraded, check that all modules are in the normal state after the upgrade. Otherwise, an exception may occur.

Failure to follow instructions specified by the manufacturer may result in serious consequences such as death, personal injury, or damage to equipment since the protection provided by the equipment may be impaired.

AVERTISSEMENT

FONCTIONNEMENT INATTENDU DE L'EQUIPEMENT

En regardant l'état de l'indicateur de PW, jugez l'état d'alimentation du module. Le feu vert PW reste allumé et l'alimentation est normale. Autrement, le module ne fonctionnera pas correctement.

Lorsque le module est alimenté initialement, il y aura 3S pour la connexion de bus de backboard. STA est un état vert permanent après l'initialisation du bus de backboard. Si STA est en état de clignotement vert, cela signifie que l'initialisation du bus de backboard n'est pas passée et doit être redémarrée hors tension et réinitialisée.

L'état de fonctionnement anormal de STA se produit pendant le fonctionnement normal du module, veuillez vérifier les informations de version du firmware de tous les modules, et consulter le support technique ODOT pour plus de détails.

Si le module a une opération de mise à niveau, après l'achèvement de la mise à niveau, le besoin de vérifier que tous les modules sont dans l'état normal avant de courir, sinon il conduira à une exception.

Le fait de ne pas suivre les instructions peut entraîner une défaillance de la protection fournie par l'équipement, ce qui peut entraîner des conséquences graves, comme des blessures ou des dommages à l'équipement.

4 Wiring

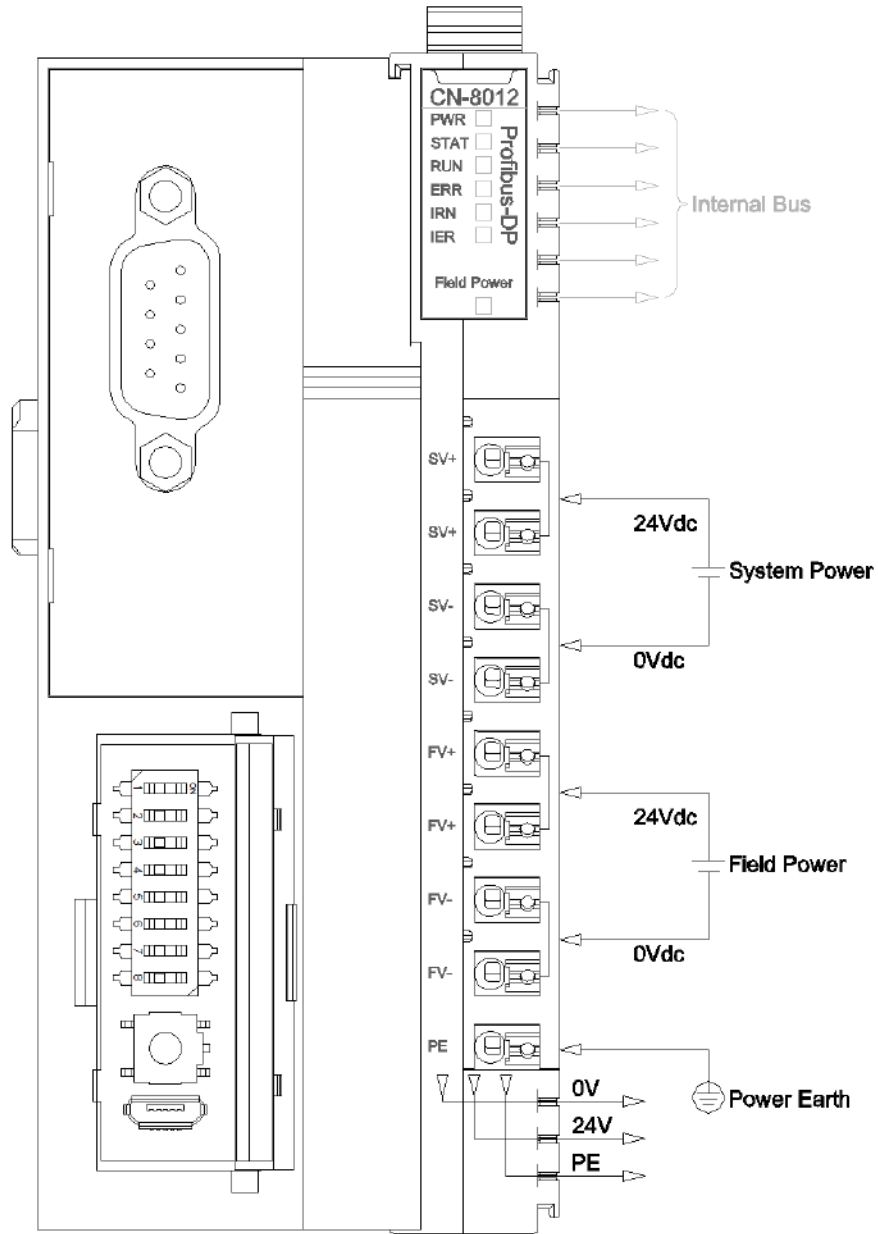

NOTICE

UNEXPECTED DEVICE OPERATION

Inside the module, two terminal blocks SV+ have been shorted, two terminal blocks SV - have been shorted, two terminal blocks FV+ have been shorted, and two terminal blocks FV - have been shorted. Externally, only one system power supply and one field power supply need to be connected.

The wire should be copper wire with a core greater than 0.2mm^2 and less than 1mm^2 , and the impedance is less than 10Ω .

Failure to follow instructions specified by the manufacturer may result in serious consequences such as death, personal injury, or damage to equipment since the protection provided by the equipment may be impaired.

5 Process data definition

5.1 Adapter process data definition

Profibus-DP Adapter itself has no input-output process data.

5.2 IO Module process data mapping

The network adapter reads and writes input and output process data of IO module in real time through the internal bus, and its data mapping model is shown as follow:

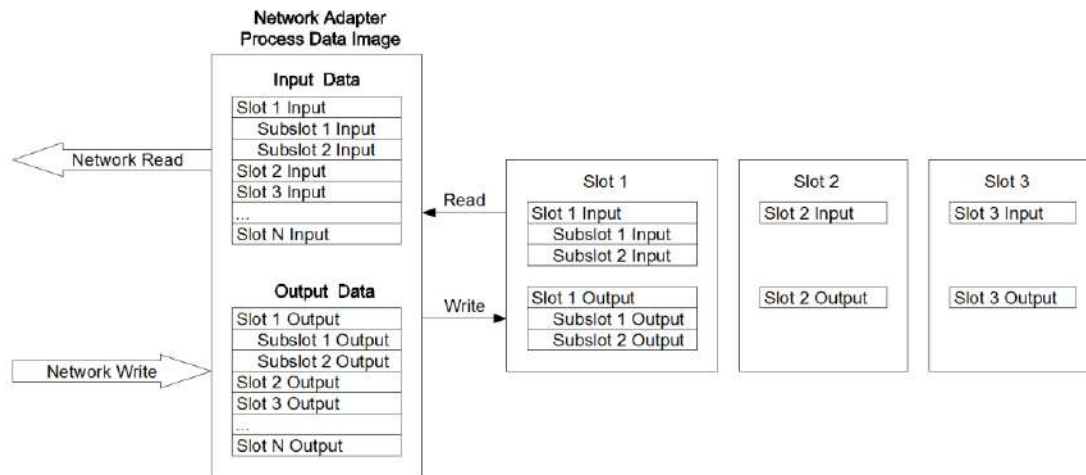

Real-time data exchange is conducted between the network adapter and the extended IO module, and the data address table could be dynamically allocated according to the different modules inserted in the IO slot.

The actual mapping address should be added IO module manually in STEP 7, TIA or other configured software, and the address would be automatically mapped, so the actual mapping address could be checked.

6 Configuration Parameter Definition

Configuration Parameter								
Bit No	Bit 7	Bit 6	Bit 5	Bit 4	Bit 3	Bit 2	Bit 1	Bit 0
Byte 0						Fault Action for Output	Fault Action for Input	Source of Configuration Data
Byte 1	DP Address							

Data description:

Source of Config Data: Parameter configuration mode (Default: 1, Field BUS configuration)

- 0: Configured software configuration
- 1: Field BUS configuration

Fault Action for Input: Input fault handling mode, when IO module is offline, the adapter will process IO module input data according to this mode. (Default: 0, Hold Last Input Value)

- 0: Hold Last Input Value
- 1: Clear Input Value

Fault Action for Output: Output fault handling mode, when the IO module is offline, the adapter will process the IO module output data according to this mode. (Default: 1, Clearing Output Value)

- 0: Hold Last Output Value
- 1: Clearing Output Value

DP Address: DP slave device no. (Read-only, displayed as the value of the dial code switch)

A Dimension drawing

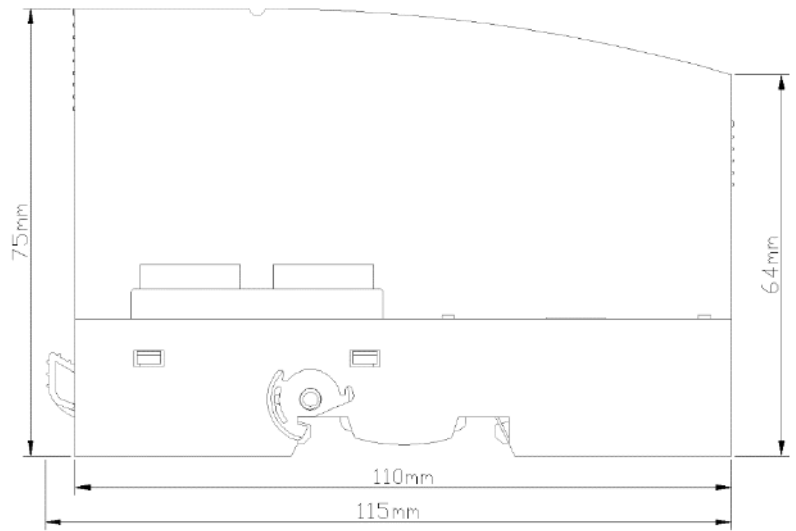
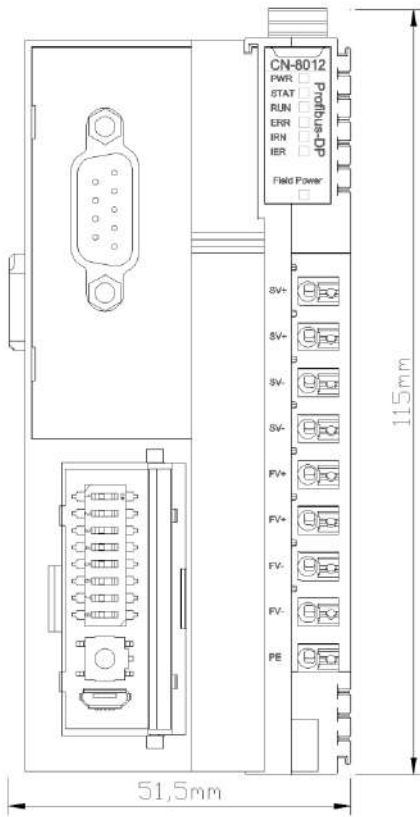

CN-8013 CC-Link Bus Adapter

1 Module Overview

CN-8013 CC-Link bus adapter supports standard CC-Link Ver.2 communication and it could monitor the communication status of IO modules in real time.

2 Technical Parameter

Hardware Parameter	
System Power	Nominal:24VDC, Range: 20-30VDC Protection: Reverse Protection, Overcurrent Protection
Power Consumption	110mA@24VDC
Internal Bus Supply Current	Max: 2.0A@5VDC
Isolation	System Power to Field Power Isolation
Power Supply	Nominal:24VDC, Range:20.4-28.8VDC
Field Power Current	Max. DC 8A
IO Modules Supported	32pcs
Wiring	Max.: AWG 18 Min.: AWG 24
Installation	35mm DIN-Rail
Size	115*51.5*75mm
Weight	130g
Environment Specification	
Operating Temperature of Horizontal Installation	-35°C~70°C
Operating Temperature of Vertical Installation	-35°C~60°C
Relative Humidity	< 95%RH (No Condensation)
Storage Temperature	-40°C~85°C
Storage Humidity	< 95%RH (No Condensation)
Manufacturing Test Temperature	-40°C~75°C
Ingress Protection Rating	IP20
CC-Link Parameter	
Protocol	CC-Link Ver.2
Station Type	Remote device station
Number of Logical Stations Occupied	1, 2, 3, 4
Extended Loop Setup	1 time, 2 times, 4 times, 8 times
I/O Data Capacity	RX/RX capacity (bit) max. 896 RWr/RWw capacity (word) max. 128
Baud Rate	156K/625K/2.5M/5M/10Mbps
Node Station (Station No.)	1~64(DIP switch configuration), when DIP switch value is not 1~64, and the mandatory station number is forced to 1.
Interface	5 Pin screw terminal
Max. bus length	1200m (156kbps)
Terminal resistance	120Ω

  **DANGER**

THERE IS A RISK OF ELECTRIC SHOCK, EXPLOSION, OR ARC FLASH.

Disconnect all devices from power, including connected devices, before removing any covers, or installing or removing any accessories, hardware, cables, or wires, except in specific circumstances specified in the appropriate hardware guidelines for this device.

Always use a voltage sensing device with an appropriate rating to detect a power outage at the appropriate place and time, as instructed.

Replace and tighten all covers, accessories, hardware, cables, and wires, and confirm that the ground connection is correct before powering on the device.

When operating this equipment and related products, the specified voltage must be used.

Failure to follow instructions specified by the manufacturer may result in serious consequences such as death, personal injury, or damage to equipment since the protection provided by the equipment may be impaired.

3 Hardware Interface

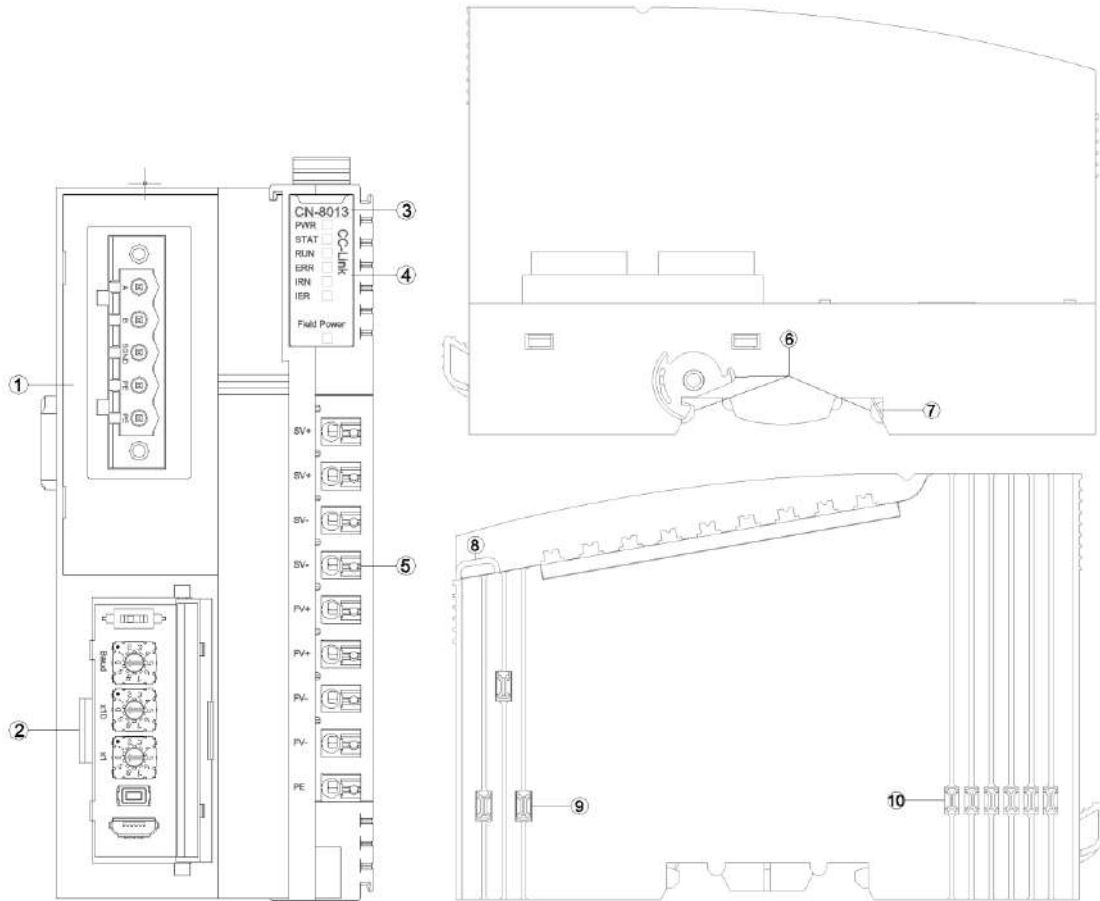

- ① CC-Link port
- ② Config Interface
- ③ Module type
- ④ LED Indicator
- ⑤ Wiring Terminal
- ⑥ Buckle
- ⑦ Grounding Spring Sheet
- ⑧ Fixed Wiring Harness
- ⑨ Field Power
- ⑩ Internal Bus

3.1 CC-Link Interface

Modbus RS485 port is 5 Pin screw terminals and its Pin definition is as below:

Pin	Definition	Description
1	DA	Signal DA
2	DB	Signal DB
3	DG	Signal Grounded
4	SLD	Earthing of Shield
5	FG	Protect Earthing

3.2 Configuration Interface

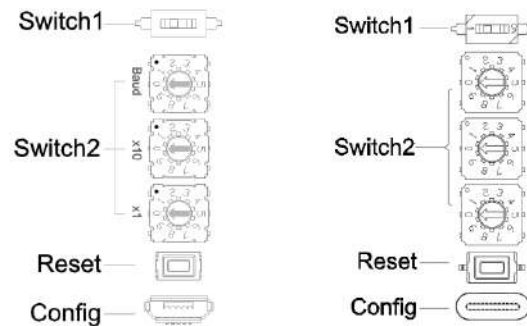

Switch1: DIP switch is used to set the terminal resistance.

Switch2: DIP switch is used to set the adapter module node address (station number) and baud rate.

The node address is set by two hardware DIP switches of decimal number, and each CC-Link adapter has a unique node address (1~64). (Please note: when the DIP switch value is not 1~64, the node address in the station number is forced to 1.)

The corresponding relation between baud rate and dial code is:

Code configuration	Communication Rate (bps)
0	156k
1	625k
2	2.5M
3	5M
4	10M

Reset: Module reset button, long pressing the button for more than 5 seconds and all parameters of the module will be restored to the default value. When the Reset button is activated, a green indicator will light up in the upper left corner of the button.

Config: configured ports, it is standard Micro USB/Type-C interface for configuring device parameters and firmware upgrades.

3.3 LED Indicator

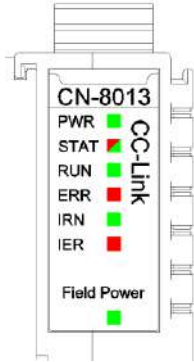

PWR Power State (GREEN)	Definition
ON	System Power Normal
OFF	System Power Failure
STAT Module State (RED/GREEN)	Definition
Double Flash (RED)	Module Soft Restarted by Hard-Fault
ON(GREEN)	Running
Single Flash (GREEN)	Stopping
Flash(2.5Hz) (RED/GREEN)	Boot Mode
Flash(10Hz) (RED/GREEN)	Firmware Updating
RUN Network State (GREEN)	Definition
OFF	No data exchanging.
ON	CC-Link data exchanging
ERR Network Error (RED)	Definition
OFF	CC-Link data exchanging normal
ON	CC-Link data exchanging failure
Flash	When CC-Link communication normally functiones, the station number or baud rate will get changed
IRN IO Run (GREEN)	Definition
ON	IO Initialization Normal
OFF	IO Initialization Failure
IER IO Error (RED)	Definition
OFF	IO Communication Normal
Double Flash	IO Communication Failure
Field Power State (GREEN)	Definition
ON	Field Power Normal
OFF	Field Power Failure

WARNING

UNEXPECTED EQUIPMENT OPERATION

By viewing the PW indicator, could determine the power supply status of a module. If the PW is steady green, the power supply is normal. Otherwise, the module cannot work properly.

When the module is initially powered on, there will be 3S for the backplane bus connection. After the backplane bus is initialized, STA is in the green steady state. If STA is in the green blinking state, it indicates that the backplane bus has not been initialized, and it needs to be powered off and restarted for re-initialization.

STA abnormal working state occurs during the normal operation of the module, please check the firmware version information of all modules, and consult ODOT technical support for details.

If a module is upgraded, check that all modules are in the normal state after the upgrade. Otherwise, an exception may occur.

Failure to follow instructions specified by the manufacturer may result in serious consequences such as death, personal injury, or damage to equipment since the protection provided by the equipment may be impaired.

AVERTISSEMENT

FONCTIONNEMENT INATTENDU DE L'EQUIPEMENT

En regardant l'état de l'indicateur de PW, jugez l'état d'alimentation du module. Le feu vert PW reste allumé et l'alimentation est normale. Autrement, le module ne fonctionnera pas correctement.

Lorsque le module est alimenté initialement, il y aura 3S pour la connexion de bus de backboard. STA est un état vert permanent après l'initialisation du bus de backboard. Si STA est en état de clignotement vert, cela signifie que l'initialisation du bus de backboard n'est pas passée et doit être redémarrée hors tension et réinitialisée.

L'état de fonctionnement anormal de STA se produit pendant le fonctionnement normal du module, veuillez vérifier les informations de version du firmware de tous les modules, et consulter le support technique ODOT pour plus de détails.

Si le module a une opération de mise à niveau, après l'achèvement de la mise à niveau, le besoin de vérifier que tous les modules sont dans l'état normal avant de courir, sinon il conduira à une exception.

Le fait de ne pas suivre les instructions peut entraîner une défaillance de la protection fournie par l'équipement, ce qui peut entraîner des conséquences graves, comme des blessures ou des dommages à l'équipement.

4 Wiring

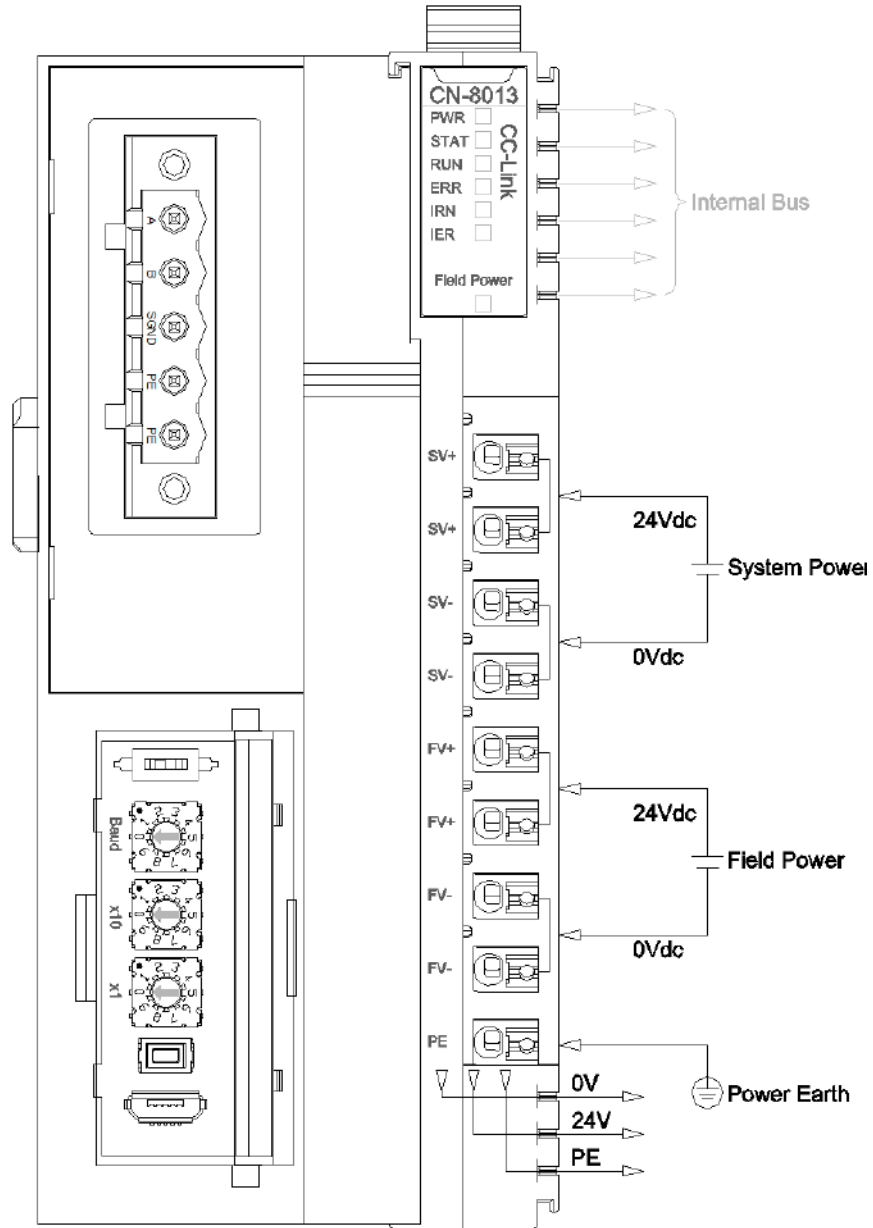

NOTICE

UNEXPECTED DEVICE OPERATION

Inside the module, two terminal blocks SV+ have been shorted, two terminal blocks SV - have been shorted, two terminal blocks FV+ have been shorted, and two terminal blocks FV - have been shorted. Externally, only one system power supply and one field power supply need to be connected.

The wire should be copper wire with a core greater than 0.2mm^2 and less than 1mm^2 , and the impedance is less than 10Ω .

Failure to follow instructions specified by the manufacturer may result in serious consequences such as death, personal injury, or damage to equipment since the protection provided by the equipment may be impaired.

5 Process data definition

5.1 Adapter process data definition

CC-Link Adapter itself has no input-output process data.

5.2 IO Module process data mapping

The network adapter reads and writes input and output process data of IO module in real time through the internal bus, and its data mapping model is shown as follow:

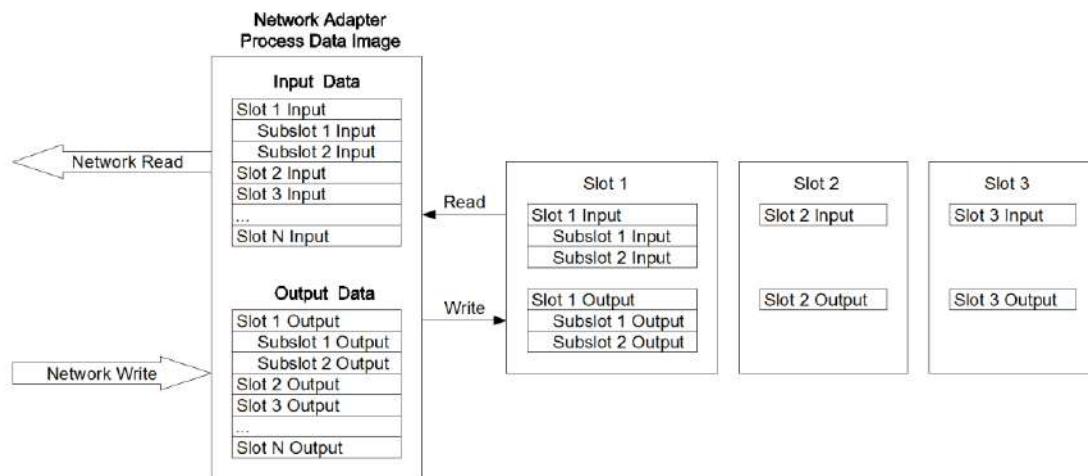

6 Configuration Parameter Definition

Configuration Parameter									
Bit No	Bit 7	Bit 6	Bit 5	Bit 4	Bit 3	Bit 2	Bit 1	Bit 0	
Byte 0						Fault Action for Output	Fault Action for Input	Source of Configuration Data	
Byte 1	Slave ID								
Byte 2	BaudRate								
Byte 3	Occupied Stations								
Byte 4	Extesion Cycles								
Byte 5	Auto Stations/Cycles								
Byte 6	RX/RX Size(Bits)								
Byte 7									
Byte 8	RWr/RWw Size(words)								
Byte 9									

Data description:

Source of Configuration Data: Parameter configuration mode (Default: 0)

0: Configuration Software

Fault Action for Input: Input fault handling mode, when IO module is offline, the adapter will process IO module input data according to this mode. (Default: 0, Hold Last Input Value)

0: Hold Last Input Value

1: Clear Input Value

Fault Action for Output: Output fault handling mode, when the IO module is offline, the adapter will process the IO module output data according to this mode. (Default: 1, Clearing Output Value)

0: Hold Last Output Value

1: Clearing Output Value

Slave ID: CC-Link slave ID number, hardware DIP switch setting, 1-64

Baud Rate: Serial port baud rate, (Default: 0, 156bps))

0: 156Kbps

1: 625Kbps

2: 2.5Mbps

3: 5Mbps

4: 10Mbps

Occupied Stations: The number of logical stations occupied (Default: 3, 4 stations)

0: 1 station

1: 2 stations

2: 3 stations

3: 4 stations

Extesion Cycles: Extended loop setup (Default: 3, 8 Times)

0: 1 Time

1: 2 Times

2: 4 Times

3: 8 Times

Auto Stations/Cycles: Automatic counting station number and extension cycle, disable, cycle optional. (Default: 0, disabled)

0: disabled

1: enabled

RX/RY Size(Bits): RX/RY Capacity (Bits)

RWr/RWw Size(words): RWr/RWw Capacity (Word)

A Dimension drawing

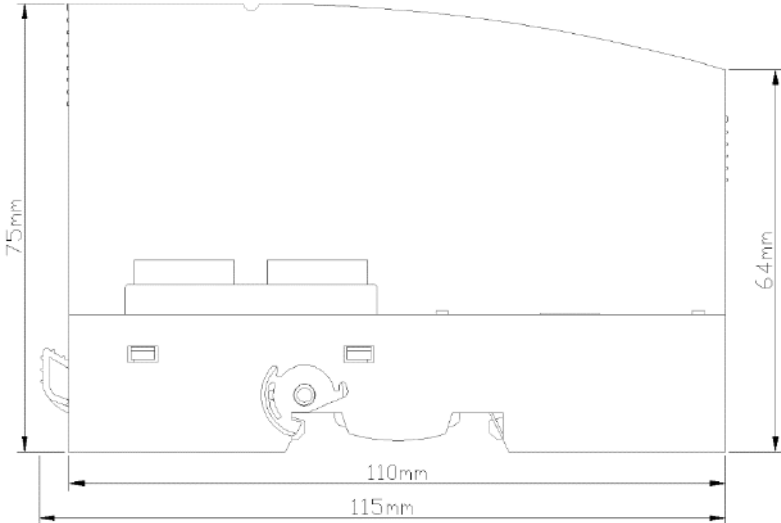
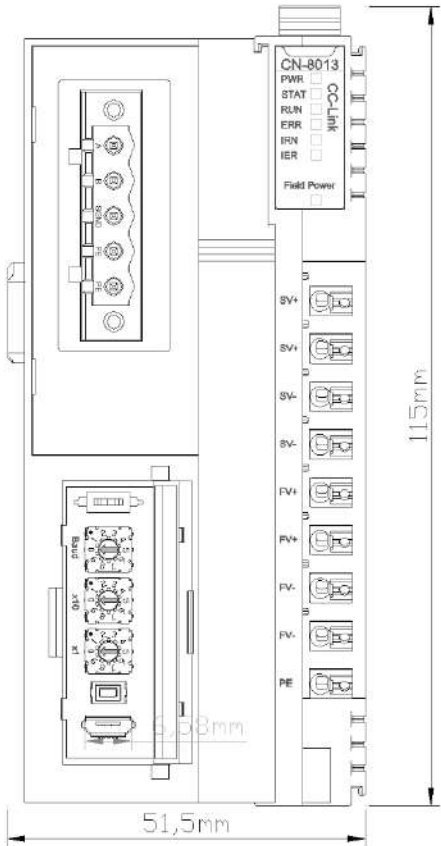

CN-8021 CANopen Bus Adapter

1 Module Overview

CN-8021 CANopen bus adapter supports standard CANopen communication and device specification DS401.

2 Technical Parameter

Hardware Parameter	
System Power	Nominal:24VDC, Range: 20-30VDC Current: Max.2A@24VDC Reverse Protection: YES
Power Consumption	50mA@24VDC
Internal Bus Supply Current	Max.: 2.5A@5VDC
Isolation	System Power to Field Power Isolation
Power Supply	Nominal:24VDC, Range:20.4-28.8VDC
Field Power Current	Max. DC 8A
IO Modules Supported	32 pcs
Wiring	Max.: AWG 18 Min.: AWG 24
Installation	35mm DIN-Rail
Size	115*51.5*75mm
Weight	130g
Environment Specification	
Operating Temperature of Horizontal Installation	-35°C~70°C
Operating Temperature of Vertical Installation	-35°C~60°C
Relative Humidity	< 95%RH (No Condensation)
Storage Temperature	-40°C~85°C
Storage Humidity	< 95%RH (No Condensation)
Manufacturing Test Temperature	-40°C~75°C
Ingress Protection Rating	IP20
CANOPEN Parameter	
Protocol	CANopen DS401
Connect the interface	5PIN terminal
Station Address	Dial code setting (1-99)
Process Data	Input Max. 512 Byte Output Max. 512 Byte
Configuration Interface	Type-C
Transmission Rate	10 kbit/s, 20 kbit/s, 50 kbit/s, 100 kbit/s, 125 kbit/s, 250 kbit/s, 500 kbit/s, 800 kbit/s,1000 kbit/s

 **DANGER**

THERE IS A RISK OF ELECTRIC SHOCK, EXPLOSION, OR ARC FLASH.

Disconnect all devices from power, including connected devices, before removing any covers, or installing or removing any accessories, hardware, cables, or wires, except in specific circumstances specified in the appropriate hardware guidelines for this device.

Always use a voltage sensing device with an appropriate rating to detect a power outage at the appropriate place and time, as instructed.

Replace and tighten all covers, accessories, hardware, cables, and wires, and confirm that the ground connection is correct before powering on the device.

When operating this equipment and related products, the specified voltage must be used.

Failure to follow instructions specified by the manufacturer may result in serious consequences such as death, personal injury, or damage to equipment since the protection provided by the equipment may be impaired.

3 Hardware Interface

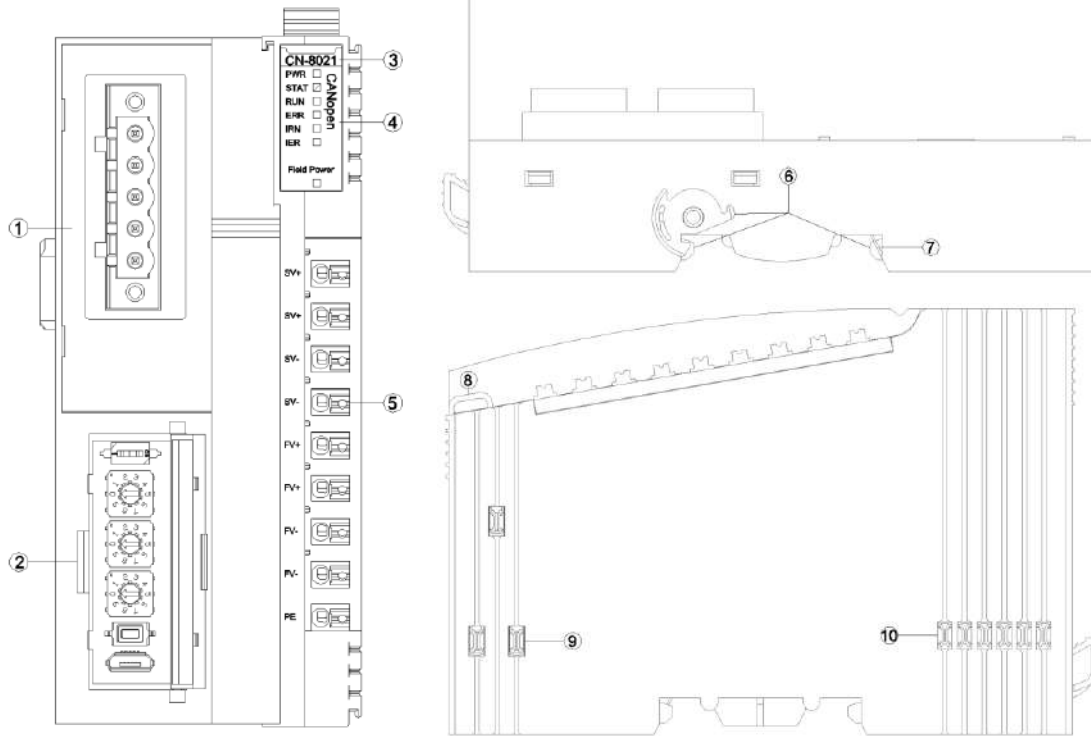

- ① CANopen port
- ② Config Interface
- ③ Module type
- ④ LED Indicator
- ⑤ Wiring Terminal
- ⑥ Buckle
- ⑦ Grounding Spring Sheet
- ⑧ Fixed Wiring Harness
- ⑨ Field Power
- ⑩ Internal Bus

3.1 CANopen Interface

The device wiring adapts 5 Pin screw terminals and its Pin definition is as below:

CANopen interface pin definition

Pin	Definition	Description
1	NC	Empty
2	CANH	CAN_H signal bus line
3	PE	Protecting Earthing
4	CANL	CAN_L signal terminal bus line
5	GND	Signal Grounded

3.2 Configuration Interface

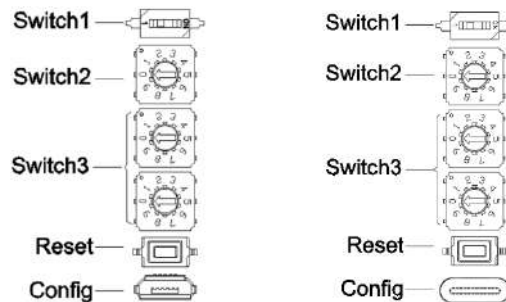

Switch1: DIP switch is used to set the terminal resistance.

Switch2: DIP switch is used to set the communication baud rate

Switch3: DIP switch is used to set the address of the adapter module. It is set by a 2-bit decimal hardware DIP switch, and each CANopen adapter has a unique station address (1~99).

Reset: Module reset button, long pressing the button for more than 5 seconds and all parameters of the module will be restored to the default value. When the Reset button is activated, a green indicator will light up in the upper left corner of the button.

Config: configured ports, it is standard Micro USB/Type-C interface for configuring device parameters and firmware upgrades.

3.4 LED Indicator

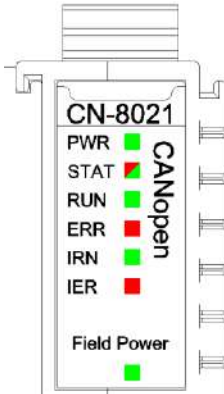

PWR Power State (GREEN)	Definition
ON	System Power Normal
OFF	System Power Failure
STAT Module State (RED/GREEN)	Definition
Double Flash (RED)	Module Soft Restarted by Hard-Fault
ON(GREEN)	Running
Single Flash (GREEN)	Stopping
Flash(2.5Hz) (RED/GREEN)	Boot Mode
Flash(10Hz) (RED/GREEN)	Firmware Updating
RUN Network State (GREEN)	Definition
ON	CAN communication has been established
Flash	The CAN communication is not established
ERR Network Error (RED)	Definition
OFF	No Error
Flash	Error Existing
IRN IO Run Indicator (GREEN)	Definition
ON	IO Initialization Normal
OFF	IO Initialization Failure
IER IO Error Indicator (RED)	Definition
OFF	IO Communication Normal
Double Flash	IO Communication Failure
Field Power State Indicator (GREEN)	Definition
ON	Field Power Normal
OFF	Field Power Failure

WARNING

UNEXPECTED EQUIPMENT OPERATION

By viewing the PW indicator, could determine the power supply status of a module. If the PW is steady green, the power supply is normal. Otherwise, the module cannot work properly.

When the module is initially powered on, there will be 3S for the backplane bus connection. After the backplane bus is initialized, STA is in the green steady state. If STA is in the green blinking state, it indicates that the backplane bus has not been initialized, and it needs to be powered off and restarted for re-initialization.

STA abnormal working state occurs during the normal operation of the module, please check the firmware version information of all modules, and consult ODOT technical support for details.

If a module is upgraded, check that all modules are in the normal state after the upgrade. Otherwise, an exception may occur.

Failure to follow instructions specified by the manufacturer may result in serious consequences such as death, personal injury, or damage to equipment since the protection provided by the equipment may be impaired.

AVERTISSEMENT

FONCTIONNEMENT INATTENDU DE L'EQUIPEMENT

En regardant l'état de l'indicateur de PW, jugez l'état d'alimentation du module. Le feu vert PW reste allumé et l'alimentation est normale. Autrement, le module ne fonctionnera pas correctement.

Lorsque le module est alimenté initialement, il y aura 3S pour la connexion de bus de backboard. STA est un état vert permanent après l'initialisation du bus de backboard. Si STA est en état de clignotement vert, cela signifie que l'initialisation du bus de backboard n'est pas passée et doit être redémarrée hors tension et réinitialisée.

L'état de fonctionnement anormal de STA se produit pendant le fonctionnement normal du module, veuillez vérifier les informations de version du firmware de tous les modules, et consulter le support technique ODOT pour plus de détails.

Si le module a une opération de mise à niveau, après l'achèvement de la mise à niveau, le besoin de vérifier que tous les modules sont dans l'état normal avant de courir, sinon il conduira à une exception.

Le fait de ne pas suivre les instructions peut entraîner une défaillance de la protection fournie par l'équipement, ce qui peut entraîner des conséquences graves, comme des blessures ou des dommages à l'équipement.

4 Wiring

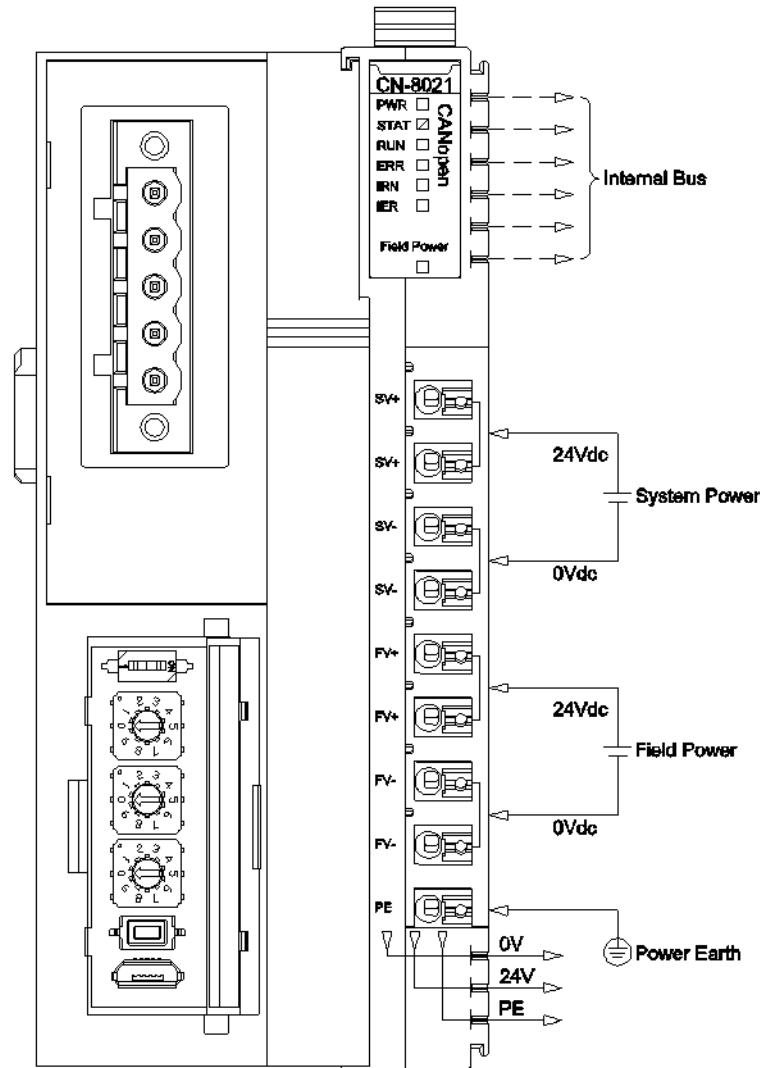

NOTICE

UNEXPECTED DEVICE OPERATION

Inside the module, two terminal blocks SV+ have been shorted, two terminal blocks SV - have been shorted, two terminal blocks FV+ have been shorted, and two terminal blocks FV - have been shorted. Externally, only one system power supply and one field power supply need to be connected.

The wire should be copper wire with a core greater than 0.2mm² and less than 1mm², and the impedance is less than 10Ω.

Failure to follow instructions specified by the manufacturer may result in serious consequences such as death, personal injury, or damage to equipment since the protection provided by the equipment may be impaired.

5 Process data definition

5.1 Adapter process data definition

CANopen Adapter itself has no input-output process data.

5.2 IO Module process data mapping

The network adapter reads and writes input and output process data of IO module in real time through the internal bus, and its data mapping model is shown as follow:

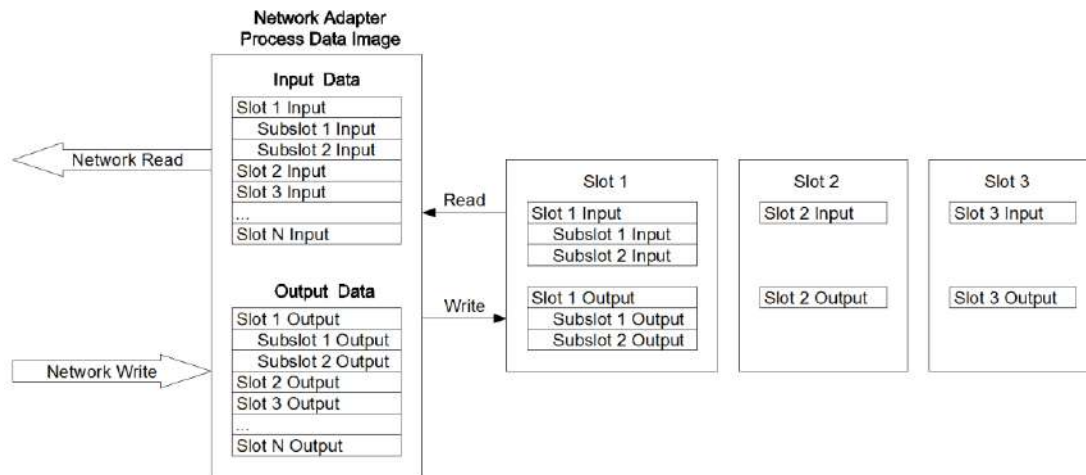

Input and output data of the IO module are mapped to objects 6000,6200, 6401,6411 based on data types. TPDO and RPDO both support variable PDO mapping.

6 Configuration Parameter Definition

Configuration Parameter				
No.	Description			
Byte 0	Reserved	Fault Action for Output	Fault Action for Input	Source of Configuration Data
Byte 1	CAN BaudRate			
Byte 2	CANopen Slave Address			
Byte 3	Reserved		Auto Start	Auto Generate PDO COB-ID
Byte 4				
Byte 5 ... Byte 19	Reserved			

Data description:

Source of Configuration Data: Parameter configuration mode (Default: 0)

0: Configured software configuration is valid

1: Fieldbus controller configuration is valid

Fault Action for Input: Input data handling mode when IO occurs fault (Default: 0)

0: Hold Last Input Value

1: Clear Input Value

Fault Action for Output: Output data handling mode when IO occurs fault (Default: 1)

0: Hold Last Output Value

1: Clear Output Value

CANopen Slave Address: CANopen slave device number (read only, default: 1)

CAN BaudRate: CAN bus baud rate Settings (default: 2)

0: 1 MBit/sec

1: 800 kBit/sec

2: 500 kBit/sec

3: 250 kBit/sec

4: 125 kBit/sec

5: 100 kBit/sec

6: 50 kBit/sec

7: 20 kBit/sec

8: 10 kBit/sec

Auto Generate PDO COB-ID: PDO identifiers can be automatically assigned, the Enable and the Disable is optional. After the PDO identifier is enabled, the PDO identifier could be automatically assigned to the I/O module. After the PDO identifier is disabled, only 4 predefined PDO are available, and more PDO need to be set by the CANOPEN master. It is disabled by default.

Auto Start: The slave is automatically started. Enable and disable is optional. After this function is enabled, the site will proactively send a PDO message and uploads the message when there is data. It is disabled by default.

A Dimension drawing

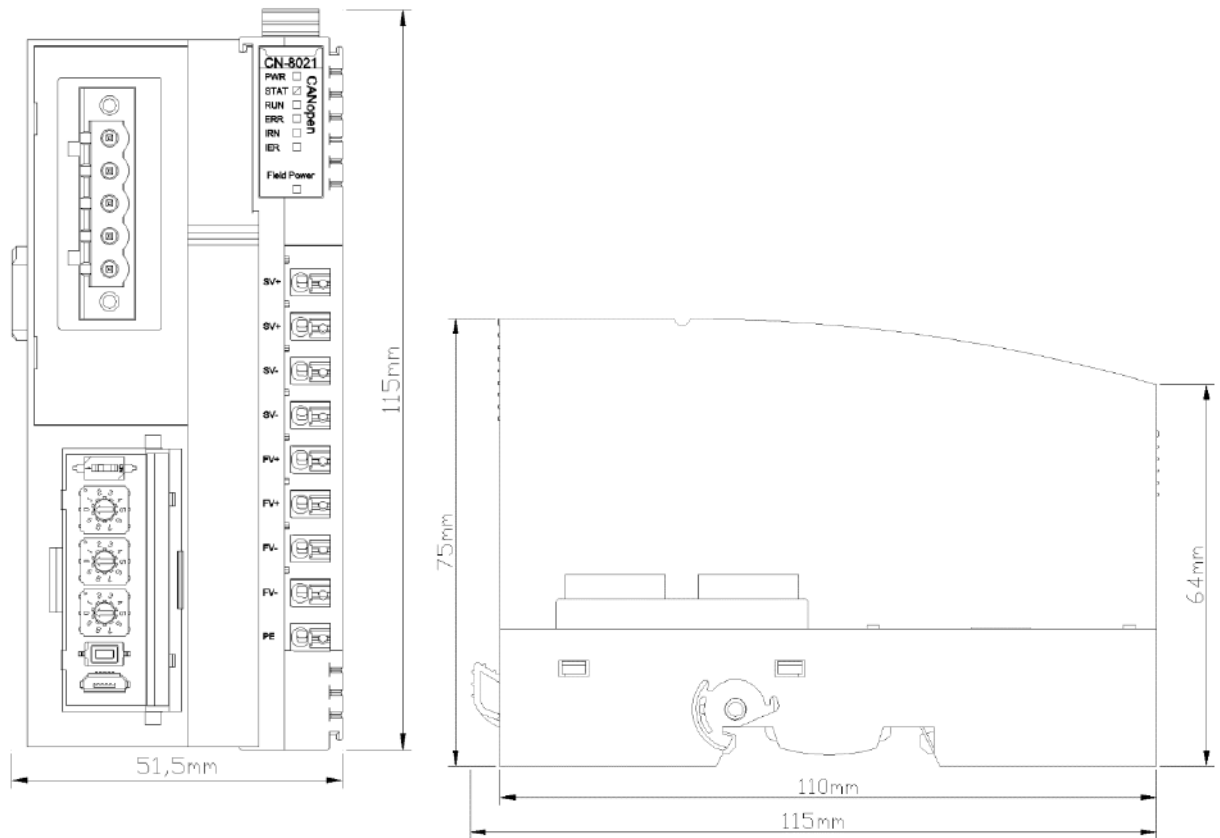

CN-8022 DeviceNet Bus Adapter

1 Module Overview

CN-8022 DeviceNet module supports access of DeviceNet protocol, the adapter supports a maximum input of 512 bytes, a maximum output of 512 bytes, and the number of the extended IO modules it supports is 32.

2 Technical Parameter

General Parameter	
System Power	Supply: 20~30VDC (Nominal: 24VDC) Current: Max.2A@24VDC Protection: Overcurrent Protection, Reverse Protection
Power Consumption	50mA@24VDC
Internal BUS Supply Current	Max: 2.5A@5VDC
Isolation	System power to Field power: Isolation The isolation voltage between system power and field power: AC 500V The isolation voltage between filed power and PE: AC 500V The isolation voltage between system power and PE: AC 500V
Field Power	Supply: 20.4~28.8VDC (Nominal: 24VDC) Protection: Reverse protection
Filed Power Current	Max. DC 8A
IO Modules Supported	32
Wiring	Max.: AWG 18 Min.: AWG 24
Installation	35mm DIN-Rail
Size	115*51.5*75mm
Weight	130g
Environment Parameter	
Operating Temperature	-35°C~70°C
Ambient Humidity	5%~95% No Condensation
Ingress Protection Rating	IP20
DeviceNet Parameter	
Protocol	DeviceNet
Station Type	Remote equipment station
Node Address (station number)	Dial code setting (1-63), If the dial code value is not 1-63, the station number is forced to be 1
I/O Data Size	Maximum input: 512Byte Maximum output: 512Byte
Transmission Rate	Dial code setting (125kbit/s, 250kbit/s, 500kbit/s)
Connection Interface	5PIN Terminal
Maximum Transmission Rate	125kbit/s—500m;250kbit/s—250m;500kbit/s—100m
EMC Parameter	
Static	Contact: 6KV Air: 8KV

 **DANGER**

THERE IS A RISK OF ELECTRIC SHOCK, EXPLOSION, OR ARC FLASH.

Disconnect all devices from power, including connected devices, before removing any covers, or installing or removing any accessories, hardware, cables, or wires, except in specific circumstances specified in the appropriate hardware guidelines for this device.

Always use a voltage sensing device with an appropriate rating to detect a power outage at the appropriate place and time, as instructed.

Replace and tighten all covers, accessories, hardware, cables, and wires, and confirm that the ground connection is correct before powering on the device.

When operating this equipment and related products, the specified voltage must be used.

Failure to follow instructions specified by the manufacturer may result in serious consequences such as death, personal injury, or damage to equipment since the protection provided by the equipment may be impaired.

3 Hardware Interface

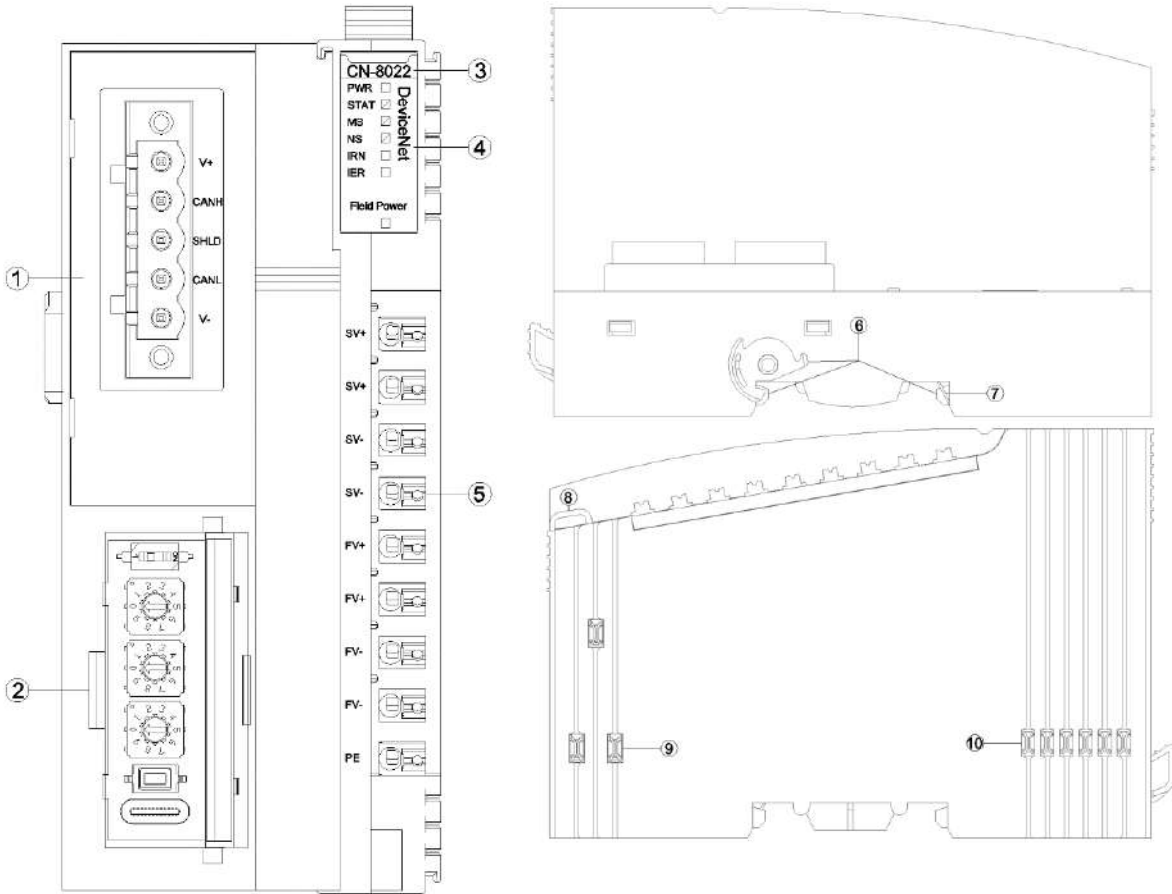

- ② Communication Configuration Interface
- ③ Module Type
- ④ LED Indicator
- ⑤ Wiring Terminal
- ⑥ Buckle
- ⑦ Grounding Spring Sheet
- ⑧ Fixed Wiring Harness
- ⑨ Field Power
- ⑩ Internal Bus

3.1 DeviceNet Interface

The wiring of the equipment adopts 5PIN terminals, and the terminal definition is as below:

DeviceNet interface pin definition:

Pin	Definition	Description
1	V+	24V+
2	CANH	CAN_H Signal line
3	SHLD	Shielded ground
4	CANL	CAN_L Signal line
5	V-	24V-

3.2 Configuration Interface

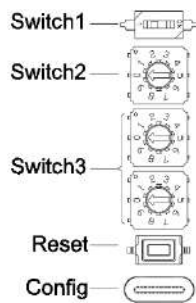

Switch1: The DIP switch is used to set the terminal resistance.

Switch2: The DIP switch is used to set the communication baud rate

Switch3: The DIP switch is used to set the adapter node address. The node is set by a 2-digit decimal hardware DIP switch, each DeviceNet adapter has a unique station address (1~63).**(Special note: When the dial value is not 1~63, the node address (station number) is forced to be 1.)**

The correspondence between baud rate and DIP code is:

DIP settings	Communication rate(bps)
0	125k
1	250k
2	500k

Reset: Module reset button, long pressing the button for more than 5 seconds and all parameters of the module will be restored to the default value. When the Reset button is activated, a green indicator will light up in the upper left corner of the button.

Config: Configuration port, standard Type-C interface, used to configure device parameters and firmware upgrade.

 **WARNING**

OUT OF CONTROL

If the DIP Switch value is not 0, the DIP switch address value is the station address of the module. If the PLC communicates by assigning station address, there is a conflict between the allocated address and the DIP address. After power failure and restart, the DIP value address has a high priority, resulting in abnormal communication and module loss of control.

Failure to follow instructions specified by the manufacturer may result in serious consequences such as death, personal injury, or damage to equipment since the protection provided by the equipment may be impaired.

 **AVERTISSEMENT**

PERTE DE CONTROLE

Si la valeur du commutateur DIP n'est pas 0, la valeur de l'adresse du commutateur DIP est l'adresse de la station du module. Si le PLC communique en assignant l'adresse de la station, il y a un conflit entre l'adresse allouée et l'adresse DIP. Après une panne de courant et un redémarrage, l'adresse de valeur DIP a une priorité élevée, ce qui entraîne une communication anormale et une perte de contrôle du module.

Le fait de ne pas suivre les instructions peut entraîner une défaillance de la protection fournie par l'équipement, ce qui peut entraîner des conséquences graves, comme des blessures ou des dommages à l'équipement.

3.3 LED Indicator

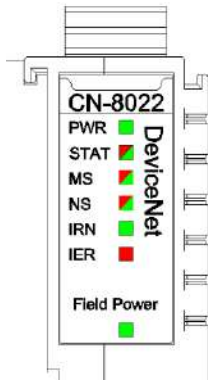

PWR Power Indicator (GREEN)	Definition
ON	System Power Normal
OFF	System Power Failure
STAT Module State Indicator (RED/GREEN)	Definition
Double Flash (RED)	Module Soft Restarted by Hard-Fault
ON(GREEN)	Running
Single Flash (GREEN)	Stopping
Flash(2.5Hz) (RED/GREEN)	Boot Mode
Flash(10Hz) (RED/GREEN)	Firmware Updating
MS Slave Status Indicator (RED/GREEN)	Definition
ON(GREEN)	The module is running correctly
Flash (GREEN)	Baud rate detection
ON(RED)	Critical link failure
Flash (RED)	The connection timed out
Flash (RED/GREEN)	Conducting a self-test
OFF	The module is powered off
NS Network Status Indicator (RED/GREEN)	Definition
ON(GREEN)	Online, 1 or more connections are established
Flash (GREEN)	Online, no connection established
ON(RED)	Critical link failure
Flash (RED)	The connection timed out
Flash (RED/GREEN)	Conducting a self-test
OFF	The module is powered off or offline
IRN IO Running Indicator (GREEN)	Definition
ON	IO Initialization Normal
OFF	IO Initialization Failure
IER IO Error Indicator (RED)	Definition
OFF	IO Communication Normal
Double Flash	IO Communication Failure
Field Power Light (GREEN)	Definition
ON	Field Power Normal

OFF	Field Power Failure
-----	---------------------

WARNING

UNEXPECTED EQUIPMENT OPERATION

By viewing the PW indicator, could determine the power supply status of a module. If the PW is steady green, the power supply is normal. Otherwise, the module cannot work properly.

When the module is initially powered on, there will be 3S for the backplane bus connection. After the backplane bus is initialized, STA is in the green steady state. If STA is in the green blinking state, it indicates that the backplane bus has not been initialized, and it needs to be powered off and restarted for re-initialization.

STA abnormal working state occurs during the normal operation of the module, please check the firmware version information of all modules, and consult ODOT technical support for details.

If a module is upgraded, check that all modules are in the normal state after the upgrade. Otherwise, an exception may occur.

Failure to follow instructions specified by the manufacturer may result in serious consequences such as death, personal injury, or damage to equipment since the protection provided by the equipment may be impaired.

AVERTISSEMENT

FONCTIONNEMENT INATTENDU DE L'EQUIPEMENT

En regardant l'état de l'indicateur de PW, jugez l'état d'alimentation du module. Le feu vert PW reste allumé et l'alimentation est normale. Autrement, le module ne fonctionnera pas correctement.

Lorsque le module est alimenté initialement, il y aura 3S pour la connexion de bus de backboard. STA est un état vert permanent après l'initialisation du bus de backboard. Si STA est en état de clignotement vert, cela signifie que l'initialisation du bus de backboard n'est pas passée et doit être redémarrée hors tension et réinitialisée.

L'état de fonctionnement anormal de STA se produit pendant le fonctionnement normal du module, veuillez vérifier les informations de version du firmware de tous les modules, et consulter le support technique ODOT pour plus de détails.

Si le module a une opération de mise à niveau, après l'achèvement de la mise à niveau, le besoin de vérifier que tous les modules sont dans l'état normal avant de courir, sinon il conduira à une exception.

Le fait de ne pas suivre les instructions peut entraîner une défaillance de la protection fournie par l'équipement, ce qui peut entraîner des conséquences graves, comme des blessures ou des dommages à l'équipement.

4 Wiring

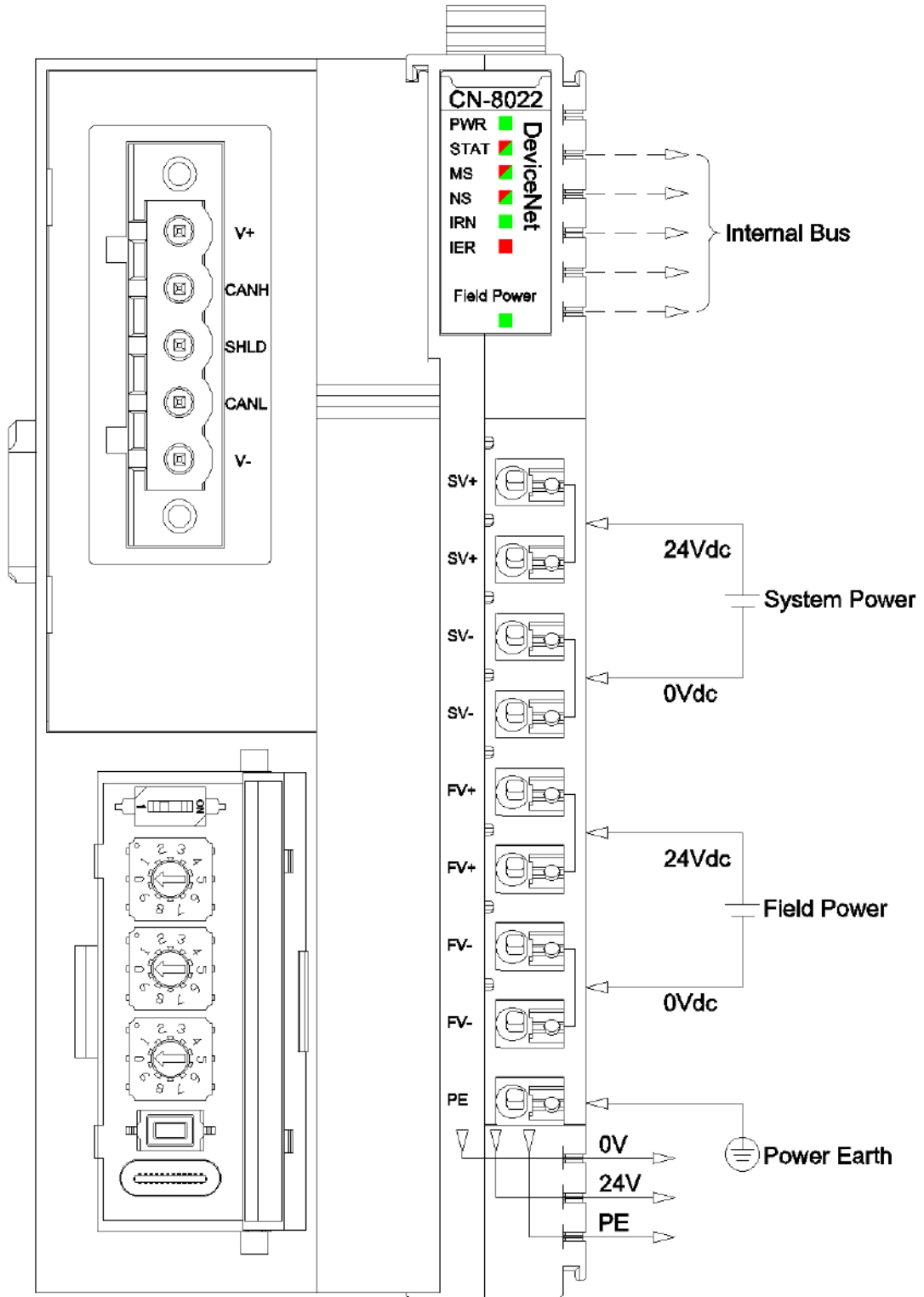

NOTICE

UNEXPECTED DEVICE OPERATION

Inside the module, two terminal blocks SV+ have been shorted, two terminal blocks SV - have been shorted, two terminal blocks FV+ have been shorted, and two terminal blocks FV - have been shorted. Externally, only one system power supply and one field power supply need to be connected.

The wire should be copper wire with a core greater than 0.2mm^2 and less than 1mm^2 , and the impedance is less than 10Ω .

Failure to follow instructions specified by the manufacturer may result in serious consequences such as death, personal injury, or damage to equipment since the protection provided by the equipment may be impaired.

5 Process Data Definitions

Communication Board Process Data Definition

Input Data				
Bit No	Bit 15~Bit 3	Bit 2	Bit 1	Bit 0
Word 0	Reserved	Slave I/O output data capacity overrun detection	Slave IO input data capacity overrun detection	Slave startup status
Word 1	Reserved			
Word 2	Reserved			
Word 3	Reserved			
Output Data				
Bit No	Bit 15~Bit 0			
Word 0	Reserved			
Word 1	Reserved			
Word 2	Reserved			
Word 3	Reserved			

Data Description:

Slave Startup Status: Detect whether the slave starts normally, the corresponding slave does not start successfully, the bit value is 1, and the value of the slave is 0 when the slave is not started successfully.

0: The slave starts normally

1: The slave starts abnormally

Slave IO input data capacity overrun detection: Detect the total number of bytes of input data for module configuration, if the number is over 512 bytes, this bit is forced to 1, otherwise this bit is forced to 0.

0: The total length of the input data does not exceed 512 bytes

1: The total length of input data is more than 512 bytes

Slave IO output data capacity overrun detection: Detect the total number of bytes of input data for module configuration, if the number is over 512 bytes, this bit is forced to 1, otherwise this bit is forced to 0.

0: The total length of the output data does not exceed 512 bytes

1: The total length of the output data is more than 512 bytes

6 Configuration Parameter Definitions

Configuration parameter									
Bit No	Bit 7	Bit 6	Bit 5	Bit 4	Bit 3	Bit 2	Bit 1	Bit 0	
Byte 0	Reserved					Fault ACTION for Output	Fault ACTION for Input	Source of Config Data	
Byte 1	Slave ID								
Byte 2	Devicenet BaudRate								
Byte 3	Input data length								
Byte 4	Output data length								

Data Description:

Source of Config Data: Device parameter configuration mode. (Default: 0)

0: The configuration software configuration is valid

1: The fieldbus controller configuration is valid

Fault ACTION for Input: Input data processing mode when I/O is faulty. (Default: 0)

0: Keep the last input value

1: Clears the input value

Fault ACTION for Output: Processing mode of output data when I/O is faulty. (Default: 1)

0: Hold the last output value

1: Clears the output value

Slave ID: DeviceNet slave ID number, hardware knob setting, 1-63 (read only, Default: 1)

Devicenet BaudRate: Devicenet bus baud rate setting (read only, Default: 1)

0: 125 kBit/sec

1: 250 kBit/sec

2: 500kBit/sec

Input data length: Devicenet input data length configuration. (read only, Default: 1 byte)

Output data length: Devicenet output data length configuration. (read only, Default: 1 byte)

A Dimensional Drawings

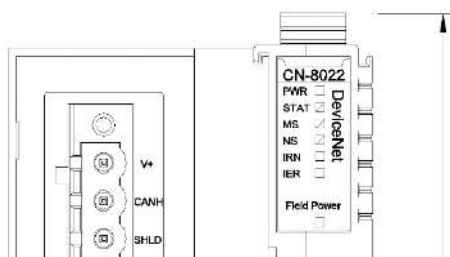

1

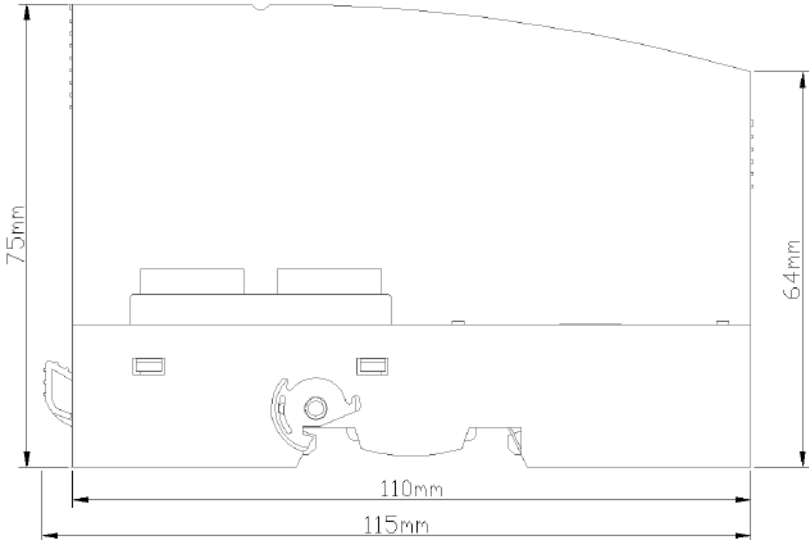

CN-8031 Modbus TCP Network Adapter

1 Module Overview

CN-8031 Modbus TCP Network Adapter supports the standard Modbus TCP Server Communication, and Ethernet supports the cascade function of dual-port switches. This adapter supports access to 5 Modbus TCP clients simultaneously, supports Modbus function code 01/02/03/04/05/06/15/16/23, supports the Modbus application of watchdog, supports the process data maximum sum of input and output of 8192 bytes, and supports number of the extension IO module of 32. Module carries with the diagnostic function and it can monitor the communication state of IO module in real time.

2 Technical Parameters

Hardware Specification	
System Power	Nominal:24VDC, Range: 20-30VDC Current: Max.2A@24VDC Protection: Reverse Protection, Overcurrent Protection
Power Consumption	50mA@24VDC
Internal BUS Supply Current	Max.2.5A@5VDC
Isolation	System Power to Field Power Isolation
Field Power	Nominal:24VDC, Range:20.4-28.8VDC
Field Power Current	Max. DC 8A
IO Modules Supported	32 pcs
Wiring	Max.: AWG 18 Min.: AWG 24
Installation	35mm DIN-Rail
Size	115*51.5*75mm
Weight	130g
Environment Specification	
Operating Temperature of Horizontal Installation	-35°C~70°C
Operating Temperature of Vertical Installation	-35°C~60°C
Relative Humidity	< 95%RH (No Condensation)
Storage Temperature	-40°C~85°C
Storage Humidity	< 95%RH (No Condensation)
Manufacturing Test Temperature	-40°C~75°C
Ingress Protection Rating	IP20
Communication Interface Specification	
Protocol	Modbus-TCP
Process Data Area	Sum of input and output:8192 Byte
Diagnostic Function	YES
Number of TCP	5 Clients
TCP Keepalive	YES
Modbus Watchdog	YES (Default: Enable, 30 Seconds)
Function Code	01/02/03/04/05/06/15/16/23
Network Interface	2*RJ45
Speed	10/100Mbps, MDI/MIDX, Full-Duplex
Distance	100m
IP Address	DIP switch set or set by IO-Config software

 **DANGER**

THERE IS A RISK OF ELECTRIC SHOCK, EXPLOSION, OR ARC FLASH.

Disconnect all devices from power, including connected devices, before removing any covers, or installing or removing any accessories, hardware, cables, or wires, except in specific circumstances specified in the appropriate hardware guidelines for this device.

Always use a voltage sensing device with an appropriate rating to detect a power outage at the appropriate place and time, as instructed.

Replace and tighten all covers, accessories, hardware, cables, and wires, and confirm that the ground connection is correct before powering on the device.

When operating this equipment and related products, the specified voltage must be used.

Failure to follow instructions specified by the manufacturer may result in serious consequences such as death, personal injury, or damage to equipment since the protection provided by the equipment may be impaired.

3 Hardware Interface

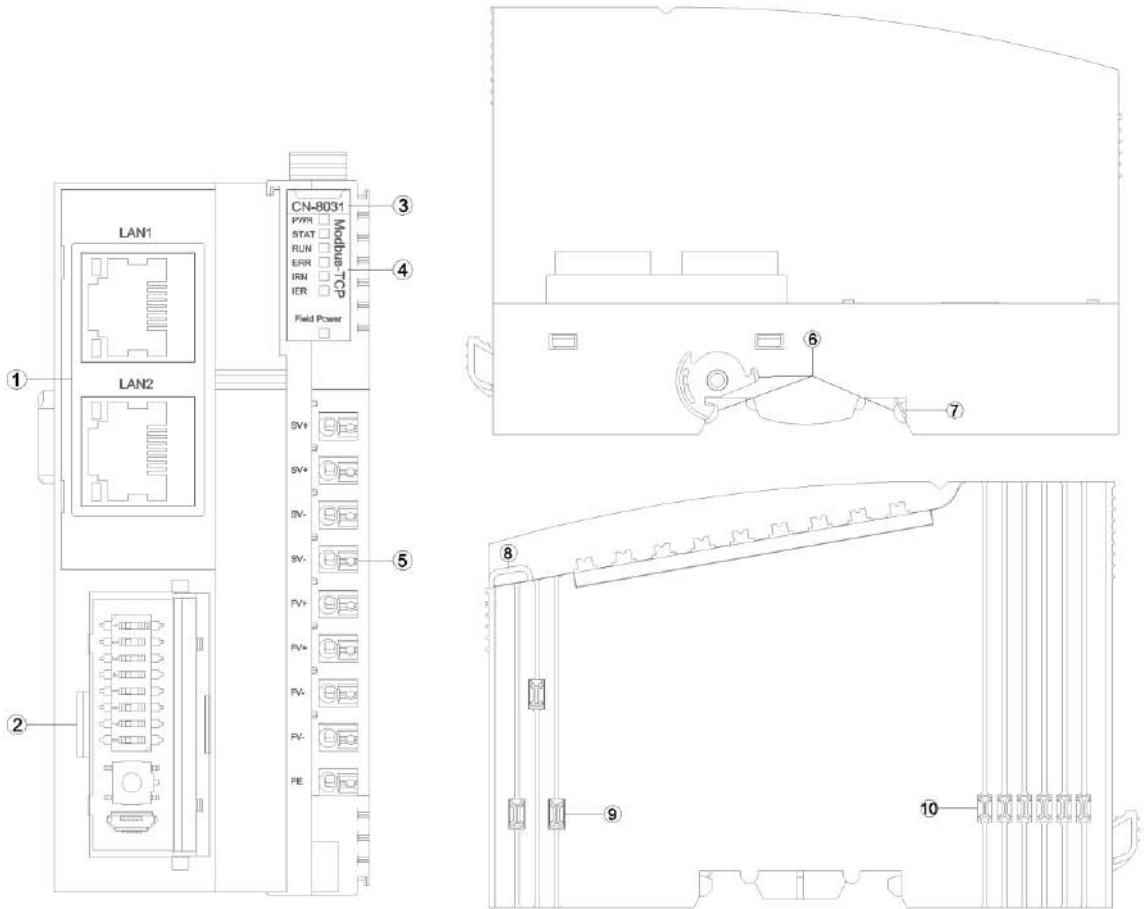

- ① Network Interface
- ② Config Interface
- ③ Module Type
- ④ LED Indicator
- ⑤ Wiring Terminal
- ⑥ Buckle
- ⑦ Grounding Spring Sheet
- ⑧ Fixed Wiring Harness
- ⑨ Field Power
- ⑩ Internal Bus

3.1 Network Interface

LAN1/LAN2 support switch function, 10Mbps and 100Mbps data rates, MDI/MID-X auto crossover.

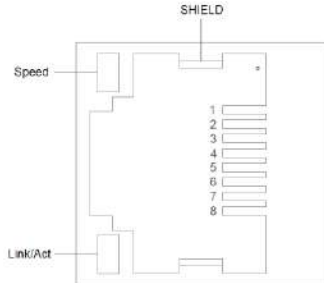

Speed: Network Speed (Green)

ON:100Mbps

OFF:10Mbps

Link/Act: Link State, Active State(Orange)

ON: Link UP

OFF: Link DOWN

Flash: Active

SHIELD: RJ45 Shield Interface

RJ45 Pin definition

Pin	Definition	Description
1	TD+	Transmitter Signal Positive
2	TD-	Transmitter Signal Negative
3	RD+	Receiver Signal Positive
4	--	--
5	--	--
6	RD-	Receiver Signal Negative
7	--	--
8	--	--

3.2 Configuration Interface

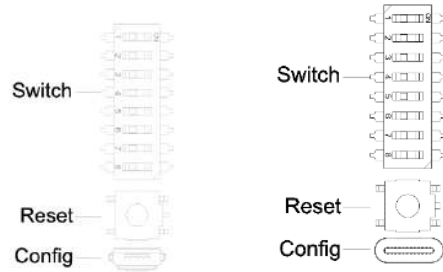

Switch: the DIP switch is used for setting the IP address (the default IP address is 192.168.1.100).

When the dial value is 0, all 4 bytes of the IP address are configured by the software or use the default IP address (192.168.1.100).

When the dial code value is not 0, the last byte of the IP address is determined by the dial code value, and the first three bytes could be configured by the software or use the default address(192.168.1).

The relationship between IP address and dial code value is shown in the following table:

Switch Bit Number (ON: 1, OFF: 0)								Switch Value	IP Address
1	2	3	4	5	6	7	8		
0	0	0	0	0	0	0	0	0	Configured by software
1	0	0	0	0	0	0	0	1	x.x.x.1
0	1	0	0	0	0	0	0	2	x.x.x.2
1	1	0	0	0	0	0	0	3	x.x.x.3
.
.
0	1	1	1	1	1	1	1	254	x.x.x.254
1	1	1	1	1	1	1	1	255	x.x.x.255
Notice: The default IP address after device reset is 192.168.1.100									

Reset: Module reset button, long pressing the button for more than 5 seconds and all parameters of the module will be restored to the default value. When the Reset button is activated, a green indicator will light up in the upper left corner of the button.

Config: Configure port, a standard Micro USB/Type-C interface for configuring device parameters and firmware upgrades.

 **WARNING**

OUT OF CONTROL

If the DIP Switch value is not 0, the DIP switch address value is the station address of the module. If the PLC communicates by assigning station address, there is a conflict between the allocated address and the DIP address. After power failure and restart, the DIP value address has a high priority, resulting in abnormal communication and module loss of control.

Failure to follow instructions specified by the manufacturer may result in serious consequences such as death, personal injury, or damage to equipment since the protection provided by the equipment may be impaired.

 **AVERTISSEMENT**

PERTE DE CONTROLE

Si la valeur du commutateur DIP n'est pas 0, la valeur de l'adresse du commutateur DIP est l'adresse de la station du module. Si le PLC communique en assignant l'adresse de la station, il y a un conflit entre l'adresse allouée et l'adresse DIP. Après une panne de courant et un redémarrage, l'adresse de valeur DIP a une priorité élevée, ce qui entraîne une communication anormale et une perte de contrôle du module.

Le fait de ne pas suivre les instructions peut entraîner une défaillance de la protection fournie par l'équipement, ce qui peut entraîner des conséquences graves, comme des blessures ou des dommages à l'équipement.

3.3 LED indicator

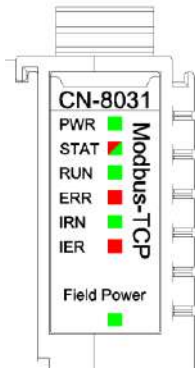

PWR Power State (GREEN)	Definition
ON	System Power Normal
OFF	System Power Failure
STAT Module State (RED/GREEN)	Definition
Double Flash (RED)	Module Soft Restarted by Hard-Fault
ON(GREEN)	Running
Single Flash (GREEN)	Stopping
Flash(2.5Hz) (RED/GREEN)	Boot Mode
Flash(10Hz) (RED/GREEN)	Firmware Updating
RUN Network State (GREEN)	Definition
ON	Modbus Connected
OFF	Modbus Disconnected
Flash	Modbus Read-write
Quadruple Flash	Led Test
Flash(10Hz)	MAC Address Error
ERR Network Error (RED)	Definition
Flash(2.5Hz)	LAN1 and LAN2 Link-Down
OFF	LAN1 or LAN2 Link-Up
Flash(10Hz)	MAC Address Error
IRN IO Run (GREEN)	Definition
ON	IO Initialization Normal
OFF	IO Initialization Failure
IER IO Error (RED)	Definition
OFF	IO Communication Normal
Double Flash	IO Communication Failure
Field Power State (GREEN)	Definition
ON	Field Power Normal
OFF	Field Power Failure

WARNING

UNEXPECTED EQUIPMENT OPERATION

By viewing the PW indicator, could determine the power supply status of a module. If the PW is steady green, the power supply is normal. Otherwise, the module cannot work properly.

When the module is initially powered on, there will be 3S for the backplane bus connection. After the backplane bus is initialized, STA is in the green steady state. If STA is in the green blinking state, it indicates that the backplane bus has not been initialized, and it needs to be powered off and restarted for re-initialization.

STA abnormal working state occurs during the normal operation of the module, please check the firmware version information of all modules, and consult ODOT technical support for details.

If a module is upgraded, check that all modules are in the normal state after the upgrade. Otherwise, an exception may occur.

Failure to follow instructions specified by the manufacturer may result in serious consequences such as death, personal injury, or damage to equipment since the protection provided by the equipment may be impaired.

AVERTISSEMENT

FONCTIONNEMENT INATTENDU DE L'EQUIPEMENT

En regardant l'état de l'indicateur de PW, jugez l'état d'alimentation du module. Le feu vert PW reste allumé et l'alimentation est normale. Autrement, le module ne fonctionnera pas correctement.

Lorsque le module est alimenté initialement, il y aura 3S pour la connexion de bus de backboard. STA est un état vert permanent après l'initialisation du bus de backboard. Si STA est en état de clignotement vert, cela signifie que l'initialisation du bus de backboard n'est pas passée et doit être redémarrée hors tension et réinitialisée.

L'état de fonctionnement anormal de STA se produit pendant le fonctionnement normal du module, veuillez vérifier les informations de version du firmware de tous les modules, et consulter le support technique ODOT pour plus de détails.

Si le module a une opération de mise à niveau, après l'achèvement de la mise à niveau, le besoin de vérifier que tous les modules sont dans l'état normal avant de courir, sinon il conduira à une exception.

Le fait de ne pas suivre les instructions peut entraîner une défaillance de la protection fournie par l'équipement, ce qui peut entraîner des conséquences graves, comme des blessures ou des dommages à l'équipement.

4 Wiring

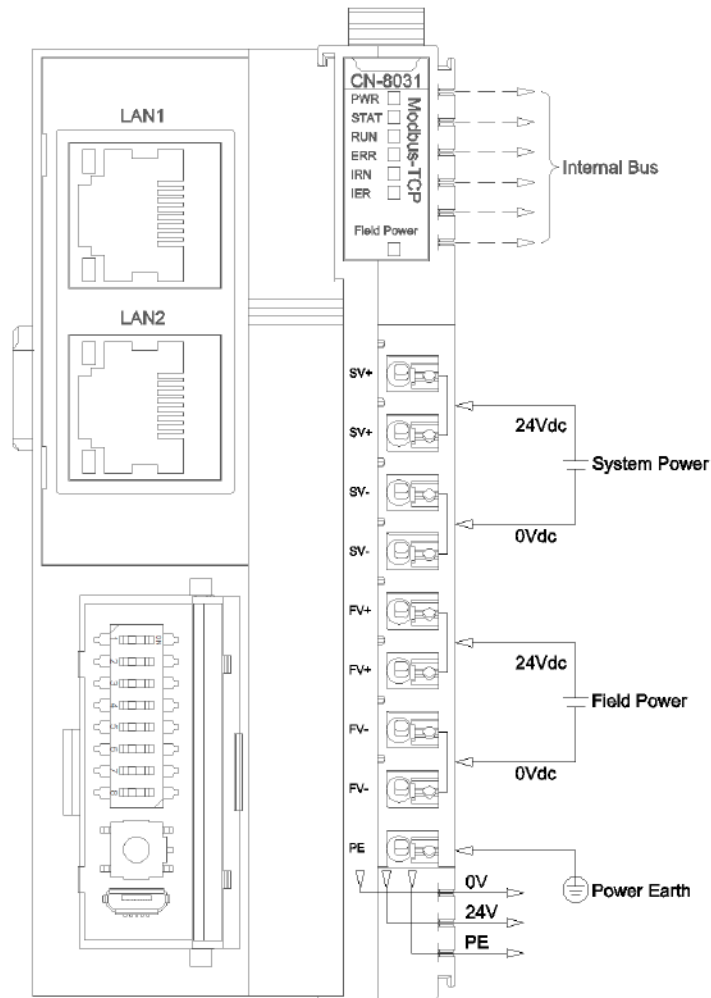

NOTICE

UNEXPECTED DEVICE OPERATION

Inside the module, two terminal blocks SV+ have been shorted, two terminal blocks SV - have been shorted, two terminal blocks FV+ have been shorted, and two terminal blocks FV - have been shorted. Externally, only one system power supply and one field power supply need to be connected.

The wire should be copper wire with a core greater than 0.2mm² and less than 1mm², and the impedance is less than 10Ω.

Failure to follow instructions specified by the manufacturer may result in serious consequences such as death, personal injury, or damage to equipment since the protection provided by the equipment may be impaired.

5 Process data definition

Adapter process data definition

Modbus-TCP adapter itself has no input-output process data.

IO Module process data mapping

The network adapter reads and writes input and output process data of IO module in real time through the internal bus, and its data mapping model is shown as follow:

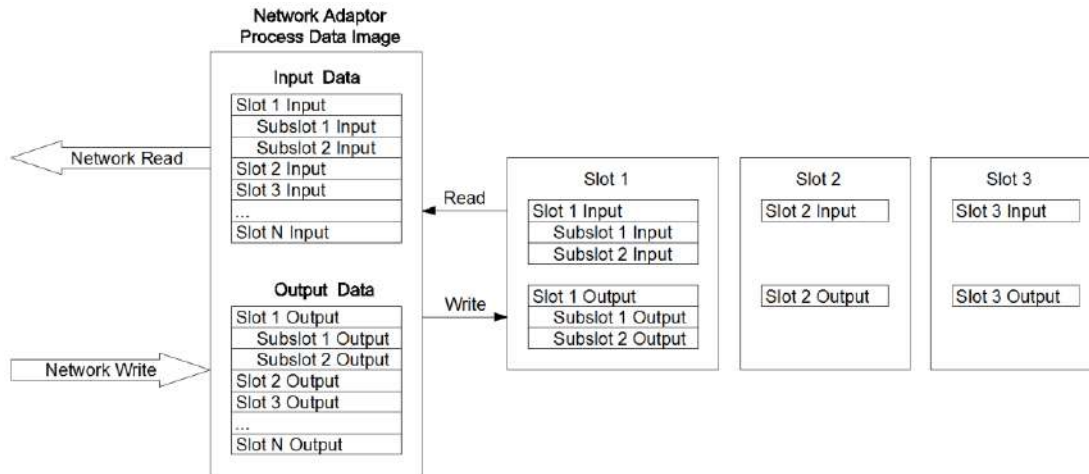

Modbus address mapping table varies according to module combination, and the I/O module address mapping table carried by CN-8031 has two modes.

In the 1st mode, it could use the IOConfig configured software to check whether DI is mapped to area 1, DO is mapped to area 0, AI is mapped to area 3, and AO is mapped to area 4. For special module addresses, it could check the address table in the IOConfig configured software.

In another mode, DI, DO, AI, AO, and special module addresses are all mapped to area 4, and they are corresponding to different address ranges respectively. The addresses of special modules are sorted backwards in sequence referred to the address table in IOConfig. And the mapping address ranges are shown in the following table.

Module Type	Address Offset		Read/Write
	Hex	Decimal	
AO	0x0000	0	Read & Write
DO	0x3000	12288	Read & Write
AI	0x4000	16384	Read only
DI	0x5000	20480	read only

6 Configuration Parameter Definition

Configuration Parameter								
Bit No	Bit 7	Bit 6	Bit 5	Bit 4	Bit 3	Bit 2	Bit 1	Bit 0
Byte 0	Reserved			Sniffer Port	Port Mirroring	Reserved	Fault Action for Input	Source of Config Data
Byte 1	MAC Address [0]							
Byte 2	MAC Address [1]							
Byte 3	MAC Address [2]							
Byte 4	MAC Address [3]							
Byte 5	MAC Address [4]							
Byte 6	MAC Address [5]							
Byte 7	IP Address [0]							
Byte 8	IP Address [1]							
Byte 9	IP Address [2]							
Byte 10	IP Address [3]							
Byte 11	Net Mask [0]							
Byte 12	Net Mask [1]							
Byte 13	Net Mask [2]							
Byte 14	Net Mask [3]							
Byte 15	Net Gateway [0]							
Byte 16	Net Gateway [1]							
Byte 17	Net Gateway [2]							
Byte 18	Net Gateway [3]							
Byte 19	Modbus Port							
Byte 20								
Byte 21	Reserved							Watchdog
Byte 22	Watchdog Time(s)							
Byte 23								

Data description:

Source of Config Data: Parameter configuration mode (Default: 0)

0: Configuration Software

Fault Action for Input: Input fault handling mode, when IO module is offline, the adapter will process IO module input data according to this mode.

0: Hold Last Input Value

1: Clear Input Value

Port Mirroring: The port mirroring function could mirror the message of adapter network

data to LAN1 or LAN2 for output. (Default: 0)

0: Disable

1: Enable

Sniffer Port: Mirror port, which is used to monitor adapter network message data when port mirror function is enabled. (Default: 0)

0: LAN1

1: LAN2

MAC Address: MAC address, read-only property.

IP Address: Adapter IP address, when the value of the dial-code switch is not 0, the last byte of the IP address is replaced by the dial-code value.

Net Mask: Subnet mask.

Net Gateway: Gateway address.

Modbus Port: Modbus-TCP server port number. (Default: 502)

Watchdog: Modbus watchdog. (Default: 1)

0: Disable

1: Enable

Watchdog Time(s): Modbus application watchdog period, when the watchdog is enabled, if there is no Modbus data exchange on the TCP connection in this period, the TCP connection will be disconnected (other TCP connections with data exchange will be remained normally). (Default: 30)

7 System diagnostic area

System diagnostic area is divided into two parts.

The first part: "State input" storage area, address 0x2000 ~ 0x2068, a total of 105 Word.

No.	Storage Type	Description	Storage Capacity	Address Range	Read-write
1	3 Area	System diagnosis - Status input	105 Word	0x2000~0x2068	RO

Modbus client monitors the address area 0x2000~0x2068 by calling Modbus 04 function code to obtain the current working status and error code of the adapter and IO module, the data format is shown as below:

No.	Modbus Address (Decimalism)	Address (Hexadecimal)	Data Name	Description
1	8192	0x2000	<u>Reset Mode</u>	Reset State*
2	8193	0x2001	Reserve	
3	8194	0x2002	DIP switch value	
4	8195	0x2003	Running time - Second	
5	8196	0x2004	Running time - Minute	
6	8197	0x2005	Running time - Hour	
7	8198	0x2006	Running time - Day	
8	8199	0x2007	MAC	Current Device MAC
9	8200	0x2008		
10	8201	0x2009		
11	8202	0x200A	IP	Current Device IP
12	8203	0x200B		
13	8204	0x200C	MASK	Current Device MASK
14	8205	0x200D		
15	8206	0x200E	GATEWAY	Current Device GATEWAY
16	8207	0x200F		
17	8208	0x2010	DI-size	Discrete quantity input area data size
18	8209	0x2011	DO-size	Coil output area data size
19	8210	0x2012	AI-size	Input register area data size
20	8211	0x2013	AO-size	Holding register area data size
21	8212	0x2014	Config-Client-IP	Configured client IP
22	8213	0x2015		

23	8214	0x2016	Config-Client-Port	Configured client port
24	8215	0x2017	Modbus-Client-Number	Connected Modbus client number
25	8216	0x2018	Modbus-Client-1-IP	Client 1-IP
26	8217	0x2019		
27	8218	0x201A	Modbus-Client-1-Port	Client 1-Port
28	8219	0x201B	Modbus-Client-2-IP	Client 2-IP
29	8220	0x201C		
30	8221	0x201D	Modbus-Client-2-Port	Client 2-Port
31	8222	0x201E	Modbus-Client-3-IP	Client 3-IP
32	8223	0x201F		
33	8224	0x2020	Modbus-Client-3-Port	Client 3-Port
34	8225	0x2021	Modbus-Client-4-IP	Client 4-IP
35	8226	0x2022		
36	8227	0x2023	Modbus-Client-4-Port	Client 4-Port
37	8228	0x2024	Modbus-Client-5-IP	Client 5-IP
38	8229	0x2025		
39	8230	0x2026	Modbus-Client-5-Port	Client 5-Port
40	8231	0x2027	Module_Error[0]	Module 0 error code
41	8232	0x2028		
42	8233	0x2029	Module_Error[1]	Module 1 error code
43	8234	0x202A		
44	8235	0x202B	Module_Error[2]	Module 2 error code
45	8236	0x202C		
46	8237	0x202D	Module_Error[3]	Module 3 error code
47	8238	0x202E		
48	8239	0x202F	Module_Error[4]	Module 4 error code
49	8240	0x2030		
50	8241	0x2031	Module_Error[5]	Module 5 error code
51	8242	0x2032		
52	8243	0x2033	Module_Error[6]	Module 6 error code
53	8244	0x2034		
54	8245	0x2035	Module_Error[7]	Module 7 error code
55	8246	0x2036		
56	8247	0x2037	Module_Error[8]	Module 8 error code
57	8248	0x2038		
58	8249	0x2039	Module_Error[9]	Module 9 error code
59	8250	0x203A		
60	8251	0x203B	Module_Error[10]	Module 10 error code
61	8252	0x203C		

62	8253	0x203D	Module_Error[11]	Module 11 error code
63	8254	0x203E		
64	8255	0x203F	Module_Error[12]	Module 12 error code
65	8256	0x2040		
66	8257	0x2041	Module_Error[13]	Module 13 error code
67	8258	0x2042		
68	8259	0x2043	Module_Error[14]	Module 14 error code
69	8260	0x2044		
70	8261	0x2045	Module_Error[15]	Module 15 error code
71	8262	0x2046		
72	8263	0x2047	Module_Error[16]	Module 16 error code
73	8264	0x2048		
74	8265	0x2049	Module_Error[17]	Module 17 error code
75	8266	0x204A		
76	8267	0x204B	Module_Error[18]	Module 18 error code
77	8268	0x204C		
78	8269	0x204D	Module_Error[19]	Module 19 error code
79	8270	0x204E		
80	8271	0x204F	Module_Error[20]	Module 20 error code
81	8272	0x2050		
82	8273	0x2051	Module_Error[21]	Module 21 error code
83	8274	0x2052		
84	8275	0x2053	Module_Error[22]	Module 22 error code
85	8276	0x2054		
86	8277	0x2055	Module_Error[23]	Module 23 error code
87	8278	0x2056		
88	8279	0x2057	Module_Error[24]	Module 24 error code
89	8280	0x2058		
90	8281	0x2059	Module_Error[25]	Module 25 error code
91	8282	0x205A		
92	8283	0x205B	Module_Error[26]	Module 26 error code
93	8284	0x205C		
94	8285	0x205D	Module_Error[27]	Module 27 error code
95	8286	0x205E		
96	8287	0x205F	Module_Error[28]	Module 28 error code
97	8288	0x2060		
98	8289	0x2061	Module_Error[29]	Module 29 error code
99	8290	0x2062		
10 0	8291	0x2063	Module_Error[30]	Module 30 error code
10 1	8292	0x2064		
10 2	8293	0x2065	Module_Error[31]	Module 31 error code

10 3	8294	0x2066		
10 4	8295	0x2067	Module_Error[32]	Module 32 error code
10 5	8296	0x2068		

*Reset state Register 38193 address data format is shown as below:

Address offset	Address name	Description	Power on default value
Bit 0	Power_On_Reset	Power on reset	0/1
Bit 1-3	Reserved	Reserved	0
Bit 4	External_Reset	External Reset	0/1
Bit 5	Reserved	Reserved	0
Bit 6	Soft_Reset_Request	Soft Reset	0
Bit 7	Reserved	Reserved	0
Bit 8	HardFault	Hard Fault Reset	0
Bit 9	StackOver	Stack Over Reset	0
Bit 10	MemoryOver	Memory Over Reset	0
Bit 11-15	Reserved	Reserved	0

The second part: "Control Output" storage area, address 0x2000, a total of 1 Word.

No.	Storage Type	Description	Storage Capacity	Address Range	Read-write
1	4 Area	System diagnosis - Control output	1 Word	0x2000	RW

The

Modbus client controls the address 0x2000 by calling Modbus 06/16 function code to implement block reset or port mirroring control.

Register 408193 address data format is shown as below:

Address offset	Address Name	Description	Value range	Default value
Bit 0	Restart	0->1 Rising edge triggering system reset	0-1	0
Bit1	Port_mirror	Port mirroring function enable 0: disabled 1: enable	0-1	0: disabled
Bit 2	Sniffer_port	Mirror port selection 0:LAN1 1:LAN2	0-1	0:LAN1
Bit 3-15	Reserved	Reserved	0	0

A Dimension drawing

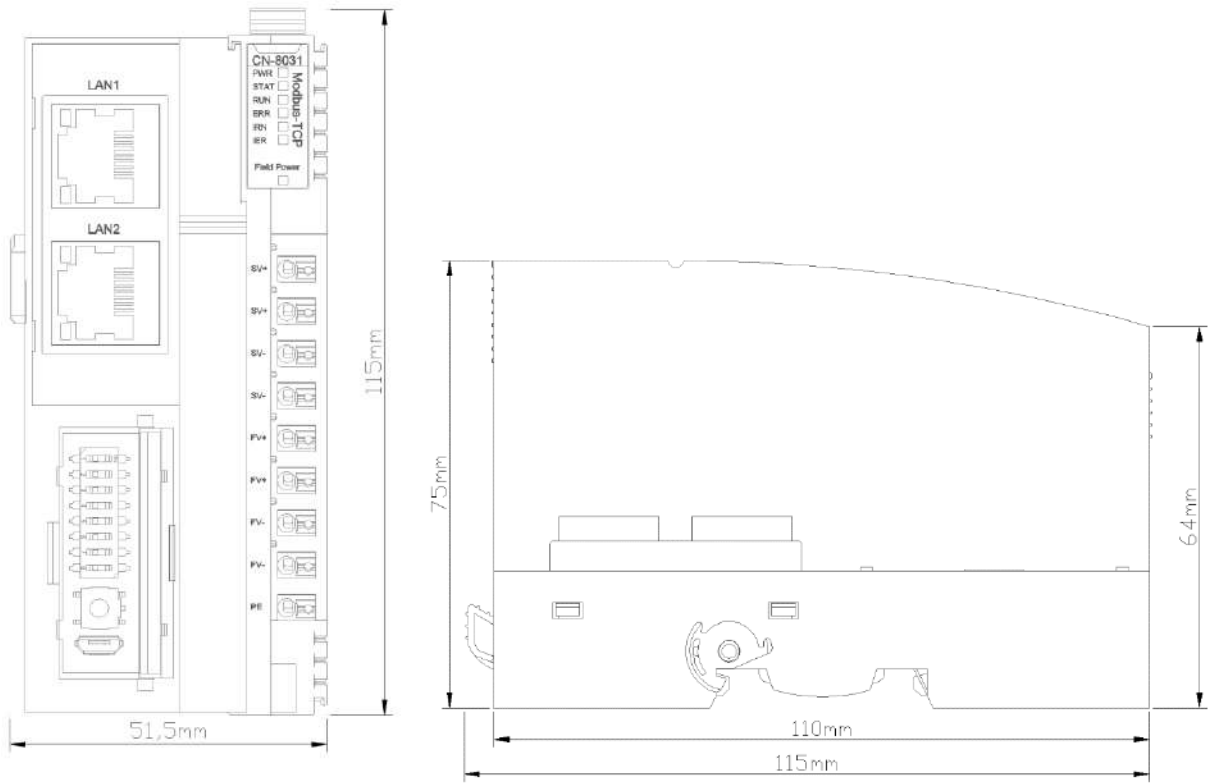

CN-8032 Profinet Network Adapter

1 The module overview

The CN-8032 Profinet network adapter supports standard Profinet IO Device Communication. The adapter supports MRP media redundancy, and it could realize ring network. And it supports RT/IRT real-time and synchronous communication mode, with its RT real-time communication minimum period of 1ms and IRT synchronous communication minimum period of 250us. The adapter supports a maximum input of 1440 bytes, a maximum output of 1440 bytes, and the number of the extended IO modules it supports is 32.

2 Technical Parameters

Hardware Specification	
System Power	Nominal: 24VDC, Range: 20-30VDC Current: Max.2A@24VDC Protection: Reverse Protection, Overcurrent Protection
Power Consumption	110mA@24VDC
Internal BUS Supply Current	Max:2A@5VDC
Isolation	System Power to Field Power Isolation
Field Power	Nominal: 24VDC, Range: 20.4-28.8VDC
Field Power Current	Max DC 8A
IO Modules Supported	32 pcs
Wiring	Max.: AWG 18 Min.: AWG 24
Installation	35mm DIN-Rail
Size	115*51.5*75mm
Weight	130g
Environment Specification	
Operating Temperature of Horizontal Installation	-35°C~70°C
Operating Temperature of Vertical Installation	-35°C~60°C
Relative Humidity	< 95%RH (No Condensation)
Storage Temperature	-40°C~85°C
Storage Humidity	< 95%RH (No Condensation)
Manufacturing Test Temperature	-40°C~75°C
Ingress Protection Rating	IP20
Profinet Parameter	
Protocol	Profinet IO Device
I/O Data Size	Input Max 1440 Bytes, Output Max 1440 Bytes
RT	Supported, Min.1ms
IRT	Supported, Min.250us
MRP	Supported
MRPD	Not supported
Network Interface	2*RJ45
Speed	10/100Mbps, MDI/MIDX, Full-Duplex
Max bus distance	100m
Profinet Device Name	DIP switch setting or Profinet monitor modifying

Notice: The adapter does not support the MRPD (Media Redundancy for Planned Duplication) function, so the MRP and IRT functions cannot be used simultaneously.

 **DANGER**

THERE IS A RISK OF ELECTRIC SHOCK, EXPLOSION, OR ARC FLASH.

Disconnect all devices from power, including connected devices, before removing any covers, or installing or removing any accessories, hardware, cables, or wires, except in specific circumstances specified in the appropriate hardware guidelines for this device.

Always use a voltage sensing device with an appropriate rating to detect a power outage at the appropriate place and time, as instructed.

Replace and tighten all covers, accessories, hardware, cables, and wires, and confirm that the ground connection is correct before powering on the device.

When operating this equipment and related products, the specified voltage must be used.

Failure to follow instructions specified by the manufacturer may result in serious consequences such as death, personal injury, or damage to equipment since the protection provided by the equipment may be impaired.

3 Hardware Interface

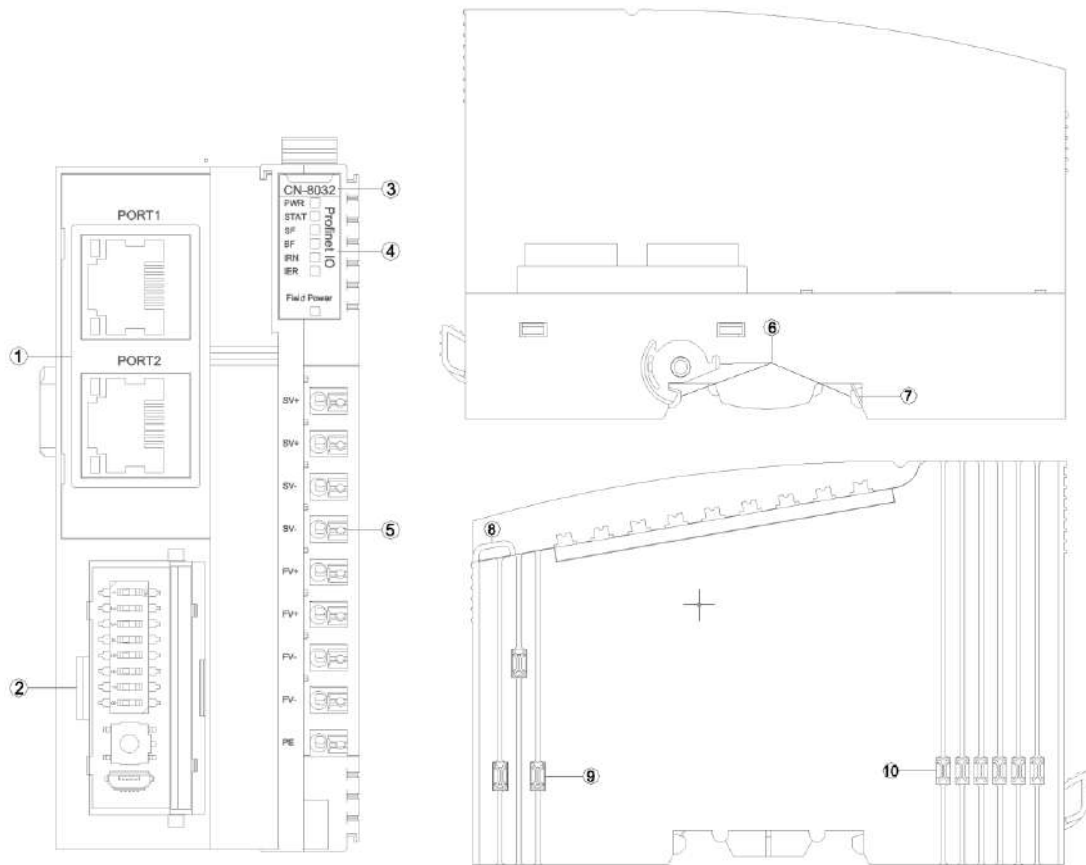

- ① Network Interface
- ② Config Interface
- ③ Module Type
- ④ LED Indicator
- ⑤ Wiring Terminal
- ⑥ Buckle
- ⑦ Grounding Spring Sheet
- ⑧ Fixed Wiring Harness
- ⑨ Field Power
- ⑩ Internal Bus

3.1 Network Interface

PORT1 and PORT2 are both Profinet communication port, and support switch function with 10Mbps and 100Mbps data rates, MDI/MID-X auto crossover.

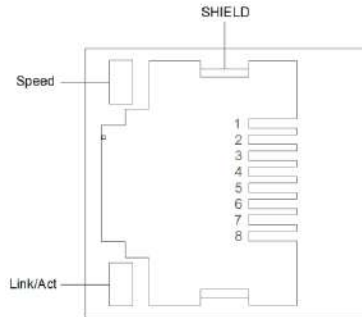

Speed: Network Speed LED (Green)

ON: 100Mbps

OFF: 10Mbps

Link/Act: Link State, Active State(Orange)

ON: Link UP

OFF: Link DOWN

Flash: Active

SHIELD: RJ45 Shield Interface

RJ45 Pin definition

Pin	Definition	Description
1	TD+	Transmitter Signal Positive
2	TD-	Transmitter Signal Negative
3	RD+	Receiver Signal Positive
4	--	--
5	--	--
6	RD-	Receiver Signal Negative
7	--	--
8	--	--

3.2 Configuration Interface

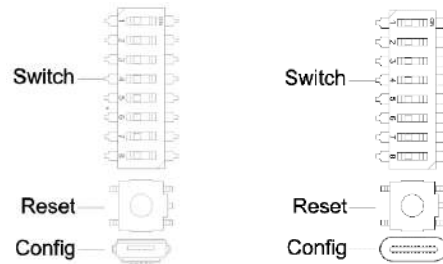

Switch: The DIP switch is used to set the name of Profinet device.

When the DIP switch value is 0, the device default name is cn8032-addr, and it could use Profinet monitor to set the device name online.

When the dial-code switch value is not 0, the device name is determined by the value of the DIP switch. The relationship between the device name and the dial value is shown in the following table:

Switch Bit Number(ON:1,OFF:0)								Switch Value	Profinet Deice Name
1	2	3	4	5	6	7	8		
0	0	0	0	0	0	0	0	0	Configured By Software (Default:cn8032-addr)
1	0	0	0	0	0	0	0	1	cn8032-1
0	1	0	0	0	0	0	0	2	cn8032-2
.
0	1	0	1	0	0	0	0	10	cn8032-10
.
0	1	1	1	1	1	1	1	254	cn8032-254
1	1	1	1	1	1	1	1	255	cn8032-255
<i>Description: Factory default dial code value is 0, the device name is cn8032-addr.</i>									

Reset: Module reset button. All parameters of the module will be restored to the default value after pressing the button for more than 5 seconds. When the Reset button is pressed, a green LED will light up in the upper left corner of the button.

Config: Configure port, a standard Micro USB/Type-C interface for configuring device parameters and firmware upgrades.

Description: device parameters can be set in Profinet IO controller configuration software.

⚠ WARNING
OUT OF CONTROL

If the DIP Switch value is not 0, the DIP switch address value is the station address of the module. If the PLC communicates by assigning station address, there is a conflict between the allocated address and the DIP address. After power failure and restart, the DIP value address has a high priority, resulting in abnormal communication and module loss of control.

Failure to follow instructions specified by the manufacturer may result in serious consequences such as death, personal injury, or damage to equipment since the protection provided by the equipment may be impaired.

 **AVERTISSEMENT**

PERTE DE CONTROLE

Si la valeur du commutateur DIP n'est pas 0, la valeur de l'adresse du commutateur DIP est l'adresse de la station du module. Si le PLC communique en assignant l'adresse de la station, il y a un conflit entre l'adresse allouée et l'adresse DIP. Après une panne de courant et un redémarrage, l'adresse de valeur DIP a une priorité élevée, ce qui entraîne une communication anormale et une perte de contrôle du module.

Le fait de ne pas suivre les instructions peut entraîner une défaillance de la protection fournie par l'équipement, ce qui peut entraîner des conséquences graves, comme des blessures ou des dommages à l'équipement.

3.3 LED Indicators

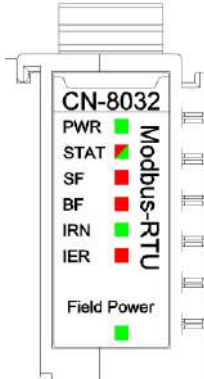

PWR Power State (GREEN)	Definition
ON	System Power Normal
OFF	System Power Failure
STAT Module State (RED/GREEN)	Definition
Double Flash (RED)	Module Soft Restart by Hard-Fault
ON(GREEN)	Operating
Single Flash (GREEN)	Stopping
Flash(2.5Hz) (RED/GREEN)	Boot Mode
Flash(10Hz) (RED/GREEN)	Firmware Update
SF System Failure (RED)	Definition
OFF	Normal
ON	System Failure, Topology Error
Flash	Led light test
Flash(10Hz)	MAC Address Error
BF Bus Failure (RED)	Definition
ON	Port1 and Port2 Link-Down
Flash(2.5Hz)	Offline Mode
OFF	Online Mode
Flash(10Hz)	MAC Address Error
IRN IO RUN(GREEN)	Definition
ON	IO Initialization Normal
OFF	IO Initialization Failure
IER IO Error (RED)	Definition
OFF	IO Communication Normal
Double Flash	IO Communication Failure
Field Power State (GREEN)	Definition
ON	Field Power Normal
OFF	Field Power Failure

WARNING

UNEXPECTED EQUIPMENT OPERATION

By viewing the PW indicator, could determine the power supply status of a module. If the PW is steady green, the power supply is normal. Otherwise, the module cannot work properly.

When the module is initially powered on, there will be 3S for the backplane bus connection. After the backplane bus is initialized, STA is in the green steady state. If STA is in the green blinking state, it indicates that the backplane bus has not been initialized, and it needs to be powered off and restarted for re-initialization.

STA abnormal working state occurs during the normal operation of the module, please check the firmware version information of all modules, and consult ODOT technical support for details.

If a module is upgraded, check that all modules are in the normal state after the upgrade. Otherwise, an exception may occur.

Failure to follow instructions specified by the manufacturer may result in serious consequences such as death, personal injury, or damage to equipment since the protection provided by the equipment may be impaired.

AVERTISSEMENT

FONCTIONNEMENT INATTENDU DE L'EQUIPEMENT

En regardant l'état de l'indicateur de PW, jugez l'état d'alimentation du module. Le feu vert PW reste allumé et l'alimentation est normale. Autrement, le module ne fonctionnera pas correctement.

Lorsque le module est alimenté initialement, il y aura 3S pour la connexion de bus de backboard. STA est un état vert permanent après l'initialisation du bus de backboard. Si STA est en état de clignotement vert, cela signifie que l'initialisation du bus de backboard n'est pas passée et doit être redémarrée hors tension et réinitialisée.

L'état de fonctionnement anormal de STA se produit pendant le fonctionnement normal du module, veuillez vérifier les informations de version du firmware de tous les modules, et consulter le support technique ODOT pour plus de détails.

Si le module a une opération de mise à niveau, après l'achèvement de la mise à niveau, le besoin de vérifier que tous les modules sont dans l'état normal avant de courir, sinon il conduira à une exception.

Le fait de ne pas suivre les instructions peut entraîner une défaillance de la protection fournie par l'équipement, ce qui peut entraîner des conséquences graves, comme des blessures ou des dommages à l'équipement.

4 Wiring

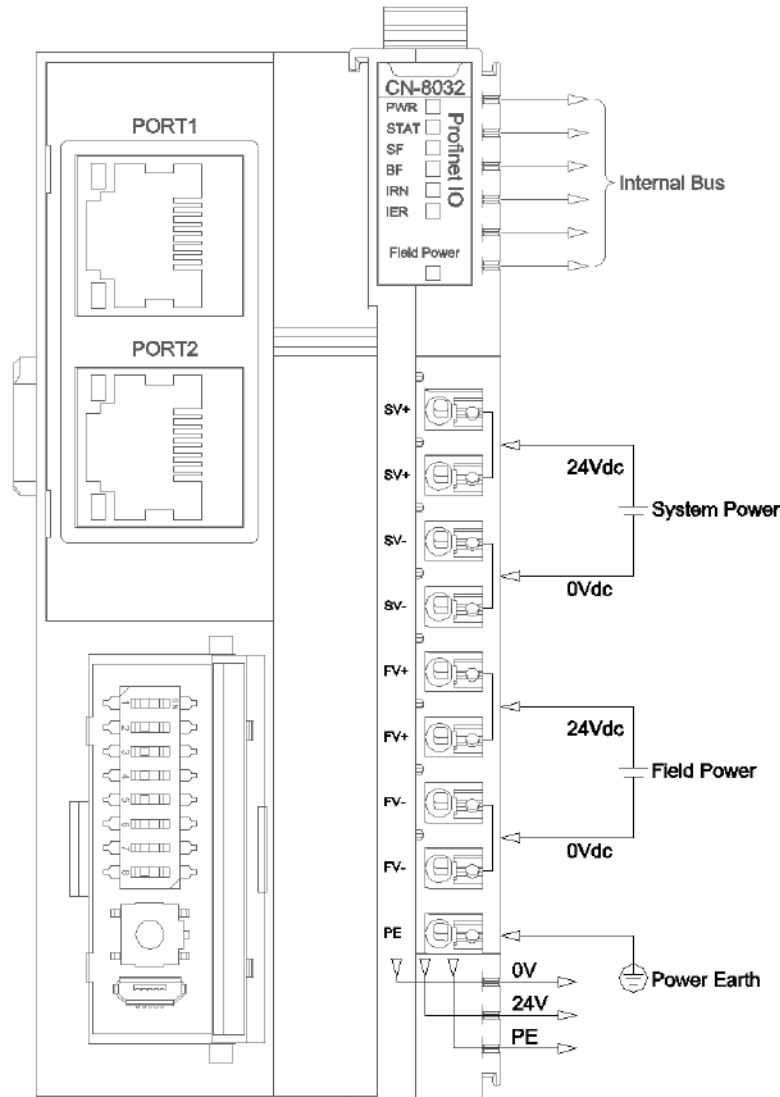

NOTICE

UNEXPECTED DEVICE OPERATION

Inside the module, two terminal blocks SV+ have been shorted, two terminal blocks SV - have been shorted, two terminal blocks FV+ have been shorted, and two terminal blocks FV - have been shorted. Externally, only one system power supply and one field power supply need to be connected.

The wire should be copper wire with a core greater than 0.2mm^2 and less than 1mm^2 , and the impedance is less than 10Ω .

Failure to follow instructions specified by the manufacturer may result in serious consequences such as death, personal injury, or damage to equipment since the protection provided by the equipment may be impaired.

5 Process data definition

5.1 Adapter process data definition

Profinet adapter itself has no input-output process data.

5.2 IO module process data mapping

The network adapter reads and writes input and output process data of IO module in real time through the internal bus, and its data mapping model is shown as follow:

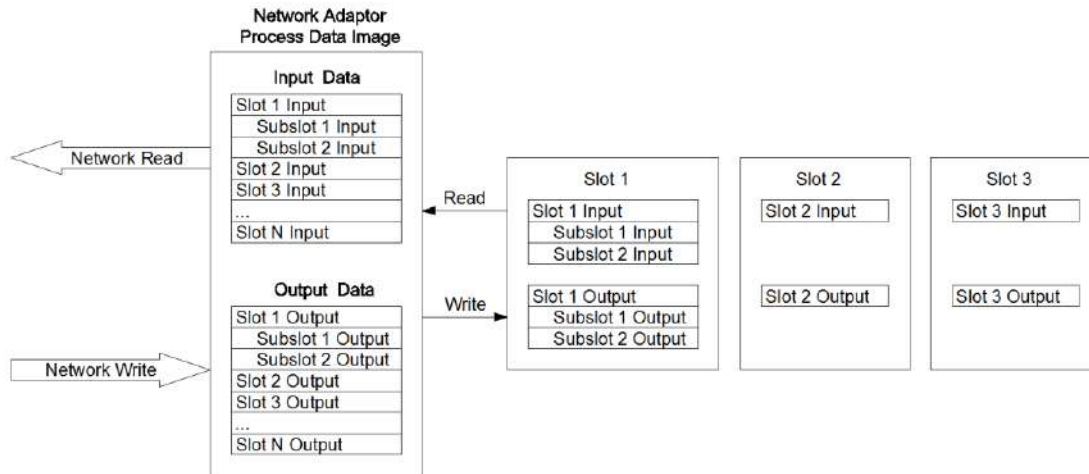

The maximum number of input bytes of the Profinet network adapter is 1440 bytes, and the maximum number of output bytes is 1440 bytes.

6 Configuration parameters definition

Configuration parameters									
Bit No	Bit 7	Bit 6	Bit 5	Bit 4	Bit 3	Bit 2	Bit 1	Bit 0	
Byte 0	Reserved					Fault Action for Output	Fault Action for Input	Source of Config Data	
Byte 1	MAC Address [0]								
Byte 2	MAC Address [1]								
Byte 3	MAC Address [2]								
Byte 4	MAC Address [3]								
Byte 5	MAC Address [4]								
Byte 6	MAC Address [5]								
Byte 7	IP Address [0]								
Byte 8	IP Address [1]								
Byte 9	IP Address [2]								
Byte 10	IP Address [3]								
Byte 11	Net Mask [0]								
Byte 12	Net Mask [1]								
Byte 13	Net Mask [2]								
Byte 14	Net Mask [3]								
Byte 15	Net Gateway [0]								
Byte 16	Net Gateway [1]								
Byte 17	Net Gateway [2]								
Byte 18	Net Gateway [3]								
Byte 19 ... Byte 82	Profinet Device Name								

Data description:

Source of Config Data: Parameter configuration mode (Default: 1)

0: Configure software

1: Field Bus

Fault Action for Input: Input fault handling mode, when IO module is offline, the adapter will process IO module input data according to this mode. (Default: 0)

0: Hold Last Input Value

1: Clearing Input Value

Fault Action for Output: Output fault handling mode, when the fieldbus is offline the adapter will process the IO module output data according to this mode. (Default: 1)

0: Hold Last Output Value

1: Clearing Output Value

MAC Address: MAC address, read-only.

IP Address: IP address, read-only.

Net Mask: Subnet mask, read-only.

Net Gateway: Gateway address, read-only.

Profinet Device Name: Profinet device name, read-only. (Device name is determined by the DIP switch)

A Dimension drawing

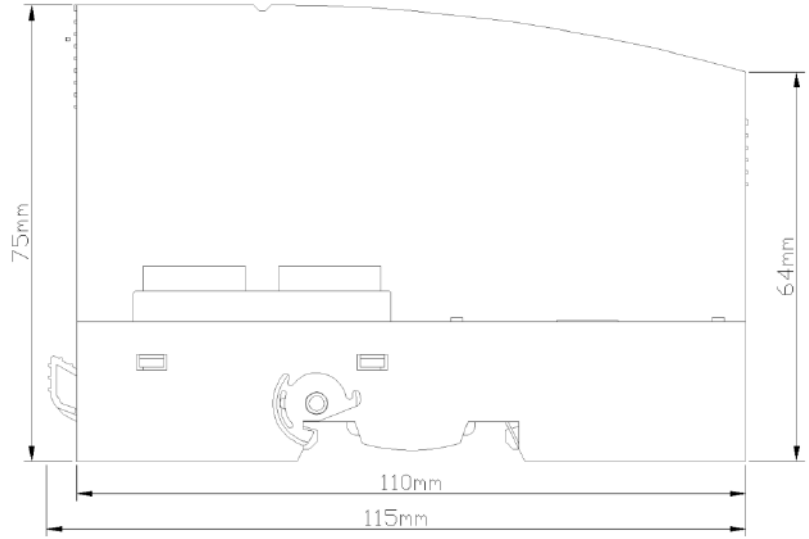
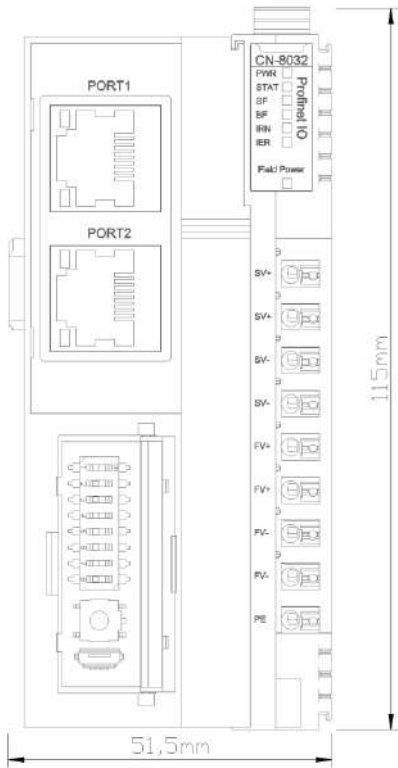

CN-8032-L Profinet Network Adapter

1 The module overview

The CN-8032-L Profinet network adapter supports standard Profinet IO Device Communication. **The adapter supports no MRP redundancy, and no ring network redundancy.** And it supports RT real-time communication mode, with its RT real-time communication minimum period of 1ms. The adapter supports a maximum input of 1440 bytes, a maximum output of 1440 bytes, and the number of the extended IO modules it supports is 32.

2 Technical Parameters

Hardware Specification	
System Power	Nominal:24VDC, Range: 20-30VDC Current: Max.2A@24VDC Protection: Reverse Protection, Overcurrent Protection
Power Consumption	110mA@24VDC
Internal BUS Supply Current	Max:2A@5VDC
Isolation	System Power to Field Power Isolation
Field Power	Nominal: 24VDC, Range: 20.4-28.8VDC
Field Power Current	Max DC 8A
IO Modules Supported	32 pcs
Wiring	Max.: AWG 18 Min.: AWG 24
Installation	35mm DIN-Rail
Size	115*51.5*75mm
Weight	130g
Vibration Resistance	Comply with IEC 61131-2 and EC 60068-2-6
Impact resistance	Comply with IEC 61131-2 and IEC 60068-2-27
EMC Performance	Comply with IEC 61131-2 and IEC 61000-4
Environment Specification	
Operating Temperature of Horizontal Installation	-35°C~70°C
Operating Temperature of Vertical Installation	-35°C~60°C
Relative Humidity	< 95%RH (No Condensation)
Storage Temperature	-40°C~85°C
Storage Humidity	< 95%RH (No Condensation)
Manufacturing Test Temperature	-40°C~75°C
Ingress Protection Rating	IP20
Profinet Parameter	
Protocol	Profinet IO Device
I/O Data Size	Input Max 1440 Bytes, Output Max 1440 Bytes
RT	Supported, Min. 1ms
IRT	Not supported
MRP	Not supported
MRPD	Not supported
Network Interface	2*RJ45
Speed	10/100Mbps, MDI/MIDX, Full-Duplex
Max bus distance	100m

Profinet Device Name	DIP switch setting or Profinet monitor modifying
----------------------	--

  **DANGER**

THERE IS A RISK OF ELECTRIC SHOCK, EXPLOSION, OR ARC FLASH.

Disconnect all devices from power, including connected devices, before removing any covers, or installing or removing any accessories, hardware, cables, or wires, except in specific circumstances specified in the appropriate hardware guidelines for this device.

Always use a voltage sensing device with an appropriate rating to detect a power outage at the appropriate place and time, as instructed.

Replace and tighten all covers, accessories, hardware, cables, and wires, and confirm that the ground connection is correct before powering on the device.

When operating this equipment and related products, the specified voltage must be used.

Failure to follow instructions specified by the manufacturer may result in serious consequences such as death, personal injury, or damage to equipment since the protection provided by the equipment may be impaired.

3 Hardware Interface

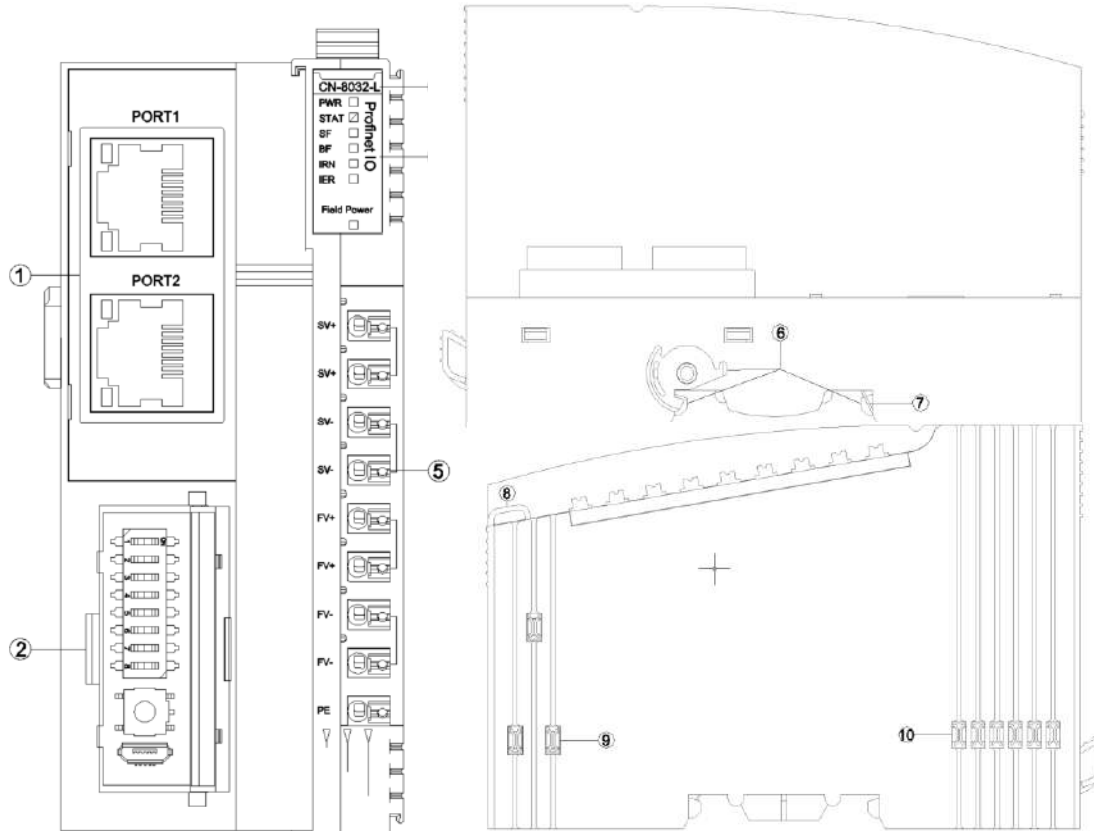

- ① Network Interface
- ② Config Interface
- ③ Module Type
- ④ LED Indicator
- ⑤ Wiring Terminal
- ⑥ Buckle
- ⑦ Grounding Spring Sheet
- ⑧ Fixed Wiring Harness
- ⑨ Field Power
- ⑩ Internal Bus

3.1 Network Interface

PORT1 and PORT2 are both Profinet communication port, and support switch function with 10Mbps and 100Mbps data rates, MDI/MID-X auto crossover.

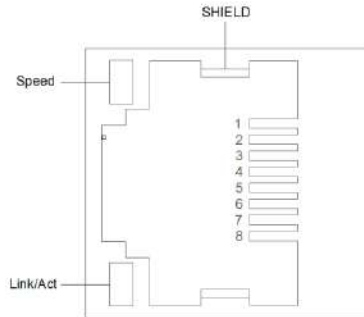

Speed: Network Speed LED (Green)

ON: 100Mbps

OFF: 10Mbps

Link/Act: Link State, Active State(Orange)

ON: Link UP

OFF: Link DOWN

Flash: Active

SHIELD: RJ45 Shield Interface

RJ45 Pin definition

Pin	Definition	Description
1	TD+	Transmitter Signal Positive
2	TD-	Transmitter Signal Negative
3	RD+	Receiver Signal Positive
4	--	--
5	--	--
6	RD-	Receiver Signal Negative
7	--	--
8	--	--

3.2 Configuration Interface

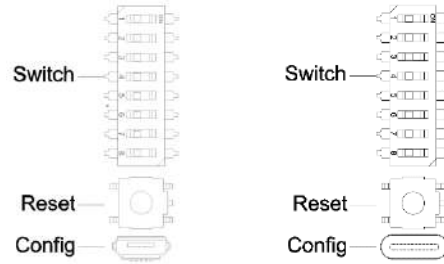

Switch: The DIP switch is used to set the name of Profinet device.

When the DIP switch value is 0, the device default name is cn8032-addr, and it could use Profinet monitor to set the device name online.

When the dial-code switch value is not 0, the device name is determined by the value of the DIP switch. The relationship between the device name and the dial value is shown in the following table:

Switch Bit Number(ON:1,OFF:0)								Switch Value	Profinet Deice Name
1	2	3	4	5	6	7	8		
0	0	0	0	0	0	0	0	0	Configured By Software (Default:cn8032-addr)
1	0	0	0	0	0	0	0	1	cn8032-1
0	1	0	0	0	0	0	0	2	cn8032-2
.
0	1	0	1	0	0	0	0	10	cn8032-10
.
0	1	1	1	1	1	1	1	254	cn8032-254
1	1	1	1	1	1	1	1	255	cn8032-255
<i>Description: Factory default dial code value is 0, the device name is cn8032-addr.</i>									

Reset: Module reset button. All parameters of the module will be restored to the default value after pressing the button for more than 5 seconds. When the Reset button is pressed, a green LED will light up in the upper left corner of the button.

Config: Configure port, a standard Micro USB/Type-C interface for configuring device parameters and firmware upgrades.

Description:device parameters can be set in Profinet IO controller configuration software.

 **WARNING**

OUT OF CONTROL

If the DIP Switch value is not 0, the DIP switch address value is the station address of the module. If the PLC communicates by assigning station address, there is a conflict between the allocated address and the DIP address. After power failure and restart, the DIP value address has a high priority, resulting in abnormal communication and module loss of control.

Failure to follow instructions specified by the manufacturer may result in serious consequences such as death, personal injury, or damage to equipment since the protection provided by the equipment may be impaired.

 **AVERTISSEMENT**

PERTE DE CONTROLE

Si la valeur du commutateur DIP n'est pas 0, la valeur de l'adresse du commutateur DIP est l'adresse de la station du module. Si le PLC communique en assignant l'adresse de la station, il y a un conflit entre l'adresse allouée et l'adresse DIP. Après une panne de courant et un redémarrage, l'adresse de valeur DIP a une priorité élevée, ce qui entraîne une communication anormale et une perte de contrôle du module.

Le fait de ne pas suivre les instructions peut entraîner une défaillance de la protection fournie par l'équipement, ce qui peut entraîner des conséquences graves, comme des blessures ou des dommages à l'équipement.

3.3 LED Indicators

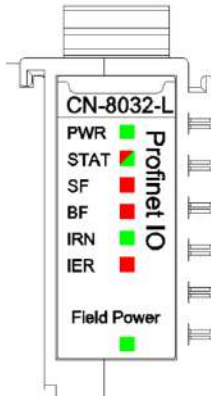

PWR Power State (GREEN)	Definition
ON	System Power Normal
OFF	System Power Failure
STAT Module State (RED/GREEN)	Definition
Double Flash (RED)	Module Soft Restart by Hard-Fault
ON(GREEN)	Operating
Single Flash (GREEN)	Stopping
Flash(2.5Hz) (RED/GREEN)	Boot Mode
Flash(10Hz) (RED/GREEN)	Firmware Update
SF System Failure (RED)	Definition
OFF	Normal
ON	System Failure, Topology Error
Flash	Led light test
Flash(10Hz)	MAC Address Error
BF Bus Failure (RED)	Definition
ON	Port1 and Port2 Link-Down
Flash(2.5Hz)	Offline mode
OFF	Online mode
Flash(10Hz)	MAC Address Error
IRN IO RUN(GREEN)	Definition
ON	IO Initialization Normal
OFF	IO Initialization Failure
IER IO Error (RED)	Definition
OFF	IO Communication Normal
Double Flash	IO Communication Failure
Field Power State (GREEN)	Definition
ON	Field Power Normal
OFF	Field Power Failure

 **WARNING****UNEXPECTED EQUIPMENT OPERATION**

By viewing the PW indicator, could determine the power supply status of a module. If the PW is steady green, the power supply is normal. Otherwise, the module cannot work properly.

When the module is initially powered on, there will be 3S for the backplane bus connection. After the backplane bus is initialized, STA is in the green steady state. If STA is in the green blinking state, it indicates that the backplane bus has not been initialized, and it needs to be powered off and restarted for re-initialization.

STA abnormal working state occurs during the normal operation of the module, please check the firmware version information of all modules, and consult ODOT technical support for details.

If a module is upgraded, check that all modules are in the normal state after the upgrade. Otherwise, an exception may occur.

Failure to follow instructions specified by the manufacturer may result in serious consequences such as death, personal injury, or damage to equipment since the protection provided by the equipment may be impaired.

 **AVERTISSEMENT****FONCTIONNEMENT INATTENDU DE L'EQUIPEMENT**

En regardant l'état de l'indicateur de PW, jugez l'état d'alimentation du module. Le feu vert PW reste allumé et l'alimentation est normale. Autrement, le module ne fonctionnera pas correctement.

Lorsque le module est alimenté initialement, il y aura 3S pour la connexion de bus de backboard. STA est un état vert permanent après l'initialisation du bus de backboard. Si STA est en état de clignotement vert, cela signifie que l'initialisation du bus de backboard n'est pas passée et doit être redémarrée hors tension et réinitialisée.

L'état de fonctionnement anormal de STA se produit pendant le fonctionnement normal du module, veuillez vérifier les informations de version du firmware de tous les modules, et consulter le support technique ODOT pour plus de détails.

Si le module a une opération de mise à niveau, après l'achèvement de la mise à niveau, le besoin de vérifier que tous les modules sont dans l'état normal avant de courir, sinon il conduira à une exception.

Le fait de ne pas suivre les instructions peut entraîner une défaillance de la protection fournie par l'équipement, ce qui peut entraîner des conséquences graves, comme des blessures ou des dommages à l'équipement.

4 Wiring

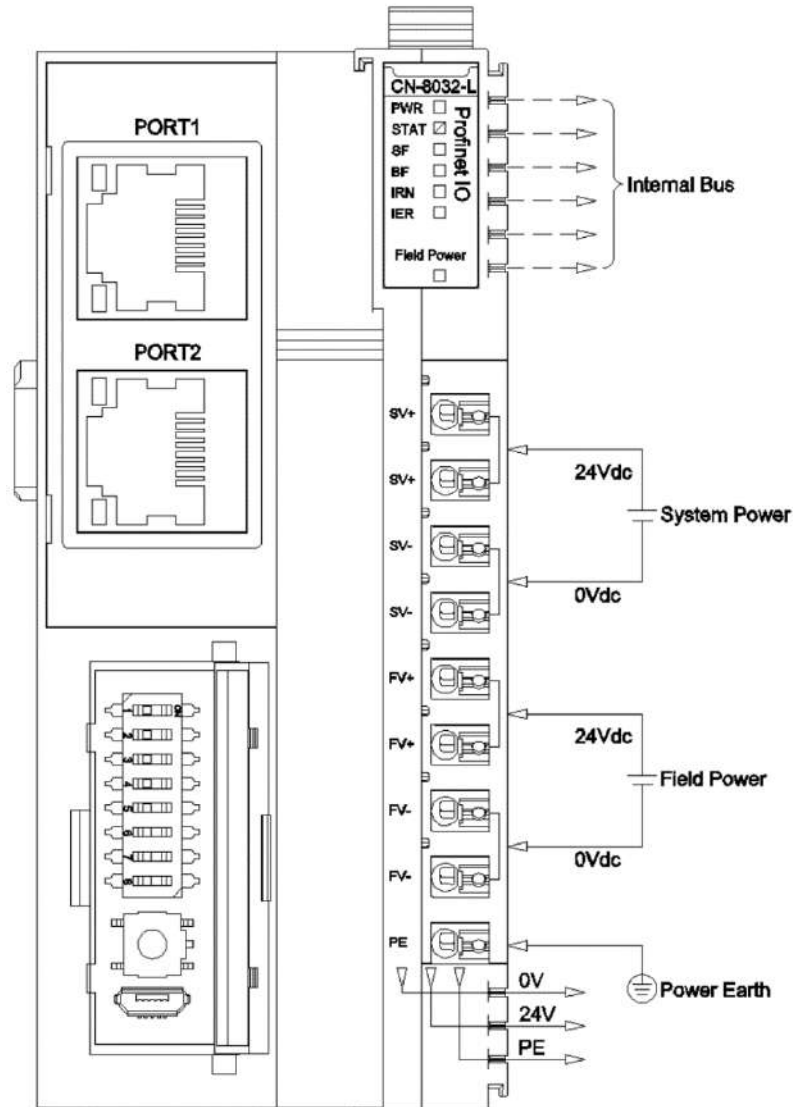

NOTICE

UNEXPECTED DEVICE OPERATION

Inside the module, two terminal blocks SV+ have been shorted, two terminal blocks SV - have been shorted, two terminal blocks FV+ have been shorted, and two terminal blocks FV - have been shorted. Externally, only one system power supply and one field power supply need to be connected.

The wire should be copper wire with a core greater than 0.2mm^2 and less than 1mm^2 , and the impedance is less than 10Ω .

Failure to follow instructions specified by the manufacturer may result in serious consequences such as death, personal injury, or damage to equipment since the protection provided by the equipment may be impaired.

5 Process data definition

5.1 Adapter process data definition

Profinet adapter itself has no input-output process data.

5.2 IO module process data mapping

The network adapter reads and writes input and output process data of IO module in real time through the internal bus, and its data mapping model is shown as follow:

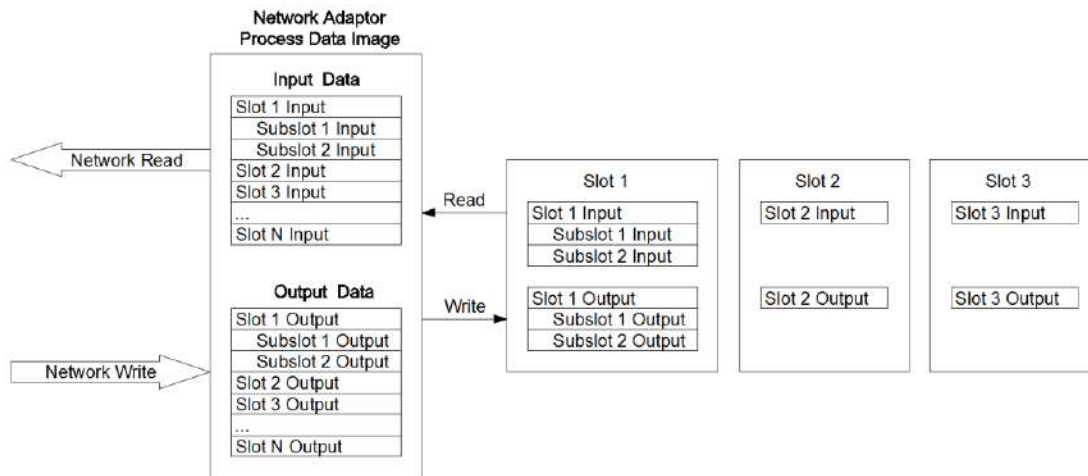

The maximum number of input bytes of the Profinet network adapter is 1440 bytes, and the maximum number of output bytes is 1440 bytes.

6 Configuration parameters definition

Configuration parameters									
Bit No	Bit 7	Bit 6	Bit 5	Bit 4	Bit 3	Bit 2	Bit 1	Bit 0	
Byte 0	Reserved					Fault Action for Output	Fault Action for Input	Source of Config Data	
Byte 1	MAC Address [0]								
Byte 2	MAC Address [1]								
Byte 3	MAC Address [2]								
Byte 4	MAC Address [3]								
Byte 5	MAC Address [4]								
Byte 6	MAC Address [5]								
Byte 7	IP Address [0]								
Byte 8	IP Address [1]								
Byte 9	IP Address [2]								
Byte 10	IP Address [3]								
Byte 11	Net Mask [0]								
Byte 12	Net Mask [1]								
Byte 13	Net Mask [2]								
Byte 14	Net Mask [3]								
Byte 15	Net Gateway [0]								
Byte 16	Net Gateway [1]								
Byte 17	Net Gateway [2]								
Byte 18	Net Gateway [3]								
Byte 19 ... Byte 82	Profinet Device Name								

Data description:

Source of Config Data: Parameter configuration mode (Default: 1)

0: Configure software

1: Field Bus

Fault Action for Input: Input fault handling mode, when IO module is offline, the adapter will process IO module input data according to this mode. (Default: 0)

0: Hold Last Input Value

1: Clearing Input Value

Fault Action for Output: Output fault handling mode, when the fieldbus is offline the adapter will process the IO module output data according to this mode. (Default: 1)

0: Hold Last Output Value

1: Clearing Output Value

MAC Address: MAC address, read-only.

IP Address: IP address, read-only.

Net Mask: Subnet mask, read-only.

Net Gateway: Gateway address, read-only.

Profinet Device Name: Profinet device name, read-only. (Device name is determined by the DIP switch)

A Dimension drawing

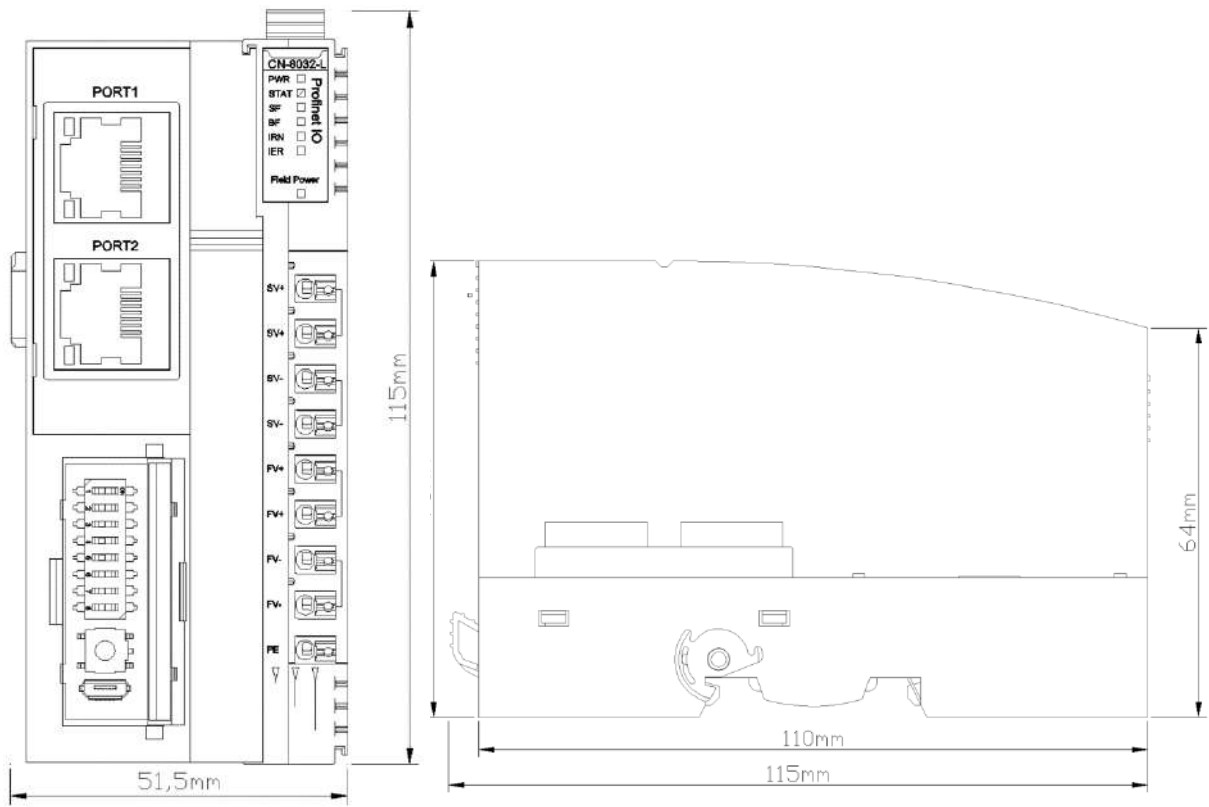

CN-8033 EtherCAT Network Adapter

1 The module overview

The CN-8033 EtherCAT I/O module supports standard EtherCAT protocol access. The adapter supports a Max. input of 1024 bytes and a Max. output of 1024 bytes. It supports 32 pcs of extended IO modules.

2 Technical Parameters

Hardware Specification	
System Power	Nominal:24VDC, Range: 20-30VDC Current: Max.2A@24VDC Protection: Reverse Protection, Overcurrent Protection
Power Consumption	110mA@24VDC
Internal BUS Supply Current	Max: 2A@5VDC
Isolation	System Power to Field Power Isolation
Field Power Supply	Power Supply: 20.4~28.8V (Nominal 24VDC)
Field Power Supply Current	Max. DC 8A
I/O Modules supported	32 pcs
Wiring	Max.: AWG 18 Min.: AWG 24
Installation	35mm DIN-Rail
Size	115*51.5*75mm
Weight	130g
Vibration Resistance	Comply with IEC 61131-2 and EC 60068-2-6
Impact resistance	Comply with IEC 61131-2 and IEC 60068-2-27
EMC Performance	Comply with IEC 61131-2 and IEC 61000-4
Environment Specification	
Operating Temperature of Horizontal Installation	-35°C~70°C
Operating Temperature of Vertical Installation	-35°C~60°C
Relative Humidity	< 95%RH (No Condensation)
Storage Temperature	-40°C~85°C
Storage Humidity	< 95%RH (No Condensation)
Manufacturing Test Temperature	-40°C~75°C
Ingress Protection Rating	IP20
EtherCAT Parameter	
Protocol	EtherCAT
Process data area	Input Max.1024 Bytes, Output Max.1024 Bytes
Network Interface	2 *RJ45
Speed	10/100Mbps, MDI/MIDX, Full-Duplex
Max.Bus Legenth	100m

 **DANGER**

THERE IS A RISK OF ELECTRIC SHOCK, EXPLOSION, OR ARC FLASH.

Disconnect all devices from power, including connected devices, before removing any covers, or installing or removing any accessories, hardware, cables, or wires, except in specific circumstances specified in the appropriate hardware guidelines for this device.

Always use a voltage sensing device with an appropriate rating to detect a power outage at the appropriate place and time, as instructed.

Replace and tighten all covers, accessories, hardware, cables, and wires, and confirm that the ground connection is correct before powering on the device.

When operating this equipment and related products, the specified voltage must be used.

Failure to follow instructions specified by the manufacturer may result in serious consequences such as death, personal injury, or damage to equipment since the protection provided by the equipment may be impaired.

3 Hardware Interface

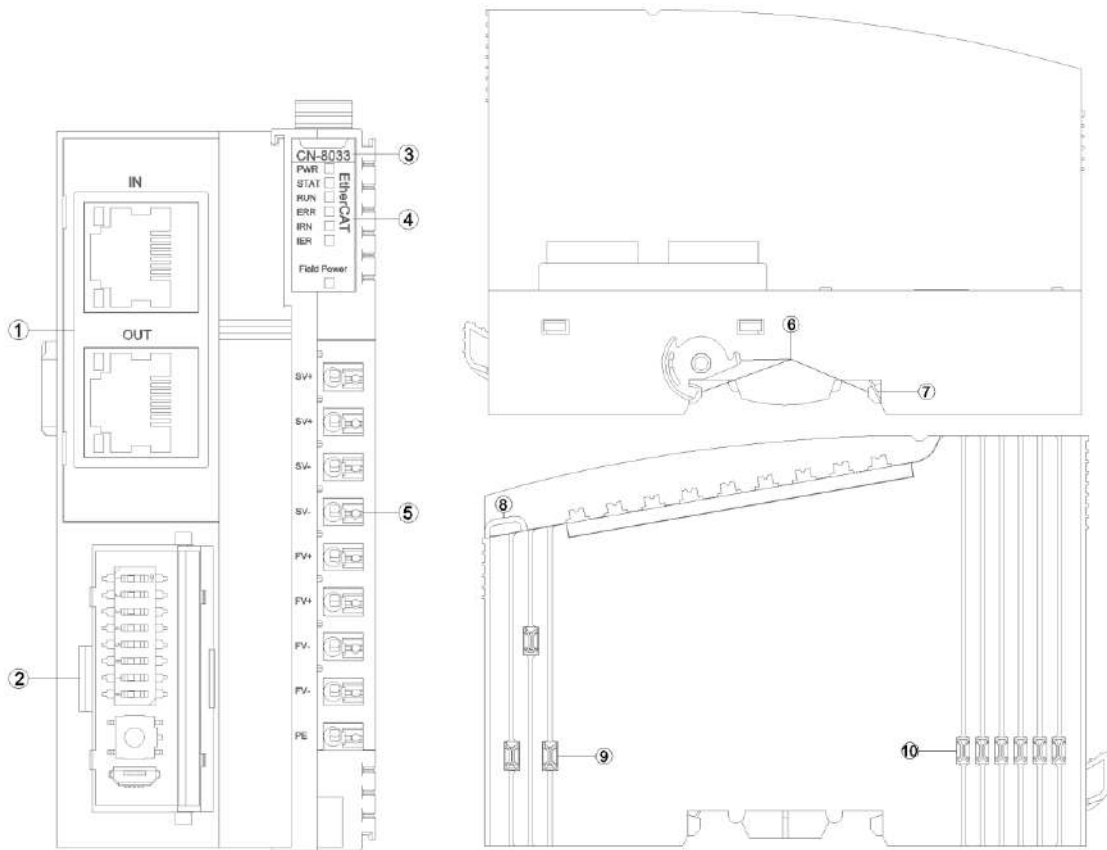

- ① Network Interface
- ② Config Interface
- ③ Module Type
- ④ LED Indicator
- ⑤ Wiring Terminal
- ⑥ Buckle
- ⑦ Grounding Spring Sheet
- ⑧ Fixed Wiring Harness
- ⑨ Field Power
- ⑩ Internal Bus

3.1 Network Interface

IN is the input interface of EtherCAT, OUT is the output interface of EtherCAT, and it support switch function with 10Mbps and 100Mbps data rates, MDI/MID-X auto crossover.

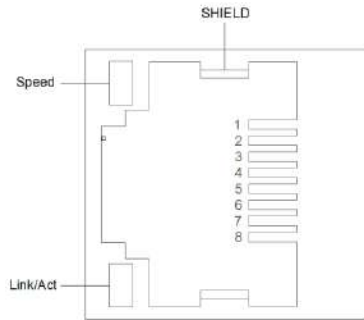

Speed: Network Speed LED Indicator (Green)

ON:100M

OFF:10M

Link/Act: Link State, Active State (Orange)

ON: Link UP

OFF: Link DOWN

Flash: Active

SHIELD: RJ45 Shield Interface

RJ45 Pin definition

Pin	Definition	Description
1	TD+	Transmitter Signal Positive
2	TD-	Transmitter Signal Negative
3	RD+	Receiver Signal Positive
4	--	--
5	--	--
6	RD-	Receiver Signal Positive
7	--	--
8	--	--

3.2 Configuration Interface

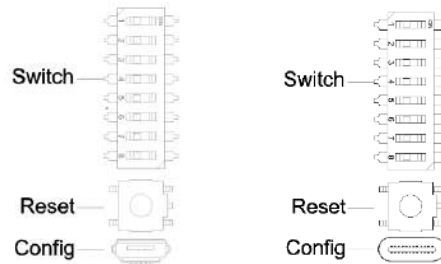

Switch: station alias configuration

When the dial - code switch value is not 0, the dial - code value is station alias, after dialing the code, the site alias will not take effect until the power is turned off and restarted. When the dial - code switch value is 0, using the site alias set by the PLC Master or the site alias in EEPROM memory.

The relationship between the site alias and the dial - code switch value is shown in the following table:

Dial - code switch pin number (ON:1, OFF:0)								Dial - code switch value	Site Alias
1	2	3	4	5	6	7	8		
0	0	0	0	0	0	0	0	0	0
1	0	0	0	0	0	0	0	1	1
0	1	0	0	0	0	0	0	2	2
.
0	1	0	1	0	0	0	0	10	10
.
0	1	1	1	1	1	1	1	254	254
1	1	1	1	1	1	1	1	255	255

Reset: Module reset button. All parameters of the module will be restored to the default value after pressing the button for more than 5 seconds. When the Reset button is pressed, a green LED will light up in the upper left corner of the button.

Config: Configure port, a standard Micro USB/Type-C interface for configuring device parameters and firmware upgrades.

⚠ WARNING
OUT OF CONTROL

If the DIP Switch value is not 0, the DIP switch address value is the station address of the module. If the PLC communicates by assigning station address, there is a conflict between the allocated address and the DIP address. After power failure and restart, the DIP value address has a high priority, resulting in abnormal communication and module loss of control.

Failure to follow instructions specified by the manufacturer may result in serious consequences such as death, personal injury, or damage to equipment since the protection provided by the equipment may be impaired.

AVERTISSEMENT

PERTE DE CONTROLE

Si la valeur du commutateur DIP n'est pas 0, la valeur de l'adresse du commutateur DIP est l'adresse de la station du module. Si le PLC communique en assignant l'adresse de la station, il y a un conflit entre l'adresse allouée et l'adresse DIP. Après une panne de courant et un redémarrage, l'adresse de valeur DIP a une priorité élevée, ce qui entraîne une communication anormale et une perte de contrôle du module.

Le fait de ne pas suivre les instructions peut entraîner une défaillance de la protection fournie par l'équipement, ce qui peut entraîner des conséquences graves, comme des blessures ou des dommages à l'équipement.

3.3 LED Indicator

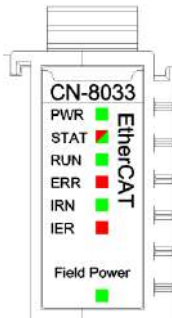

PWR - Power State (RED)	Definition
ON	System Power Normal
OFF	System Power Failure
STAT - Module State LED (RED/GREEN)	Definition
Double Flash (RED)	Module abnormal, has been softly restarted
ON(GREEN)	Operating
Single Flash (GREEN)	Stopping
Flash(2.5Hz) (RED/GREEN)	Upgrading Mode
Flash(10Hz) (RED/GREEN)	Firmware Updating
RUN - Bus running Indicator	Definition
ON	Operating
OFF	Initialization state
Flash(10Hz)	During boot or in the state of BootStrap
Flash(2.5Hz)	Pre-Operational State
Single Flash	Safe Operating State
ERR - Bus Error LED	Definition
OFF	No Failure
ON	Application control failure
Flash(10Hz)	Startup Errors
Flash(2.5Hz)	Invalid Configuration
Single Flash	Local error, unsolicited state switch
Double Flash	Watchdog Error
IRN - IO RUN(GREEN)	Definition
ON	IO Initialization Normal
OFF	IO Initialization Failure
IER - IO Error (RED)	Definition
OFF	IO Communication Normal
Double flash	IO Communication Failure
Field Power - Indicator	Definition
On	On-site power supply normal
Off	On-site power supply abnormal

WARNING

UNEXPECTED EQUIPMENT OPERATION

By viewing the PW indicator, could determine the power supply status of a module. If the PW is steady green, the power supply is normal. Otherwise, the module cannot work properly.

When the module is initially powered on, there will be 3S for the backplane bus connection. After the backplane bus is initialized, STA is in the green steady state. If STA is in the green blinking state, it indicates that the backplane bus has not been initialized, and it needs to be powered off and restarted for re-initialization.

STA abnormal working state occurs during the normal operation of the module, please check the firmware version information of all modules, and consult ODOT technical support for details.

If a module is upgraded, check that all modules are in the normal state after the upgrade. Otherwise, an exception may occur.

Failure to follow instructions specified by the manufacturer may result in serious consequences such as death, personal injury, or damage to equipment since the protection provided by the equipment may be impaired.

AVERTISSEMENT

FONCTIONNEMENT INATTENDU DE L'EQUIPEMENT

En regardant l'état de l'indicateur de PW, jugez l'état d'alimentation du module. Le feu vert PW reste allumé et l'alimentation est normale. Autrement, le module ne fonctionnera pas correctement.

Lorsque le module est alimenté initialement, il y aura 3S pour la connexion de bus de backboard. STA est un état vert permanent après l'initialisation du bus de backboard. Si STA est en état de clignotement vert, cela signifie que l'initialisation du bus de backboard n'est pas passée et doit être redémarrée hors tension et réinitialisée.

L'état de fonctionnement anormal de STA se produit pendant le fonctionnement normal du module, veuillez vérifier les informations de version du firmware de tous les modules, et consulter le support technique ODOT pour plus de détails.

Si le module a une opération de mise à niveau, après l'achèvement de la mise à niveau, le besoin de vérifier que tous les modules sont dans l'état normal avant de courir, sinon il conduira à une exception.

Le fait de ne pas suivre les instructions peut entraîner une défaillance de la protection fournie par l'équipement, ce qui peut entraîner des conséquences graves, comme des blessures ou des dommages à l'équipement.

4 Wiring

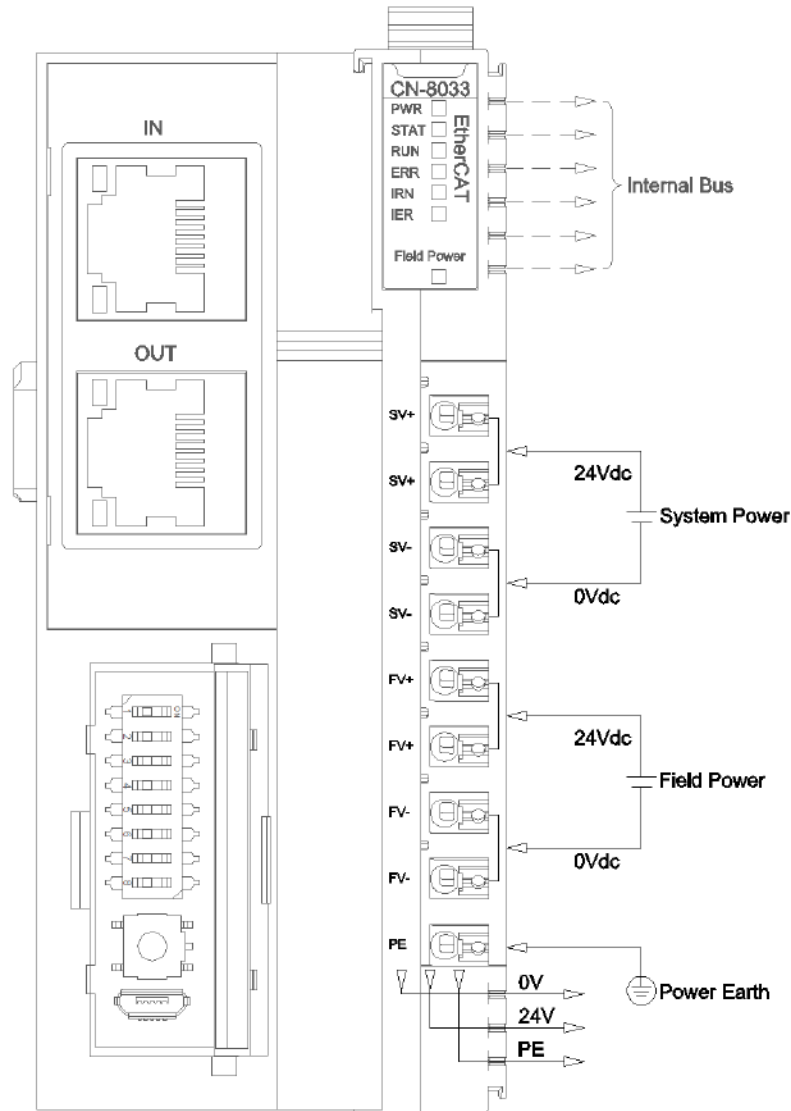

NOTICE

UNEXPECTED DEVICE OPERATION

Inside the module, two terminal blocks SV+ have been shorted, two terminal blocks SV - have been shorted, two terminal blocks FV+ have been shorted, and two terminal blocks FV - have been shorted. Externally, only one system power supply and one field power supply need to be connected.

The wire should be copper wire with a core greater than 0.2mm^2 and less than 1mm^2 , and the impedance is less than 10Ω .

Failure to follow instructions specified by the manufacturer may result in serious consequences such as death, personal injury, or damage to equipment since the protection provided by the equipment may be impaired.

5 Process data definition

5.1 Adapter process data definition

EtherCAT adapter itself has no input/output process data.

5.2 IO module process data mapping

The network adapter reads and writes input and output process data of IO module in real time through the internal bus, and its data mapping model is shown as follow:

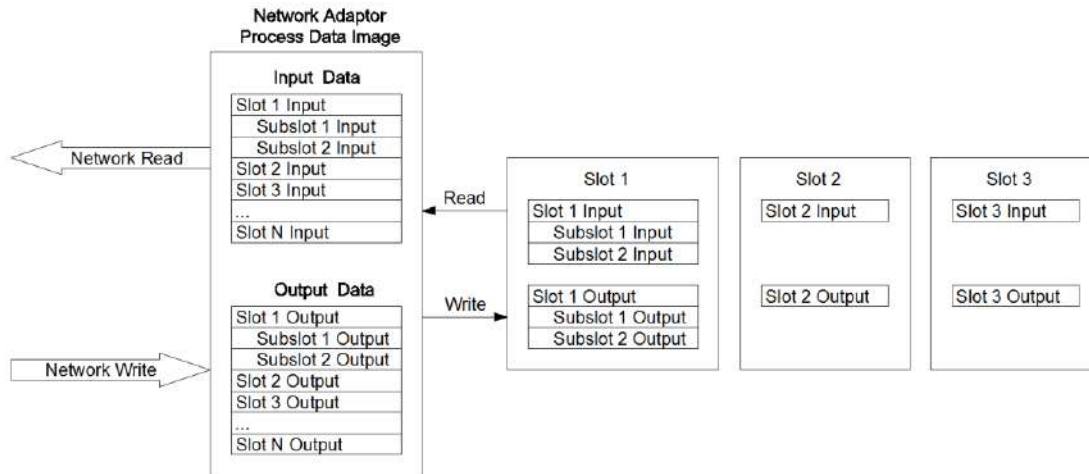

The maximum number of input bytes of the EtherCAT network adapter is 1024 bytes, and the maximum number of output bytes is 1024 bytes.

6 Configuration parameters definition

Configuration parameters								
Bit No	Bit 7	Bit 6	Bit 5	Bit 4	Bit 3	Bit 2	Bit 1	Bit 0
Byte 0	Reserved					Fault Action for Output	Fault Action for Input	Source of Config Data

Data description:

Source of Config Data: Parameter configuration mode (Default: 0)

- 0: Configured software configuration
- 1: Field Bus configuration

Fault Action for Input: Input fault handling mode, when IO module is offline, the adapter will process IO module input data according to this mode. (Default: 0)

- 0: Hold Last Input Value
- 1: Clearing Input Value

Fault Action for Output: Output fault handling mode, when the fieldbus is offline the adapter will process the IO module output data according to this mode. (Default: 0)

- 0: Hold Last Output Value
- 1: Clearing Output Value

A Dimension drawing

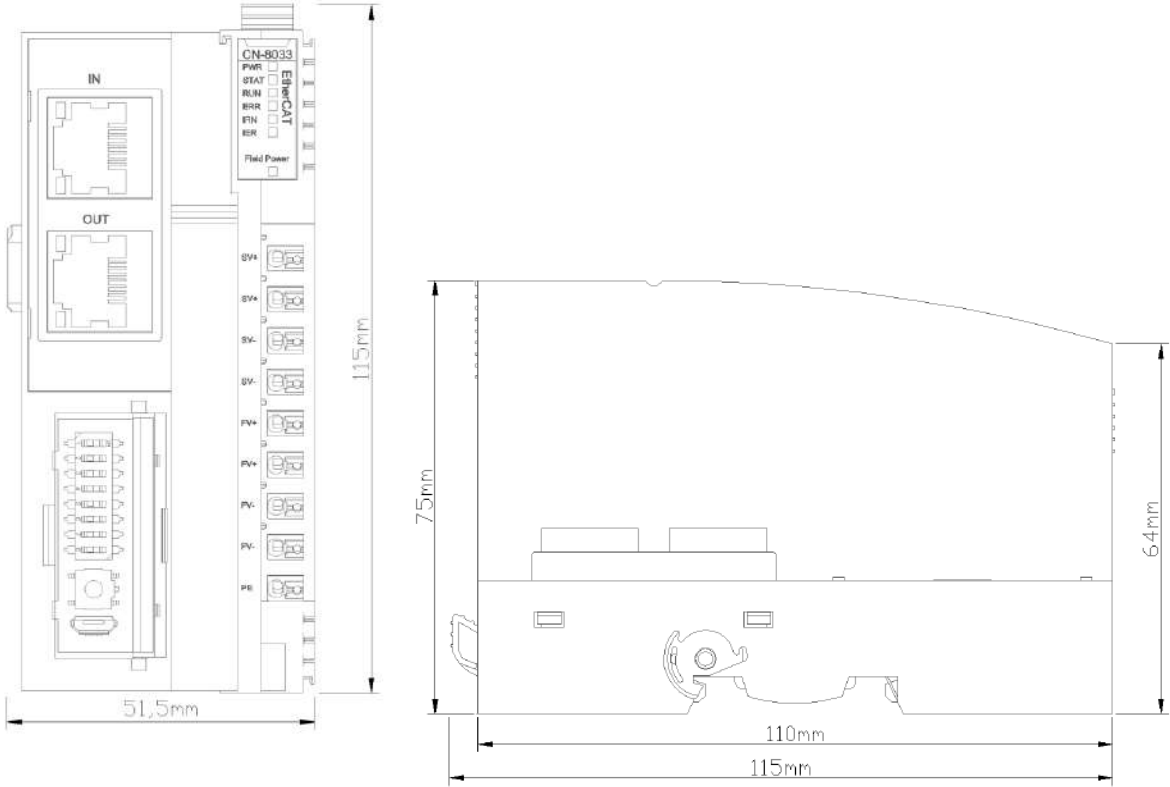

CN-8034 Ethernet/IP Network Adapter

1 The module overview

The CN-8034 Ethernet/IP I/O module supports standard Ethernet/IP protocol access. The adapter supports a Max. input of 504 bytes and a Max. output of 504 bytes. It supports 32 pcs of extended IO modules.

2 Technical Parameters

Hardware Specification	
System Power	Nominal:24VDC, Range: 20-30VDC Current: Max.2A@24VDC Protection: Reverse Protection, Overcurrent Protection
Power Consumption	110mA@24VDC
Internal BUS Supply Current	Max.2A@5VDC
Isolation	System Power to Field Power Isolation
Field Power Supply	Power Supply: 20.4~28.8V (Nominal 24VDC)
Field Power Supply Current	Max. DC 8A
I/O Modules supported	32 pcs
Wiring	Max.: AWG 18 Min.: AWG 24
Installation	35mm DIN-Rail
Size	115*51.5*75mm
Weight	130g
Environment Specification	
Operating Temperature of Horizontal Installation	-35°C~70°C
Operating Temperature of Vertical Installation	-35°C~60°C
Relative Humidity	< 95%RH (No Condensation)
Storage Temperature	-40°C~85°C
Storage Humidity	< 95%RH (No Condensation)
Manufacturing Test Temperature	-40°C~75°C
Ingress Protection Rating	IP20
Ethernet/IP Parameter	
Protocol	Ethernet/IP
Max. input length	504 Bytes per assembly instance
Max. output length	504 Bytes per assembly instance
Max. no. of explicit message connections	10
Max. no. of implicit message connections	5
Max. no. of CIP connections	10
Network Interface	2*RJ45
Speed	10/100Mbps, MDI/MIDX, Full-Duplex
Max.Bus Legenth	100m

 **DANGER**

THERE IS A RISK OF ELECTRIC SHOCK, EXPLOSION, OR ARC FLASH.

Disconnect all devices from power, including connected devices, before removing any covers, or installing or removing any accessories, hardware, cables, or wires, except in specific circumstances specified in the appropriate hardware guidelines for this device.

Always use a voltage sensing device with an appropriate rating to detect a power outage at the appropriate place and time, as instructed.

Replace and tighten all covers, accessories, hardware, cables, and wires, and confirm that the ground connection is correct before powering on the device.

When operating this equipment and related products, the specified voltage must be used.

Failure to follow instructions specified by the manufacturer may result in serious consequences such as death, personal injury, or damage to equipment since the protection provided by the equipment may be impaired.

3 Hardware Interface

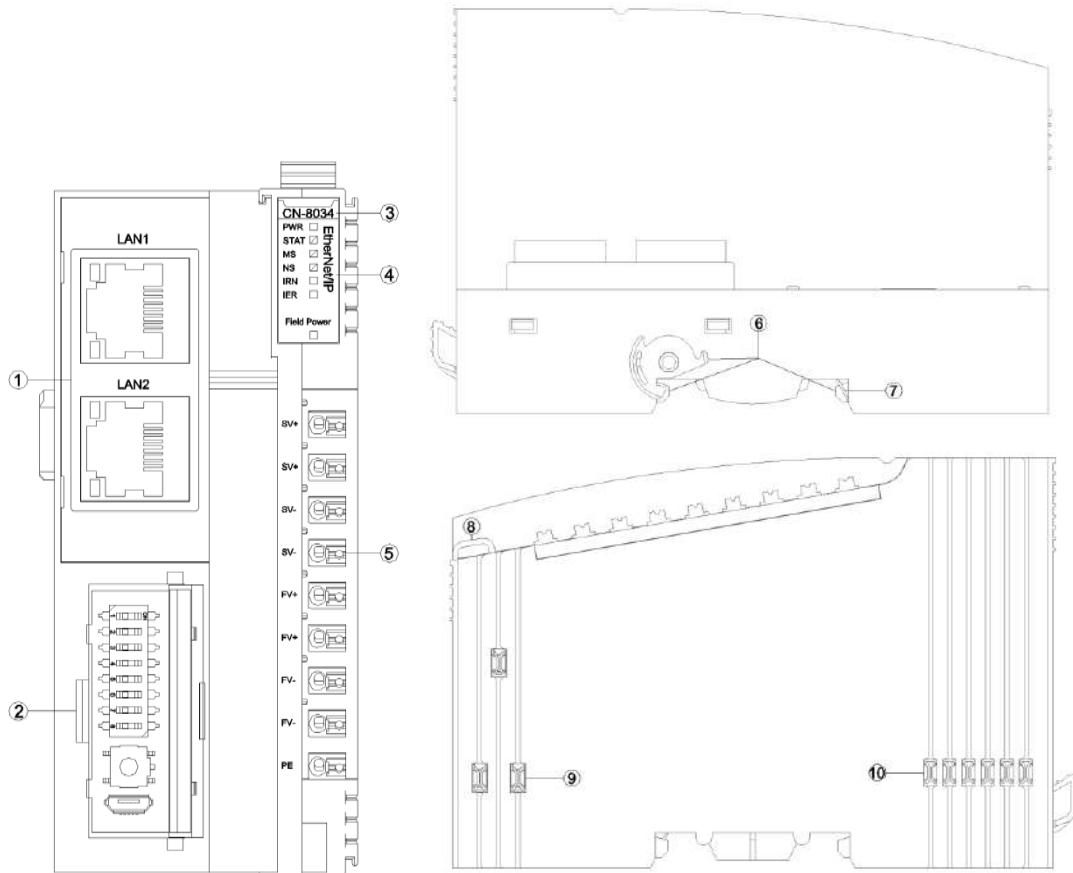

- ① Network Interface
- ② Config Interface
- ③ Module Type
- ④ LED Indicator
- ⑤ Wiring Terminal
- ⑥ Buckle
- ⑦ Grounding Spring Sheet
- ⑧ Fixed Wiring Harness
- ⑨ Field Power
- ⑩ Internal Bus

3.1 Network Interface

LAN1/LAN2 are the Ethernet/IP Ethernet port which support switch functions, 10Mbps and 100Mbps data rates, MDI/MID-X auto crossover.

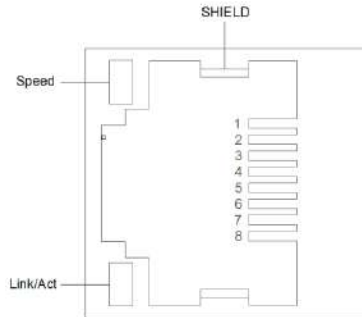

Speed: Network Speed LED Indicator (Green)

ON:100M

OFF:10M

Link/Act: Link State, Active State (Orange)

ON:Link UP

OFF:Link DOWN

Flash:Active

SHIELD: RJ45 Shield Interface

RJ45 Pin definition

Pin	Definition	Description
1	TD+	Transmitter Signal Positive
2	TD-	Transmitter Signal Negative
3	RD+	Receiver Signal Positive
4	--	--
5	--	--
6	RD-	Receiver Signal Positive
7	--	--
8	--	--

3.2 Configuration Interface

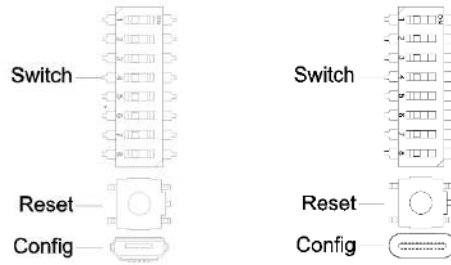

Switch: the DIP switch is used for setting the IP address (the default IP address is 192.168.1.200).

When the dial value is 0, all 4 bytes of the IP address are configured by the software or use the default IP address (192.168.1.200).

When the dial code value is not 0, the last byte of the IP address is determined by the dial code value, and the first three bytes could be configured by the software or use the default address (192.168.1).

The relationship between IP address and dial code value is shown as below:

Dial - code Switch Bit Number (ON: 1, OFF: 0)								Dial - code switch value	IP Address
1	2	3	4	5	6	7	8		
0	0	0	0	0	0	0	0	0	Configured by software (or default)
1	0	0	0	0	0	0	0	1	x.x.x.1
0	1	0	0	0	0	0	0	2	x.x.x.2
1	1	0	0	0	0	0	0	3	x.x.x.3
.
.
0	1	1	1	1	1	1	1	254	x.x.x.254
1	1	1	1	1	1	1	1	255	x.x.x.255

Note: The default IP address after device reset is 192.168.1.200

Reset: Module reset button, long pressing the button for more than 5 seconds and all parameters of the module will be restored to the default value. When the Reset button is activated, a green indicator will light up in the upper left corner of the button.

Config: Configure port, a standard Micro USB/Type-C interface for configuring device parameters and firmware upgrades.

 **WARNING**

OUT OF CONTROL

If the DIP Switch value is not 0, the DIP switch address value is the station address of the module. If the PLC communicates by assigning station address, there is a conflict between the allocated address and the DIP address. After power failure and restart, the DIP value address has a high priority, resulting in abnormal communication and module loss of control.

Failure to follow instructions specified by the manufacturer may result in serious consequences such as death, personal injury, or damage to equipment since the protection provided by the equipment may be impaired.

 **AVERTISSEMENT**

PERTE DE CONTROLE

Si la valeur du commutateur DIP n'est pas 0, la valeur de l'adresse du commutateur DIP est l'adresse de la station du module. Si le PLC communique en assignant l'adresse de la station, il y a un conflit entre l'adresse allouée et l'adresse DIP. Après une panne de courant et un redémarrage, l'adresse de valeur DIP a une priorité élevée, ce qui entraîne une communication anormale et une perte de contrôle du module.

Le fait de ne pas suivre les instructions peut entraîner une défaillance de la protection fournie par l'équipement, ce qui peut entraîner des conséquences graves, comme des blessures ou des dommages à l'équipement.

3.3 LED indicator

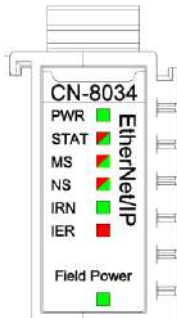

PWR Power State (RED)	Definition
ON	System Power Normal
OFF	System Power Failure
STAT Module State (RED/GREEN)	Definition
Double Flash (RED)	Module Soft Restarted by Hard-Fault
ON(GREEN)	Running
Single Flash (GREEN)	Stopping
Flash(2.5Hz) (RED/GREEN)	Boot Mode
Flash(10Hz) (RED/GREEN)	Firmware Updating
MS module state indicator	Definition
ON(GREEN)	Module running state correct
Flash(1Hz) (GREEN)	Module not configured
Flash(GREEN/RED/GREEN)	Module power on self-test state
Flash(1Hz) (RED)	The module detects a recoverable failure state
Red(GREEN)	The module detects an unrecoverable failure status
OFF	Module power off
NS network state indicator	Definition
ON(GREEN)	The connection has been established.IP address configuration completed, at least one CIP connection established, the master connection does not time out.
Flash(1Hz) (GREEN)	The connection not established.IP address configuration completed, CIP connection not established, the master connection does not time out.
Flash(GREEN/RED/OFF)	Module power on self-test state.
Flash(1Hz) (RED)	The connection times out, IP address configuration completed, the master connection times out.
ON(RED)	Duplicate IP, the IP address is already in use.
OFF	Not powered, no IP address.
IRN - IO RUN(GREEN)	Definition
ON	IO Initialization Normal
OFF	IO Initialization Failure
IER - IO Error (RED)	Definition

OFF	IO Communication Normal
Double flash	IO Communication Failure
Field Power - Indicator	Definition
ON	On-site power supply normal
OFF	On-site power supply abnormal

WARNING

UNEXPECTED EQUIPMENT OPERATION

By viewing the PW indicator, could determine the power supply status of a module. If the PW is steady green, the power supply is normal. Otherwise, the module cannot work properly.

When the module is initially powered on, there will be 3S for the backplane bus connection. After the backplane bus is initialized, STA is in the green steady state. If STA is in the green blinking state, it indicates that the backplane bus has not been initialized, and it needs to be powered off and restarted for re-initialization.

STA abnormal working state occurs during the normal operation of the module, please check the firmware version information of all modules, and consult ODOT technical support for details.

If a module is upgraded, check that all modules are in the normal state after the upgrade. Otherwise, an exception may occur.

Failure to follow instructions specified by the manufacturer may result in serious consequences such as death, personal injury, or damage to equipment since the protection provided by the equipment may be impaired.

AVERTISSEMENT

FONCTIONNEMENT INATTENDU DE L'EQUIPEMENT

En regardant l'état de l'indicateur de PW, jugez l'état d'alimentation du module. Le feu vert PW reste allumé et l'alimentation est normale. Autrement, le module ne fonctionnera pas correctement.

Lorsque le module est alimenté initialement, il y aura 3S pour la connexion de bus de backboard. STA est un état vert permanent après l'initialisation du bus de backboard. Si STA est en état de clignotement vert, cela signifie que l'initialisation du bus de backboard n'est pas passée et doit être redémarrée hors tension et réinitialisée.

L'état de fonctionnement anormal de STA se produit pendant le fonctionnement normal du module, veuillez vérifier les informations de version du firmware de tous les modules, et consulter le support technique ODOT pour plus de détails.

Si le module a une opération de mise à niveau, après l'achèvement de la mise à niveau, le besoin de vérifier que tous les modules sont dans l'état normal avant de courir, sinon il conduira à une exception.

Le fait de ne pas suivre les instructions peut entraîner une défaillance de la protection fournie par l'équipement, ce qui peut entraîner des conséquences graves, comme des blessures ou des dommages à l'équipement.

4 Wiring

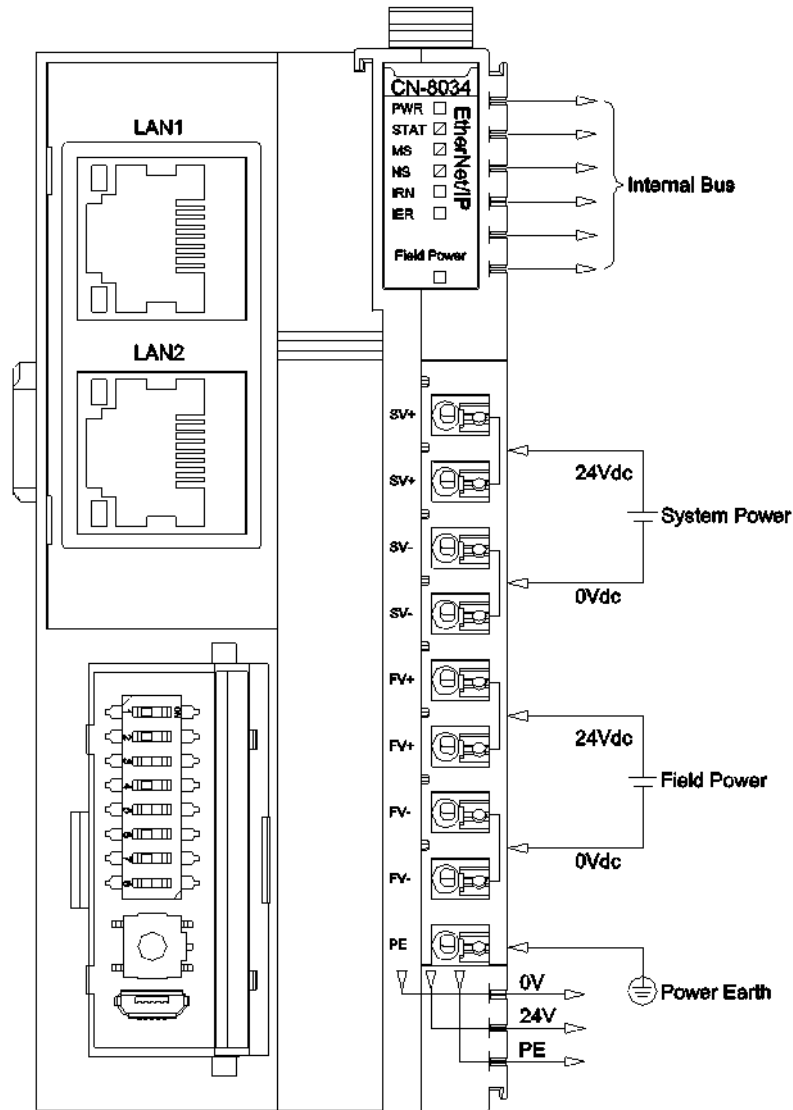

NOTICE

UNEXPECTED DEVICE OPERATION

Inside the module, two terminal blocks SV+ have been shorted, two terminal blocks SV - have been shorted, two terminal blocks FV+ have been shorted, and two terminal blocks FV - have been shorted. Externally, only one system power supply and one field power supply need to be connected.

The wire should be copper wire with a core greater than 0.2mm² and less than 1mm², and the impedance is less than 10Ω.

Failure to follow instructions specified by the manufacturer may result in serious consequences such as death, personal injury, or damage to equipment since the protection provided by the equipment may be impaired.

5 Process data definition

5.1 Adapter process data definition

Ethernet/IP adapter itself has no input/output process data.

5.2 IO module process data mapping

The network adapter reads and writes input and output process data of IO module in real time through the internal bus, and its data mapping model is shown as follow:

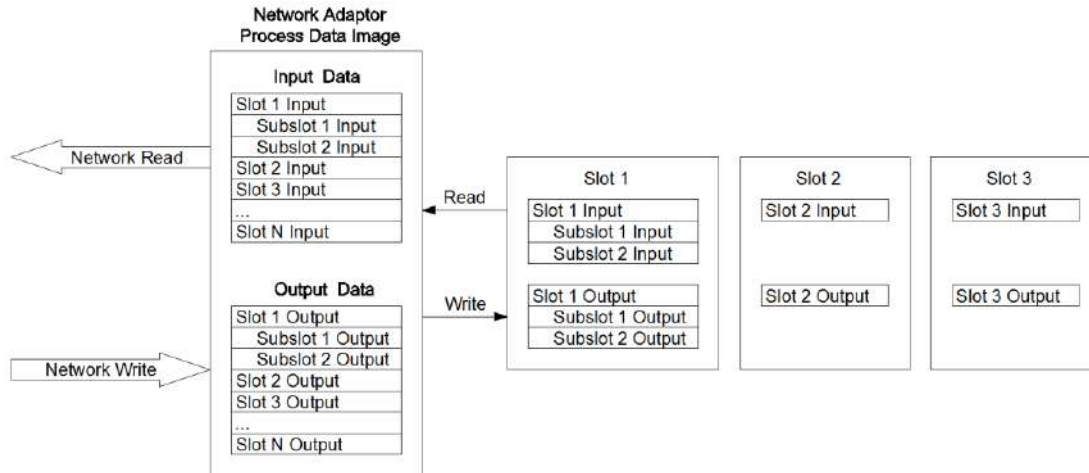

The maximum number of input bytes of the Ethernet/IP network adapter is 504 bytes, and the maximum number of output bytes is 504 bytes.

6 Configuration parameters definition

Configuration parameters								
Bit No	Bit 7	Bit 6	Bit 5	Bit 4	Bit 3	Bit 2	Bit 1	Bit 0
Byte 0	Reserved			O-->T Transfer Format	T-->O Transfer Format	Fault Action for Output	Fault Action for Input	Source of Config Data
Byte 1	MAC Address [0]							
Byte 2	MAC Address [1]							
Byte 3	MAC Address [2]							
Byte 4	MAC Address [3]							
Byte 5	MAC Address [4]							
Byte 6	MAC Address [5]							
Byte 7	IP Address [0]							
Byte 8	IP Address [1]							
Byte 9	IP Address [2]							
Byte 10	IP Address [3]							
Byte 11	Net Mask [0]							
Byte 12	Net Mask [1]							
Byte 13	Net Mask [2]							
Byte 14	Net Mask [3]							
Byte 15	Net Gateway [0]							
Byte 16	Net Gateway [1]							
Byte 17	Net Gateway [2]							
Byte 18	Net Gateway [3]							
Byte 19	T-->O Size (Bytes)							
Byte 20								
Byte 21	O-->T Size (Bytes)							
Byte 22								

Data description:

Source of Config Data: Parameter configuration mode (Default: 0)

0: Configured software configuration

1: Field Bus configuration

Fault Action for Input: Input fault handling mode, when IO module is offline, the adapter will process IO module input data according to this mode. (Default: 0)

0: Hold Last Input Value

1: Clearing Input Value

Fault Action for Output: Output fault handling mode, when the fieldbus is offline the adapter will process the IO module output data according to this mode. (Default: 0)

0: Hold Last Output Value

1: Clearing Output Value

T-->O Transfer Format: T-->O Input conversion format, read only.

O-->T Transfer Format: O-->T Output conversion format, read only.

MAC Address: MAC address, read only.

IP Address: IP Address

Subnet Mask

Gateway Address

T-->O Size (Bytes): O-->T length (Bytes) , read only.

O-->T Size (Bytes): O-->T length (Bytes) , read only.

A Dimension drawing

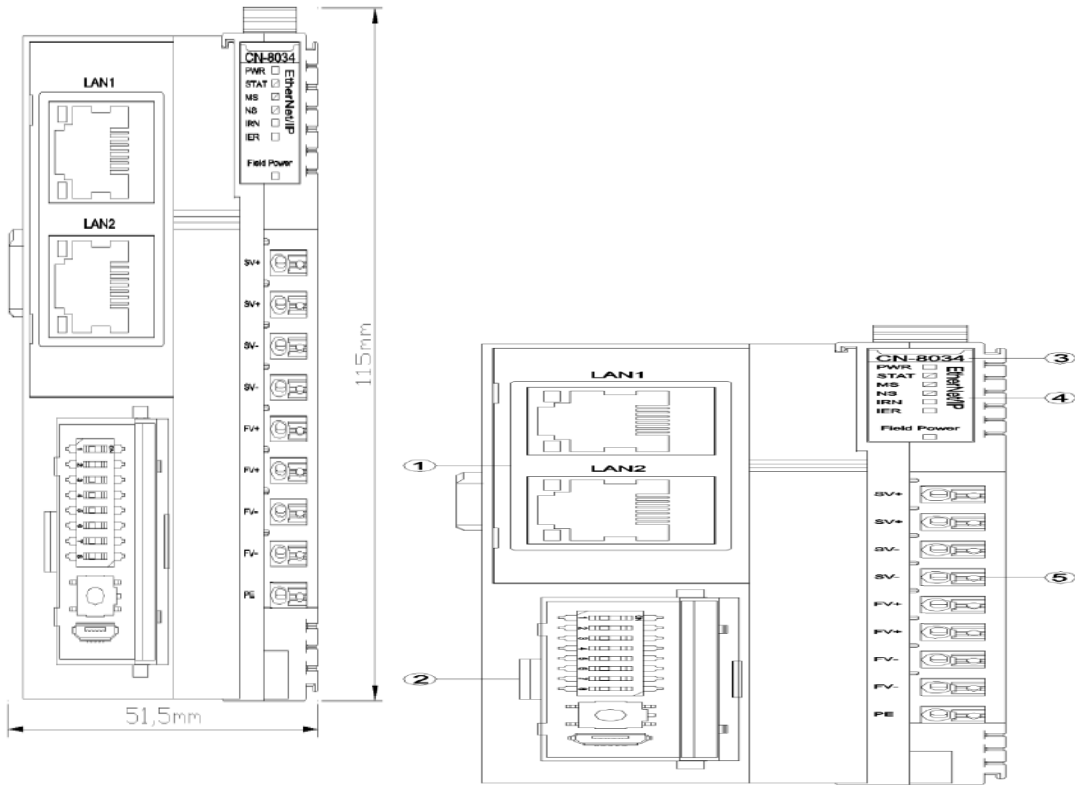

CN-8037 CC-Link IEFB Network Adapter

1 Module overview

CN-8037 CC-Link IE Field Network Basic Network Adapter supports standard CC-Link IE Field Network Basic communication and remote equipment stations which could up to 16 stations at most. Its maximum transmission distance could be 100m. The maximum RX/RX capacity is 1024 bits, and the RWr/RWw capacity is up to 512 characters. Ethernet supports the cascade function of dual-port switches, with a communication rate of 100Mbps. The number of stations can be automatically calculated according to the number of IO modules in actual configuration, and the communication status of IO modules can be monitored in real time.

2 Technical parameter

Hardware Parameters	
System Power	Nominal:24VDC, Range: 20-30VDC Current: Max.2A@24VDC Protection: Reverse Protection, Overcurrent Protection
Module Power Consumption	60mA@24VDC
Internal Bus Supply Current	Max.: 2.5A@5VDC
Isolation	System power to field power is isolated The field power supply is isolated from the system power supply at AC 500V The field power supply is isolated from PE at AC 500V The system power supply is isolated from PE at AC 500V
Power Supply	Power supply: 20.4~28.8V (24VDC nominal) Protection: Reverse Protection
Field Power Current	Max. DC 8A
I/O Modules Supported	32 pcs
Wiring	Max.: AWG 18 Min.: AWG 24
Installation	35mm DIN-Rail
Size	115*51.5*75mm
Weight	130g
Vibration Resistance	Comply with IEC 61131-2 and IEC 60068-2-6
Impact Resistance	Comply with IEC 61131-2 and IEC 60068-2-27
EMC Performance	Comply with IEC 61131-2 and IEC 61000-4
Environmental Parameters	
Operating Temperature of Horizontal Installation	-35°C~70°C
Operating Temperature of Vertical Installation	-35°C~60°C
Relative Humidity	< 95%RH (No Condensation)
Storage Temperature	-40°C~85°C
Storage Humidity	< 95%RH (No Condensation)
Manufacturing Test Temperature	-40°C~75°C
Ingress Protection Rating	IP20
CC-Link IE FIELD BASIC Parameters	
Protocol	CC-Link IE FIELD BASIC
Station Type	Remote equipment station
Number of Logical Stations Occupied	1~16 (1 station has 64 bits RY data, 32 words RWw data, 64 bits RX data, and 32 words RWr data)
I/O Data Capacity	Maximum number of cyclic RY data: 128 bytes (1024 bits) Maximum number of cyclic RX data: 128 bytes (1024 bits) Maximum number of cyclic RWw data: 512 words (16 bits) Maximum number of cyclic RWr data: 512 words (16 bits)
Network Interfaces	2*RJ45

Connection Rate	100Mbit/s
Transmission Distance	100m (distance from station)
IP Address Settings	DIP switch or configured by IO Config software

 **DANGER**

THERE IS A RISK OF ELECTRIC SHOCK, EXPLOSION, OR ARC FLASH.

Disconnect all devices from power, including connected devices, before removing any covers, or installing or removing any accessories, hardware, cables, or wires, except in specific circumstances specified in the appropriate hardware guidelines for this device.

Always use a voltage sensing device with an appropriate rating to detect a power outage at the appropriate place and time, as instructed.

Replace and tighten all covers, accessories, hardware, cables, and wires, and confirm that the ground connection is correct before powering on the device.

When operating this equipment and related products, the specified voltage must be used.

Failure to follow instructions specified by the manufacturer may result in serious consequences such as death, personal injury, or damage to equipment since the protection provided by the equipment may be impaired.

3 Hardware interface

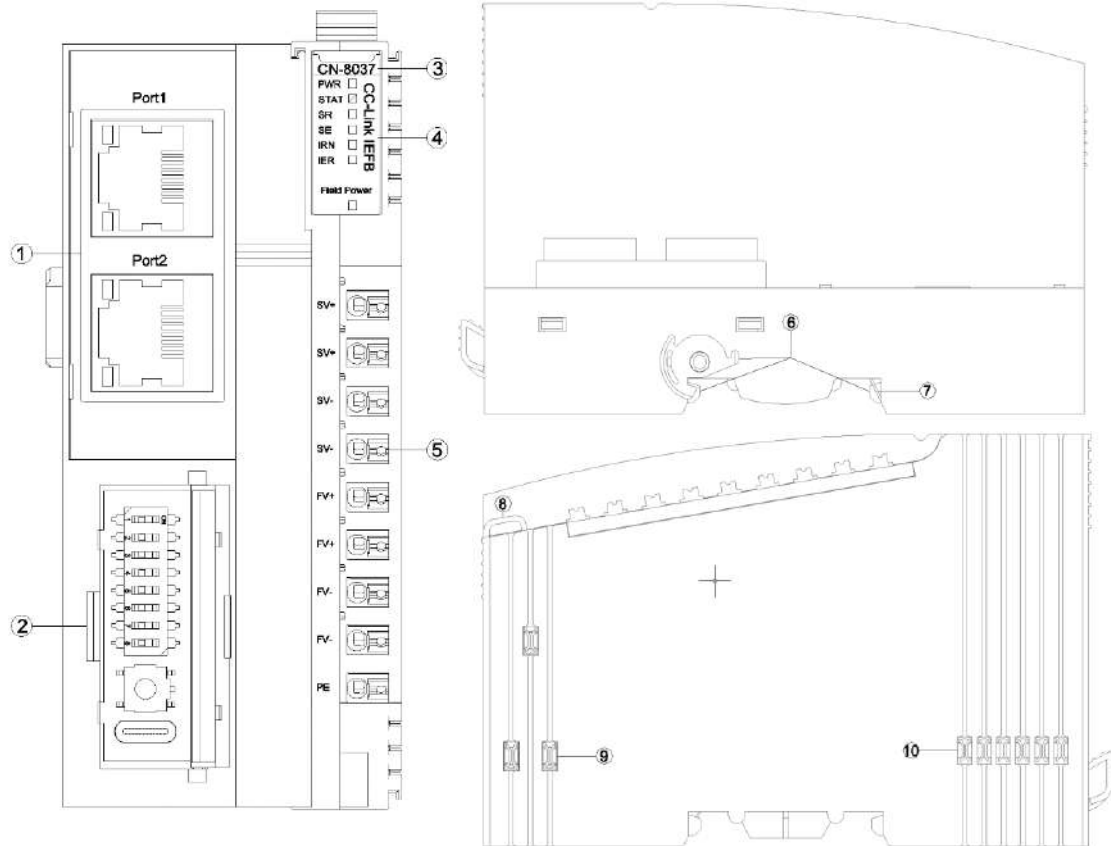

- ① Network interface
- ② Config interface
- ③ Module type
- ④ LED indicator
- ⑤ Wiring Terminal
- ⑥ Buckle
- ⑦ Grounding Spring Sheet
- ⑧ Fixed Wiring Harness
- ⑨ Field Power
- ⑩ Internal Bus

3.1 Network interface

LAN1 and LAN2 both support switch cascading and 100Mbps connection rate.

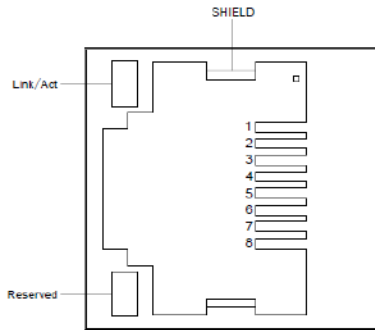

Speed: Network Speed LED (Green)

ON: 100Mbps

OFF: 10Mbps

Link/Act: Link State, Active State(Orange)

ON: Link UP

OFF: Link DOWN

Flash: Active

SHIELD: RJ45 Shield Interface

RJ45 interface pin definition

Pins	Definition	Description
1	TD+	Transmitter Signal Positive
2	TD-	Transmitter Signal Negative
3	RD+	Receiver Signal Positive
4	--	--
5	--	--
6	RD-	Receiver Signal Negative
7	--	--
8	--	--

3.2 Configuration Interface

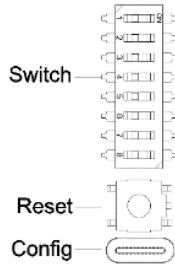

Switch: the DIP switch is used for setting the IP address (the default IP address is 192.168.1.100).

When the dial value is 0, all 4 bytes of the IP address are configured by the software or use the default IP address (192.168.1.100).

When the dial code value is not 0, the last byte of the IP address is determined by the dial code value, and the first three bytes could be configured by the software or use the default address (192.168.1).

The relationship between IP address and dial code value is shown in the following table:

Switch Bit Number (ON: 1, OFF: 0)								Switch Value	IP Address
1	2	3	4	5	6	7	8		
0	0	0	0	0	0	0	0	0	Configured by software (or default)
1	0	0	0	0	0	0	0	1	x.x.x.1
0	1	0	0	0	0	0	0	2	x.x.x.2
1	1	0	0	0	0	0	0	3	x.x.x.3
.
.
0	1	1	1	1	1	1	1	254	x.x.x.254
1	1	1	1	1	1	1	1	255	x.x.x.255

Notice: The default IP address after device reset is 192.168.1.100

Reset: Module reset button, long pressing the button for more than 5 seconds and all parameters of the module will be restored to the default value. When the Reset button is activated, a green indicator will light up in the upper left corner of the button.

Config: Configure port, a standard Type-C interface for configuring device parameters and firmware upgrades.

⚠ WARNING
OUT OF CONTROL
If the DIP Switch value is not 0, the DIP switch address value is the station address of the module.

If the PLC communicates by assigning station address, there is a conflict between the allocated address and the DIP address. After power failure and restart, the DIP value address has a high priority, resulting in abnormal communication and module loss of control.

Failure to follow instructions specified by the manufacturer may result in serious consequences such as death, personal injury, or damage to equipment since the protection provided by the equipment may be impaired.

 **AVERTISSEMENT**

PERTE DE CONTROLE

Si la valeur du commutateur DIP n'est pas 0, la valeur de l'adresse du commutateur DIP est l'adresse de la station du module. Si le PLC communique en assignant l'adresse de la station, il y a un conflit entre l'adresse allouée et l'adresse DIP. Après une panne de courant et un redémarrage, l'adresse de valeur DIP a une priorité élevée, ce qui entraîne une communication anormale et une perte de contrôle du module.

Le fait de ne pas suivre les instructions peut entraîner une défaillance de la protection fournie par l'équipement, ce qui peut entraîner des conséquences graves, comme des blessures ou des dommages à l'équipement.

3.3 LED indicator

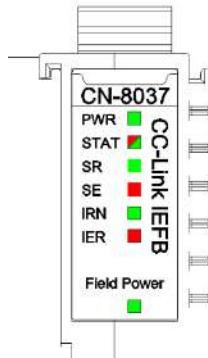

PWR Power Indicator (Green)	Definition
ON	The system power supply is normal
OFF	The system power supply is abnormal
STAT Module State Indicator (Red/Green)	Definition
Double Flash (Red)	The module exception has been soft-restarted
ON (Green)	Operational Mode
Green Single Flash	Stop mode
Flash(2.5Hz) (RedGreen)	Upgrading mode
Flash(10Hz) (Red/Green)	Firmware Upgrading
SR Station Operation Status Indicator (Green)	Definition
ON(Green)	Station operation, circular transmission is carried out
Slow Flashing (2.5Hz) (Green)	Station operation, circular transmission stops
Fast Flashing (10Hz) (Green)	The station is not configured
OFF	The station is disconnected
SE Alarm Indicator (Red)	Definition
ON (Red)	Communication errors
Flash 3 times (Red)	The DPM watchdog time out
OFF	The station is operating normally
IRN IO Operation Indicator (Green)	Definition
ON (Green)	I/O initialization is normal
OFF (Green)	IO initialization error
Flash 4 times (Green)	Lighting test
Fast Flashing (10Hz)	Invalid MAC address (all 0)
IER IO Error Indicator (Red)	Definition
OFF	I/O communication is normal
Flash 2 times (Red)	IO communication error
Fast Flashing (10Hz) (Red)	Invalid MAC address (all 0)
Field Power Indicator (Green)	Definition
ON (Green)	The field power supply is normal

OFF	The field power supply is abnormal
-----	------------------------------------

WARNING

UNEXPECTED EQUIPMENT OPERATION

By viewing the PW indicator, could determine the power supply status of a module. If the PW is steady green, the power supply is normal. Otherwise, the module cannot work properly.

When the module is initially powered on, there will be 3S for the backplane bus connection. After the backplane bus is initialized, STA is in the green steady state. If STA is in the green blinking state, it indicates that the backplane bus has not been initialized, and it needs to be powered off and restarted for re-initialization.

STA abnormal working state occurs during the normal operation of the module, please check the firmware version information of all modules, and consult ODOT technical support for details.

If a module is upgraded, check that all modules are in the normal state after the upgrade. Otherwise, an exception may occur.

Failure to follow instructions specified by the manufacturer may result in serious consequences such as death, personal injury, or damage to equipment since the protection provided by the equipment may be impaired.

AVERTISSEMENT

FONCTIONNEMENT INATTENDU DE L'EQUIPEMENT

En regardant l'état de l'indicateur de PW, jugez l'état d'alimentation du module. Le feu vert PW reste allumé et l'alimentation est normale. Autrement, le module ne fonctionnera pas correctement.

Lorsque le module est alimenté initialement, il y aura 3S pour la connexion de bus de backboard. STA est un état vert permanent après l'initialisation du bus de backboard. Si STA est en état de clignotement vert, cela signifie que l'initialisation du bus de backboard n'est pas passée et doit être redémarrée hors tension et réinitialisée.

L'état de fonctionnement anormal de STA se produit pendant le fonctionnement normal du module, veuillez vérifier les informations de version du firmware de tous les modules, et consulter le support technique ODOT pour plus de détails.

Si le module a une opération de mise à niveau, après l'achèvement de la mise à niveau, le besoin de vérifier que tous les modules sont dans l'état normal avant de courir, sinon il conduira à une exception.

Le fait de ne pas suivre les instructions peut entraîner une défaillance de la protection fournie par l'équipement, ce qui peut entraîner des conséquences graves, comme des blessures ou des dommages à l'équipement.

4 Wiring

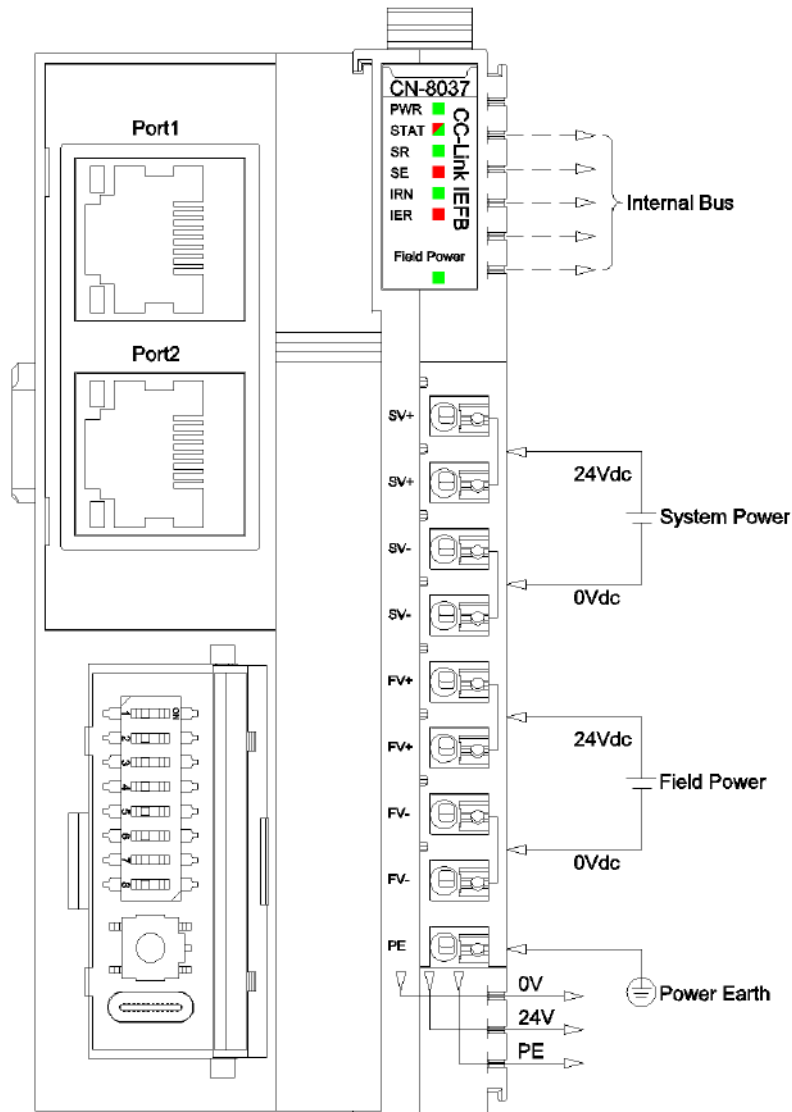

NOTICE

UNEXPECTED DEVICE OPERATION

Inside the module, two terminal blocks SV+ have been shorted, two terminal blocks SV - have been shorted, two terminal blocks FV+ have been shorted, and two terminal blocks FV - have been shorted. Externally, only one system power supply and one field power supply need to be connected.

The wire should be copper wire with a core greater than 0.2mm² and less than 1mm², and the impedance is less than 10Ω.

Failure to follow instructions specified by the manufacturer may result in serious consequences such as death, personal injury, or damage to equipment since the protection provided by the equipment may be impaired.

5 Process data definition

5.1 Module process data definition

Input data								
	Bit 7	Bit 6	Bit 5	Bit 4	Bit 3	Bit 2	Bit 1	Bit 0
Byte 0	Reserved							
Byte 1								
Byte 2	Reserved							
Byte 3								
Byte 4	Reserved							
Byte 5								
Byte 6	Reserved							
Byte 7								

Data Description:

Byte 0 ~Byte 7: retains data for the input.

Output data								
	Bit 7	Bit 6	Bit 5	Bit 4	Bit 3	Bit 2	Bit 1	Bit 0
Byte 0	Reserved							
Byte 1								
Byte 2	Reserved							
Byte 3								
Byte 4	Reserved							
Byte 5								
Byte 6	Reserved							
Byte 7								

Data Description:

Byte 0 ~Byte 7: retains data for the output.

6 Configuration parameter definition

Configuration parameters								
	Bit 7	Bit 6	Bit 5	Bit 4	Bit 3	Bit 2	Bit 1	Bit 0
Byte 0	Reserved					Fault Action for Output	Fault Action for Input	Source of Config Data

Communication parameters	
Byte 1	Mac Address
Byte 2	
Byte 3	
Byte 4	
Byte 5	
Byte 6	
Byte 7	IP Address
Byte 8	
Byte 9	
Byte 10	
Byte 11	Net Mask
Byte 12	
Byte 13	
Byte 14	
Byte 15	Net Gateway
Byte 16	
Byte 17	
Byte 18	
Byte 19	Occupied Stations
Byte 20	Auto Stations Enable
Byte 21	RX/RX Size (Bits)
Byte 22	
Byte 23	RW _r /RW _w Size(words)
Byte 24	
Byte 25 ... Byte 32	Reserved

Data Description:

Config Source: the parameter configuration method. (Default: 0)

0: Configured by the software configuration

Fault Action for Input: Input fault handling mode. When the I/O module is offline, the adapter processes the input data of the I/O module in this mode. (Default: 0)

0: Hold last input value

1: Clear input value

Fault Action for Output: Output fault handling mode. When the CC-Link IE Field Network Basic communication fails, the adapter processes the output data of the I/O module in this mode. (Default: 0)

0: Hold last output value

1: Clear output value

MAC Address: read-only of the MAC address.

IP Address: The IP address of the adapter, when the value of the DIP switch is not 0, the last byte of the IP address is replaced by the DIP value.

Net Mask: the subnet mask.

Net Gateway: the gateway address.

Auto Stations Enable: Whether automatically calculates the number of stations (based on the number of I/O modules that are actually configured). (Default: 0)

0: Disable

1: Enable

RX/RX Size(Bits): RX/RX capacity (bits).

RWr/RWw Size(words): RWr/RWw capacity (words).

A Dimensional drawing

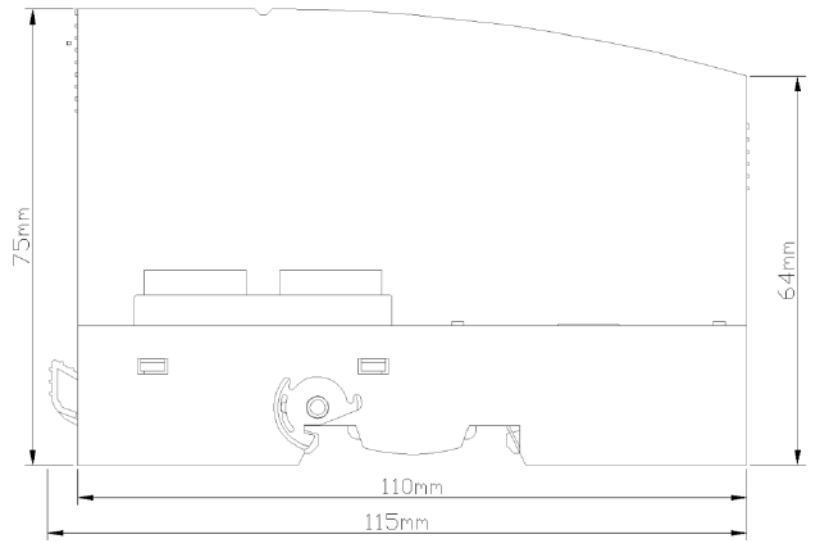
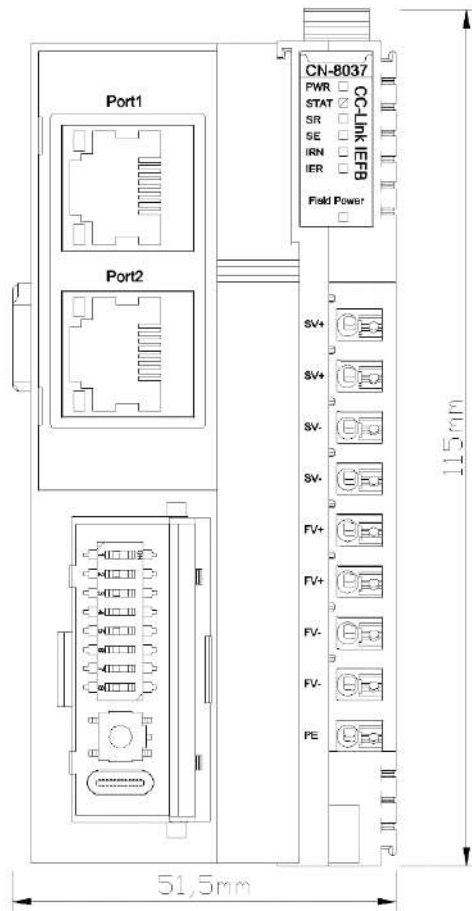

3 Extended IO module

CT-1218 8 channels digital input/24VDC/PNP

1 Module features

- ◆ The module supports 8 channels digital input, supports sink input, and the input voltage is 24VDC and the input high level is valid. It could support PNP sensor.
- ◆ The module could collect digital output signal of field equipment (dry contact or active output).
- ◆ The module could be accessed to 2-wire or 3-wire digital sensor.
- ◆ The internal bus and field input of the module use opto-isolator.
- ◆ The module supports the input signal holding function, and the holding time can be set.
- ◆ The module carries 8 digital input channels with LED indicator on each channel.
- ◆ Supports counting function after adding counting sub-module.
- ◆ Each input channel of the module supports a 32-bit counter with the counting frequency <math><200\text{Hz}</math>.
- ◆ The module could be set the digital signal input filtering time and the byte transmission order of the counter.
- ◆ Each channel of the module could be set the counting mode and counting direction independently.

2 Technical parameters

General Parameters	
Power Consumption	Max.52mA@5.0VDC
Isolation	I/O to internal bus: opto-couple isolation (3KVrms)
Field Power	Nominal:24VDC, Range:20.4-28.8VDC
Wiring	Max.: AWG 18 Min.: AWG 24
Installation	35mm DIN-Rail
Size	115*14*75mm
Weight	65g
Environment Specification	
Operating Temperature of Horizontal Installation	-35°C~70°C
Operating Temperature of Vertical Installation	-35°C~60°C
Relative Humidity	< 95%RH (No Condensation)
Storage Temperature	-40°C~85°C
Storage Humidity	< 95%RH (No Condensation)
Manufacturing Test Temperature	-40°C~75°C
Ingress Protection Rating	IP20
Input Parameters	
Channel Number	8 channel sink input
LED Indicator	8 channel input LED indicator
Turn-on voltage	Min.10VDC to Max.28VDC
Turn-off Voltage	Max.5VDC
Turn-on current	Max. 5mA/channel@28V
Input impedance	>7.5kΩ
Input delay	OFF to ON: Max.3ms ON to OFF: Max.2ms
Filter time	Default 10ms
Sample frequency	500Hz
Counter frequency	<200Hz
Effective pulse width for counting	2.5ms

 **WARNING**

UNEXPECTED EQUIPMENT OPERATION

Do not exceed any of the ratings specified in the environmental and electrical characteristics table.

Failure to follow instructions specified by the manufacturer may result in serious consequences such as death, personal injury, or damage to equipment since the protection provided by the equipment may be impaired.

 **AVERTISSEMENT**

FONCTIONNEMENT INATTENDU DE L'EQUIPEMENT

Ne dépassez aucune évaluation spécifiée dans le tableau de caractéristiques environnementales et électriques..

Le fait de ne pas suivre les instructions peut entraîner une défaillance de la protection fournie par l'équipement, ce qui peut entraîner des conséquences graves, comme des blessures ou des dommages à l'équipement.

3 Hardware interfaces

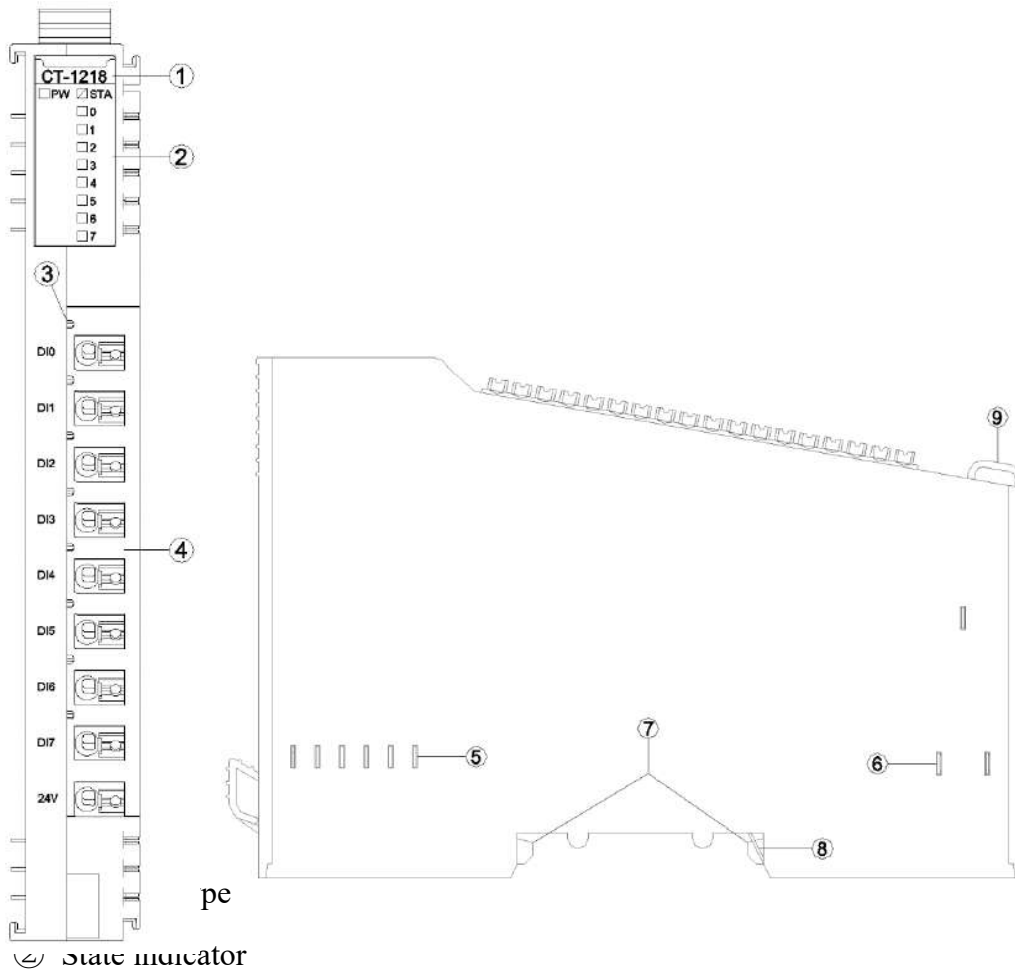

① State indicator

③ Channel indicator

④ Wiring Terminal and identification

⑤ Internal Bus

⑥ Field Power

⑦ Buckle

⑧ Grounding Spring Sheet

⑨ Fixed Wiring Harness

3.1 LED indicator definition

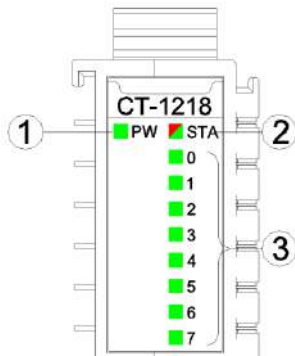

- ① Power LED indicator (green)
- ② Module State LED indicator (red/green)
- ③ Input channel LED indicator (green)

PW Power State (GREEN)	Definition
ON	Internal bus Power Normal
OFF	Internal bus Power Failure
STA Module State (RED/GREEN)	Definition
Green slow flash (2.5Hz)	Module internal bus is not started
Red slow flash (2.5Hz)	Module internal bus offline
ON (GREEN)	Operation normal
Flash(2.5Hz) (RED/GREEN)	Upgrading mode
Flash(10Hz) (RED/GREEN)	Firmware Update
Double Flash (RED)	Module Exception has been soft-restarted
0-7 channel LED indicator	Definition
ON	Input signal valid
OFF	Input signal invalid

WARNING

UNEXPECTED EQUIPMENT OPERATION

By viewing the PW indicator, could determine the power supply status of a module. If the PW is steady green, the power supply is normal. Otherwise, the module cannot work properly.

When the module is initially powered on, there will be 3S for the backplane bus connection. After the backplane bus is initialized, STA is in the green steady state. If STA is in the green blinking state, it indicates that the backplane bus has not been initialized, and it needs to be powered off and restarted for re-initialization.

STA abnormal working state occurs during the normal operation of the module, please check the firmware version information of all modules, and consult ODOT technical support for details.

If a module is upgraded, check that all modules are in the normal state after the upgrade. Otherwise, an exception may occur.

Failure to follow instructions specified by the manufacturer may result in serious consequences such as death, personal injury, or damage to equipment since the protection provided by the equipment may be impaired.

AVERTISSEMENT

FONCTIONNEMENT INATTENDU DE L'EQUIPEMENT

En regardant l'état de l'indicateur de PW, jugez l'état d'alimentation du module. Le feu vert PW reste allumé et l'alimentation est normale. Autrement, le module ne fonctionnera pas correctement.

Lorsque le module est alimenté initialement, il y aura 3S pour la connexion de bus de backboard. STA est un état vert permanent après l'initialisation du bus de backboard. Si STA est en état de clignotement vert, cela signifie que l'initialisation du bus de backboard n'est pas passée et doit être redémarrée hors tension et réinitialisée.

L'état de fonctionnement anormal de STA se produit pendant le fonctionnement normal du module, veuillez vérifier les informations de version du firmware de tous les modules, et consulter le support technique ODOT pour plus de détails.

Si le module a une opération de mise à niveau, après l'achèvement de la mise à niveau, le besoin de vérifier que tous les modules sont dans l'état normal avant de courir, sinon il conduira à une exception.

Le fait de ne pas suivre les instructions peut entraîner une défaillance de la protection fournie par l'équipement, ce qui peut entraîner des conséquences graves, comme des blessures ou des dommages à l'équipement.

3.2 Field channel LED indicator (Green)

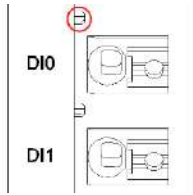

When input signal of input channel is valid, the corresponding field channel LED indicator is on.

3.3 Terminal definition

Terminal Number	Symbol	Description
1	DI0	Signal input
2	DI1	
3	DI2	
4	DI3	
5	DI4	
6	DI5	
7	DI6	
8	DI7	
9	24V	Power output

WARNING

UNEXPECTED EQUIPMENT OPERATION

The DI channel terminal provides reverse protection.

The FV power supply of the network adapter is normal. The 24V terminal on the DI module can be used for testing. Do not use the FV power supply to supply power to peripherals.

Failure to follow instructions specified by the manufacturer may result in serious consequences such as death, personal injury, or damage to equipment since the protection provided by the equipment may be impaired.

AVERTISSEMENT

FONCTIONNEMENT INATTENDU DE L'EQUIPEMENT

Le terminal de canal d'entrée numérique offre une protection inverse.

L'alimentation FV de l'adaptateur réseau est normale. Le terminal 24V du module DI peut être utilisé pour les tests. Ne pas utiliser l'alimentation FV pour alimenter les périphériques.

Le fait de ne pas suivre les instructions peut entraîner une défaillance de la protection fournie par l'équipement, ce qui peut entraîner des conséquences graves, comme des blessures ou des dommages à l'équipement.

When connecting a cold-pressed terminal, the terminal must be terminated and checked in strict accordance with the corresponding termination specifications or requirements, and connect the cold-pressed terminal according to the corresponding node serial number.

The conductor should use copper conductor and the conductor core should be larger than 0.2mm² and smaller than 1mm² (AWG18~AWG24). Cold-pressed terminal parameters are as follows:



⚠ WARNING

UNEXPECTED EQUIPMENT OPERATION

Strip the length of the conductor insulation layer is greater than 10mm to ensure reliable signal connection.

The wire needs to use copper wire and the wire core is greater than or equal to 0.2mm² and less than or equal to 1mm² to ensure reliable signal connection.

When connecting a cold-press terminal, connect the cold-press terminal strictly in accordance with the corresponding termination specifications or requirements, and connect the cold-press terminal according to the corresponding node serial number.

Do not power on cold-press terminals until they are properly connected or fully locked.

Failure to follow instructions specified by the manufacturer may result in serious consequences such as death, personal injury, or damage to equipment since the protection provided by the equipment may be impaired.

⚠ AVERTISSEMENT

FONCTIONNEMENT INATTENDU DE L'EQUIPEMENT

Dépouillez la longueur de la couche isolante du fil plus de 10mm pour assurer la connexion fiable du signal.

Le conducteur doit utiliser le fil de cuivre et le noyau de fil est supérieur ou égal à 0,2 mm², inférieur ou égal à 1mm², afin d'assurer la connexion fiable du signal.

Lorsque les terminaux de presse à froid sont terminés, ils doivent être terminés et visualisés en stricte conformité avec les spécifications ou les exigences correspondantes et terminés selon le numéro de série de noeud correspondant.

Il est interdit d'activer les bornes à froid avant qu'elles ne soient correctement articulées ou complètement verrouillées.

Le fait de ne pas suivre les instructions peut entraîner une défaillance de la protection fournie par l'équipement, ce qui peut entraîner des conséquences graves, comme des blessures ou des dommages à l'équipement.

DANGER

FIRE DANGER

Use the correct wiring rules only for the maximum current capacity of the I/O channel and power supply.

Failure to follow instructions specified by the manufacturer may result in serious consequences such as death, personal injury, or damage to equipment since the protection provided by the equipment may be impaired.

WARNING

UNEXPECTED EQUIPMENT OPERATION

Do not exceed any of the ratings specified in the environmental and electrical characteristics table.

Failure to follow instructions specified by the manufacturer may result in serious consequences such as death, personal injury, or damage to equipment since the protection provided by the equipment may be impaired.

AVERTISSEMENT

FONCTIONNEMENT INATTENDU DE L'EQUIPEMENT

Ne dépassez aucune évaluation spécifiée dans le tableau de caractéristiques environnementales et électriques..

Le fait de ne pas suivre les instructions peut entraîner une défaillance de la protection fournie par l'équipement, ce qui peut entraîner des conséquences graves, comme des blessures ou des dommages à l'équipement.

4 Wiring

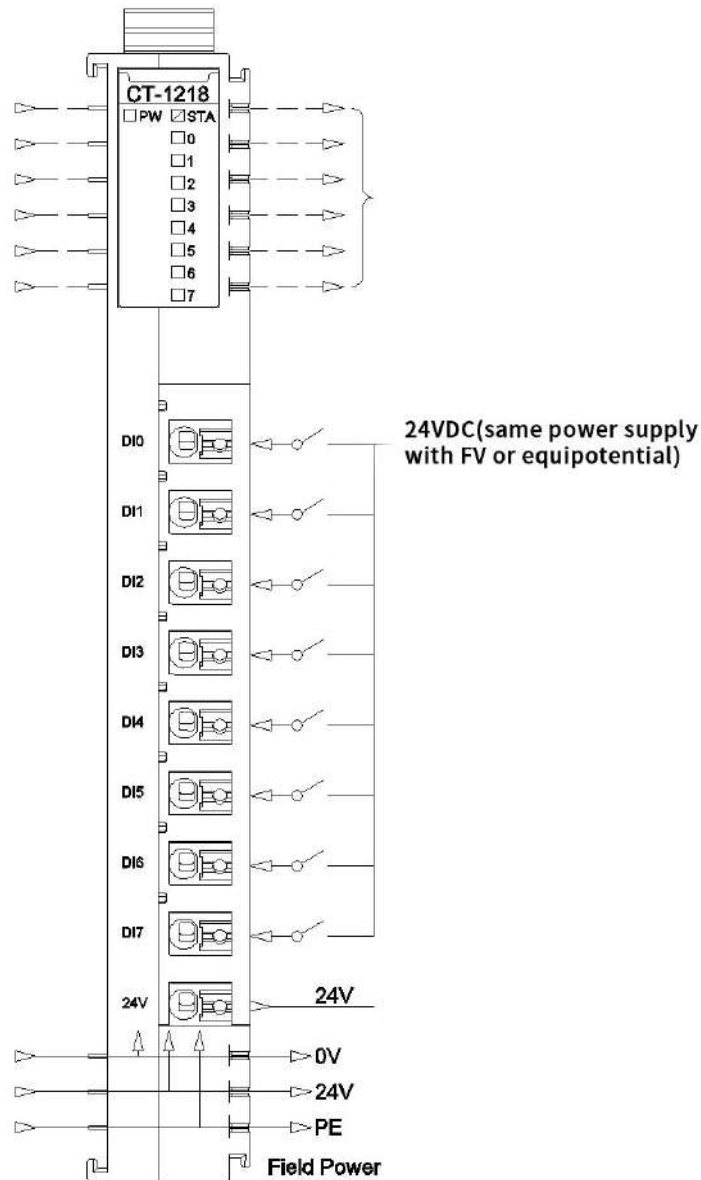

NOTICE

EQUIPMENT INOPERABLE

Do not crimp the spring terminal with more than the maximum pressure specified for the terminal. Otherwise, the resilience of the spring terminal may be damaged and the terminal rebound may be affected.

Do not press the spring terminal with a sharp tool when removing cable from the channel. Otherwise, the spring terminal will be damaged.

Failure to follow these instructions may result in equipment damage.

5 Process data definition

<8DI Input Status> Submodule process data definition

Input data								
Bit No	Bit 7	Bit 6	Bit 5	Bit 4	Bit 3	Bit 2	Bit 1	Bit 0
Byte 0	DI Ch#7	DI Ch#6	DI Ch#5	DI Ch#4	DI Ch#3	DI Ch#2	DI Ch#1	DI Ch#0

Data description:

DI Ch#(0-7): When the corresponding channel input signal is valid, the bit is 1, and when the input is invalid, it is 0.

0: Input signal invalid

1: Input signal valid

<8DI Counter Submodule> Submodule process data definition:

Input data								
Bit No	Bit 7	Bit 6	Bit 5	Bit 4	Bit 3	Bit 2	Bit 1	Bit 0
Byte 0	Counter Value Ch#0							
Byte 1								
Byte 2								
Byte 3								
Byte 4	Counter Value Ch#1							
Byte 5								
Byte 6								
Byte 7								
Byte 8	Counter Value Ch#2							
Byte 9								
Byte 10								
Byte 11								
Byte 12	Counter Value Ch#3							
Byte 13								
Byte 14								
Byte 15								
Byte 16	Counter Value Ch#4							
Byte 17								
Byte 18								
Byte 19								
Byte 20	Counter Value Ch#5							
Byte 21								
Byte 22								
Byte 23								
Byte 24	Counter Value Ch#6							
Byte 25								
Byte 26								

Byte 27								
Byte 28								
Byte 29	Counter Value Ch#7							
Byte 30								
Byte 31								
Byte 31								
Output data								
Bit No	Bit 7	Bit 6	Bit 5	Bit 4	Bit 3	Bit 2	Bit 1	Bit 0
Byte 0	Counter Reset Ch#7	Counter Reset Ch#6	Counter Reset Ch#5	Counter Reset Ch#4	Counter Reset Ch#3	Counter Reset Ch#2	Counter Reset Ch#1	Counter Reset Ch#0

Data description:

Counter Value Ch#(0-7): Count value, 32-bit unsigned integer, automatically zeroing after overflow.

Counter Reset Ch#(0-7): When the data bit changes from 0 to 1 (rising edge), the input counter of the corresponding channel is cleared.

Note: the maximum counting frequency of the input channel is 200Hz. When the input signal exceeds this frequency, the counting result may be inconsistent with the actual value.

6 Configuration parameter definitions

<8DI Input Status> Submodule configuration parameter definition

Configuration parameters								
Bit No	Bit 7	Bit 6	Bit 5	Bit 4	Bit 3	Bit 2	Bit 1	Bit 0
Byte 0	Input Filtering Time(ms)							
Byte 1								
Byte 2	Reserved					Input Holding Time(ms)		

Data description:

Input Filtering Time(ms): Input filter time of Channel (ms) (Default: 10)

Input Holding Time(ms): Signal input holding time of Channel (ms) (Default:0)

- 0: Disable
- 1: 200ms
- 2: 500ms
- 3: 1000ms
- 4: 1500ms
- 5: 2000ms
- 6: 3000ms
- 7: 5000ms

<8DI Counter Submodule> Submodule configuration parameter definition

Configuration parameters								
Bit No	Bit 7	Bit 6	Bit 5	Bit 4	Bit 3	Bit 2	Bit 1	Bit 0
Byte 0	Reserved				Storage Enable	Storage Function	32Bit Data Format	
Byte 1	Count Mode Ch#3		Count Mode Ch#2		Count Mode Ch#1		Count Mode Ch#0	
Byte 2	Count Mode Ch#7		Count Mode Ch#6		Count Mode Ch#5		Count Mode Ch#4	
Byte 3	Count Direction Ch#7	Count Direction Ch#6	Count Direction Ch#5	Count Direction Ch#4	Count Direction Ch#3	Count Direction Ch#2	Count Direction Ch#1	Count Direction Ch#0

Data description:

32Bit Data Format: Byte transfer order of Channel count value (Default: 0)

- 0: AB-CD

1: BA-DC

2: CD-AB

3: DC-BA

Storage Function: Storage Function is supported or not, read only, and this value is the actual value of the module when uploading device parameters.

0: storage is not supported

1: storage is supported

Storage Enable: Storage enable, when the Storage Function enables, the IO module will save the count value in real time to non-volatile memory, and load the last saved count value on the next power on. (Default: 1)

0: Disabled

1: Enable

Count Mode Ch# (0-7): Count mode of the input channel. (Default: 0)

0: rising edge count

1: falling edge count

2: double edge count

Count Direction Ch# (0-7): The counting direction of the input channel. (Default: 0)

0: count up

1: count down

A Dimension drawing

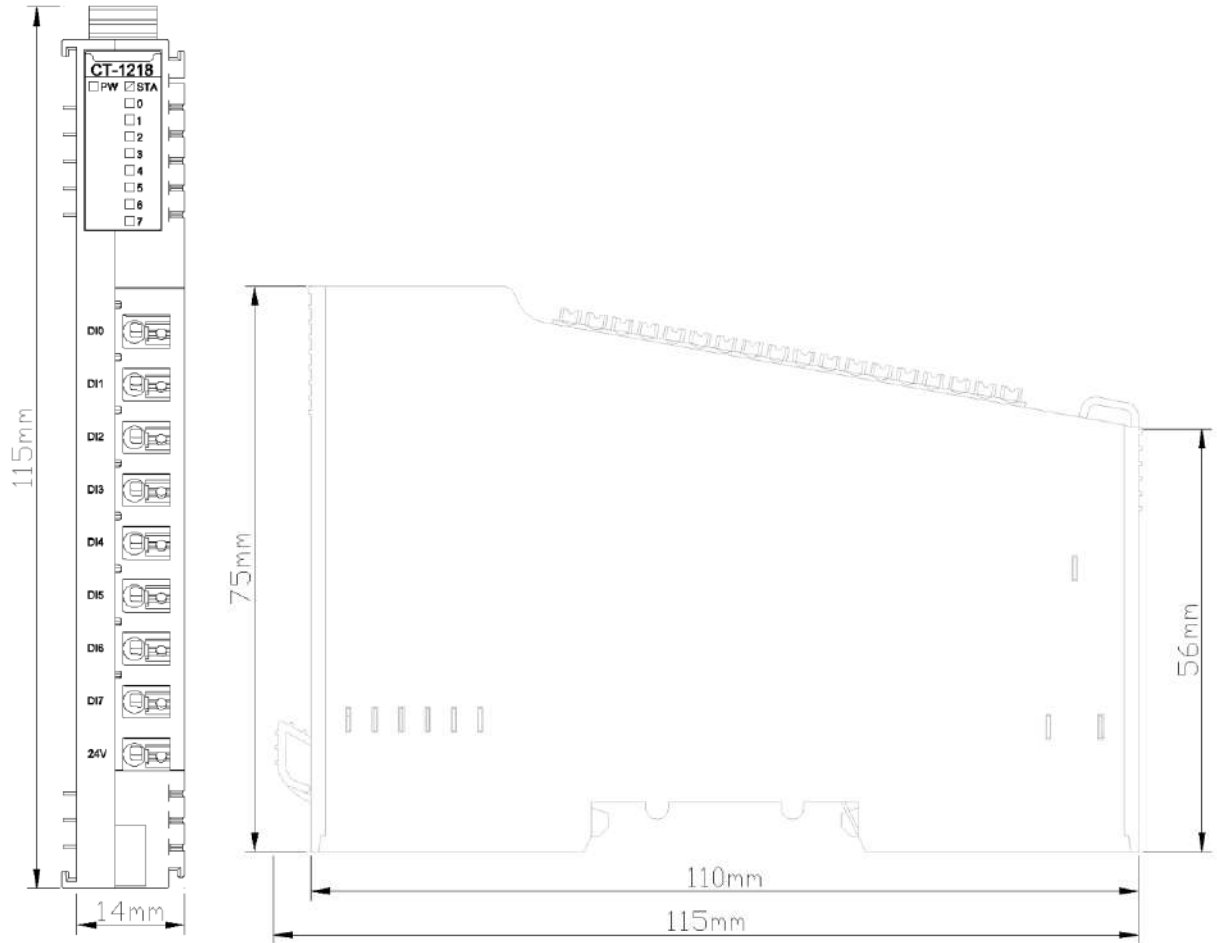

CT-121F 16 channels digital input/24VDC/ PNP

1 Module features

- ◆ The module supports 16 channels digital input, supports sink input, and the input voltage is 24VDC and the input high level is valid. It could support PNP sensor.
- ◆ The module could collect digital output signal of field equipment (dry contact or active output).
- ◆ The module could be accessed to 2-wire or 3-wire digital sensor.
- ◆ The internal bus and field input of the module use opto-isolator.
- ◆ The module supports the input signal holding function, and the holding time can be set.
- ◆ The module carries 16 digital input channels with LED indicator on each channel.
- ◆ Supports counting function after adding counting sub-module.
- ◆ Each input channel of the module supports a 32-bit counter with the counting frequency <200Hz.
- ◆ The module could be set the digital signal input filtering time and the byte transmission order of the counter.
- ◆ Each channel of the module could be set the counting mode and counting direction independently.

2 Technical parameters

General Parameters	
Power Consumption	Max.60mA@5.0VDC
Isolation	I/O to internal bus: opto-couple isolation (3KVRms)
Field Power	Nominal:24VDC, Range:20.4-28.8VDC
Wiring	Max.: AWG 18 Min.: AWG 24
Installation	35mm DIN-Rail
Size	115*14*75mm
Weight	65g
Vibration Resistance	Comply with IEC 61131-2 and EC 60068-2-6
Impact resistance	Comply with IEC 61131-2 and IEC 60068-2-27
EMC Performance	Comply with IEC 61131-2 and IEC 61000-4
Environment Specification	
Operating Temperature of Horizontal Installation	-35°C~70°C
Operating Temperature of Vertical Installation	-35°C~60°C
Relative Humidity	< 95%RH (No Condensation)
Storage Temperature	-40°C~85°C
Storage Humidity	< 95%RH (No Condensation)
Manufacturing Test Temperature	-40°C~75°C
Ingress Protection Rating	IP20
Input Parameters	
Channel Number	16 channel sink input
LED Indicator	16 channel input LED indicator
Turn-on Voltage	Min.10VDC to Max.28VDC
Turn-off Voltage	Max.5VDC
Turn-on Current	Max.5mA/channel@28V
Input impedance	>7.5kΩ
Input Delay	OFF to ON: Max.3ms ON to OFF: Max.2ms
Filter Time	Default 10ms
Sample Frequency	500Hz
Counter Frequency	<200Hz
Effective pulse width for counting	2.5ms

 **WARNING**

UNEXPECTED EQUIPMENT OPERATION

Do not exceed any of the ratings specified in the environmental and electrical characteristics table.

Failure to follow instructions specified by the manufacturer may result in serious consequences such as death, personal injury, or damage to equipment since the protection provided by the equipment may be impaired.

 **AVERTISSEMENT**

FONCTIONNEMENT INATTENDU DE L'EQUIPEMENT

Ne dépassez aucune évaluation spécifiée dans le tableau de caractéristiques environnementales et électriques..

Le fait de ne pas suivre les instructions peut entraîner une défaillance de la protection fournie par l'équipement, ce qui peut entraîner des conséquences graves, comme des blessures ou des dommages à l'équipement.

3 Hardware interfaces

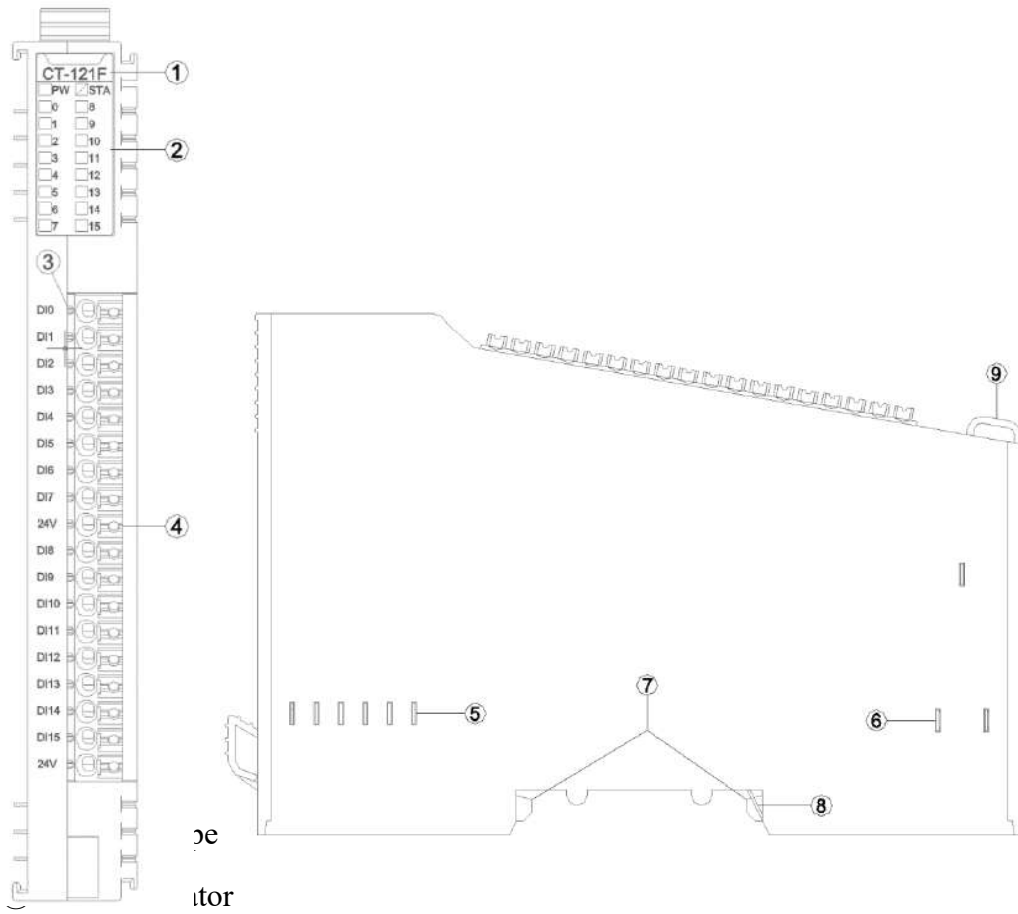

- ③ Channel indicator
- ④ Wiring Terminal and identification
- ⑤ Internal Bus
- ⑥ Field Power
- ⑦ Buckle
- ⑧ Grounding Spring Sheet
- ⑨ Fixed Wiring Harness

3.1 LED indicator definition

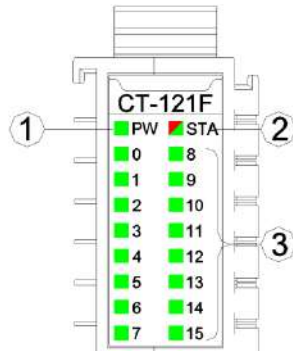

- ① Power LED indicator (green)
- ② Module State LED indicator (red/green)
- ③ Input channel LED indicator (green)

PW Power State (GREEN)	Definition
ON	Internal bus Power Normal
OFF	Internal bus Power Failure
STA Module State (RED/GREEN)	Definition
Green slow flash (2.5Hz)	Module internal bus is not started
Red slow flash (2.5Hz)	Module internal bus offline
ON (GREEN)	Operation normal
Flash(2.5Hz) (RED/GREEN)	Upgrading mode
Flash(10Hz) (RED/GREEN)	Firmware Update
Double Flash (RED)	Module Exception has been soft-restarted
0-15 channel indicator light	Definition
ON	Input signal valid
OFF	Input signal invalid

! WARNING

UNEXPECTED EQUIPMENT OPERATION

By viewing the PW indicator, could determine the power supply status of a module. If the PW is steady green, the power supply is normal. Otherwise, the module cannot work properly.

When the module is initially powered on, there will be 3S for the backplane bus connection. After the backplane bus is initialized, STA is in the green steady state. If STA is in the green blinking state, it indicates that the backplane bus has not been initialized, and it needs to be powered off and restarted for re-initialization.

STA abnormal working state occurs during the normal operation of the module, please check the firmware version information of all modules, and consult ODOT technical support for details.

If a module is upgraded, check that all modules are in the normal state after the upgrade. Otherwise, an exception may occur.

Failure to follow instructions specified by the manufacturer may result in serious

consequences such as death, personal injury, or damage to equipment since the protection provided by the equipment may be impaired.

⚠️ AVERTISSEMENT

FONCTIONNEMENT INATTENDU DE L'EQUIPEMENT

En regardant l'état de l'indicateur de PW, jugez l'état d'alimentation du module. Le feu vert PW reste allumé et l'alimentation est normale. Autrement, le module ne fonctionnera pas correctement.

Lorsque le module est alimenté initialement, il y aura 3S pour la connexion de bus de backboard. STA est un état vert permanent après l'initialisation du bus de backboard. Si STA est en état de clignotement vert, cela signifie que l'initialisation du bus de backboard n'est pas passée et doit être redémarrée hors tension et réinitialisée.

L'état de fonctionnement anormal de STA se produit pendant le fonctionnement normal du module, veuillez vérifier les informations de version du firmware de tous les modules, et consulter le support technique ODOT pour plus de détails.

Si le module a une opération de mise à niveau, après l'achèvement de la mise à niveau, le besoin de vérifier que tous les modules sont dans l'état normal avant de courir, sinon il conduira à une exception.

Le fait de ne pas suivre les instructions peut entraîner une défaillance de la protection fournie par l'équipement, ce qui peut entraîner des conséquences graves, comme des blessures ou des dommages à l'équipement.

3.2 Field channel LED indicator (Green)

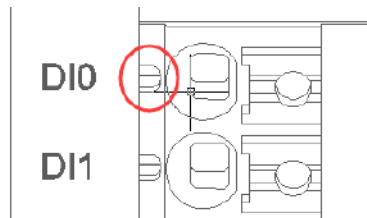

When input signal of input channel is valid, the corresponding field channel LED indicator is on.

3.3 Terminal definition

Terminal Number	Symbol	Description
1	DI0	Signal input
2	DI1	
3	DI2	
4	DI3	
5	DI4	
6	DI5	
7	DI6	
8	DI7	
9	24V	Power output
10	DI8	Signal input
11	DI9	
12	DI10	
13	DI11	
14	DI12	
15	DI13	
16	DI14	
17	DI15	
18	24V	Power output

WARNING

UNEXPECTED EQUIPMENT OPERATION

The DI channel terminal provides reverse protection.

The FV power supply of the network adapter is normal. The 24V terminal on the DI module can be used for testing. Do not use the FV power supply to supply power to peripherals.

Failure to follow instructions specified by the manufacturer may result in serious consequences such as death, personal injury, or damage to equipment since the protection provided by the equipment may be impaired.

AVERTISSEMENT

FONCTIONNEMENT INATTENDU DE L'EQUIPEMENT

Le terminal de canal d'entrée numérique offre une protection inverse.

L'alimentation FV de l'adaptateur réseau est normale. Le terminal 24V du module DI peut être utilisé pour les tests. Ne pas utiliser l'alimentation FV pour alimenter les périphériques.

Le fait de ne pas suivre les instructions peut entraîner une défaillance de la protection fournie par l'équipement, ce qui peut entraîner des conséquences graves, comme des blessures ou des dommages à l'équipement.

When connecting a cold-pressed terminal, the terminal must be terminated and checked in strict accordance with the corresponding termination specifications or requirements,

and connect the cold-pressed terminal according to the corresponding node serial number. The conductor should use copper conductor and the conductor core should be larger than 0.2mm^2 and smaller than 1mm^2 (AWG18~AWG24). Cold-pressed terminal parameters are as follows:

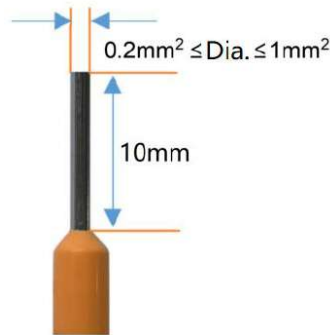

⚠ WARNING

UNEXPECTED EQUIPMENT OPERATION

Strip the length of the conductor insulation layer is greater than 10mm to ensure reliable signal connection.

The wire needs to use copper wire and the wire core is greater than or equal to 0.2mm^2 and less than or equal to 1mm^2 to ensure reliable signal connection.

When connecting a cold-press terminal, connect the cold-press terminal strictly in accordance with the corresponding termination specifications or requirements, and connect the cold-press terminal according to the corresponding node serial number.

Do not power on cold-press terminals until they are properly connected or fully locked.

Failure to follow instructions specified by the manufacturer may result in serious consequences such as death, personal injury, or damage to equipment since the protection provided by the equipment may be impaired.

⚠ AVERTISSEMENT

FONCTIONNEMENT INATTENDU DE L'EQUIPEMENT

Dépouillez la longueur de la couche isolante du fil plus de 10mm pour assurer la connexion fiable du signal.

Le conducteur doit utiliser le fil de cuivre et le noyau de fil est supérieur ou égal à $0,2\text{ mm}^2$, inférieur ou égal à 1mm^2 , afin d'assurer la connexion fiable du signal.

Lorsque les terminaux de presse à froid sont terminés, ils doivent être terminés et visualisés en stricte conformité avec les spécifications ou les exigences correspondantes et terminés selon le numéro de série de noeud correspondant.

Il est interdit d'activer les bornes à froid avant qu'elles ne soient correctement articulées ou complètement verrouillées.

Le fait de ne pas suivre les instructions peut entraîner une défaillance de la protection fournie par l'équipement, ce qui peut entraîner des conséquences graves, comme des blessures ou des dommages à l'équipement.

DANGER

FIRE DANGER

Use the correct wiring rules only for the maximum current capacity of the I/O channel and power supply.

Failure to follow instructions specified by the manufacturer may result in serious consequences such as death, personal injury, or damage to equipment since the protection provided by the equipment may be impaired.

WARNING

UNEXPECTED EQUIPMENT OPERATION

Do not exceed any of the ratings specified in the environmental and electrical characteristics table.

Failure to follow instructions specified by the manufacturer may result in serious consequences such as death, personal injury, or damage to equipment since the protection provided by the equipment may be impaired.

AVERTISSEMENT

FONCTIONNEMENT INATTENDU DE L'EQUIPEMENT

Ne dépassez aucune évaluation spécifiée dans le tableau de caractéristiques environnementales et électriques..

Le fait de ne pas suivre les instructions peut entraîner une défaillance de la protection fournie par l'équipement, ce qui peut entraîner des conséquences graves, comme des blessures ou des dommages à l'équipement.

4 Wiring

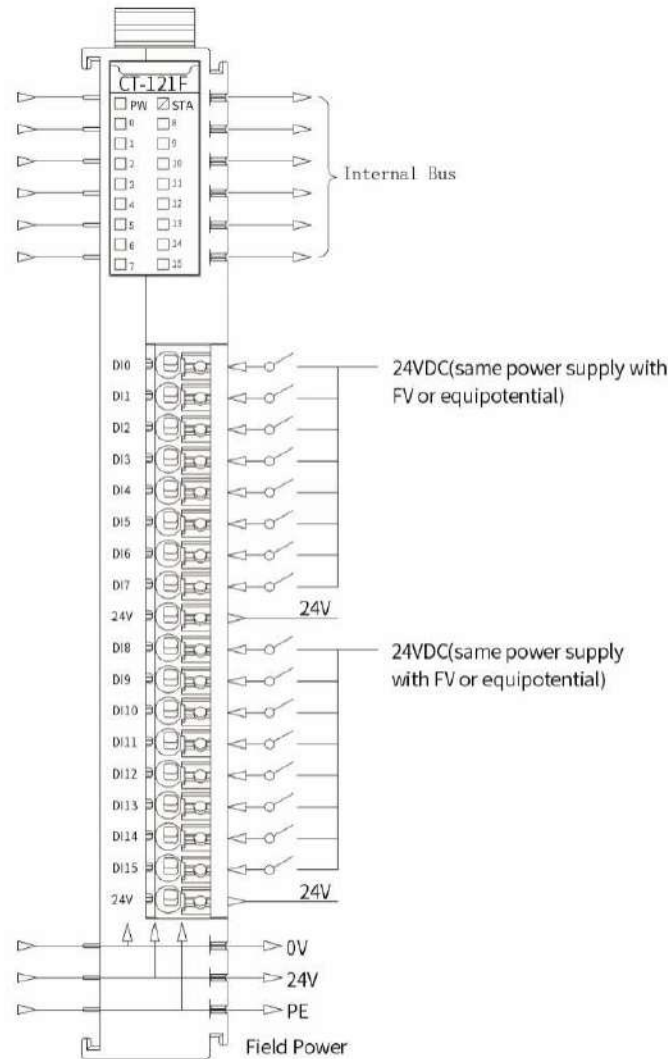

NOTICE

EQUIPMENT INOPERABLE

Do not crimp the spring terminal with more than the maximum pressure specified for the terminal. Otherwise, the resilience of the spring terminal may be damaged and the terminal rebound may be affected.

Do not press the spring terminal with a sharp tool when removing cable from the channel. Otherwise, the spring terminal will be damaged.

Failure to follow these instructions may result in equipment damage.

5 Process data definition

<16DI Input State> Submodule process data definition

Input data								
Bit No	Bit 7	Bit 6	Bit 5	Bit 4	Bit 3	Bit 2	Bit 1	Bit 0
Byte 0	DI Ch#7	DI Ch#6	DI Ch#5	DI Ch#4	DI Ch#3	DI Ch#2	DI Ch#1	DI Ch#0
Byte 1	DI Ch#15	DI Ch#14	DI Ch#13	DI Ch#12	DI Ch#11	DI Ch#10	DI Ch#9	DI Ch#8

Data description:

DI Ch#(0-15): When the corresponding channel input signal is valid, the bit is 1, and when the input is invalid, it is 0.

0: Input signal invalid

1: Input signal valid

<16DI Counter Submodule> Submodule process data definition:

Input data								
Bit No	Bit 7	Bit 6	Bit 5	Bit 4	Bit 3	Bit 2	Bit 1	Bit 0
Byte 0	Counter Value Ch#0							
Byte 1								
Byte 2								
Byte 3								
Byte 4	Counter Value Ch#1							
Byte 5								
Byte 6								
Byte 7								
Byte 8	Counter Value Ch#2							
Byte 9								
Byte 10								
Byte 11								
Byte 12	Counter Value Ch#3							
Byte 13								
Byte 14								
Byte 15								
Byte 16	Counter Value Ch#4							
Byte 17								
Byte 18								
Byte 19								
Byte 20	Counter Value Ch#5							
Byte 21								
Byte 22								

Byte 23								
Byte 24								
Byte 25	Counter Value Ch#6							
Byte 26								
Byte 27								
Byte 28								
Byte 29	Counter Value Ch#7							
Byte 30								
Byte 31								
Byte 32								
Byte 33	Counter Value Ch#8							
Byte 34								
Byte 35								
Byte 36								
Byte 37	Counter Value Ch#9							
Byte 38								
Byte 39								
Byte 40								
Byte 41	Counter Value Ch#10							
Byte 42								
Byte 43								
Byte 44								
Byte 45	Counter Value Ch#11							
Byte 46								
Byte 47								
Byte 48								
Byte 49	Counter Value Ch#12							
Byte 50								
Byte 51								
Byte 52								
Byte 53	Counter Value Ch#13							
Byte 54								
Byte 55								
Byte 56								
Byte 57	Counter Value Ch#14							
Byte 58								
Byte 59								
Byte 60								
Byte 61	Counter Value Ch#15							
Byte 62								
Byte 63								
Byte 63								
Output data								
Bit No	Bit 7	Bit 6	Bit 5	Bit 4	Bit 3	Bit 2	Bit 1	Bit 0
Byte 0	Counter Reset Ch#7	Counter Reset Ch#6	Counter Reset Ch#5	Counter Reset Ch#4	Counter Reset Ch#3	Counter Reset Ch#2	Counter Reset Ch#1	Counter Reset Ch#0

Byte 1	Counter Reset Ch#15	Counter Reset Ch#14	Counter Reset Ch#13	Counter Reset Ch#12	Counter Reset Ch#11	Counter Reset Ch#10	Counter Reset Ch#9	Counter Reset Ch#8
--------	---------------------------	---------------------------	---------------------------	---------------------------	---------------------------	---------------------------	--------------------------	--------------------------

Data description:

Counter Value Ch#(0-15): Count value, 32-bit unsigned integer, automatically zeroing after overflow.

Counter Reset Ch#(0-15): When the data bit changes from 0 to 1 (rising edge), the input counter of the corresponding channel is cleared.

Note: the maximum counting frequency of the input channel is 200Hz. When the input signal exceeds this frequency, the counting result may be inconsistent with the actual value.

6 Configuration parameter definitions

<16DI Input State> Submodule configuration parameter definition

Configuration parameters								
Bit No	Bit 7	Bit 6	Bit 5	Bit 4	Bit 3	Bit 2	Bit 1	Bit 0
Byte 0	Input Filtering Time(ms)							
Byte 1								
Byte 2	Reserved					Input Holding Time(ms)		

Data description:

Input Filtering Time(ms): Input filter time of Channel (ms) (Default: 10)

Input Holding Time(ms): Signal input holding time of Channel (ms) (Default:0)

- 0: Disable
- 1: 200ms
- 2: 500ms
- 3: 1000ms
- 4: 1500ms
- 5: 2000ms
- 6: 3000ms
- 7: 5000ms

<16DI Counter Submodule> Submodule configuration parameter definition

Configuration parameters								
Bit No	Bit 7	Bit 6	Bit 5	Bit 4	Bit 3	Bit 2	Bit 1	Bit 0
Byte 0	Reserved				Storage Enable	Storage Function	32Bit Data Format	
Byte 1	Count Mode Ch#3		Count Mode Ch#2		Count Mode Ch#1		Count Mode Ch#0	
Byte 2	Count Mode Ch#7		Count Mode Ch#6		Count Mode Ch#5		Count Mode Ch#4	
Byte 3	Count Mode Ch#11		Count Mode Ch#10		Count Mode Ch#9		Count Mode Ch#8	
Byte 4	Count Mode Ch#15		Count Mode Ch#14		Count Mode Ch#13		Count Mode Ch#12	
Byte 5	Count Direction Ch#7	Count Direction Ch#6	Count Direction Ch#5	Count Direction Ch#4	Count Direction Ch#3	Count Direction Ch#2	Count Direction Ch#1	Count Direction Ch#0

Byte 6	Count Direction Ch#15	Count Direction Ch#14	Count Direction Ch#13	Count Direction Ch#12	Count Direction Ch#11	Count Direction Ch#10	Count Direction Ch#9	Count Direction Ch#8
--------	-----------------------------	-----------------------------	-----------------------------	-----------------------------	-----------------------------	-----------------------------	----------------------------	----------------------------

Data description:

32Bit Data Format: Byte transfer order of Channel count value (Default: 0)

0: AB-CD

1: BA-DC

2: CD-AB

3: DC-BA

Storage Function: Storage Function is supported or not, read only, and this value is the actual value of the module when uploading device parameters.

0: storage is not supported

1: storage is supported

Storage Enable: Storage enable, when the Storage Function enables, the IO module will save the count value in real time to non-volatile memory, and load the last saved count value on the next power on. (Default: 1)

0: Disabled

1: Enable

Count Mode Ch# (0-15): Count mode of the input channel. (Default: 0)

0: rising edge count

1: falling edge count

2: double edge count

Count Direction Ch# (0-15): The counting direction of the input channel. (Default: 0)

0: count up

1: count down

A Dimension drawing

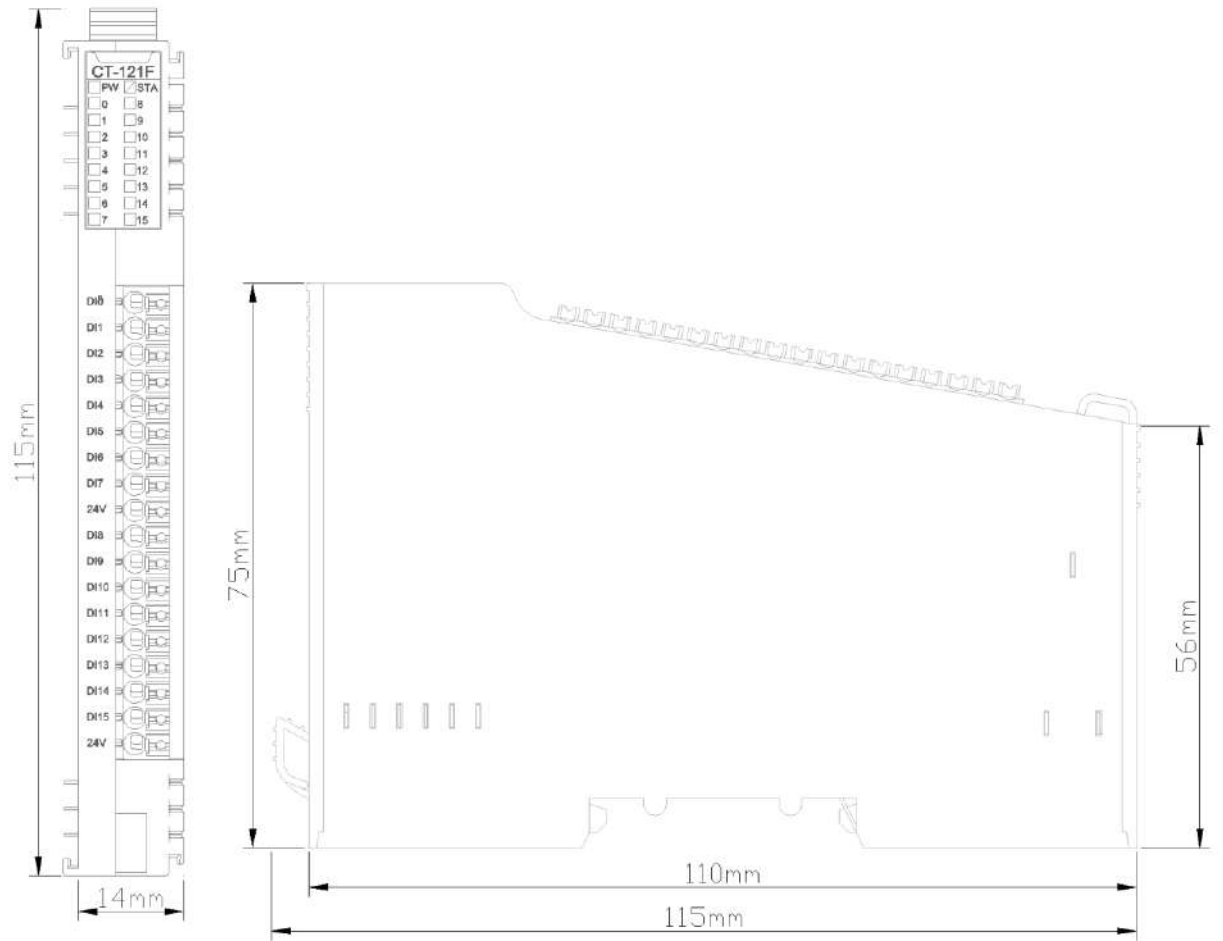

CT-1228 8 channels digital input/24VDC/NPN

1 Module features

- ◆ The module supports 8 channels digital input, and the input low level is valid. It could support NPN sensor.
- ◆ The module could collect digital output signal of field equipment (dry contact or active output).
- ◆ The module could be accessed to 2-wire or 3-wire digital sensor.
- ◆ The internal bus and field input of the module use opto-isolator.
- ◆ The module supports the input signal holding function, and the holding time can be set.
- ◆ The module carries 8 digital input channels with LED indicator on each channel.
- ◆ Supports counting function after adding counting sub-module.
- ◆ Each input channel of the module supports a 32-bit counter with the counting frequency $< 200\text{Hz}$.
- ◆ The module could be set the digital signal input filtering time and the byte transmission order of the counter.
- ◆ Each channel of the module could be set the counting mode and counting direction independently.

2 Technical parameters

General Parameters	
Power Consumption	Max.85mA@5.0VDC
Isolation	I/O to internal bus: opto-couple isolation (3KVrms)
Field Power	Nominal:24VDC, Range:20.4-28.8VDC
Wiring	Max.: AWG 18 Min.: AWG 24
Installation	35mm DIN-Rail
Size	115*14*75mm
Weight	65g
Environment Specification	
Operating Temperature of Horizontal Installation	-35°C~70°C
Operating Temperature of Vertical Installation	-35°C~60°C
Relative Humidity	< 95%RH (No Condensation)
Storage Temperature	-40°C~85°C
Storage Humidity	< 95%RH (No Condensation)
Manufacturing Test Temperature	-40°C~75°C
Ingress Protection Rating	IP20
Input Parameters	
Channel Number	8 channels input
LED Indicator	8 channels input LED indicator
Turn-on Voltage	Min.0VDC to Max.14VDC
Turn-off Voltage	Max.19VDC
Turn-on Current	Max.5mA/channel@28V
Input Impedance	>7.5kΩ
Input Delay	OFF to ON: Max.3ms ON to OFF: Max.2ms
Filter Time	Default 10ms
Sample Frequency	500Hz
Counter Frequency	<200Hz
Effective pulse width for counting	2.5ms

 **WARNING**

UNEXPECTED EQUIPMENT OPERATION

Do not exceed any of the ratings specified in the environmental and electrical characteristics table.

Failure to follow instructions specified by the manufacturer may result in serious consequences such as death, personal injury, or damage to equipment since the protection provided by the equipment may be impaired.

 **AVERTISSEMENT**

FONCTIONNEMENT INATTENDU DE L'EQUIPEMENT

Ne dépassez aucune évaluation spécifiée dans le tableau de caractéristiques environnementales et électriques..

Le fait de ne pas suivre les instructions peut entraîner une défaillance de la protection fournie par l'équipement, ce qui peut entraîner des conséquences graves, comme des blessures ou des dommages à l'équipement.

3 Hardware interfaces

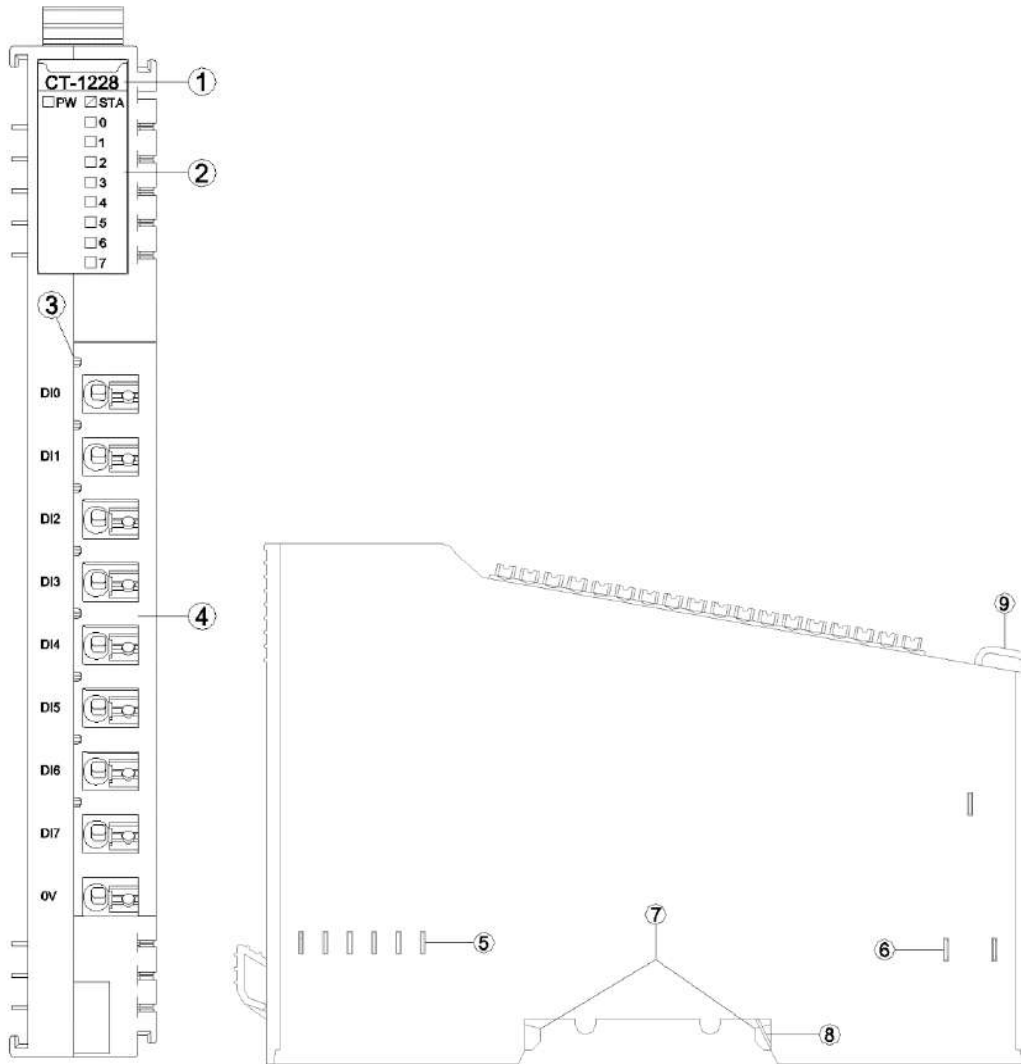

- ① Module Type
- ② State indicator
- ③ Channel indicator
- ④ Wiring Terminal and identification
- ⑤ Internal Bus
- ⑥ Field Power
- ⑦ Buckle
- ⑧ Grounding Spring Sheet

⑨ Fixed Wiring Harness

3.1 LED indicator definition

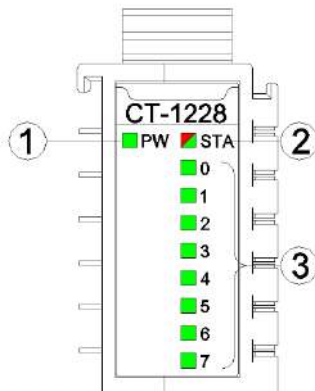

- ① Power LED indicator (green)
- ② Module State LED indicator (red/green)
- ③ Input channel LED indicator (green)

PW Power State (GREEN)	Definition
ON	Internal bus Power Normal
OFF	Internal bus Power Failure
STA Module State (RED/GREEN)	Definition
Green slow flash (2.5Hz)	Module internal bus is not started
Red slow flash (2.5Hz)	Module internal bus offline
ON (GREEN)	Operation normal
Flash(2.5Hz) (RED/GREEN)	Upgrading mode
Flash(10Hz) (RED/GREEN)	Firmware Update
Double Flash (RED)	Module Exception has been soft-restarted
0-7 channel LED indicator	Definition
ON	Input signal valid
OFF	Input signal invalid

! WARNING

UNEXPECTED EQUIPMENT OPERATION

By viewing the PW indicator, could determine the power supply status of a module. If the PW is steady green, the power supply is normal. Otherwise, the module cannot work properly.

When the module is initially powered on, there will be 3S for the backplane bus connection. After the backplane bus is initialized, STA is in the green steady state. If STA is in the green blinking state, it indicates that the backplane bus has not been initialized, and it needs to be powered off and restarted for re-initialization.

STA abnormal working state occurs during the normal operation of the module, please check the

firmware version information of all modules, and consult ODOT technical support for details.
If a module is upgraded, check that all modules are in the normal state after the upgrade.
Otherwise, an exception may occur.

Failure to follow instructions specified by the manufacturer may result in serious consequences such as death, personal injury, or damage to equipment since the protection provided by the equipment may be impaired.

A VERTISSEMENT

FONCTIONNEMENT INATTENDU DE L'ÉQUIPEMENT

En regardant l'état de l'indicateur de PW, jugez l'état d'alimentation du module. Le feu vert PW reste allumé et l'alimentation est normale. Autrement, le module ne fonctionnera pas correctement.

Lorsque le module est alimenté initialement, il y aura 3S pour la connexion de bus de backboard. STA est un état vert permanent après l'initialisation du bus de backboard. Si STA est en état de clignotement vert, cela signifie que l'initialisation du bus de backboard n'est pas passée et doit être redémarrée hors tension et réinitialisée.

L'état de fonctionnement anormal de STA se produit pendant le fonctionnement normal du module, veuillez vérifier les informations de version du firmware de tous les modules, et consulter le support technique ODOT pour plus de détails.

Si le module a une opération de mise à niveau, après l'achèvement de la mise à niveau, le besoin de vérifier que tous les modules sont dans l'état normal avant de courir, sinon il conduira à une exception.

Le fait de ne pas suivre les instructions peut entraîner une défaillance de la protection fournie par l'équipement, ce qui peut entraîner des conséquences graves, comme des blessures ou des dommages à l'équipement.

3.2 Field channel LED indicator (Green)

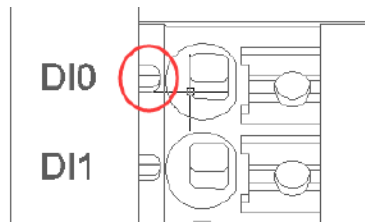

When input signal of input channel is valid, the corresponding field channel LED indicator is on.

3.3 Terminal definition

Terminal Number	Symbol	Description
1	DI0	Signal input
2	DI1	
3	DI2	
4	DI3	
5	DI4	
6	DI5	
7	DI6	
8	DI7	
9	0V	Power V-

WARNING

UNEXPECTED EQUIPMENT OPERATION

The DI channel terminal provides reverse protection.

The FV power supply of the network adapter is normal.

Failure to follow instructions specified by the manufacturer may result in serious consequences such as death, personal injury, or damage to equipment since the protection provided by the equipment may be impaired.

AVERTISSEMENT

FONCTIONNEMENT INATTENDU DE L'EQUIPEMENT

Le terminal de canal d'entrée numérique offre une protection inverse.

L'alimentation FV de l'adaptateur réseau est normale.

Le fait de ne pas suivre les instructions peut entraîner une défaillance de la protection fournie par l'équipement, ce qui peut entraîner des conséquences graves, comme des blessures ou des dommages à l'équipement.

When connecting a cold-pressed terminal, the terminal must be terminated and checked

in strict accordance with the corresponding termination specifications or requirements, and connect the cold-pressed terminal according to the corresponding node serial number. The conductor should use copper conductor and the conductor core should be larger than 0.2mm^2 and smaller than 1mm^2 (AWG18~AWG24). Cold-pressed terminal parameters are as follows:

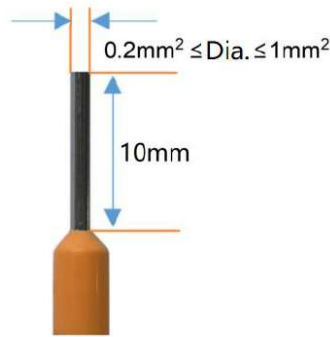

WARNING

UNEXPECTED EQUIPMENT OPERATION

Strip the length of the conductor insulation layer is greater than 10mm to ensure reliable signal connection.

The wire needs to use copper wire and the wire core is greater than or equal to 0.2mm^2 and less than or equal to 1mm^2 to ensure reliable signal connection.

When connecting a cold-press terminal, connect the cold-press terminal strictly in accordance with the corresponding termination specifications or requirements, and connect the cold-press terminal according to the corresponding node serial number.

Do not power on cold-press terminals until they are properly connected or fully locked.

Failure to follow instructions specified by the manufacturer may result in serious consequences such as death, personal injury, or damage to equipment since the protection provided by the equipment may be impaired.

AVERTISSEMENT

FONCTIONNEMENT INATTENDU DE L'EQUIPEMENT

Dépouillez la longueur de la couche isolante du fil plus de 10mm pour assurer la connexion fiable du signal.

Le conducteur doit utiliser le fil de cuivre et le noyau de fil est supérieur ou égal à $0,2\text{ mm}^2$, inférieur ou égal à 1mm^2 , afin d'assurer la connexion fiable du signal.

Lorsque les terminaux de presse à froid sont terminés, ils doivent être terminés et visualisés en stricte conformité avec les spécifications ou les exigences correspondantes et terminés selon le numéro de série de noeud correspondant.

Il est interdit d'activer les bornes à froid avant qu'elles ne soient correctement articulées ou complètement verrouillées.

Le fait de ne pas suivre les instructions peut entraîner une défaillance de la protection fournie par l'équipement, ce qui peut entraîner des conséquences graves, comme des

blessures ou des dommages à l'équipement.

DANGER

FIRE DANGER

Use the correct wiring rules only for the maximum current capacity of the I/O channel and power supply.

Failure to follow instructions specified by the manufacturer may result in serious consequences such as death, personal injury, or damage to equipment since the protection provided by the equipment may be impaired.

WARNING

UNEXPECTED EQUIPMENT OPERATION

Do not exceed any of the ratings specified in the environmental and electrical characteristics table.

Failure to follow instructions specified by the manufacturer may result in serious consequences such as death, personal injury, or damage to equipment since the protection provided by the equipment may be impaired.

AVERTISSEMENT

FONCTIONNEMENT INATTENDU DE L'EQUIPEMENT

Ne dépassez aucune évaluation spécifiée dans le tableau de caractéristiques environnementales et électriques..

Le fait de ne pas suivre les instructions peut entraîner une défaillance de la protection fournie par l'équipement, ce qui peut entraîner des conséquences graves, comme des blessures ou des dommages à l'équipement.

4 Wiring

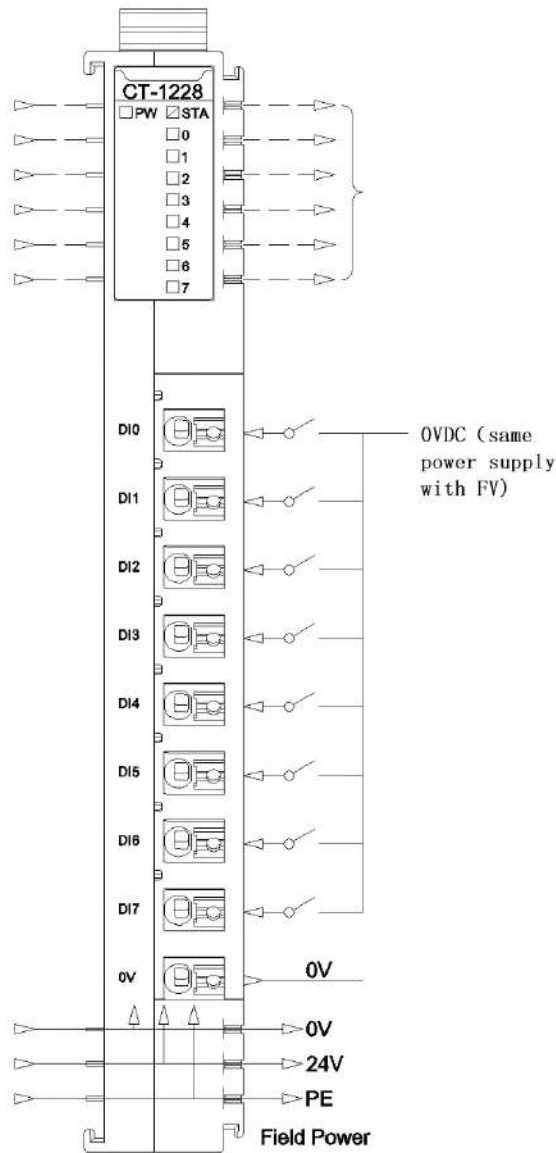

NOTICE

EQUIPMENT INOPERABLE

Do not crimp the spring terminal with more than the maximum pressure specified for the terminal. Otherwise, the resilience of the spring terminal may be damaged and the terminal rebound may be affected.

Do not press the spring terminal with a sharp tool when removing cable from the channel. Otherwise, the spring terminal will be damaged.

Failure to follow these instructions may result in equipment damage.

5 Process data definition

<8DI Input Status> Submodule process data definition

Input data								
Bit No	Bit 7	Bit 6	Bit 5	Bit 4	Bit 3	Bit 2	Bit 1	Bit 0
Byte 0	DI Ch#7	DI Ch#6	DI Ch#5	DI Ch#4	DI Ch#3	DI Ch#2	DI Ch#1	DI Ch#0

Data description:

DI Ch#(0-7): When the corresponding channel input signal is valid, the bit is 1, and when the input is invalid, it is 0.

0: Input signal invalid

1: Input signal valid

<8DI Counter Submodule> Submodule process data definition:

Input data								
Bit No	Bit 7	Bit 6	Bit 5	Bit 4	Bit 3	Bit 2	Bit 1	Bit 0
Byte 0	Counter Value Ch#0							
Byte 1								
Byte 2								
Byte 3								
Byte 4	Counter Value Ch#1							
Byte 5								
Byte 6								
Byte 7								
Byte 8	Counter Value Ch#2							
Byte 9								
Byte 10								
Byte 11								
Byte 12	Counter Value Ch#3							
Byte 13								
Byte 14								
Byte 15								
Byte 16	Counter Value Ch#4							
Byte 17								
Byte 18								
Byte 19								
Byte 20	Counter Value Ch#5							
Byte 21								
Byte 22								
Byte 23								
Byte 24	Counter Value Ch#6							
Byte 25								
Byte 26								

Byte 27								
Byte 28	Counter Value Ch#7							
Byte 29								
Byte 30								
Byte 31								
Output data								
Bit No	Bit 7	Bit 6	Bit 5	Bit 4	Bit 3	Bit 2	Bit 1	Bit 0
Byte 0	Counter Reset Ch#7	Counter Reset Ch#6	Counter Reset Ch#5	Counter Reset Ch#4	Counter Reset Ch#3	Counter Reset Ch#2	Counter Reset Ch#1	Counter Reset Ch#0

Data description:

Counter Value Ch#(0-7): Count value, 32-bit unsigned integer, automatically zeroing after overflow.

Counter Reset Ch#(0-7): When the data bit changes from 0 to 1 (rising edge), the input counter of the corresponding channel is cleared.

Note: the maximum counting frequency of the input channel is 200Hz. When the input signal exceeds this frequency, the counting result may be inconsistent with the actual value.

6 Configuration parameter definitions

<8DI Input Status> Submodule configuration parameter definition

Configuration parameters								
Bit No	Bit 7	Bit 6	Bit 5	Bit 4	Bit 3	Bit 2	Bit 1	Bit 0
Byte 0	Input Filtering Time(ms)							
Byte 1								
Byte 2	Reserved					Input Holding Time(ms)		

Data description:

Input Filtering Time(ms): Input filter time of Channel (ms) (Default: 10)

Input Holding Time(ms): Signal input holding time of Channel (ms) (Default:0)

0: Disable

1: 200ms

2: 500ms

3: 1000ms

4: 1500ms

5: 2000ms

6: 3000ms

7: 5000ms

<8DI Counter Submodule> Submodule configuration parameter definition

Configuration parameters									
Bit No	Bit 7	Bit 6	Bit 5	Bit 4	Bit 3	Bit 2	Bit 1	Bit 0	
Byte 0	Reserved				Storage Enable	Storage Function	32Bit Data Format		
Byte 1	Count Mode Ch#3		Count Mode Ch#2		Count Mode Ch#1		Count Mode Ch#0		
Byte 2	Count Mode Ch#7		Count Mode Ch#6		Count Mode Ch#5		Count Mode Ch#4		
Byte 3...4	Reserved								
Byte 5	Count Direction Ch#7	Count Direction Ch#6	Count Direction Ch#5	Count Direction Ch#4	Count Direction Ch#3	Count Direction Ch#2	Count Direction Ch#1	Count Direction Ch#0	

Data description:

32Bit Data Format: Byte transfer order of Channel count value (Default: 0)

0: AB-CD

1: BA-DC

2: CD-AB

3: DC-BA

Storage Function: Storage Function is supported or not, read only, and this value is the actual value of the module when uploading device parameters.

0: storage is not supported

1: storage is supported

Storage Enable: Storage enable, when the Storage Function enables, the IO module will save the count value in real time to non-volatile memory, and load the last saved count value on the next power on. (Default: 1)

0: Disabled

1: Enable

Count Mode Ch#(0-7): Count mode of the input channel. (Default: 0)

0: rising edge count

1: falling edge count

2: double edge count

Count Direction Ch#(0-7): The counting direction of the input channel. (Default: 0)

0: count up

1: count down

A Dimension drawing

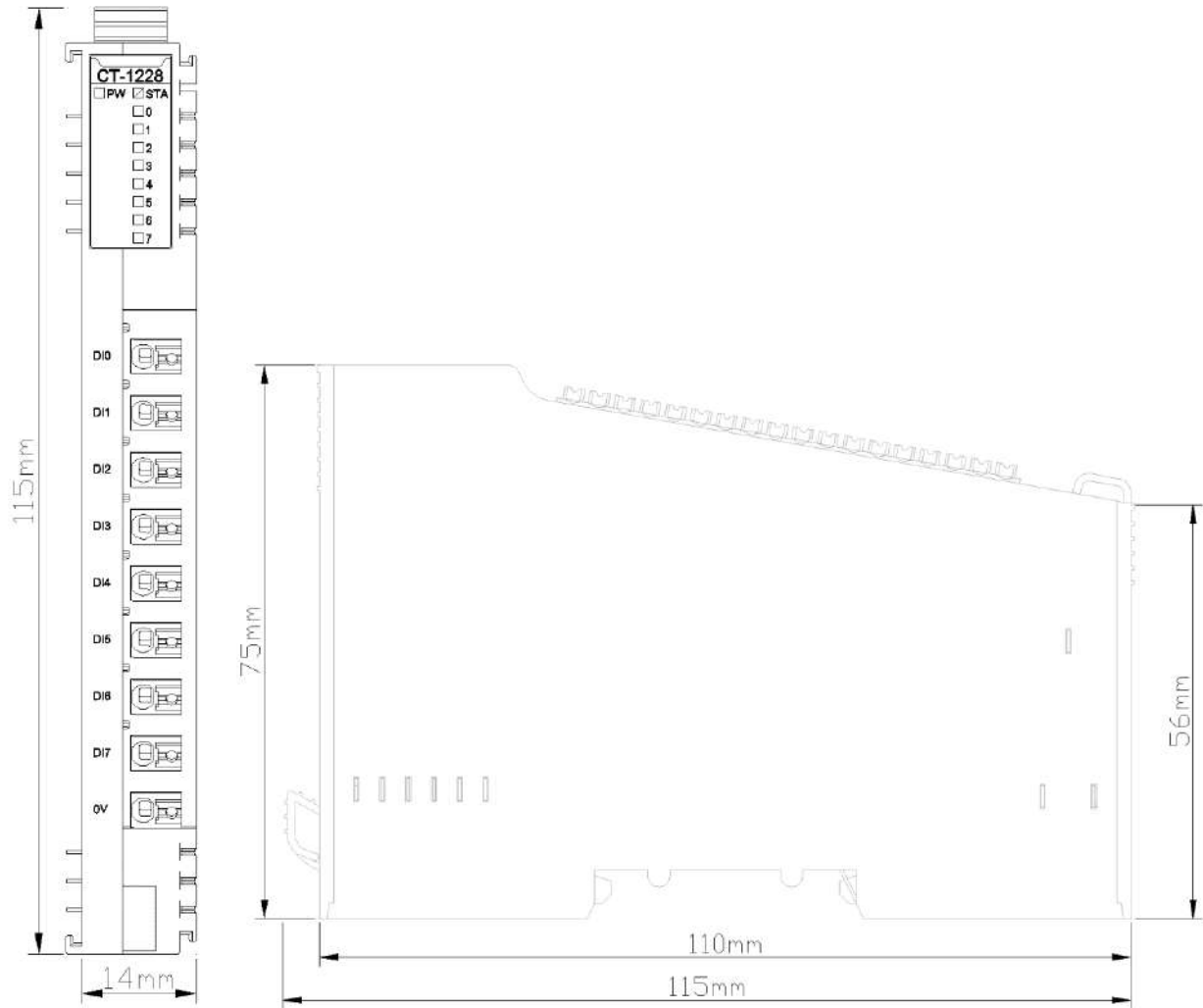

CT-122F 16 channels digital input/24VDC/NPN

1 Module features

- ◆ The Module supports 16 channels digital input, supports source input, the input voltage is 0V and the input low level is valid.
- ◆ The module could collect the digital output signal of field equipment (dry contact or active output).
- ◆ The module could be connected to a 2-wire or 3-wire digital sensor.
- ◆ The internal bus of the module and field input are isolated by optocoupler.
- ◆ The module supports input signal holding function, holding time can be set.
- ◆ The module carries with 16 digital input channel LED indicator.
- ◆ After adding counting submodule, the counting function is effective.
- ◆ Each input channel of the module supports 32-bit counter with counting frequency <200Hz.
- ◆ The module could be set the digital signal input filter time and counter byte transmission sequence.
- ◆ Each channel of the module could be set the counting mode and counting direction independently.

2 Technical parameters

General Parameters	
Power Consumption	Max.60mA@5.0VDC
Isolation	I/O to internal bus: opto-couple isolation (3KVrms)
Field Power	Nominal:24VDC, Range:20.4-28.8VDC
Wiring	Max.: AWG 18 Min.: AWG 24
Installation	35mm DIN-Rail
Size	115*14*75mm
Weight	65g
Environment Specification	
Operating Temperature of Horizontal Installation	-35°C~70°C
Operating Temperature of Vertical Installation	-35°C~60°C
Relative Humidity	< 95%RH (No Condensation)
Storage Temperature	-40°C~85°C
Storage Humidity	< 95%RH (No Condensation)
Manufacturing Test Temperature	-40°C~75°C
Ingress Protection Rating	IP20
Input Parameters	
Channel Number	16 channels source input
LED Indicator	16 channels input LED indicator
Turn-on Voltage	Min.0VDC to Max.14VDC
Turn-off Voltage	Max.19VDC
Turn-on Current	Max.5mA/channel@28V
Input Impedance	>7.5kΩ
Input Delay	OFF to ON :Max.3ms ON to OFF :Max.2ms
Filter Time	Default 10ms
Sample Frequency	500Hz
Counter Frequency	<200Hz
Effective pulse width for counting	2.5ms

 **WARNING**

UNEXPECTED EQUIPMENT OPERATION

Do not exceed any of the ratings specified in the environmental and electrical characteristics table.

Failure to follow instructions specified by the manufacturer may result in serious consequences such as death, personal injury, or damage to equipment since the protection provided by the equipment may be impaired.

 **AVERTISSEMENT**

FONCTIONNEMENT INATTENDU DE L'EQUIPEMENT

Ne dépassez aucune évaluation spécifiée dans le tableau de caractéristiques environnementales et électriques..

Le fait de ne pas suivre les instructions peut entraîner une défaillance de la protection fournie par l'équipement, ce qui peut entraîner des conséquences graves, comme des blessures ou des dommages à l'équipement.

3 Hardware interfaces

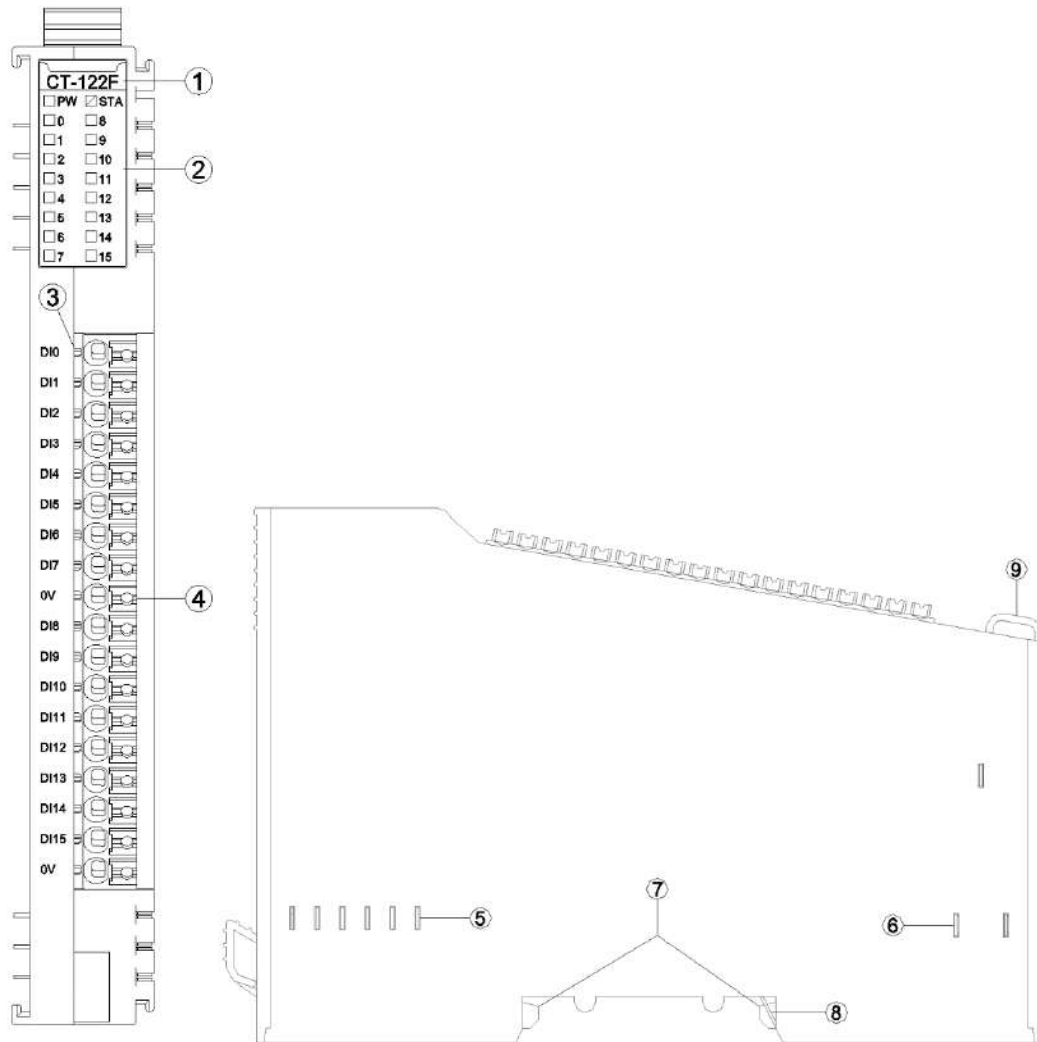

- ① Module Type
- ② State indicator
- ③ Channel indicator
- ④ Wiring Terminal and identification
- ⑤ Internal Bus
- ⑥ Field Power
- ⑦ Buckle
- ⑧ Grounding Spring Sheet
- ⑨ Fixed Wiring Harness

3.1 LED indicator definition

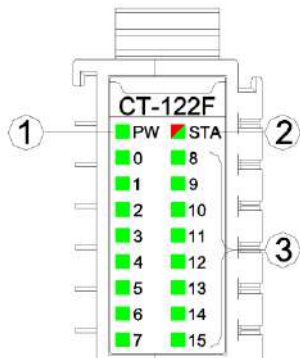

- ① Power LED indicator (green)
- ② Module State LED indicator (red/green)
- ③ Input channel LED indicator (green)

PW Power State (GREEN)	Definition
ON	Internal bus Power Normal
OFF	Internal bus Power Failure
STA Module State (RED/GREEN)	Definition
Green slow flash (2.5Hz)	Module internal bus is not started
Red slow flash (2.5Hz)	Module internal bus offline
ON (GREEN)	Operation normal
Flash(2.5Hz) (RED/GREEN)	Upgrading mode
Flash(10Hz) (RED/GREEN)	Firmware Update
Double Flash (RED)	Module Exception has been soft-restarted
0-15 channel indicator light	Definition
ON	Input signal valid
OFF	Input signal invalid

! WARNING

UNEXPECTED EQUIPMENT OPERATION

By viewing the PW indicator, could determine the power supply status of a module. If the PW is steady green, the power supply is normal. Otherwise, the module cannot work properly.

When the module is initially powered on, there will be 3S for the backplane bus connection. After the backplane bus is initialized, STA is in the green steady state. If STA is in the green blinking state, it indicates that the backplane bus has not been initialized, and it needs to be powered off and restarted for re-initialization.

STA abnormal working state occurs during the normal operation of the module, please check the firmware version information of all modules, and consult ODOT technical support for details.

If a module is upgraded, check that all modules are in the normal state after the upgrade. Otherwise, an exception may occur.

Failure to follow instructions specified by the manufacturer may result in serious consequences such as death, personal injury, or damage to equipment since the protection provided by the equipment may be impaired.

⚠️ Avertissement

FONCTIONNEMENT INATTENDU DE L'EQUIPEMENT

En regardant l'état de l'indicateur de PW, jugez l'état d'alimentation du module. Le feu vert PW reste allumé et l'alimentation est normale. Autrement, le module ne fonctionnera pas correctement.

Lorsque le module est alimenté initialement, il y aura 3S pour la connexion de bus de backboard. STA est un état vert permanent après l'initialisation du bus de backboard. Si STA est en état de clignotement vert, cela signifie que l'initialisation du bus de backboard n'est pas passée et doit être redémarrée hors tension et réinitialisée.

L'état de fonctionnement anormal de STA se produit pendant le fonctionnement normal du module, veuillez vérifier les informations de version du firmware de tous les modules, et consulter le support technique ODOT pour plus de détails.

Si le module a une opération de mise à niveau, après l'achèvement de la mise à niveau, le besoin de vérifier que tous les modules sont dans l'état normal avant de courir, sinon il conduira à une exception.

Le fait de ne pas suivre les instructions peut entraîner une défaillance de la protection fournie par l'équipement, ce qui peut entraîner des conséquences graves, comme des blessures ou des dommages à l'équipement.

3.2 Field channel LED indicator (Green)

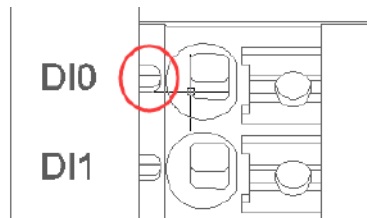

When input signal of input channel is valid, the corresponding field channel LED indicator is on.

3.3 Terminal definition

Terminal Number	Symbol	Description
1	DI0	Signal input
2	DI1	
3	DI2	
4	DI3	
5	DI4	
6	DI5	
7	DI6	
8	DI7	
9	0V	Power V-
10	DI8	Signal input
11	DI9	
12	DI10	
13	DI11	
14	DI12	
15	DI13	
16	DI14	
17	DI15	Power output V-
18	0V	

WARNING

UNEXPECTED EQUIPMENT OPERATION

The DI channel terminal provides reverse protection.

The FV power supply of the network adapter is normal.

Failure to follow instructions specified by the manufacturer may result in serious consequences such as death, personal injury, or damage to equipment since the protection provided by the equipment may be impaired.

AVERTISSEMENT

FONCTIONNEMENT INATTENDU DE L'EQUIPEMENT

Le terminal de canal d'entrée numérique offre une protection inverse.

L'alimentation FV de l'adaptateur réseau est normale.

Le fait de ne pas suivre les instructions peut entraîner une défaillance de la protection fournie par l'équipement, ce qui peut entraîner des conséquences graves, comme des blessures ou des dommages à l'équipement.

When connecting a cold-pressed terminal, the terminal must be terminated and checked in strict accordance with the corresponding termination specifications or requirements, and connect the cold-pressed terminal according to the corresponding node serial number. The conductor should use copper conductor and the conductor core should be larger than 0.2mm^2 and smaller than 1mm^2 (AWG18~AWG24). Cold-pressed terminal parameters are as follows:

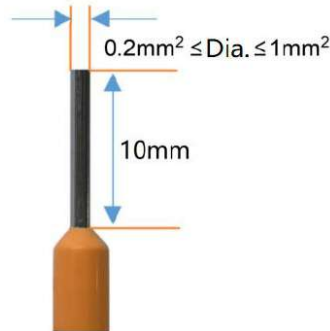

! WARNING

UNEXPECTED EQUIPMENT OPERATION

Strip the length of the conductor insulation layer is greater than 10mm to ensure reliable signal connection.

The wire needs to use copper wire and the wire core is greater than or equal to 0.2mm^2 and less than or equal to 1mm^2 to ensure reliable signal connection.

When connecting a cold-press terminal, connect the cold-press terminal strictly in accordance with the corresponding termination specifications or requirements, and connect the cold-press terminal according to the corresponding node serial number.

Do not power on cold-press terminals until they are properly connected or fully locked.

Failure to follow instructions specified by the manufacturer may result in serious consequences such as death, personal injury, or damage to equipment since the protection provided by the equipment may be impaired.

! AVERTISSEMENT

FONCTIONNEMENT INATTENDU DE L'EQUIPEMENT

Dépouillez la longueur de la couche isolante du fil plus de 10mm pour assurer la connexion fiable du signal.

Le conducteur doit utiliser le fil de cuivre et le noyau de fil est supérieur ou égal à $0,2\text{ mm}^2$, inférieur ou égal à 1mm^2 , afin d'assurer la connexion fiable du signal.

Lorsque les terminaux de presse à froid sont terminés, ils doivent être terminés et visualisés en stricte conformité avec les spécifications ou les exigences correspondantes et terminés selon le numéro de série de noeud correspondant.

Il est interdit d'activer les bornes à froid avant qu'elles ne soient correctement articulées ou complètement verrouillées.

Le fait de ne pas suivre les instructions peut entraîner une défaillance de la protection

fournie par l'équipement, ce qui peut entraîner des conséquences graves, comme des blessures ou des dommages à l'équipement.

DANGER

FIRE DANGER

Use the correct wiring rules only for the maximum current capacity of the I/O channel and power supply.

Failure to follow instructions specified by the manufacturer may result in serious consequences such as death, personal injury, or damage to equipment since the protection provided by the equipment may be impaired.

WARNING

UNEXPECTED EQUIPMENT OPERATION

Do not exceed any of the ratings specified in the environmental and electrical characteristics table.

Failure to follow instructions specified by the manufacturer may result in serious consequences such as death, personal injury, or damage to equipment since the protection provided by the equipment may be impaired.

AVERTISSEMENT

FONCTIONNEMENT INATTENDU DE L'EQUIPEMENT

Ne dépassez aucune évaluation spécifiée dans le tableau de caractéristiques environnementales et électriques..

Le fait de ne pas suivre les instructions peut entraîner une défaillance de la protection fournie par l'équipement, ce qui peut entraîner des conséquences graves, comme des blessures ou des dommages à l'équipement.

4 Wiring

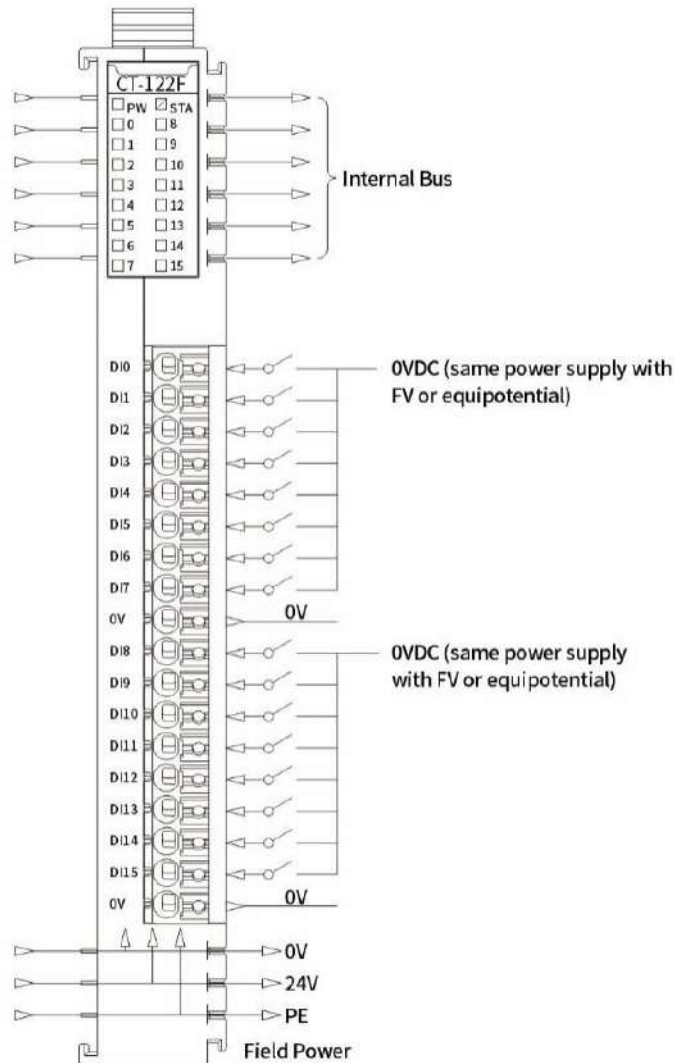

NOTICE

EQUIPMENT INOPERABLE

Do not crimp the spring terminal with more than the maximum pressure specified for the terminal. Otherwise, the resilience of the spring terminal may be damaged and the terminal rebound may be affected.

Do not press the spring terminal with a sharp tool when removing cable from the channel. Otherwise, the spring terminal will be damaged.

Failure to follow these instructions may result in equipment damage.

5 Process data definition

<16DI Input State> Submodule process data definition

Input data								
Bit No	Bit 7	Bit 6	Bit 5	Bit 4	Bit 3	Bit 2	Bit 1	Bit 0
Byte 0	DI Ch#7	DI Ch#6	DI Ch#5	DI Ch#4	DI Ch#3	DI Ch#2	DI Ch#1	DI Ch#0
Byte 1	DI Ch#15	DI Ch#14	DI Ch#13	DI Ch#12	DI Ch#11	DI Ch#10	DI Ch#9	DI Ch#8

Data description:

DI Ch#(0-15): When the corresponding channel input signal is valid, the bit is 1, and when the input is invalid, it is 0.

0: Input signal invalid

1: Input signal valid

<16DI Counter Submodule> Submodule process data definition:

Input data								
Bit No	Bit 7	Bit 6	Bit 5	Bit 4	Bit 3	Bit 2	Bit 1	Bit 0
Byte 0	Counter Value Ch#0							
Byte 1								
Byte 2								
Byte 3								
Byte 4	Counter Value Ch#1							
Byte 5								
Byte 6								
Byte 7								
Byte 8	Counter Value Ch#2							
Byte 9								
Byte 10								
Byte 11								
Byte 12	Counter Value Ch#3							
Byte 13								
Byte 14								
Byte 15								
Byte 16	Counter Value Ch#4							
Byte 17								
Byte 18								
Byte 19								
Byte 20	Counter Value Ch#5							
Byte 21								
Byte 22								

Byte 23								
Byte 24								
Byte 25	Counter Value Ch#6							
Byte 26								
Byte 27								
Byte 28								
Byte 29	Counter Value Ch#7							
Byte 30								
Byte 31								
Byte 32								
Byte 33	Counter Value Ch#8							
Byte 34								
Byte 35								
Byte 36								
Byte 37	Counter Value Ch#9							
Byte 38								
Byte 39								
Byte 40								
Byte 41	Counter Value Ch#10							
Byte 42								
Byte 43								
Byte 44								
Byte 45	Counter Value Ch#11							
Byte 46								
Byte 47								
Byte 48								
Byte 49	Counter Value Ch#12							
Byte 50								
Byte 51								
Byte 52								
Byte 53	Counter Value Ch#13							
Byte 54								
Byte 55								
Byte 56								
Byte 57	Counter Value Ch#14							
Byte 58								
Byte 59								
Byte 60								
Byte 61	Counter Value Ch#15							
Byte 62								
Byte 63								
Byte 63								
Output data								
Bit No	Bit 7	Bit 6	Bit 5	Bit 4	Bit 3	Bit 2	Bit 1	Bit 0
Byte 0	Counter Reset Ch#7	Counter Reset Ch#6	Counter Reset Ch#5	Counter Reset Ch#4	Counter Reset Ch#3	Counter Reset Ch#2	Counter Reset Ch#1	Counter Reset Ch#0

Byte 1	Counter Reset Ch#15	Counter Reset Ch#14	Counter Reset Ch#13	Counter Reset Ch#12	Counter Reset Ch#11	Counter Reset Ch#10	Counter Reset Ch#9	Counter Reset Ch#8
--------	---------------------------	---------------------------	---------------------------	---------------------------	---------------------------	---------------------------	--------------------------	--------------------------

Data description:

Counter Value Ch#(0-15): Count value, 32-bit unsigned integer, automatically zeroing after overflow.

Counter Reset Ch#(0-15): When the data bit changes from 0 to 1 (rising edge), the input counter of the corresponding channel is cleared.

Note: the maximum counting frequency of the input channel is 200Hz. When the input signal exceeds this frequency, the counting result may be inconsistent with the actual value.

6 Configuration parameter definitions

<16DI Input State> Submodule configuration parameter definition

Configuration parameters								
Bit No	Bit 7	Bit 6	Bit 5	Bit 4	Bit 3	Bit 2	Bit 1	Bit 0
Byte 0	Input Filtering Time(ms)							
Byte 1								
Byte 2	Reserved					Input Holding Time(ms)		

Data description:

Input Filtering Time(ms): Input filter time of Channel (ms) (Default: 10)

Input Holding Time(ms): Signal input holding time of Channel (ms) (Default:0)

- 0: Disable
- 1: 200ms
- 2: 500ms
- 3: 1000ms
- 4: 1500ms
- 5: 2000ms
- 6: 3000ms
- 7: 5000ms

<16DI Counter Submodule> Submodule configuration parameter definition

Configuration parameters									
Bit No	Bit 7	Bit 6	Bit 5	Bit 4	Bit 3	Bit 2	Bit 1	Bit 0	
Byte 0	Reserved				Storage Enable	Storage Function	32Bit Data Format		
Byte 1	Count Mode Ch#3		Count Mode Ch#2		Count Mode Ch#1		Count Mode Ch#0		
Byte 2	Count Mode Ch#7		Count Mode Ch#6		Count Mode Ch#5		Count Mode Ch#4		
Byte 3	Count Mode Ch#11		Count Mode Ch#10		Count Mode Ch#9		Count Mode Ch#8		
Byte 4	Count Mode Ch#15		Count Mode Ch#14		Count Mode Ch#13		Count Mode Ch#12		
Byte 5	Count Direction Ch#7	Count Direction Ch#6	Count Direction Ch#5	Count Direction Ch#4	Count Direction Ch#3	Count Direction Ch#2	Count Direction Ch#1	Count Direction Ch#0	

Byte 6	Count Direction Ch#15	Count Direction Ch#14	Count Direction Ch#13	Count Direction Ch#12	Count Direction Ch#11	Count Direction Ch#10	Count Direction Ch#9	Count Direction Ch#8
--------	-----------------------------	-----------------------------	-----------------------------	-----------------------------	-----------------------------	-----------------------------	----------------------------	----------------------------

Data description:

32Bit Data Format: Byte transfer order of Channel count value (Default: 0)

0: AB-CD

1: BA-DC

2: CD-AB

3: DC-BA

Storage Function: Storage Function is supported or not, read only, and this value is the actual value of the module when uploading device parameters.

0: storage is not supported

1: storage is supported

Storage Enable: Storage enable, when the Storage Function enables, the IO module will save the count value in real time to non-volatile memory, and load the last saved count value on the next power on. (Default: 1)

0: Disabled

1: Enable

Count Mode Ch# (0-15): Count mode of the input channel. (Default: 0)

0: rising edge count

1: falling edge count

2: double edge count

Count Direction Ch# (0-15): The counting direction of the input channel. (Default: 0)

0: count up

1: count down

A Dimension drawing

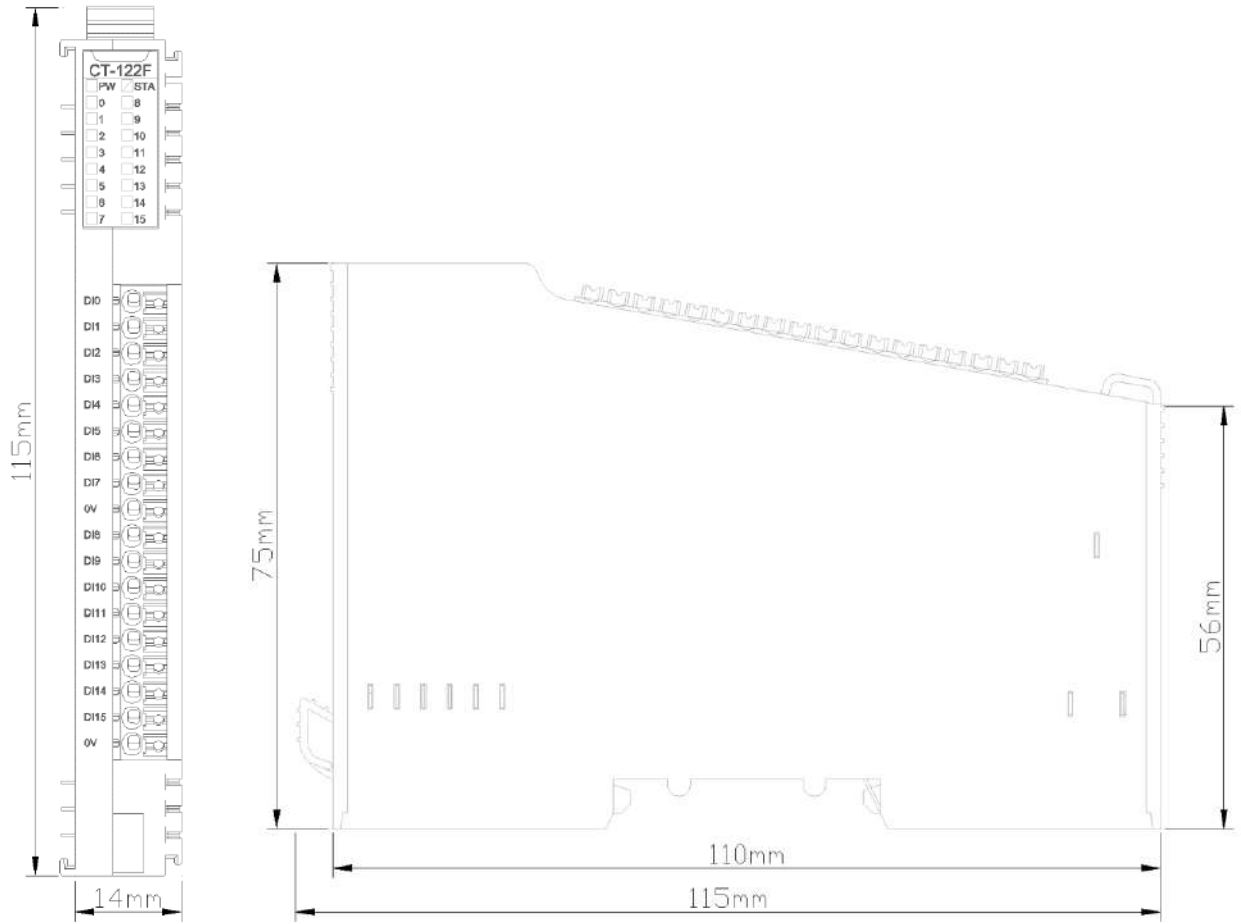

CT-124H 32 channels digital input/24VDC/PNP or NPN

1 Module features

- ◆ The module supports 32 channels digital input, it supports sink input and the input high level is valid as it could support PNP sensor; it also supports source input and the input low level is valid as it could support NPN sensor.
- ◆ The module could collect the digital output signal of field equipment (dry contact or active output).
- ◆ The module could be connected to 2-wire or 3-wire digital sensor.
- ◆ The internal bus of the module and field input are isolated by optocoupler.
- ◆ The module supports input signal holding function, holding time can be set.
- ◆ After adding counting submodule, the counting function is effective.
- ◆ Each input channel of the module supports 32-bit counter with counting frequency <200Hz.
- ◆ The module could be set the digital signal input filter time and counter byte transmission sequence.
- ◆ Each channel of the module could be set the counting mode and counting direction independently.

1 Technical parameters

General Parameters	
Power Consumption	Max.70mA@5.0VDC
Isolation	I/O to internal bus: opto-couple isolation (3KVrms)
Field Power	Nominal:24VDC, Range:20.4-28.8VDC
Wiring	34P male connector 2.54mm Pin header
Installation	35mm DIN-Rail
Size	115*14*75mm
Weight	65g
Vibration Resistance	Comply with IEC 61131-2 and EC 60068-2-6
Impact resistance	Comply with IEC 61131-2 and IEC 60068-2-27
EMC Performance	Comply with IEC 61131-2 and IEC 61000-4
Environment Specification	
Operating Temperature of Horizontal Installation	-35°C~70°C
Operating Temperature of Vertical Installation	-35°C~60°C
Relative Humidity	< 95%RH (No Condensation)
Storage Temperature	-40°C~85°C
Storage Humidity	< 95%RH (No Condensation)
Manufacturing Test Temperature	-40°C~75°C
Ingress Protection Rating	IP20
Input Parameters	
Channel Number	32 channels input
LED Indicator	32 channels input LED indicator
Turn-on Voltage	High input: Min.10VDC to Max.28VDC (Common Terminal:0VDC) Low input: Min.0VDC to Max.14VDC (Common Terminal:24VDC)
Turn-off Voltage	High input:Max.5VDC (Common Terminal:0VDC) Low input: Min.19VDC (Common Terminal:24VDC)
Turn-on Current	Max.5mA/channel@28V
Input Impedance	>7.5kΩ
Input Delay	OFF to ON: Max.3ms ON to OFF: Max.2ms
Filter Time	Default 10ms
Sample Frequency	500Hz
Counter Frequency	<200Hz
Effective pulse width for counting	2.5ms

 **WARNING**

UNEXPECTED EQUIPMENT OPERATION

Do not exceed any of the ratings specified in the environmental and electrical characteristics table.

Failure to follow instructions specified by the manufacturer may result in serious consequences such as death, personal injury, or damage to equipment since the protection provided by the equipment may be impaired.

 **AVERTISSEMENT**

FONCTIONNEMENT INATTENDU DE L'EQUIPEMENT

Ne dépassez aucune évaluation spécifiée dans le tableau de caractéristiques environnementales et électriques..

Le fait de ne pas suivre les instructions peut entraîner une défaillance de la protection fournie par l'équipement, ce qui peut entraîner des conséquences graves, comme des blessures ou des dommages à l'équipement.

3 Hardware interfaces

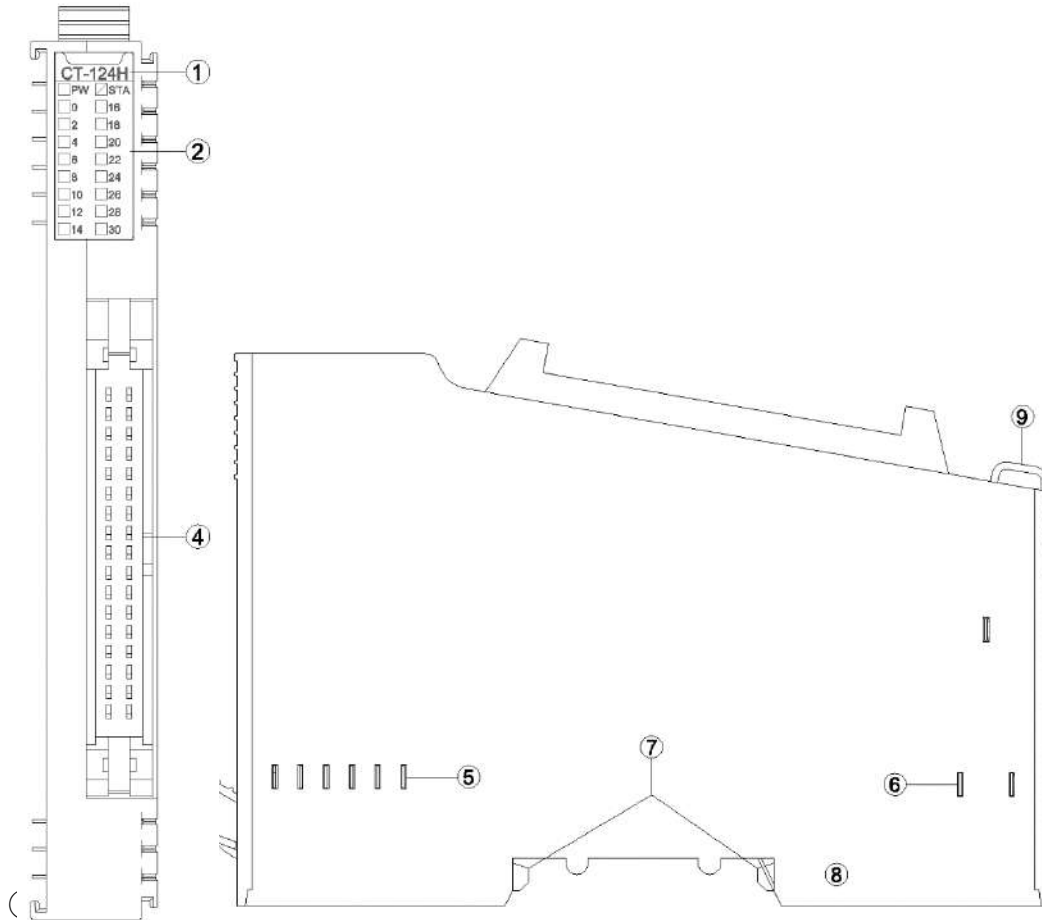

- ② State indicator
- ④ 34P male connector
- ⑤ Internal Bus
- ⑥ Field Power
- ⑦ Buckle
- ⑧ Grounding Spring Sheet
- ⑨ Fixed Wiring Harness

3.1 LED indicator definition

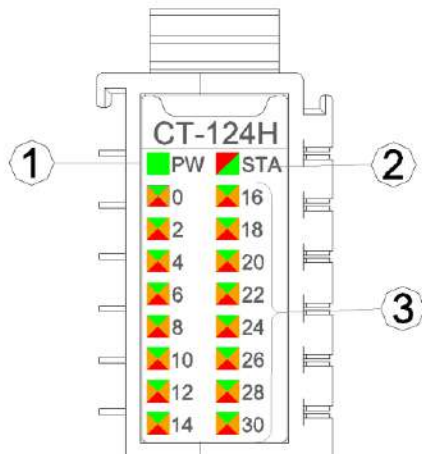

- ① Power LED indicator (green)
- ② Module State LED indicator (red/green)
- ③ Input channel LED indicator (green/red/orange)

PW Power State	Definition
ON	Internal bus Power Normal
OFF	Internal bus Power Failure
STA Module State Indicator	Definition
Green slow flash (2.5Hz)	Module internal bus is not started
Red slow flash (2.5Hz)	Module internal bus offline
ON (GREEN)	Operation normal
Flash(2.5Hz)(RED/GREEN)	Upgrading mode
Flash(10Hz) (RED/GREEN)	Firmware Update
Double Flash (RED)	Module Exception has been soft-restarted
0-31 channel indicator light	Definition
ON (GREEN)	Indicates that the input channel signal is valid
ON (RED)	Indicates that the input channel +1 signal is valid
ON (ORANGE)	Indicates that the input channel and channel +1 signal are valid
OFF	Input signal is invalid

! WARNING

UNEXPECTED EQUIPMENT OPERATION

By viewing the PW indicator, could determine the power supply status of a module. If the PW is steady green, the power supply is normal. Otherwise, the module cannot work properly.

When the module is initially powered on, there will be 3S for the backplane bus connection. After the backplane bus is initialized, STA is in the green steady state. If STA is in the green blinking

state, it indicates that the backplane bus has not been initialized, and it needs to be powered off and restarted for re-initialization.

STA abnormal working state occurs during the normal operation of the module, please check the firmware version information of all modules, and consult ODOT technical support for details.

If a module is upgraded, check that all modules are in the normal state after the upgrade. Otherwise, an exception may occur.

Failure to follow instructions specified by the manufacturer may result in serious consequences such as death, personal injury, or damage to equipment since the protection provided by the equipment may be impaired.

AVERTISSEMENT

FONCTIONNEMENT INATTENDU DE L'ÉQUIPEMENT

En regardant l'état de l'indicateur de PW, jugez l'état d'alimentation du module. Le feu vert PW reste allumé et l'alimentation est normale. Autrement, le module ne fonctionnera pas correctement.

Lorsque le module est alimenté initialement, il y aura 3S pour la connexion de bus de backboard. STA est un état vert permanent après l'initialisation du bus de backboard. Si STA est en état de clignotement vert, cela signifie que l'initialisation du bus de backboard n'est pas passée et doit être redémarrée hors tension et réinitialisée.

L'état de fonctionnement anormal de STA se produit pendant le fonctionnement normal du module, veuillez vérifier les informations de version du firmware de tous les modules, et consulter le support technique ODOT pour plus de détails.

Si le module a une opération de mise à niveau, après l'achèvement de la mise à niveau, le besoin de vérifier que tous les modules sont dans l'état normal avant de courir, sinon il conduira à une exception.

Le fait de ne pas suivre les instructions peut entraîner une défaillance de la protection fournie par l'équipement, ce qui peut entraîner des conséquences graves, comme des blessures ou des dommages à l'équipement.

3.2 Terminal definition

Description	Symbol	Terminal Number	Terminal Number	Symbol	Description
Signal input	DI0	1	18	DI16	Signal input
	DI1	2	19	DI17	
	DI2	3	20	DI18	
	DI3	4	21	DI19	
	DI4	5	22	DI20	
	DI5	6	23	DI21	
	DI6	7	24	DI22	
	DI7	8	25	DI23	
	DI8	9	26	DI24	
	DI9	10	27	DI25	
	DI10	11	28	DI26	
	DI11	12	29	DI27	
	DI12	13	30	DI28	
	DI13	14	31	DI29	
	DI14	15	32	DI30	
DI15	16	33	DI31		
0V or 24V	COMA	17	34	COMB	0V or 24V

WARNING

UNEXPECTED EQUIPMENT OPERATION

The DI channel terminal provides reverse protection.

The FV power supply of the network adapter is normal.

Failure to follow instructions specified by the manufacturer may result in serious consequences such as death, personal injury, or damage to equipment since the protection provided by the equipment may be impaired.

AVERTISSEMENT

FONCTIONNEMENT INATTENDU DE L'EQUIPEMENT

Le terminal de canal d'entrée numérique offre une protection inverse.

L'alimentation FV de l'adaptateur réseau est normale.

Le fait de ne pas suivre les instructions peut entraîner une défaillance de la protection fournie par l'équipement, ce qui peut entraîner des conséquences graves, comme des blessures ou des dommages à l'équipement.

3.3 External terminal block

Module number	MTC034	MTE034
Name	Scre terminal block	Spring terminal block
Suitable cable	DX210-3SFX-2000	
Nominal current	1A	
Nominal voltage	DC24V	
Wiring	Max. AWG 18	

MTE034

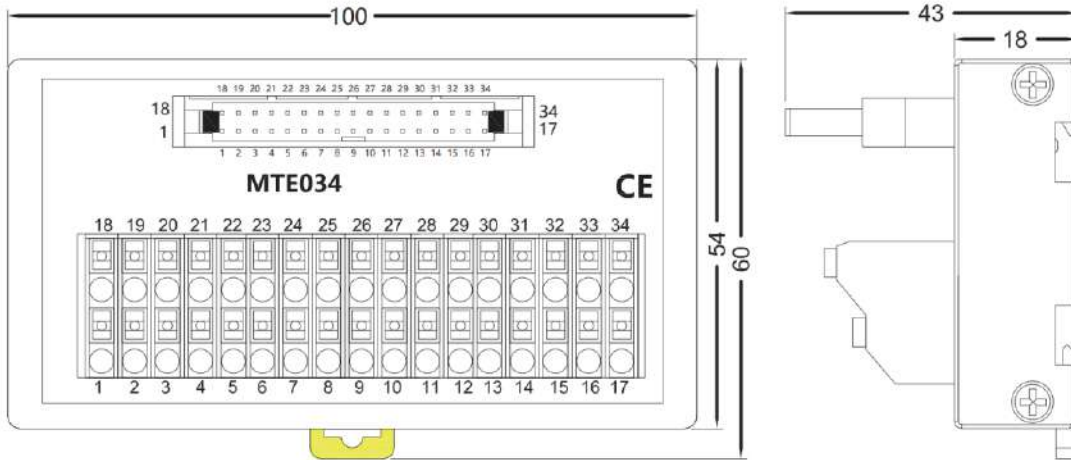

MTC034

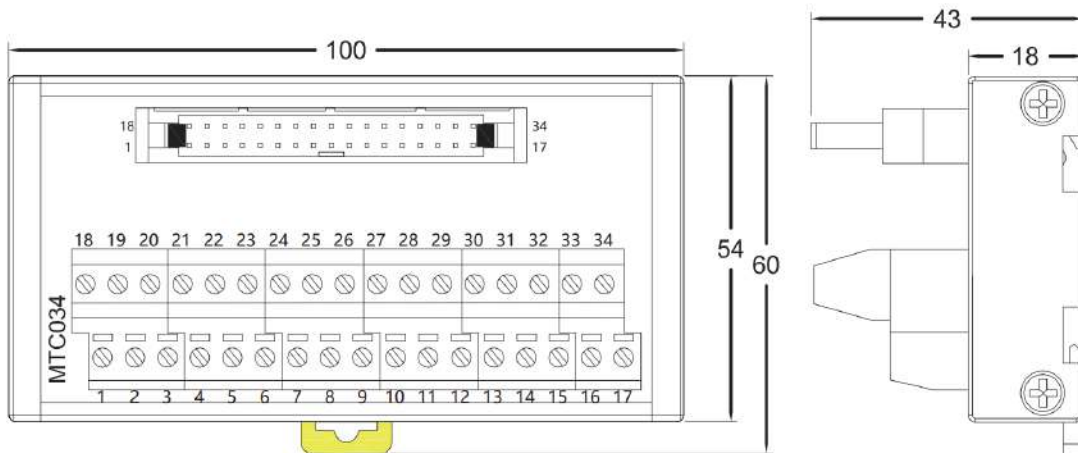

4 Wiring

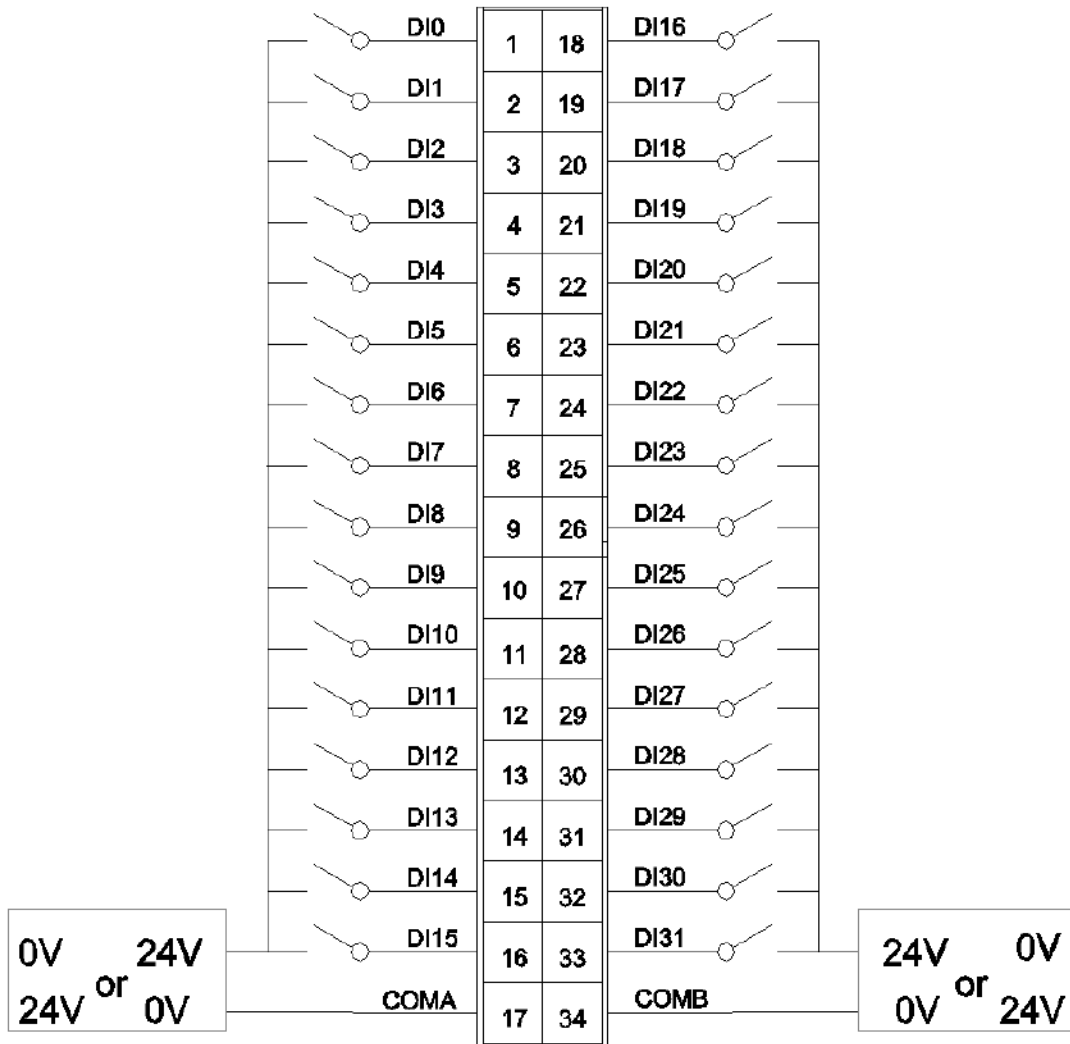

5 Process data definition

<32DI Input Status> Submodule process data definition

Input data								
Bit No	Bit 7	Bit 6	Bit 5	Bit 4	Bit 3	Bit 2	Bit 1	Bit 0
Byte 0	DI Ch#7	DI Ch#6	DI Ch#5	DI Ch#4	DI Ch#3	DI Ch#2	DI Ch#1	DI Ch#0
Byte 1	DI Ch#15	DI Ch#14	DI Ch#13	DI Ch#12	DI Ch#11	DI Ch#10	DI Ch#9	DI Ch#8
Byte 2	DI Ch#23	DI Ch#22	DI Ch#21	DI Ch#20	DI Ch#19	DI Ch#18	DI Ch#17	DI Ch#16
Byte 3	DI Ch#31	DI Ch#30	DI Ch#29	DI Ch#28	DI Ch#27	DI Ch#26	DI Ch#25	DI Ch#24

Data description:

DI Ch#(0-31): When the corresponding channel input signal is valid, the bit is 1, and when the input is invalid, it is 0.

0: Input signal invalid

1: Input signal valid

<16DI Counter Submodule> Submodule process data definition

Input data								
Bit No	Bit 7	Bit 6	Bit 5	Bit 4	Bit 3	Bit 2	Bit 1	Bit 0
Byte 0	Counter Value Ch#0							
Byte 1								
Byte 2								
Byte 3								
Byte 4	Counter Value Ch#1							
Byte 5								
Byte 6								
Byte 7								
Byte 8	Counter Value Ch#2							
Byte 9								
Byte 10								
Byte 11								
Byte 12	Counter Value Ch#3							
Byte 13								
Byte 14								
Byte 15								
Byte 16	Counter Value Ch#4							
Byte 17								

Byte 18								
Byte 19								
Byte 20								
Byte 21	Counter Value Ch#5							
Byte 22								
Byte 23								
Byte 24								
Byte 25	Counter Value Ch#6							
Byte 26								
Byte 27								
Byte 28								
Byte 29	Counter Value Ch#7							
Byte 30								
Byte 31								
...								
...	...							
...								
...								
...								
...	...							
...								
...								
...								
Byte 116	Counter Value Ch#29							
Byte 117								
Byte 118								
Byte 119								
Byte 120	Counter Value Ch#30							
Byte 121								
Byte 122								
Byte 123								
Byte 124	Counter Value Ch#31							
Byte 125								
Byte 126								
Byte 127								
Output data								
Bit No	Bit 7	Bit 6	Bit 5	Bit 4	Bit 3	Bit 2	Bit 1	Bit 0
Byte 0	Counter Reset Ch#7	Counter Reset Ch#6	Counter Reset Ch#5	Counter Reset Ch#4	Counter Reset Ch#3	Counter Reset Ch#2	Counter Reset Ch#1	Counter Reset Ch#0
Byte 1	Counter Reset Ch#15	Counter Reset Ch#14	Counter Reset Ch#13	Counter Reset Ch#12	Counter Reset Ch#11	Counter Reset Ch#10	Counter Reset Ch#9	Counter Reset Ch#8
Byte 2	Counter Reset Ch#23	Counter Reset Ch#22	Counter Reset Ch#21	Counter Reset Ch#20	Counter Reset Ch#19	Counter Reset Ch#18	Counter Reset Ch#17	Counter Reset Ch#16

Byte 3	Counter Reset Ch#31	Counter Reset Ch#30	Counter Reset Ch#29	Counter Reset Ch#28	Counter Reset Ch#27	Counter Reset Ch#26	Counter Reset Ch#25	Counter Reset Ch#24
--------	---------------------------	---------------------------	---------------------------	---------------------------	---------------------------	---------------------------	---------------------------	---------------------------

Data description:

Counter Value Ch#(0-31): Count value, 32-bit unsigned integer, automatically zeroing after overflow.

Counter Reset Ch#(0-31): When the data bit changes from 0 to 1 (rising edge), the input counter of the corresponding channel is cleared.

Note: the maximum counting frequency of the input channel is 200Hz. When the input signal exceeds this frequency, the counting result may be inconsistent with the actual value.

6 Configuration parameter definitions

Configuration parameters								
Bit No	Bit 7	Bit 6	Bit 5	Bit 4	Bit 3	Bit 2	Bit 1	Bit 0
Byte 0	Input Filtering Time(ms)							
Byte 1								
Byte 2	Reserved				Input Holding Time(ms)			

Data description:

Input Filtering Time(ms): Input filter time of Channel (ms) (Default: 10)

Input Holding Time(ms): Signal input holding time of Channel (ms) (Default:0)

- 0: Disable
- 1: 200ms
- 2: 500ms
- 3: 1000ms
- 4: 1500ms
- 5: 2000ms
- 6: 3000ms
- 7: 5000ms

<32DI Counter Submodule>Submodule configuration parameter definition

Configuration parameters									
Bit No	Bit 7	Bit 6	Bit 5	Bit 4	Bit 3	Bit 2	Bit 1	Bit 0	
Byte 0	Reserved				Storage Enable	Storage Function	32Bit Data Format		
Byte 1	Count Mode Ch#3		Count Mode Ch#2		Count Mode Ch#1		Count Mode Ch#0		
Byte 2	Count Mode Ch#7		Count Mode Ch#6		Count Mode Ch#5		Count Mode Ch#4		
Byte 3	Count Mode Ch#11		Count Mode Ch#10		Count Mode Ch#9		Count Mode Ch#8		
Byte 4	Count Mode Ch#15		Count Mode Ch#14		Count Mode Ch#13		Count Mode Ch#12		
Byte 5	Count Mode Ch#19		Count Mode Ch#18		Count Mode Ch#17		Count Mode Ch#16		
Byte 6	Count Mode Ch#23		Count Mode Ch#22		Count Mode Ch#21		Count Mode Ch#20		
Byte 7	Count Mode Ch#27		Count Mode Ch#26		Count Mode Ch#25		Count Mode Ch#24		
Byte 8	Count Mode		Count Mode		Count Mode		Count Mode		

	Ch#31		Ch#30		Ch#29		Ch#28	
Byte 9	Count Direction Ch#7	Count Direction Ch#6	Count Direction Ch#5	Count Direction Ch#4	Count Direction Ch#3	Count Direction Ch#2	Count Direction Ch#1	Count Direction Ch#0
Byte 10	Count Direction Ch#15	Count Direction Ch#14	Count Direction Ch#13	Count Direction Ch#12	Count Direction Ch#11	Count Direction Ch#10	Count Direction Ch#9	Count Direction Ch#8
Byte 11	Count Direction Ch#23	Count Direction Ch#22	Count Direction Ch#21	Count Direction Ch#20	Count Direction Ch#19	Count Direction Ch#18	Count Direction Ch#17	Count Direction Ch#16
Byte 12	Count Direction Ch#31	Count Direction Ch#30	Count Direction Ch#29	Count Direction Ch#28	Count Direction Ch#27	Count Direction Ch#26	Count Direction Ch#25	Count Direction Ch#24

Data description:

32Bit Data Format: Byte transfer order of Channel count value (Default: 0)

- 0: AB-CD
- 1: BA-DC
- 2: CD-AB
- 3: DC-BA

Storage Function: Storage Function is supported or not, read only, and this value is the actual value of the module when uploading device parameters.

- 0: storage is not supported
- 1: storage is supported

Storage Enable: Storage enable, when the Storage Function enables, the IO module will save the count value in real time to non-volatile memory, and load the last saved count value on the next power on. (Default: 1)

- 0: Disabled
- 1: Enable

Count Mode Ch# (0-31): Count mode of the input channel. (Default: 0)

- 0: rising edge count
- 1: falling edge count
- 2: double edge count

Count Direction Ch# (0-31): The counting direction of the input channel. (Default: 0)

- 0: count up

1: count down

A Dimension drawing

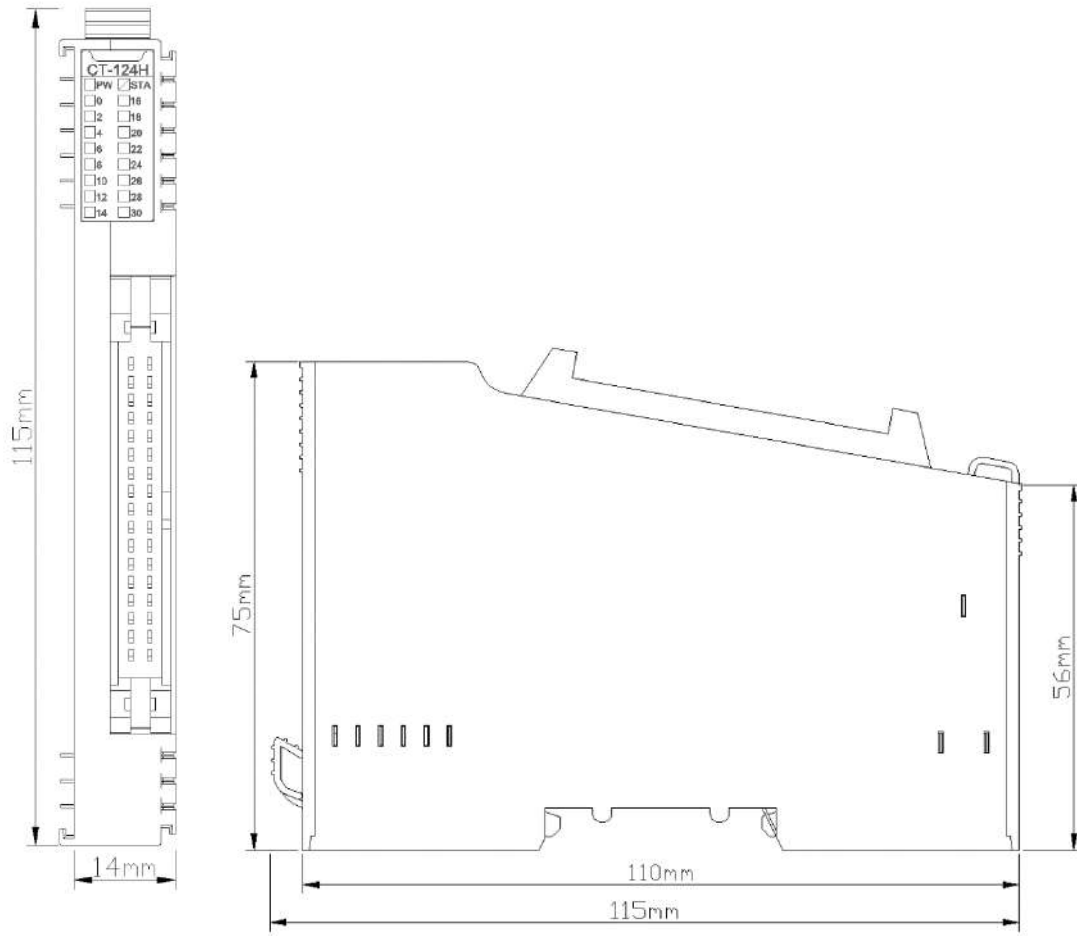

CT-124D 32-channel digital input/24VDC/Sink or Source

1 Module features

- ◆ The module supports 32 channels of digital input, supports high-level input, and could be connected to PNP sensor, and supports low-level input, and could be connected to NPN sensor.
- ◆ The module can collect the digital output signal (dry contact or active output) of the field device.
- ◆ The module can be connected to 2-wire or 3-wire digital sensor.
- ◆ The internal bus and field input of the module are isolated by optocoupler.
- ◆ The module supports the input signal holding function, and the holding time can be set.
- ◆ After adding the counting submodule, the counting function is available.
- ◆ Each input channel of the module supports 32-bit counter, and the counting frequency < 200Hz.
- ◆ The module can set the digital signal input filtering time and counter byte transmission sequence.
- ◆ The module can independently set the counting mode and counting direction for each channel.

2 Technical Parameters

General Parameters	
Power	Max.95mA@5.0VDC
Isolation	Isolation voltage between the channel and system power supply: AC 500V Isolation voltage between channel and field power supply: AC 500V Isolation voltage between the channel and PE: AC 500V
Wiring	Max.: AWG 18 Min.: AWG 24
Installation Mode	35mm DIN-Rail
Size	115*27*75mm
Weight	110g
Vibration Resistance	Comply with IEC 61131-2 and IEC 60068-2-6
Impact resistance	Comply with IEC 61131-2 and IEC 60068-2-27
EMC Performance	Comply with IEC 61131-2 and IEC 61000-4
Environmental Parameters	
Operating Temperature of Horizontal Installation	-35°C~70°C
Operating Temperature of Vertical Installation	-35°C~60°C
Relative Humidity	< 95%RH (No Condensation)
Storage Temperature	-40°C~85°C
Storage Humidity	< 95%RH (No Condensation)
Manufacturing Test Temperature	-40°C~75°C
Ingress Protection Rating	IP20
Input Parameters	
Channel Number	32 channels
LED Indicator	32 panel LED indicators and 32 channel LED indicators, all this are green
Input Type	PNP/NPN
Input Standard	The input conforms to IEC 61131-2 Type3
Opening Voltage	Min.11VDC to Max.30VDC
Turn-off Voltage	Max.5VDC
Opening Current	6.5mA@24V
Input impedance	3.7kΩ
Input Delay	OFF to ON: Max.3ms ON to OFF: Max.2ms
Filtering Time	Default 10ms

Counting Frequency	500Hz
Opening Voltage	200Hz (Duty cycle 50%, filtering time 0ms)
Effective pulse width for counting	2.5ms

! WARNING

UNEXPECTED EQUIPMENT OPERATION

Do not exceed any of the ratings specified in the environmental and electrical characteristics table.

Failure to follow instructions specified by the manufacturer may result in serious consequences such as death, personal injury, or damage to equipment since the protection provided by the equipment may be impaired.

! AVERTISSEMENT

FONCTIONNEMENT INATTENDU DE L'EQUIPEMENT

Ne dépassez aucune évaluation spécifiée dans le tableau de caractéristiques environnementales et électriques..

Le fait de ne pas suivre les instructions peut entraîner une défaillance de la protection fournie par l'équipement, ce qui peut entraîner des conséquences graves, comme des blessures ou des dommages à l'équipement.

3 Hardware interface

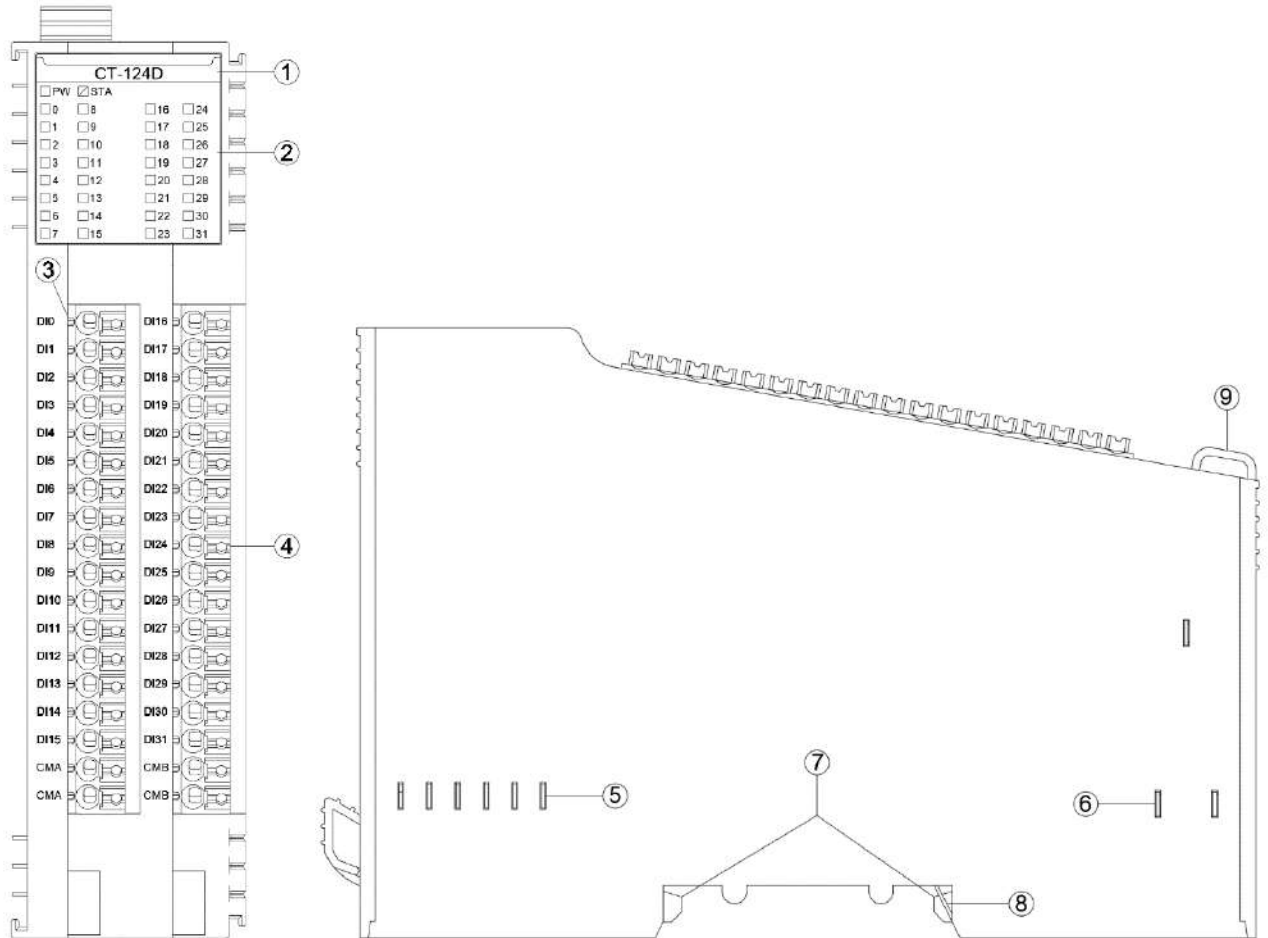

- ① Module Type
- ② State indicator
- ③ Channel indicator
- ④ Wiring Terminal and identification
- ⑤ Internal Bus
- ⑥ Field Power
- ⑦ Buckle
- ⑧ Grounding Spring Sheet
- ⑨ Fixed Wiring Harness

3.1 LED Indicator Definition

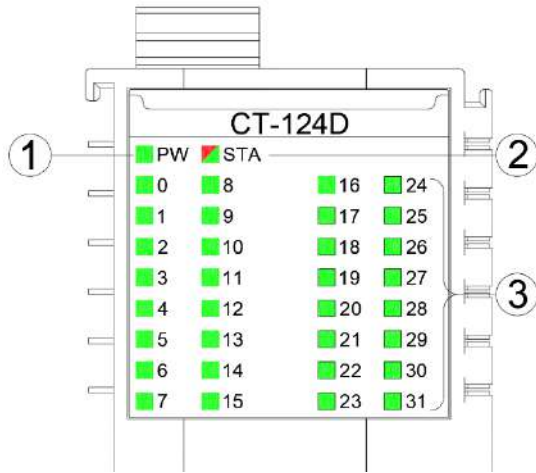

- ① Power indicator (green)
- ② Module status indicator (red/green)
- ③ Input channel indicator (green)

PW Power State (GREEN)	Definition
ON	The internal bus power supply is normal
OFF	The internal bus power supply is abnormal
STA Module State (RED/GREEN)	Definition
Green Slow Flashing (2.5Hz)	The module's internal bus is not started
Red Slow Flashing (2.5Hz)	The internal bus of the module is offline
On(GREEN)	Operation normal
Flash(2.5Hz) (RED/GREEN)	Upgrading mode
Flash(10Hz) (RED/GREEN)	Firmware upgrading
Double Flash (RED)	Module exception has been soft-restarted
0-31 Channel Indicator (GREEN)	Definition
ON	The input signal is valid
OFF	The input signal is invalid

WARNING

UNEXPECTED EQUIPMENT OPERATION

By viewing the PW indicator, could determine the power supply status of a module. If the PW is steady green, the power supply is normal. Otherwise, the module cannot work properly.

When the module is initially powered on, there will be 3S for the backplane bus connection. After the backplane bus is initialized, STA is in the green steady state. If STA is in the green blinking state, it indicates that the backplane bus has not been initialized, and it needs to be powered off and restarted for re-initialization.

STA abnormal working state occurs during the normal operation of the module, please check the firmware version information of all modules, and consult ODOT technical support for details.

If a module is upgraded, check that all modules are in the normal state after the upgrade. Otherwise, an exception may occur.

Failure to follow instructions specified by the manufacturer may result in serious consequences such as death, personal injury, or damage to equipment since the protection provided by the equipment may be impaired.

AVERTISSEMENT

FONCTIONNEMENT INATTENDU DE L'EQUIPEMENT

En regardant l'état de l'indicateur de PW, jugez l'état d'alimentation du module. Le feu vert PW reste allumé et l'alimentation est normale. Autrement, le module ne fonctionnera pas correctement.

Lorsque le module est alimenté initialement, il y aura 3S pour la connexion de bus de backboard. STA est un état vert permanent après l'initialisation du bus de backboard. Si STA est en état de clignotement vert, cela signifie que l'initialisation du bus de backboard n'est pas passée et doit être redémarrée hors tension et réinitialisée.

L'état de fonctionnement anormal de STA se produit pendant le fonctionnement normal du module, veuillez vérifier les informations de version du firmware de tous les modules, et consulter le support technique ODOT pour plus de détails.

Si le module a une opération de mise à niveau, après l'achèvement de la mise à niveau, le besoin de vérifier que tous les modules sont dans l'état normal avant de courir, sinon il conduira à une exception.

Le fait de ne pas suivre les instructions peut entraîner une défaillance de la protection fournie par l'équipement, ce qui peut entraîner des conséquences graves, comme des blessures ou des dommages à l'équipement.

3.2 Terminal Definition

Instructions	Symbol	Terminal serial number	Terminal serial number	Symbol	Instructions
Signal input	DI0	1	19	DI16	Signal input
	DI1	2	20	DI17	
	DI2	3	21	DI18	
	DI3	4	22	DI19	
	DI4	5	23	DI20	
	DI5	6	24	DI21	
	DI6	7	25	DI22	
	DI7	8	26	DI23	
	DI8	9	27	DI24	
	DI9	10	28	DI25	
	DI10	11	29	DI26	
	DI11	12	30	DI27	
	DI12	13	31	DI28	
	DI13	14	32	DI29	
	DI14	15	33	DI30	
DI15	16	34	DI31		
0V or 24V	CMA	17	35	CMB	0V or 24V
0V or 24V	CMA	18	36	CMB	0V or 24V

When connecting a cold-pressed terminal, the terminal must be terminated and checked in strict accordance with the corresponding termination specifications or requirements, and connect the cold-pressed terminal according to the corresponding node serial number. The conductor should use copper conductor and the conductor core should be larger than 0.2mm² and smaller than 1mm² (AWG18~AWG24). Cold-pressed terminal parameters are as follows:



! WARNING

UNEXPECTED EQUIPMENT OPERATION

Strip the length of the conductor insulation layer is greater than 10mm to ensure reliable signal connection.

The wire needs to use copper wire and the wire core is greater than or equal to 0.2mm² and less than or equal to 1mm² to ensure reliable signal connection.

When connecting a cold-press terminal, connect the cold-press terminal strictly in accordance with the corresponding termination specifications or requirements, and connect the cold-press terminal according to the corresponding node serial number.

Do not power on cold-press terminals until they are properly connected or fully locked.

Failure to follow instructions specified by the manufacturer may result in serious consequences such as death, personal injury, or damage to equipment since the protection provided by the equipment may be impaired.

! AVERTISSEMENT

FONCTIONNEMENT INATTENDU DE L'EQUIPEMENT

Dépouillez la longueur de la couche isolante du fil plus de 10mm pour assurer la connexion fiable du signal.

Le conducteur doit utiliser le fil de cuivre et le noyau de fil est supérieur ou égal à 0,2 mm², inférieur ou égal à 1mm², afin d'assurer la connexion fiable du signal.

Lorsque les terminaux de presse à froid sont terminés, ils doivent être terminés et visualisés en stricte conformité avec les spécifications ou les exigences correspondantes et terminés selon le numéro de série de noeud correspondant.

Il est interdit d'activer les bornes à froid avant qu'elles ne soient correctement articulées ou complètement verrouillées.

Le fait de ne pas suivre les instructions peut entraîner une défaillance de la protection fournie par l'équipement, ce qui peut entraîner des conséquences graves, comme des blessures ou des dommages à l'équipement.

! DANGER

FIRE DANGER

Use the correct wiring rules only for the maximum current capacity of the I/O channel and power supply.

Failure to follow instructions specified by the manufacturer may result in serious consequences such as death, personal injury, or damage to equipment since the protection provided by the equipment may be impaired.

! WARNING

UNEXPECTED EQUIPMENT OPERATION

Do not exceed any of the ratings specified in the environmental and electrical characteristics table.

Failure to follow instructions specified by the manufacturer may result in serious consequences such as death, personal injury, or damage to equipment since the protection provided by the equipment may be impaired.

 AVERTISSEMENT

FONCTIONNEMENT INATTENDU DE L'EQUIPEMENT

Ne dépassez aucune évaluation spécifiée dans le tableau de caractéristiques environnementales et électriques..

Le fait de ne pas suivre les instructions peut entraîner une défaillance de la protection fournie par l'équipement, ce qui peut entraîner des conséquences graves, comme des blessures ou des dommages à l'équipement.

4 Wiring

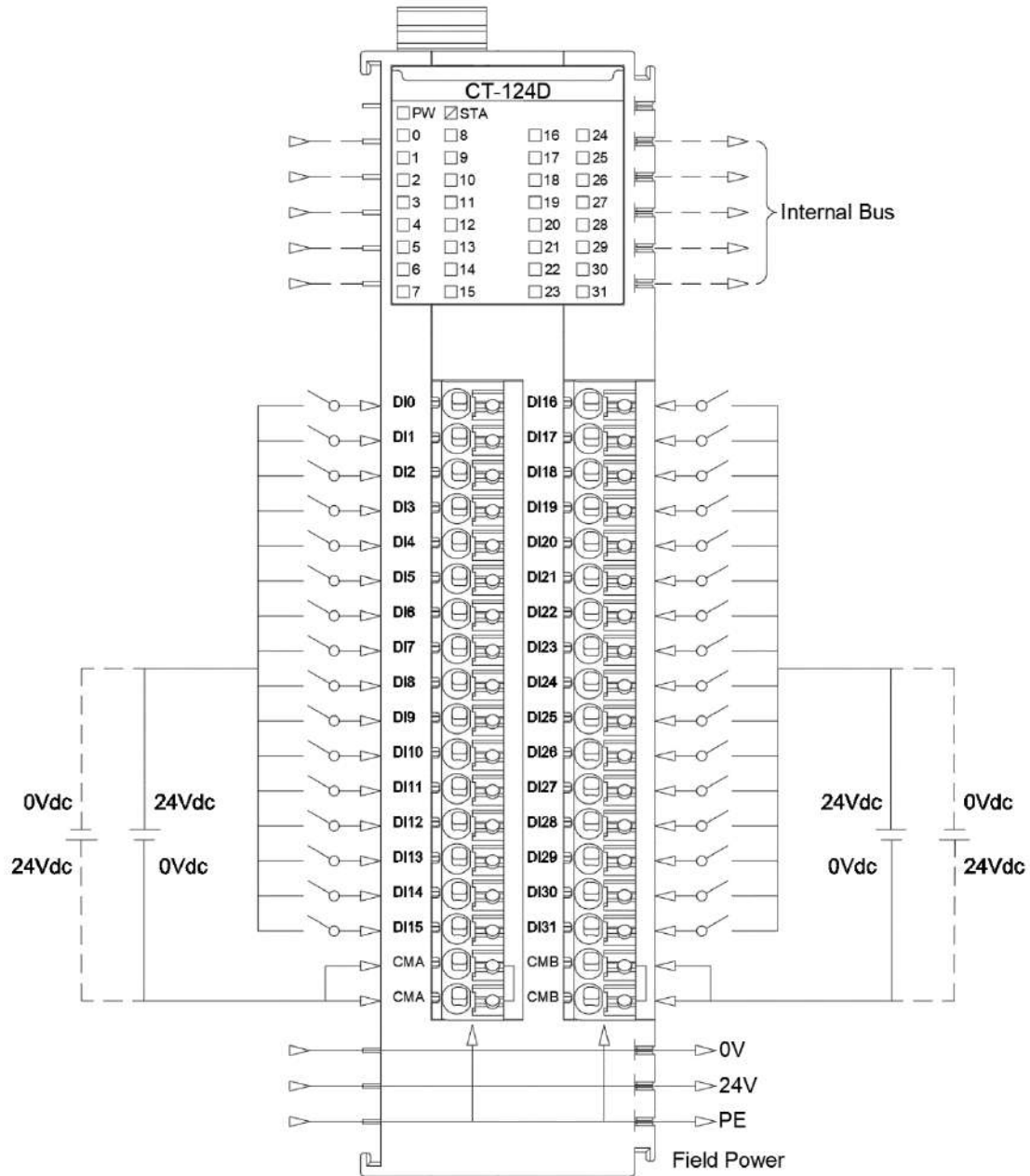

NOTICE

EQUIPMENT INOPERABLE

Do not crimp the spring terminal with more than the maximum pressure specified for the terminal. Otherwise, the resilience of the spring terminal may be damaged and the terminal rebound may be affected.

Do not press the spring terminal with a sharp tool when removing cable from the channel. Otherwise, the spring terminal will be damaged.

Failure to follow these instructions may result in equipment damage.

5 Process Data Definition

<32DI Input Status > submodule process data definition

Input data								
Bit No	Bit 7	Bit 6	Bit 5	Bit 4	Bit 3	Bit 2	Bit 1	Bit 0
Byte 0	DI Ch#7	DI Ch#6	DI Ch#5	DI Ch#4	DI Ch#3	DI Ch#2	DI Ch#1	DI Ch#0
Byte 1	DI Ch#15	DI Ch#14	DI Ch#13	DI Ch#12	DI Ch#11	DI Ch#10	DI Ch#9	DI Ch#8
Byte 2	DI Ch#23	DI Ch#22	DI Ch#21	DI Ch#20	DI Ch#19	DI Ch#18	DI Ch#17	DI Ch#16
Byte 3	DI Ch#31	DI Ch#30	DI Ch#29	DI Ch#28	DI Ch#27	DI Ch#26	DI Ch#25	DI Ch#24

Data Description:

DI Ch# (0-31): When the input signal of the corresponding channel is valid, the bit is forced to 1, and when the input is invalid, it is 0

0: The input signal is invalid

1: The input signal is valid

<16DI Counter Submodule > Counting Submodule Process Data Definitions

Input data								
Bit No	Bit 7	Bit 6	Bit 5	Bit 4	Bit 3	Bit 2	Bit 1	Bit 0
Byte 0	Counter Value Ch#0							
Byte 1								
Byte 2								
Byte 3								
Byte 4	Counter Value Ch#1							
Byte 5								
Byte 6								
Byte 7								
Byte 8	Counter Value Ch#2							
Byte 9								
Byte 10								
Byte 11								
Byte 12	Counter Value Ch#3							
Byte 13								
Byte 14								
Byte 15								
Byte 16	Counter Value Ch#4							
Byte 17								
Byte 18								
Byte 19								

Byte 20	Counter Value Ch#5							
Byte 21								
Byte 22								
Byte 23								
Byte 24	Counter Value Ch#6							
Byte 25								
Byte 26								
Byte 27								
Byte 28	Counter Value Ch#7							
Byte 29								
Byte 30								
Byte 31								
...	...							
...								
...								
...								
...	...							
...								
...								
...								
Byte 116	Counter Value Ch#29							
Byte 117								
Byte 118								
Byte 119								
Byte 120	Counter Value Ch#30							
Byte 121								
Byte 122								
Byte 123								
Byte 124	Counter Value Ch#31							
Byte 125								
Byte 126								
Byte 127								
Output data								
Bit No	Bit 7	Bit 6	Bit 5	Bit 4	Bit 3	Bit 2	Bit 1	Bit 0
Byte 0	Counter Reset Ch#7	Counter Reset Ch#6	Counter Reset Ch#5	Counter Reset Ch#4	Counter Reset Ch#3	Counter Reset Ch#2	Counter Reset Ch#1	Counter Reset Ch#0
Byte 1	Counter Reset Ch#15	Counter Reset Ch#14	Counter Reset Ch#13	Counter Reset Ch#12	Counter Reset Ch#11	Counter Reset Ch#10	Counter Reset Ch#9	Counter Reset Ch#8
Byte 2	Counter Reset Ch#23	Counter Reset Ch#22	Counter Reset Ch#21	Counter Reset Ch#20	Counter Reset Ch#19	Counter Reset Ch#18	Counter Reset Ch#17	Counter Reset Ch#16
Byte 3	Counter Reset Ch#31	Counter Reset Ch#30	Counter Reset Ch#29	Counter Reset Ch#28	Counter Reset Ch#27	Counter Reset Ch#26	Counter Reset Ch#25	Counter Reset Ch#24

Data Description:

Counter Value Ch#(0-31): Count value, 32-bit unsigned integer, automatically zeroing after overflow.

Counter Reset Ch#(0-31): When the data bit changes from 0 to 1 (rising edge), the input counter of the corresponding channel is zeroed.

Note: The maximum frequency of the input channel is 200Hz, when the input signal exceeds this frequency, the counting result may be inconsistent with the actual value.

6 Configuration Parameter Definition

Configure parameters								
Bit No	Bit 7	Bit 6	Bit 5	Bit 4	Bit 3	Bit 2	Bit 1	Bit 0
Byte 0	Input Filtering Time(ms)							
Byte 1								
Byte 2	Reserved				Input Holding Time(ms)			

Data Description:

Input Filtering Time (ms): Input filtering time of channel(ms) (Default: 10).

Input Holding Time (ms): Signal input holding time of channel(ms)(Default: 0).

- 0: Disable
- 1: 200ms
- 2: 500ms
- 3: 1000ms
- 4: 1500ms
- 5: 2000ms
- 6: 3000ms
- 7: 5000ms

< 32DI Counter Submodule > Submodule configuration parameter definition

Configure parameters									
Bit No	Bit 7	Bit 6	Bit 5	Bit 4	Bit 3	Bit 2	Bit 1	Bit 0	
Byte 0	Reserved				Storage Enable	Storage Function	32Bit Data Format		
Byte 1	Count Mode Ch#3		Count Mode Ch#2		Count Mode Ch#1		Count Mode Ch#0		
Byte 2	Count Mode Ch#7		Count Mode Ch#6		Count Mode Ch#5		Count Mode Ch#4		
Byte 3	Count Mode Ch#11		Count Mode Ch#10		Count Mode Ch#9		Count Mode Ch#8		
Byte 4	Count Mode Ch#15		Count Mode Ch#14		Count Mode Ch#13		Count Mode Ch#12		
Byte 5	Count Mode Ch#19		Count Mode Ch#18		Count Mode Ch#17		Count Mode Ch#16		
Byte 6	Count Mode Ch#23		Count Mode Ch#22		Count Mode Ch#21		Count Mode Ch#20		
Byte 7	Count Mode Ch#27		Count Mode Ch#26		Count Mode Ch#25		Count Mode Ch#24		

Byte 8	Count Mode Ch#31		Count Mode Ch#30		Count Mode Ch#29		Count Mode Ch#28	
Byte 9	Count Direction Ch#7	Count Direction Ch#6	Count Direction Ch#5	Count Direction Ch#4	Count Direction Ch#3	Count Direction Ch#2	Count Direction Ch#1	Count Direction Ch#0
Byte 10	Count Direction Ch#15	Count Direction Ch#14	Count Direction Ch#13	Count Direction Ch#12	Count Direction Ch#11	Count Direction Ch#10	Count Direction Ch#9	Count Direction Ch#8
Byte 11	Count Direction Ch#23	Count Direction Ch#22	Count Direction Ch#21	Count Direction Ch#20	Count Direction Ch#19	Count Direction Ch#18	Count Direction Ch#17	Count Direction Ch#16
Byte 12	Count Direction Ch#31	Count Direction Ch#30	Count Direction Ch#29	Count Direction Ch#28	Count Direction Ch#27	Count Direction Ch#26	Count Direction Ch#25	Count Direction Ch#24

Data description:

32Bit Data Format: Byte transmission sequence of Channel count value (Default: 0)

0: AB-CD

1: BA-DC

2: CD-AB

3: DC-BA

Storage Function: Storage Function is supported or not, read only, and this value is the actual value of the module when uploading device parameters.

0: storage is not supported

1: storage is supported

Storage Enable: Storage enable, when the Storage Function enables, the IO module will save the count value in real time to non-volatile memory, and load the last saved count value on the next power on. (Default: 1)

0: Disabled

1: Enable

Count Mode Ch# (0-31): Count mode of the input channel. (Default: 0)

0: Rising edge count

1: Falling edge count

2: Bilateral edge counting

Count Direction Ch# (0-31): The counting direction of the input channel. (Default: 0)

0: count up

1: count down

A Dimensional drawing

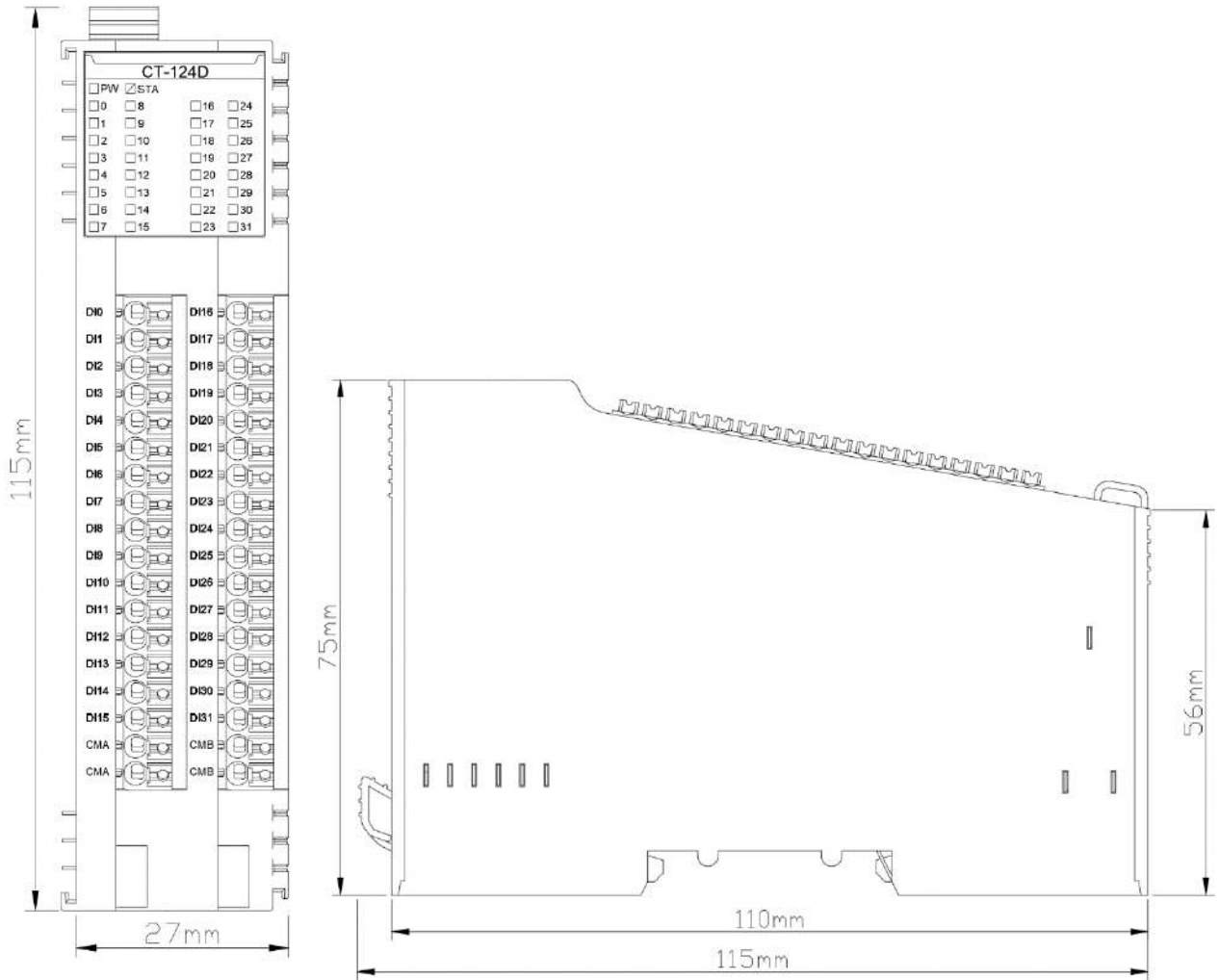

CT-125F 16 channels digital input/24VDC/ PNP

1 Module features

- ◆ The module supports 16 channels digital input, supports sink input, and the input voltage is 24VDC and the input high level is valid. It could support PNP sensor.
- ◆ The module could collect digital output signal of field equipment (dry contact or active output).
- ◆ The module could be accessed to 2-wire or 3-wire digital sensor.
- ◆ The internal bus and field input of the module is isolated.
- ◆ The module supports the input signal holding function, and the holding time can be set.
- ◆ The module carries 16 digital input channels with LED indicator on each channel.
- ◆ Supports counting function after adding counting sub-module.
- ◆ The field power detection function is effective after the onsite power detection submodule is added
- ◆ Each input channel of the module supports a 32-bit counter with the counting frequency <200Hz.
- ◆ The module could be set the digital signal input filtering time and the byte transmission order of the counter.
- ◆ Each channel of the module could be set the counting mode and counting direction independently.
- ◆ The module input channel loop power supply requires 24VDC external power supply.

2 Technical parameters

General Parameters	
Power Consumption	Max.70mA@5.0VDC
Isolation	The isolation voltage between the I/O channel and the system power supply: AC500V The isolation voltage between the I/O channel and the field power supply: AC500V Isolation voltage between the I/O channel and PE: AC 500V
Field Power	Nominal:24VDC, Range:20.4-28.8VDC
Wiring	Max.: AWG 18 Min.: AWG 24
Installation	35mm DIN-Rail
Size	115*14*75mm
Weight	65g
Environment Specification	
Operating Temperature of Horizontal Installation	-35°C~70°C
Operating Temperature of Vertical Installation	-35°C~60°C
Relative Humidity	< 95%RH (No Condensation)
Storage Temperature	-40°C~85°C
Storage Humidity	< 95%RH (No Condensation)
Manufacturing Test Temperature	-40°C~75°C
Ingress Protection Rating	IP20
Input Parameters	
Channel Number	16 channel sink input
LED Indicator	16 channel input LED indicator
Input type	IEC 61131-2 Tyepe3
Turn-on Voltage	Min. 11VDC to Max. 30VDC (Relative to 0V terminal)
Turn-off Voltage	Min. -3VDC to Max. 30VDC (Relative to 0V terminal)
Turn-on Current	11VDC 3.953mA
Input impedance	>2.5kΩ
Input Delay	OFF to ON: Max. 1.097ms ON to OFF: Max. 0.781ms
Filter Time	Default 10ms
Sample Frequency	500Hz
Counter Frequency	<200Hz
Effective pulse width for counting	2.5ms
EMC parameters	
Static Electricity	Air 8KV/ Contact 4KV

EFT	2KV
Surge	2KV

! WARNING

UNEXPECTED EQUIPMENT OPERATION

Do not exceed any of the ratings specified in the environmental and electrical characteristics table.

Failure to follow instructions specified by the manufacturer may result in serious consequences such as death, personal injury, or damage to equipment since the protection provided by the equipment may be impaired.

! AVERTISSEMENT

FONCTIONNEMENT INATTENDU DE L'EQUIPEMENT

Ne dépassez aucune évaluation spécifiée dans le tableau de caractéristiques environnementales et électriques..

Le fait de ne pas suivre les instructions peut entraîner une défaillance de la protection fournie par l'équipement, ce qui peut entraîner des conséquences graves, comme des blessures ou des dommages à l'équipement.

3 Hardware interfaces

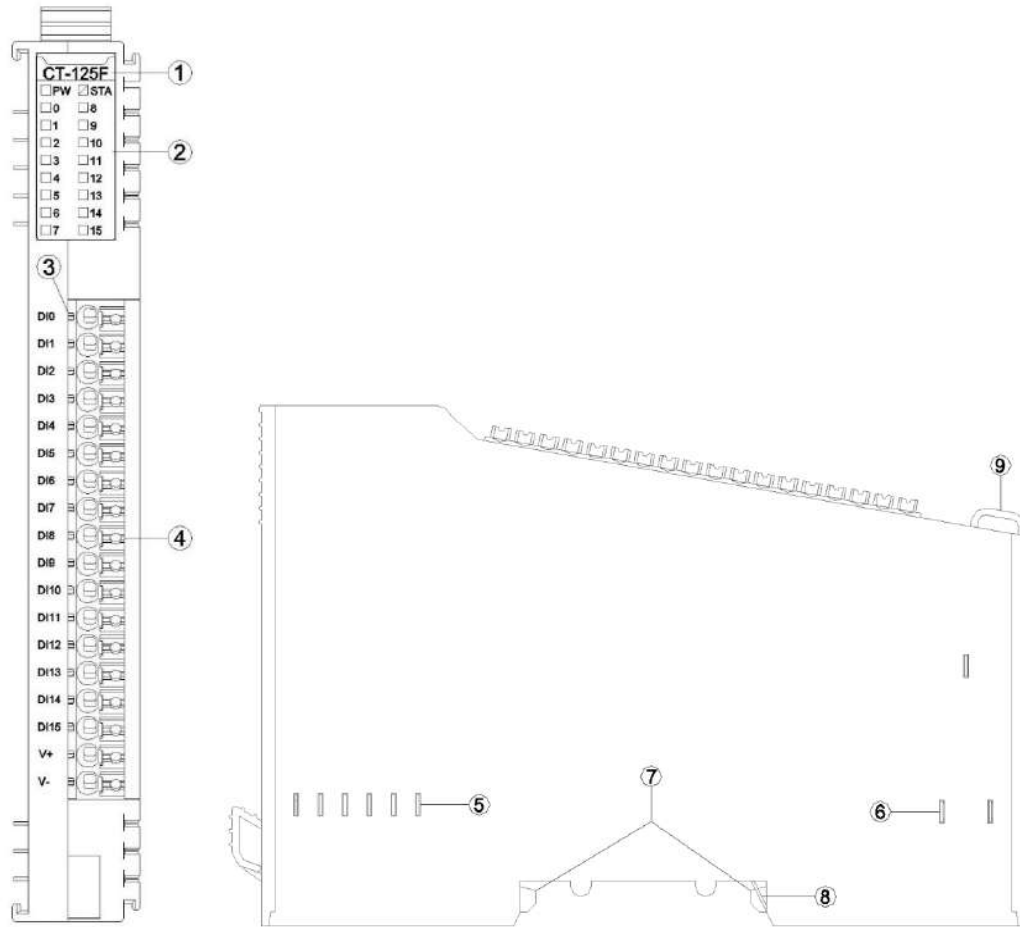

- ① Module Type
- ② State indicator
- ③ Channel indicator
- ④ Wiring Terminal and identification
- ⑤ Internal Bus
- ⑥ Field Power
- ⑦ Buckle
- ⑧ Grounding Spring Sheet
- ⑨ Fixed Wiring Harness

3.1 LED indicator definition

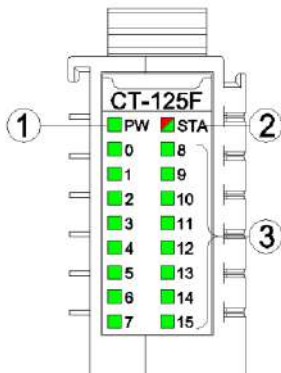

- ① Power LED indicator (green)
- ② Module State LED indicator (red/green)
- ③ Input channel LED indicator (green)

PW Power State (GREEN)	Definition
ON	Internal bus Power Normal
OFF	Internal bus Power Failure
STA Module State (RED/GREEN)	Definition
Green slow flash (2.5Hz)	Module internal bus is not started
Red slow flash (2.5Hz)	Module internal bus offline
ON (GREEN)	Operation normal
Flash(2.5Hz) (RED/GREEN)	Upgrading mode
Flash(10Hz) (RED/GREEN)	Firmware Update
Double Flash (RED)	Module Exception has been soft-restarted
0-15 channel indicator light	Definition
ON	Input signal valid
OFF	Input signal invalid

⚠ WARNING

UNEXPECTED EQUIPMENT OPERATION

By viewing the PW indicator, could determine the power supply status of a module. If the PW is steady green, the power supply is normal. Otherwise, the module cannot work properly.

When the module is initially powered on, there will be 3S for the backplane bus connection. After the backplane bus is initialized, STA is in the green steady state. If

STA is in the green blinking state, it indicates that the backplane bus has not been initialized, and it needs to be powered off and restarted for re-initialization.

STA abnormal working state occurs during the normal operation of the module, please check the firmware version information of all modules, and consult ODOT technical support for details.

If a module is upgraded, check that all modules are in the normal state after the upgrade. Otherwise, an exception may occur.

Failure to follow instructions specified by the manufacturer may result in serious consequences such as death, personal injury, or damage to equipment since the protection provided by the equipment may be impaired.

AVERTISSEMENT

FONCTIONNEMENT INATTENDU DE L'EQUIPEMENT

En regardant l'état de l'indicateur de PW, jugez l'état d'alimentation du module. Le feu vert PW reste allumé et l'alimentation est normale. Autrement, le module ne fonctionnera pas correctement.

Lorsque le module est alimenté initialement, il y aura 3S pour la connexion de bus de backboard. STA est un état vert permanent après l'initialisation du bus de backboard. Si STA est en état de clignotement vert, cela signifie que l'initialisation du bus de backboard n'est pas passée et doit être redémarrée hors tension et réinitialisée.

L'état de fonctionnement anormal de STA se produit pendant le fonctionnement normal du module, veuillez vérifier les informations de version du firmware de tous les modules, et consulter le support technique ODOT pour plus de détails.

Si le module a une opération de mise à niveau, après l'achèvement de la mise à niveau, le besoin de vérifier que tous les modules sont dans l'état normal avant de courir, sinon il conduira à une exception.

Le fait de ne pas suivre les instructions peut entraîner une défaillance de la protection fournie par l'équipement, ce qui peut entraîner des conséquences graves, comme des blessures ou des dommages à l'équipement.

3.2 Field channel LED indicator (Green)

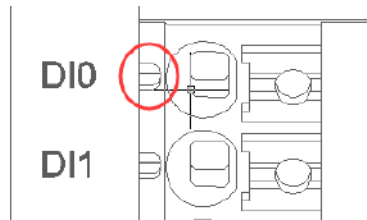

When input signal of input channel is valid, the corresponding field channel LED indicator is on.

3.3 Terminal definition

Terminal Number	Symbol	Description
1	DI0	Signal input
2	DI1	
3	DI2	
4	DI3	
5	DI4	
6	DI5	
7	DI6	
8	DI7	
9	DI8	Signal input
10	DI9	
11	DI10	
12	DI11	
13	DI12	
14	DI13	
15	DI14	
16	DI15	
17	V+	Power input
18	V-	Power input

WARNING

UNEXPECTED EQUIPMENT OPERATION

The DI channel terminal provides reverse protection.

Failure to follow instructions specified by the manufacturer may result in serious consequences such as death, personal injury, or damage to equipment since the protection provided by the equipment may be impaired.

⚠️ AVERTISSEMENT

FONCTIONNEMENT INATTENDU DE L'ÉQUIPEMENT

Le terminal de canal d'entrée numérique offre une protection inverse.

Le fait de ne pas suivre les instructions peut entraîner une défaillance de la protection fournie par l'équipement, ce qui peut entraîner des conséquences graves, comme des blessures ou des dommages à l'équipement.

When connecting a cold-pressed terminal, the terminal must be terminated and checked in strict accordance with the corresponding termination specifications or requirements, and connect the cold-pressed terminal according to the corresponding node serial number. The conductor should use copper conductor and the conductor core should be larger than 0.2mm^2 and smaller than 1mm^2 (AWG18~AWG24). Cold-pressed terminal parameters are as follows:



⚠️ WARNING

UNEXPECTED EQUIPMENT OPERATION

Strip the length of the conductor insulation layer is greater than 10mm to ensure reliable signal connection.

The wire needs to use copper wire and the wire core is greater than or equal to 0.2mm^2 and less than or equal to 1mm^2 to ensure reliable signal connection.

When connecting a cold-press terminal, connect the cold-press terminal strictly in accordance with the corresponding termination specifications or requirements, and connect the cold-press terminal according to the corresponding node serial number.

Do not power on cold-press terminals until they are properly connected or fully locked.

Failure to follow instructions specified by the manufacturer may result in serious consequences such as death, personal injury, or damage to equipment since the protection provided by the equipment may be impaired.

 **AVERTISSEMENT**

FONCTIONNEMENT INATTENDU DE L'EQUIPEMENT

Dépouillez la longueur de la couche isolante du fil plus de 10mm pour assurer la connexion fiable du signal.

Le conducteur doit utiliser le fil de cuivre et le noyau de fil est supérieur ou égal à 0,2 mm², inférieur ou égal à 1mm², afin d'assurer la connexion fiable du signal.

Lorsque les terminaux de presse à froid sont terminés, ils doivent être terminés et visualisés en stricte conformité avec les spécifications ou les exigences correspondantes et terminés selon le numéro de série de noeud correspondant.

Il est interdit d'activer les bornes à froid avant qu'elles ne soient correctement articulées ou complètement verrouillées.

Le fait de ne pas suivre les instructions peut entraîner une défaillance de la protection fournie par l'équipement, ce qui peut entraîner des conséquences graves, comme des blessures ou des dommages à l'équipement.

 **DANGER**

FIRE DANGER

Use the correct wiring rules only for the maximum current capacity of the I/O channel and power supply.

Failure to follow instructions specified by the manufacturer may result in serious consequences such as death, personal injury, or damage to equipment since the protection provided by the equipment may be impaired.

 **WARNING**

UNEXPECTED EQUIPMENT OPERATION

Do not exceed any of the ratings specified in the environmental and electrical characteristics table.

Failure to follow instructions specified by the manufacturer may result in serious consequences such as death, personal injury, or damage to equipment since the protection provided by the equipment may be impaired.

 **AVERTISSEMENT**

FONCTIONNEMENT INATTENDU DE L'EQUIPEMENT

Ne dépassez aucune évaluation spécifiée dans le tableau de caractéristiques environnementales et électriques..

Le fait de ne pas suivre les instructions peut entraîner une défaillance de la protection fournie par l'équipement, ce qui peut entraîner des conséquences graves, comme des blessures ou des dommages à l'équipement.

4 Wiring

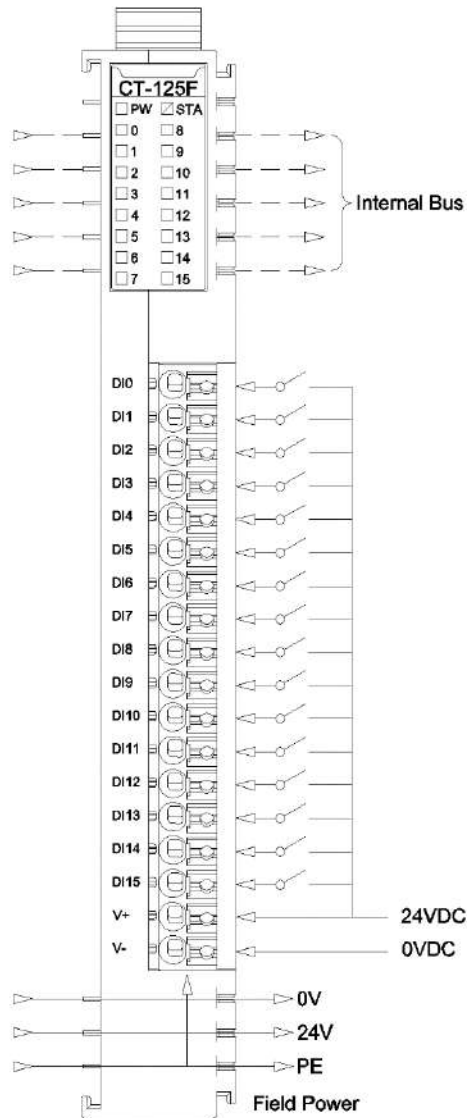

NOTICE

EQUIPMENT INOPERABLE

Do not crimp the spring terminal with more than the maximum pressure specified for the terminal. Otherwise, the resilience of the spring terminal may be damaged and the terminal rebound may be affected.

Do not press the spring terminal with a sharp tool when removing cable from the channel. Otherwise, the spring terminal will be damaged.

Failure to follow these instructions may result in equipment damage.

5 Process data definition

<16DI Input State> Submodule process data definition

Input data								
Bit No	Bit 7	Bit 6	Bit 5	Bit 4	Bit 3	Bit 2	Bit 1	Bit 0
Byte 0	DI Ch#7	DI Ch#6	DI Ch#5	DI Ch#4	DI Ch#3	DI Ch#2	DI Ch#1	DI Ch#0
Byte 1	DI Ch#15	DI Ch#14	DI Ch#13	DI Ch#12	DI Ch#11	DI Ch#10	DI Ch#9	DI Ch#8

Data description:

DI Ch#(0-15): When the corresponding channel input signal is valid, the bit is 1, and when the input is invalid, it is 0.

0: Input signal invalid

1: Input signal valid

<16DI Counter Submodule> Submodule process data definition:

Input data								
Bit No	Bit 7	Bit 6	Bit 5	Bit 4	Bit 3	Bit 2	Bit 1	Bit 0
Byte 0	Counter Value Ch#0							
Byte 1								
Byte 2								
Byte 3								
Byte 4	Counter Value Ch#1							
Byte 5								
Byte 6								
Byte 7								
Byte 8	Counter Value Ch#2							
Byte 9								
Byte 10								
Byte 11								
Byte 12	Counter Value Ch#3							
Byte 13								
Byte 14								
Byte 15								
Byte 16	Counter Value Ch#4							
Byte 17								
Byte 18								
Byte 19								
Byte 20	Counter Value Ch#5							
Byte 21								
Byte 22								

Byte 23								
Byte 24								
Byte 25	Counter Value Ch#6							
Byte 26								
Byte 27								
Byte 28								
Byte 29	Counter Value Ch#7							
Byte 30								
Byte 31								
Byte 32								
Byte 33	Counter Value Ch#8							
Byte 34								
Byte 35								
Byte 36								
Byte 37	Counter Value Ch#9							
Byte 38								
Byte 39								
Byte 40								
Byte 41	Counter Value Ch#10							
Byte 42								
Byte 43								
Byte 44								
Byte 45	Counter Value Ch#11							
Byte 46								
Byte 47								
Byte 48								
Byte 49	Counter Value Ch#12							
Byte 50								
Byte 51								
Byte 52								
Byte 53	Counter Value Ch#13							
Byte 54								
Byte 55								
Byte 56								
Byte 57	Counter Value Ch#14							
Byte 58								
Byte 59								
Byte 60								
Byte 61	Counter Value Ch#15							
Byte 62								
Byte 63								
Byte 63								
Output data								
Bit No	Bit 7	Bit 6	Bit 5	Bit 4	Bit 3	Bit 2	Bit 1	Bit 0
Byte 0	Counter Reset Ch#7	Counter Reset Ch#6	Counter Reset Ch#5	Counter Reset Ch#4	Counter Reset Ch#3	Counter Reset Ch#2	Counter Reset Ch#1	Counter Reset Ch#0

Byte 1	Counter Reset Ch#15	Counter Reset Ch#14	Counter Reset Ch#13	Counter Reset Ch#12	Counter Reset Ch#11	Counter Reset Ch#10	Counter Reset Ch#9	Counter Reset Ch#8
--------	---------------------------	---------------------------	---------------------------	---------------------------	---------------------------	---------------------------	--------------------------	--------------------------

Data description:

Counter Value Ch#(0-15): Count value, 32-bit unsigned integer, automatically zeroing after overflow.

Counter Reset Ch#(0-15): When the data bit changes from 0 to 1 (rising edge), the input counter of the corresponding channel is cleared.

Note:

A. Count submodules can only be configured in submodule slot 2

B. The maximum counting frequency of the input channel is 200Hz. When the input signal exceeds this frequency, the counting result may be inconsistent with the actual value.

<16DI Field Power Check Submodule> Submodule process data definition:

Input data								
Bit No	Bit 7	Bit 6	Bit 5	Bit 4	Bit 3	Bit 2	Bit 1	Bit 0
Byte 0	NULL	NULL	NULL	NULL	NULL	NULL	NULL	DI Ch 0~15

Data description:

DI Ch 0-15: Field power supply detection in the channel. When the corresponding channel input signal is valid, the bit is 1, and when the input is invalid, it is 0.

0: The field power connection is invalid

1: The field power supply is valid

Note: 16-channel field power inspection in submodules can be configured in submodule slot 2 or 3.

6 Configuration parameter definitions

<16DI Input State> Submodule configuration parameter definition

Configuration parameters								
Bit No	Bit 7	Bit 6	Bit 5	Bit 4	Bit 3	Bit 2	Bit 1	Bit 0
Byte 0	Input Filtering Time(ms)							
Byte 1								
Byte 2	Reserved					Input Holding Time(ms)		
Byte 3	Reserved							
Byte 4								

Data description:

Input Filtering Time(ms): Input filter time of Channel (ms) (Default: 10)

Input Holding Time(ms): Signal input holding time of Channel (ms) (Default:0)

- 0: Disable
- 1: 200ms
- 2: 500ms
- 3: 1000ms
- 4: 1500ms
- 5: 2000ms
- 6: 3000ms
- 7: 5000ms

<16DI Counter Submodule> Submodule configuration parameter definition

Configuration parameters								
Bit No	Bit 7	Bit 6	Bit 5	Bit 4	Bit 3	Bit 2	Bit 1	Bit 0
Byte 0	Reserved				Storage Enable	Storage Function	32Bit Data Format	
Byte 1	Count Mode Ch#3		Count Mode Ch#2		Count Mode Ch#1		Count Mode Ch#0	
Byte 2	Count Mode Ch#7		Count Mode Ch#6		Count Mode Ch#5		Count Mode Ch#4	
Byte 3	Count Mode Ch#11		Count Mode Ch#10		Count Mode Ch#9		Count Mode Ch#8	
Byte 4	Count Mode Ch#15		Count Mode Ch#14		Count Mode Ch#13		Count Mode Ch#12	

Byte 5	Count Direction Ch#7	Count Direction Ch#6	Count Direction Ch#5	Count Direction Ch#4	Count Direction Ch#3	Count Direction Ch#2	Count Direction Ch#1	Count Direction Ch#0
Byte 6	Count Direction Ch#15	Count Direction Ch#14	Count Direction Ch#13	Count Direction Ch#12	Count Direction Ch#11	Count Direction Ch#10	Count Direction Ch#9	Count Direction Ch#8

Data description:

32Bit Data Format: Byte transfer order of Channel count value (Default: 0)

- 0: AB-CD
- 1: BA-DC
- 2: CD-AB
- 3: DC-BA

Storage Function: Storage Function is supported or not, read only, and this value is the actual value of the module when uploading device parameters.

- 0: storage is not supported
- 1: storage is supported

Storage Enable: Storage enable, when the Storage Function enables, the IO module will save the count value in real time to non-volatile memory, and load the last saved count value on the next power on. (Default: 1)

- 0: Disabled
- 1: Enable

Count Mode Ch# (0-15): Count mode of the input channel. (Default: 0)

- 0: rising edge count
- 1: falling edge count
- 2: double edge count

Count Direction Ch# (0-15): The counting direction of the input channel. (Default: 0)

- 0: count up
- 1: count down

A Dimension drawing

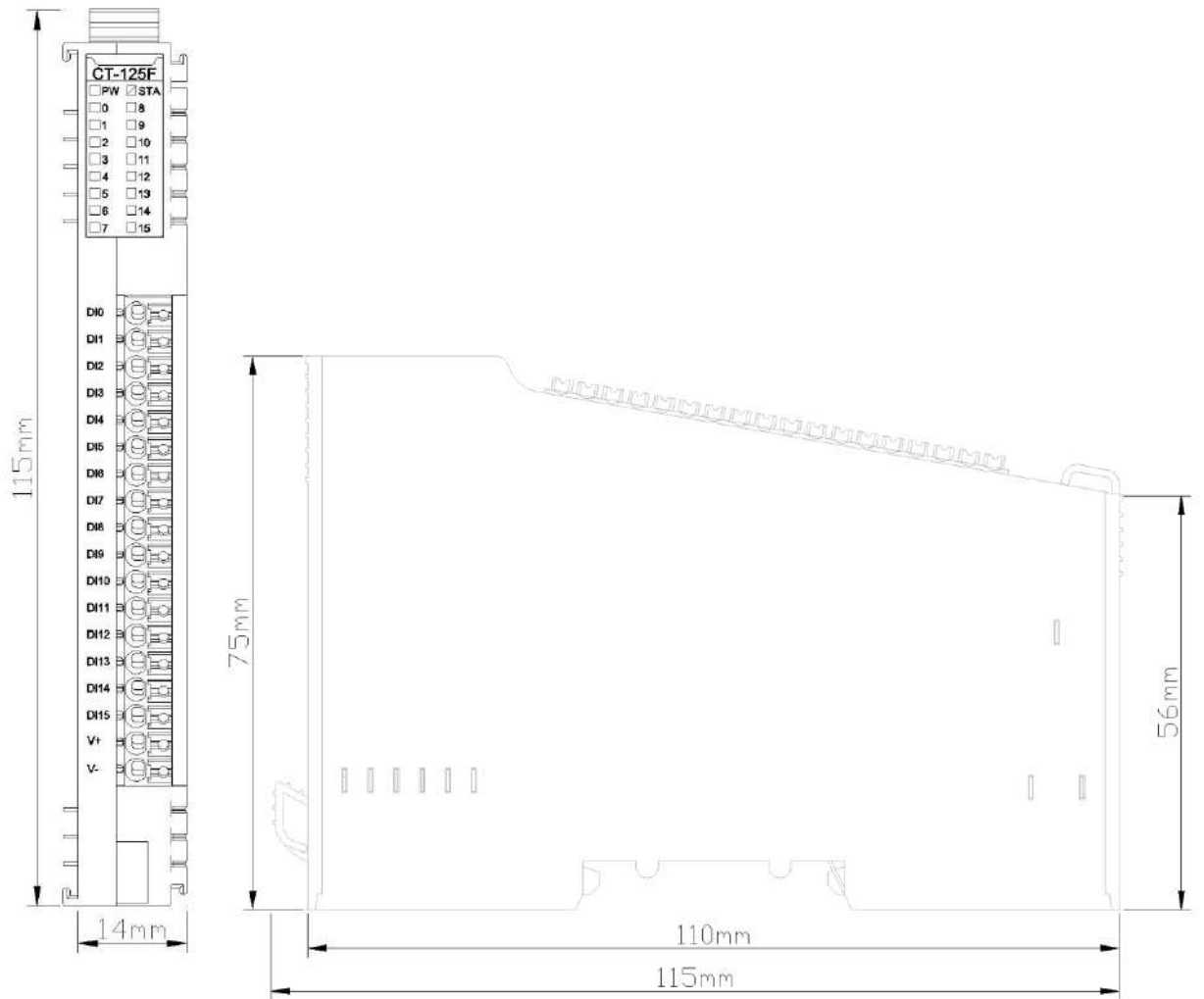

CT-126F 16 channels digital input/24VDC/NPN

1 Module features

- ◆ The Module supports 16 channels digital input, supports source input, the input voltage is 0V and the input low level is valid.
- ◆ The module could collect digital output signal of field equipment (dry contact or active output).
- ◆ The module could be accessed to 2-wire or 3-wire digital sensor.
- ◆ The internal bus and field input of the module is isolated.
- ◆ The module supports the input signal holding function, and the holding time can be set.
- ◆ The module carries 16 digital input channels with LED indicator on each channel.
- ◆ Supports counting function after adding counting sub-module.
- ◆ The field power detection function is effective after the onsite power detection submodule is added
- ◆ Each input channel of the module supports a 32-bit counter with the counting frequency <200Hz.
- ◆ The module could be set the digital signal input filtering time and the byte transmission order of the counter.
- ◆ Each channel of the module could be set the counting mode and counting direction independently.
- ◆ The module input channel loop power supply requires 24VDC external power supply.

2 Technical parameters

General Parameters	
Power Consumption	Max.70mA@5.0VDC
Isolation	The isolation voltage between the I/O channel and the system power supply: AC500V The isolation voltage between the I/O channel and the field power supply: AC500V Isolation voltage between the I/O channel and PE: AC 500V
Field Power	Nominal:24VDC, Range:20.4-28.8VDC
Wiring	Max.: AWG 18 Min.: AWG 24
Installation	35mm DIN-Rail
Size	115*14*75mm
Weight	65g
Environment Specification	
Operating Temperature of Horizontal Installation	-35°C~70°C
Operating Temperature of Vertical Installation	-35°C~60°C
Relative Humidity	< 95%RH (No Condensation)
Storage Temperature	-40°C~85°C
Storage Humidity	< 95%RH (No Condensation)
Manufacturing Test Temperature	-40°C~75°C
Ingress Protection Rating	IP20
Input Parameters	
Channel Number	16 channel source input
LED Indicator	16 channel input LED indicator
Input type	IEC 61131-2 Tyepe3
Turn-on Voltage	Min. 11VDC to Max. -27VDC ((Relative to 24V terminal)
Turn-off Voltage	Min. -5VDC to Max. 6VDC ((Relative to 24V terminal)
Turn-on Current	13VDC 3.820mA
Input impedance	>2.5kΩ
Input Delay	OFF to ON: Max. 2.035ms ON to OFF: Max. 1ms
Filter Time	Default 10ms
Sample Frequency	500Hz
Counter Frequency	<200Hz
Effective pulse width for counting	2.5ms
EMC parameters	
Static Electricity	Air 8KV/ Contact 4KV`

EFT	2KV
Surge	2KV

WARNING

UNEXPECTED EQUIPMENT OPERATION

Do not exceed any of the ratings specified in the environmental and electrical characteristics table.

Failure to follow instructions specified by the manufacturer may result in serious consequences such as death, personal injury, or damage to equipment since the protection provided by the equipment may be impaired.

AVERTISSEMENT

FONCTIONNEMENT INATTENDU DE L'EQUIPEMENT

Ne dépassez aucune évaluation spécifiée dans le tableau de caractéristiques environnementales et électriques.

Le fait de ne pas suivre les instructions peut entraîner une défaillance de la protection fournie par l'équipement, ce qui peut entraîner des conséquences graves, comme des blessures ou des dommages à l'équipement.

3 Hardware interfaces

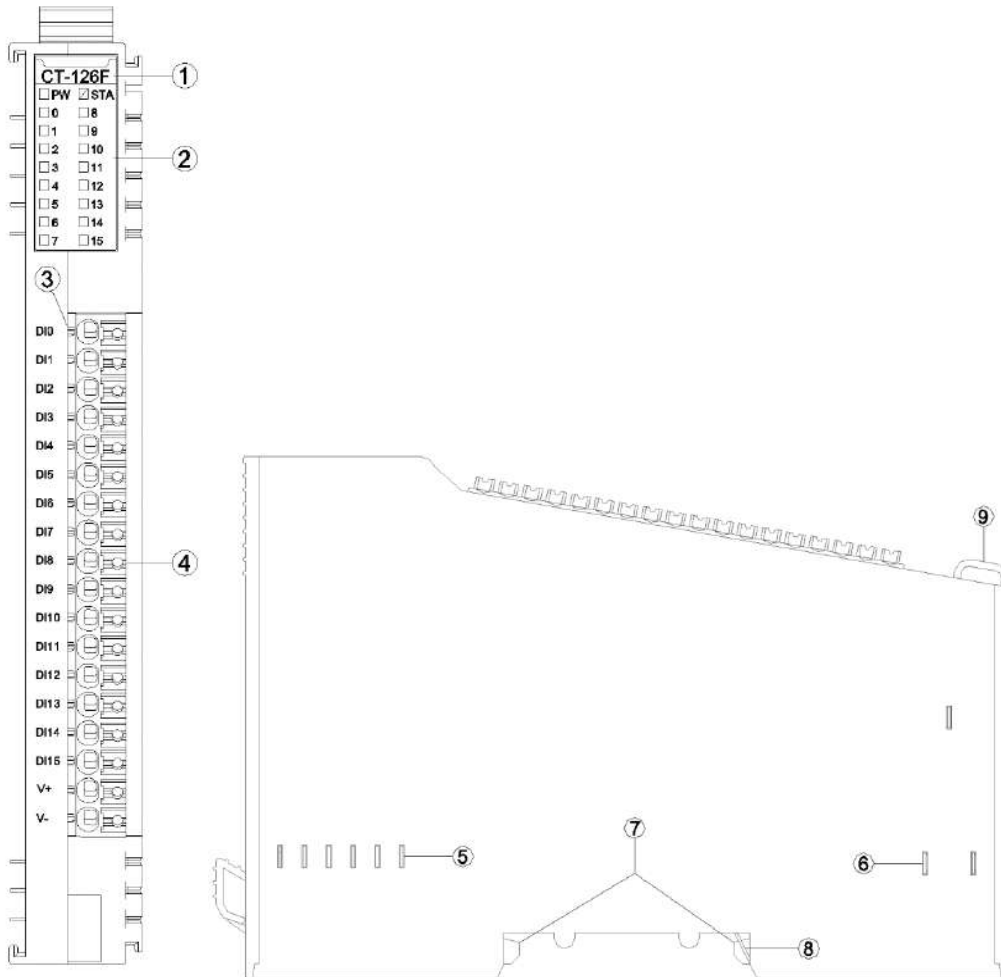

- ① Module Type
- ② State indicator
- ③ Channel indicator
- ④ Wiring Terminal and identification
- ⑤ Internal Bus
- ⑥ Field Power
- ⑦ Buckle
- ⑧ Grounding Spring Sheet
- ⑨ Fixed Wiring Harness

3.1 LED indicator definition

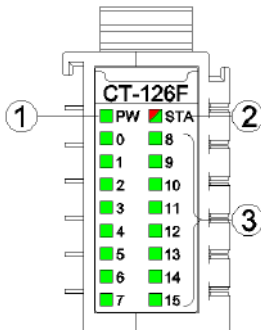

- ① Power LED indicator (green)
- ② Module State LED indicator (red/green)
- ③ Input channel LED indicator (green)

PW Power State (GREEN)	Definition
ON	Internal bus Power Normal
OFF	Internal bus Power Failure
STA Module State (RED/GREEN)	Definition
Green slow flash (2.5Hz)	Module internal bus is not started
Red slow flash (2.5Hz)	Module internal bus offline
ON (GREEN)	Operation normal
Flash(2.5Hz) (RED/GREEN)	Upgrading mode
Flash(10Hz) (RED/GREEN)	Firmware Update
Double Flash (RED)	Module Exception has been soft-restarted
0-15 channel indicator light	Definition
ON	Input signal valid
OFF	Input signal invalid

WARNING

UNEXPECTED EQUIPMENT OPERATION

By viewing the PW indicator, could determine the power supply status of a module. If the PW is steady green, the power supply is normal. Otherwise, the module cannot work properly.

When the module is initially powered on, there will be 3S for the backplane bus connection. After the backplane bus is initialized, STA is in the green steady state. If STA is in the green blinking state, it indicates that the backplane bus has not been

initialized, and it needs to be powered off and restarted for re-initialization.

STA abnormal working state occurs during the normal operation of the module, please check the firmware version information of all modules, and consult ODOT technical support for details.

If a module is upgraded, check that all modules are in the normal state after the upgrade. Otherwise, an exception may occur.

Failure to follow instructions specified by the manufacturer may result in serious consequences such as death, personal injury, or damage to equipment since the protection provided by the equipment may be impaired.

AVERTISSEMENT

FONCTIONNEMENT INATTENDU DE L'EQUIPEMENT

En regardant l'état de l'indicateur de PW, jugez l'état d'alimentation du module. Le feu vert PW reste allumé et l'alimentation est normale. Autrement, le module ne fonctionnera pas correctement.

Lorsque le module est alimenté initialement, il y aura 3S pour la connexion de bus de backboard. STA est un état vert permanent après l'initialisation du bus de backboard. Si STA est en état de clignotement vert, cela signifie que l'initialisation du bus de backboard n'est pas passée et doit être redémarrée hors tension et réinitialisée.

L'état de fonctionnement anormal de STA se produit pendant le fonctionnement normal du module, veuillez vérifier les informations de version du firmware de tous les modules, et consulter le support technique ODOT pour plus de détails.

Si le module a une opération de mise à niveau, après l'achèvement de la mise à niveau, le besoin de vérifier que tous les modules sont dans l'état normal avant de courir, sinon il conduira à une exception.

Le fait de ne pas suivre les instructions peut entraîner une défaillance de la protection fournie par l'équipement, ce qui peut entraîner des conséquences graves, comme des blessures ou des dommages à l'équipement.

3.2 Field channel LED indicator (Green)

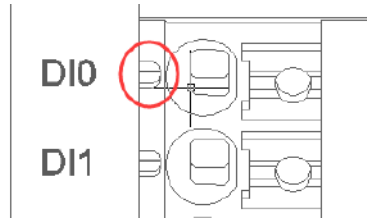

When input signal of input channel is valid, the corresponding field channel LED indicator is on.

3.3 Terminal definition

Terminal Number	Symbol	Description
1	DI0	Signal input
2	DI1	
3	DI2	
4	DI3	
5	DI4	
6	DI5	
7	DI6	
8	DI7	
9	DI8	Signal input
10	DI9	
11	DI10	
12	DI11	
13	DI12	
14	DI13	
15	DI14	
16	DI15	
17	V+	Power input
18	V-	Power input

WARNING

UNEXPECTED EQUIPMENT OPERATION

The DI channel terminal provides reverse protection.

Failure to follow instructions specified by the manufacturer may result in serious consequences such as death, personal injury, or damage to equipment since the protection provided by the equipment may be impaired.

⚠️ AVERTISSEMENT

FONCTIONNEMENT INATTENDU DE L'ÉQUIPEMENT

Le terminal de canal d'entrée numérique offre une protection inverse.

Le fait de ne pas suivre les instructions peut entraîner une défaillance de la protection fournie par l'équipement, ce qui peut entraîner des conséquences graves, comme des blessures ou des dommages à l'équipement.

When connecting a cold-pressed terminal, the terminal must be terminated and checked in strict accordance with the corresponding termination specifications or requirements, and connect the cold-pressed terminal according to the corresponding node serial number. The conductor should use copper conductor and the conductor core should be larger than 0.2mm^2 and smaller than 1mm^2 (AWG18~AWG24). Cold-pressed terminal parameters are as follows:

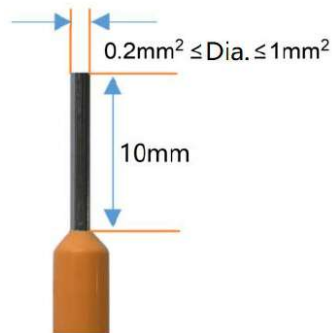

⚠️ WARNING

UNEXPECTED EQUIPMENT OPERATION

Strip the length of the conductor insulation layer is greater than 10mm to ensure reliable signal connection.

The wire needs to use copper wire and the wire core is greater than or equal to 0.2mm^2 and less than or equal to 1mm^2 to ensure reliable signal connection.

When connecting a cold-press terminal, connect the cold-press terminal strictly in accordance with the corresponding termination specifications or requirements, and connect the cold-press terminal according to the corresponding node serial number.

Do not power on cold-press terminals until they are properly connected or fully locked.

Failure to follow instructions specified by the manufacturer may result in serious consequences such as death, personal injury, or damage to equipment since the protection provided by the equipment may be impaired.

 **AVERTISSEMENT**

FONCTIONNEMENT INATTENDU DE L'EQUIPEMENT

Dépouillez la longueur de la couche isolante du fil plus de 10mm pour assurer la connexion fiable du signal.

Le conducteur doit utiliser le fil de cuivre et le noyau de fil est supérieur ou égal à 0,2 mm², inférieur ou égal à 1mm², afin d'assurer la connexion fiable du signal.

Lorsque les terminaux de presse à froid sont terminés, ils doivent être terminés et visualisés en stricte conformité avec les spécifications ou les exigences correspondantes et terminés selon le numéro de série de noeud correspondant.

Il est interdit d'activer les bornes à froid avant qu'elles ne soient correctement articulées ou complètement verrouillées.

Le fait de ne pas suivre les instructions peut entraîner une défaillance de la protection fournie par l'équipement, ce qui peut entraîner des conséquences graves, comme des blessures ou des dommages à l'équipement.

 **DANGER**

FIRE DANGER

Use the correct wiring rules only for the maximum current capacity of the I/O channel and power supply.

Failure to follow instructions specified by the manufacturer may result in serious consequences such as death, personal injury, or damage to equipment since the protection provided by the equipment may be impaired.

 **WARNING**

UNEXPECTED EQUIPMENT OPERATION

Do not exceed any of the ratings specified in the environmental and electrical characteristics table.

Failure to follow instructions specified by the manufacturer may result in serious consequences such as death, personal injury, or damage to equipment since the protection provided by the equipment may be impaired.

 **AVERTISSEMENT**

FONCTIONNEMENT INATTENDU DE L'EQUIPEMENT

Ne dépassez aucune évaluation spécifiée dans le tableau de caractéristiques environnementales et électriques..

Le fait de ne pas suivre les instructions peut entraîner une défaillance de la protection fournie par l'équipement, ce qui peut entraîner des conséquences graves, comme des blessures ou des dommages à l'équipement.

4 Wiring

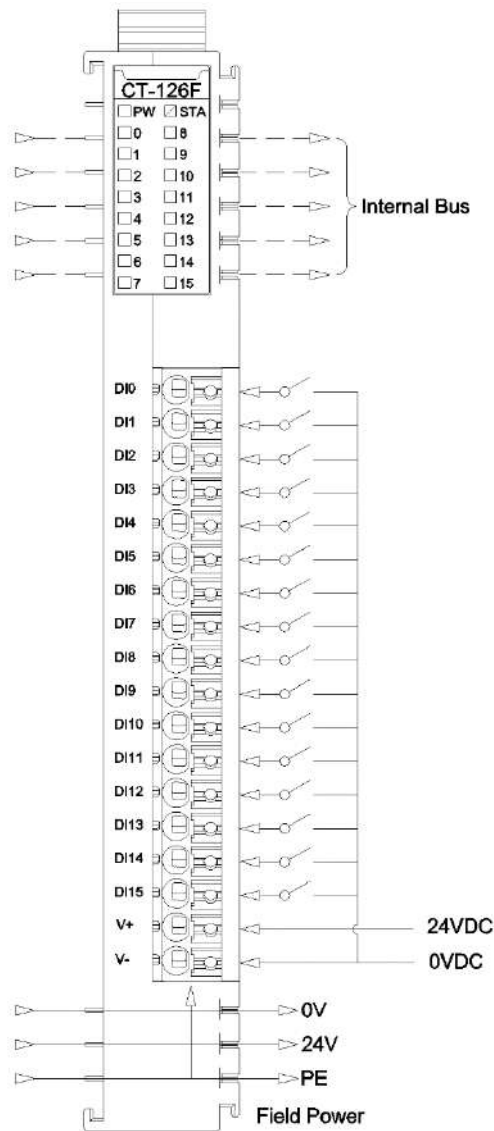

NOTICE

EQUIPMENT INOPERABLE

Do not crimp the spring terminal with more than the maximum pressure specified for the terminal. Otherwise, the resilience of the spring terminal may be damaged and the terminal rebound may be affected.

Do not press the spring terminal with a sharp tool when removing cable from the channel. Otherwise, the spring terminal will be damaged.

Failure to follow these instructions may result in equipment damage.

5 Process data definition

<16DI Input State> Submodule process data definition

Input data								
Bit No	Bit 7	Bit 6	Bit 5	Bit 4	Bit 3	Bit 2	Bit 1	Bit 0
Byte 0	DI Ch#7	DI Ch#6	DI Ch#5	DI Ch#4	DI Ch#3	DI Ch#2	DI Ch#1	DI Ch#0
Byte 1	DI Ch#15	DI Ch#14	DI Ch#13	DI Ch#12	DI Ch#11	DI Ch#10	DI Ch#9	DI Ch#8

Data description:

DI Ch#(0-15): When the corresponding channel input signal is valid, the bit is 1, and when the input is invalid, it is 0.

0: Input signal invalid

1: Input signal valid

<16DI Counter Submodule> Submodule process data definition:

Input data								
Bit No	Bit 7	Bit 6	Bit 5	Bit 4	Bit 3	Bit 2	Bit 1	Bit 0
Byte 0	Counter Value Ch#0							
Byte 1								
Byte 2								
Byte 3								
Byte 4	Counter Value Ch#1							
Byte 5								
Byte 6								
Byte 7								
Byte 8	Counter Value Ch#2							
Byte 9								
Byte 10								
Byte 11								
Byte 12	Counter Value Ch#3							
Byte 13								
Byte 14								
Byte 15								
Byte 16	Counter Value Ch#4							
Byte 17								
Byte 18								
Byte 19								
Byte 20	Counter Value Ch#5							
Byte 21								
Byte 22								

Byte 23								
Byte 24								
Byte 25	Counter Value Ch#6							
Byte 26								
Byte 27								
Byte 28								
Byte 29	Counter Value Ch#7							
Byte 30								
Byte 31								
Byte 32								
Byte 33	Counter Value Ch#8							
Byte 34								
Byte 35								
Byte 36								
Byte 37	Counter Value Ch#9							
Byte 38								
Byte 39								
Byte 40								
Byte 41	Counter Value Ch#10							
Byte 42								
Byte 43								
Byte 44								
Byte 45	Counter Value Ch#11							
Byte 46								
Byte 47								
Byte 48								
Byte 49	Counter Value Ch#12							
Byte 50								
Byte 51								
Byte 52								
Byte 53	Counter Value Ch#13							
Byte 54								
Byte 55								
Byte 56								
Byte 57	Counter Value Ch#14							
Byte 58								
Byte 59								
Byte 60								
Byte 61	Counter Value Ch#15							
Byte 62								
Byte 63								
Byte 63								
Output data								
Bit No	Bit 7	Bit 6	Bit 5	Bit 4	Bit 3	Bit 2	Bit 1	Bit 0
Byte 0	Counter Reset Ch#7	Counter Reset Ch#6	Counter Reset Ch#5	Counter Reset Ch#4	Counter Reset Ch#3	Counter Reset Ch#2	Counter Reset Ch#1	Counter Reset Ch#0

Byte 1	Counter Reset Ch#15	Counter Reset Ch#14	Counter Reset Ch#13	Counter Reset Ch#12	Counter Reset Ch#11	Counter Reset Ch#10	Counter Reset Ch#9	Counter Reset Ch#8
--------	---------------------------	---------------------------	---------------------------	---------------------------	---------------------------	---------------------------	--------------------------	--------------------------

Data description:

Counter Value Ch#(0-15): Count value, 32-bit unsigned integer, automatically zeroing after overflow.

Counter Reset Ch#(0-15): When the data bit changes from 0 to 1 (rising edge), the input counter of the corresponding channel is cleared.

Note:

A. Count submodules can only be configured in submodule slot 2

B. The maximum counting frequency of the input channel is 200Hz. When the input signal exceeds this frequency, the counting result may be inconsistent with the actual value.

<16DI Field Power Check Submodule> Submodule process data definition:

Input data								
Bit No	Bit 7	Bit 6	Bit 5	Bit 4	Bit 3	Bit 2	Bit 1	Bit 0
Byte 0	NULL	NULL	NULL	NULL	NULL	NULL	NULL	DI Ch 0~15

Data description:

DI Ch 0-15: Field power supply detection in the channel. When the corresponding channel input signal is valid, the bit is 1, and when the input is invalid, it is 0.

0: The field power connection is invalid

1: The field power supply is valid

Note: 16-channel field power inspection in submodules can be configured in submodule slot 2 or 3.

6 Configuration parameter definitions

<16DI Input State> Submodule configuration parameter definition

Configuration parameters								
Bit No	Bit 7	Bit 6	Bit 5	Bit 4	Bit 3	Bit 2	Bit 1	Bit 0
Byte 0	Input Filtering Time(ms)							
Byte 1								
Byte 2	Reserved					Input Holding Time(ms)		
Byte 3	Reserved							
Byte 4								

Data description:

Input Filtering Time(ms): Input filter time of Channel (ms) (Default: 10)

Input Holding Time(ms): Signal input holding time of Channel (ms) (Default:0)

- 0: Disable
- 1: 200ms
- 2: 500ms
- 3: 1000ms
- 4: 1500ms
- 5: 2000ms
- 6: 3000ms
- 7: 5000ms

<16DI Counter Submodule> Submodule configuration parameter definition

Configuration parameters								
Bit No	Bit 7	Bit 6	Bit 5	Bit 4	Bit 3	Bit 2	Bit 1	Bit 0
Byte 0	Reserved				Storage Enable	Storage Function	32Bit Data Format	
Byte 1	Count Mode Ch#3		Count Mode Ch#2		Count Mode Ch#1		Count Mode Ch#0	
Byte 2	Count Mode Ch#7		Count Mode Ch#6		Count Mode Ch#5		Count Mode Ch#4	
Byte 3	Count Mode Ch#11		Count Mode Ch#10		Count Mode Ch#9		Count Mode Ch#8	
Byte 4	Count Mode Ch#15		Count Mode Ch#14		Count Mode Ch#13		Count Mode Ch#12	

Byte 5	Count Direction Ch#7	Count Direction Ch#6	Count Direction Ch#5	Count Direction Ch#4	Count Direction Ch#3	Count Direction Ch#2	Count Direction Ch#1	Count Direction Ch#0
Byte 6	Count Direction Ch#15	Count Direction Ch#14	Count Direction Ch#13	Count Direction Ch#12	Count Direction Ch#11	Count Direction Ch#10	Count Direction Ch#9	Count Direction Ch#8

Data description:

32Bit Data Format: Byte transfer order of Channel count value (Default: 0)

- 0: AB-CD
- 1: BA-DC
- 2: CD-AB
- 3: DC-BA

Storage Function: Storage Function is supported or not, read only, and this value is the actual value of the module when uploading device parameters.

- 0: storage is not supported
- 1: storage is supported

Storage Enable: Storage enable, when the Storage Function enables, the IO module will save the count value in real time to non-volatile memory, and load the last saved count value on the next power on. (Default: 1)

- 0: Disabled
- 1: Enable

Count Mode Ch# (0-15): Count mode of the input channel. (Default: 0)

- 0: rising edge count
- 1: falling edge count
- 2: double edge count

Count Direction Ch# (0-15): The counting direction of the input channel. (Default: 0)

- 0: count up
- 1: count down

A Dimension drawing

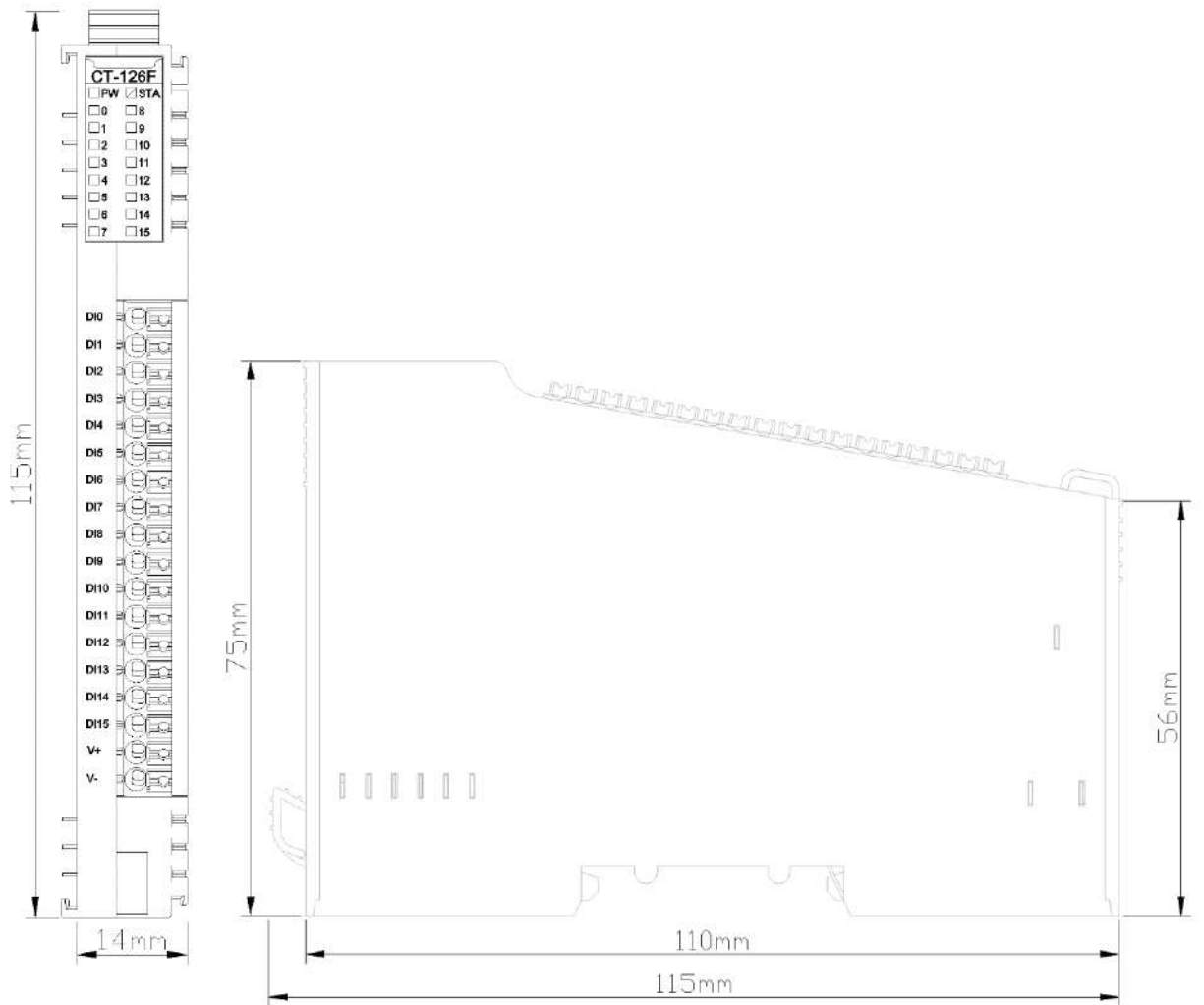

CT-1314 4 channels digital input/220VAC

1 Module features

- ◆ The module supports 4 channels of digital input and 220V AC input.
- ◆ The module could collect the digital output signal of the field equipment (dry contact or active output).
- ◆ The module could be connected to 2-wire or 3-wire digital sensor.
- ◆ 4 channels of the module are isolated, isolation voltage between channels is 3000VAC.
- ◆ The internal bus of the module and the field input are isolated by optical coupling.
- ◆ The module supports input signal holding function, holding time can be set.
- ◆ The module carries with 4 digital input channel LED indicators.
- ◆ After adding the counting submodule, the count function is available.
- ◆ Each input channel of the module supports 32-bit counter, count frequency <10Hz.
- ◆ The module could be set the digital signal input filtering time and the counter byte transmission sequence.
- ◆ Each channel of the module could be independently set counting mode and counting direction.

2 Technical parameters

General Parameters	
Power Consumption	Max.27mA@5.0VDC/25°C
Isolation	The isolation voltage between the I/O channel and the system power supply: AC3000V Isolation voltage between the I/O channel and PE: AC 3000V Isolation voltage between I/O channels: AC 3000V
Field Power	\
Wiring	Max.: AWG 18 Min.: AWG 24
Installation Method	35mm DIN-Rail
Size	115*14*75mm
Weight	65g
Environment Specification	
Operating Temperature of Horizontal Installation	-35°C~70°C
Operating Temperature of Vertical Installation	-35°C~60°C
Relative Humidity	< 95%RH (No Condensation)
Storage Temperature	-40°C~85°C
Storage Humidity	< 95%RH (No Condensation)
Manufacturing Test Temperature	-40°C~75°C
Ingress Protection Rating	IP20
Input Parameters	
Channel Number	4 channel inputs
LED Indicator	4-channel input indicator 4 panel indicators 1 power indicator 1 dual-color indicator
Input Type	Conforms to IEC 61131-2 Type3 input type
Overvoltage category	OVC II
Opening Voltage	159VAC~264VAC
Turn-off Voltage	0VAC~40VAC
Nominal Voltage	230VAC
Opening Current	Min.7mA/channel@220VAC/25°C
Input Impedance	>32kΩ
Input Delay	OFF to ON:Max.8ms ON to OFF:Max.20.5ms
Filtering Time	Default 20ms
Counting Frequency	<10Hz
EMC parameters	
Static Electricity	Air±8KV
EFT	±2KV
Surge	±2KV

 **WARNING**

UNEXPECTED EQUIPMENT OPERATION

Do not exceed any of the ratings specified in the environmental and electrical characteristics table.

Failure to follow instructions specified by the manufacturer may result in serious consequences such as death, personal injury, or damage to equipment since the protection provided by the equipment may be impaired.

 **AVERTISSEMENT**

FONCTIONNEMENT INATTENDU DE L'EQUIPEMENT

Ne dépassez aucune évaluation spécifiée dans le tableau de caractéristiques environnementales et électriques..

Le fait de ne pas suivre les instructions peut entraîner une défaillance de la protection fournie par l'équipement, ce qui peut entraîner des conséquences graves, comme des blessures ou des dommages à l'équipement.

3 Hardware interface

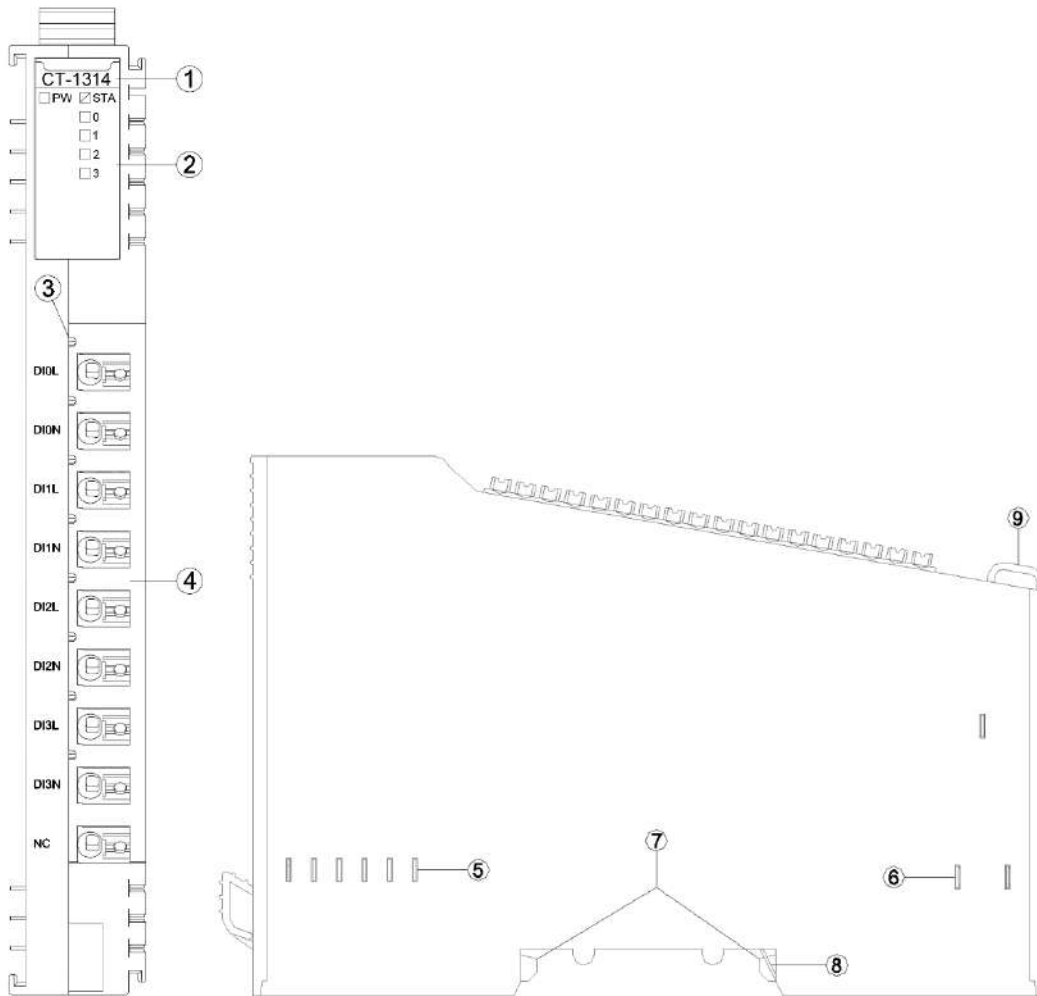

- ① Module Type
- ② State indicator
- ③ Channel indicator
- ④ Wiring Terminal and identification
- ⑤ Internal Bus
- ⑥ Field Power
- ⑦ Buckle
- ⑧ Grounding Spring Sheet
- ⑨ Fixed Wiring Harness

3.1 LED Indicator Definition

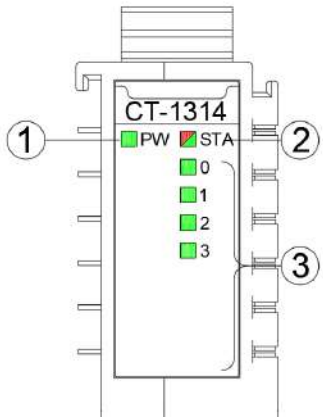

- ① Power LED indicator (green)
- ② Module State LED indicator (red/green)
- ③ Input channel LED indicator (green)

PW power state (GREEN)	Definition
ON	The internal bus power supply is normal
OFF	The internal bus power supply is abnormal
STA module state (RED/GREEN)	Definition
Green Slow Flashing (2.5Hz)	The module's internal bus is not started
Red Slow Flashing (2.5Hz)	The internal bus of the module is offline
On (GREEN)	Operation normal
Flash(2.5Hz) (RED/GREEN)	Upgrading mode
Flash(10Hz) (RED/GREEN)	Firmware Upgrading
Double Flash (RED)	Module exception and program has been soft-restarted
0-3 channel indicator (GREEN)	Definition
ON	The input signal is valid
OFF	The input signal is invalid

WARNING

UNEXPECTED EQUIPMENT OPERATION

By viewing the PW indicator, could determine the power supply status of a module. If the PW is steady green, the power supply is normal. Otherwise, the module cannot work properly.

When the module is initially powered on, there will be 3S for the backplane bus connection. After the backplane bus is initialized, STA is in the green steady state. If STA is in the green blinking state, it indicates that the backplane bus has not been initialized, and it needs to be powered off and restarted for re-initialization.

STA abnormal working state occurs during the normal operation of the module, please check the firmware version information of all modules, and consult ODOT technical support for details.

If a module is upgraded, check that all modules are in the normal state after the upgrade. Otherwise, an exception may occur.

Failure to follow instructions specified by the manufacturer may result in serious consequences such as death, personal injury, or damage to equipment since the protection provided by the equipment may be impaired.

AVERTISSEMENT

FONCTIONNEMENT INATTENDU DE L'EQUIPEMENT

En regardant l'état de l'indicateur de PW, jugez l'état d'alimentation du module. Le feu vert PW reste allumé et l'alimentation est normale. Autrement, le module ne fonctionnera pas correctement.

Lorsque le module est alimenté initialement, il y aura 3S pour la connexion de bus de backboard. STA est un état vert permanent après l'initialisation du bus de backboard. Si STA est en état de clignotement vert, cela signifie que l'initialisation du bus de backboard n'est pas passée et doit être redémarrée hors tension et réinitialisée.

L'état de fonctionnement anormal de STA se produit pendant le fonctionnement normal du module, veuillez vérifier les informations de version du firmware de tous les modules, et consulter le support technique ODOT pour plus de détails.

Si le module a une opération de mise à niveau, après l'achèvement de la mise à niveau, le besoin de vérifier que tous les modules sont dans l'état normal avant de courir, sinon il conduira à une exception.

Le fait de ne pas suivre les instructions peut entraîner une défaillance de la protection fournie par l'équipement, ce qui peut entraîner des conséquences graves, comme des blessures ou des dommages à l'équipement.

3.2 Field channel LED indicator (Green)

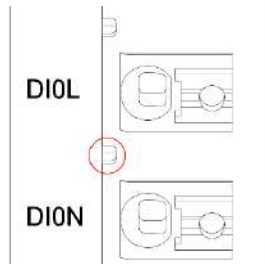

When the input signal of the input channel is valid, the corresponding field channel indicator is on.

3.3 Terminal definition

Terminal serial number	Symbol	Illustrate
1	DI0L	Channel 0
2	DI0N	
3	DI1L	Channel 1
4	DI1N	
5	DI2L	Channel 2
6	DI2N	
7	DI3L	Channel 3
8	DI3N	
9	NC	Not connected

! WARNING

UNEXPECTED EQUIPMENT OPERATION

Calculate the maximum field power current consumption of a single module based on the actual field load. If the total field power current consumption of all I/O modules exceeds the power supply capacity of the field power supply, you must add an extra power expansion module. Otherwise, an output channel exception may occur.

Failure to follow instructions specified by the manufacturer may result in serious consequences such as death, personal injury, or damage to equipment since the protection provided by the equipment may be impaired.

! AVERTISSEMENT

FONCTIONNEMENT INATTENDU DE L'EQUIPEMENT

Calculez la consommation maximale de courant de champ d'un seul module en fonction de la charge de champ réelle. Si la consommation totale de courant de champ de tous les modules d'E/S dépasse la capacité d'alimentation de l'alimentation de champ, vous devez ajouter un module d'extension de puissance supplémentaire. Dans le cas contraire, une exception de canal de sortie peut se produire.

Le fait de ne pas suivre les instructions peut entraîner une défaillance de la protection fournie par l'équipement, ce qui peut entraîner des conséquences graves, comme des blessures ou des dommages à l'équipement.

When connecting a cold-pressed terminal, the terminal must be terminated and checked in strict accordance with the corresponding termination specifications or requirements, and connect the cold-pressed terminal according to the corresponding node serial number. The conductor should use copper conductor and the conductor core should be larger than 0.2mm^2 and smaller than 1mm^2 (AWG18~AWG24). Cold-pressed terminal parameters are as follows:



! WARNING

UNEXPECTED EQUIPMENT OPERATION

Strip the length of the conductor insulation layer is greater than 10mm to ensure reliable signal connection.

The wire needs to use copper wire and the wire core is greater than or equal to 0.2mm^2 and less than or equal to 1mm^2 to ensure reliable signal connection.

When connecting a cold-press terminal, connect the cold-press terminal strictly in accordance with the corresponding termination specifications or requirements, and connect the cold-press terminal according to the corresponding node serial number.

Do not power on cold-press terminals until they are properly connected or fully locked.

Failure to follow instructions specified by the manufacturer may result in serious consequences such as death, personal injury, or damage to equipment since the protection provided by the equipment may be impaired.

! AVERTISSEMENT

FONCTIONNEMENT INATTENDU DE L'EQUIPEMENT

Dépouillez la longueur de la couche isolante du fil plus de 10mm pour assurer la connexion fiable du signal.

Le conducteur doit utiliser le fil de cuivre et le noyau de fil est supérieur ou égal à $0,2\text{ mm}^2$, inférieur ou égal à 1mm^2 , afin d'assurer la connexion fiable du signal.

Lorsque les terminaux de presse à froid sont terminés, ils doivent être terminés et visualisés en

stricte conformité avec les spécifications ou les exigences correspondantes et terminés selon le numéro de série de noeud correspondant.

Il est interdit d'activer les bornes à froid avant qu'elles ne soient correctement articulées ou complètement verrouillées.

Le fait de ne pas suivre les instructions peut entraîner une défaillance de la protection fournie par l'équipement, ce qui peut entraîner des conséquences graves, comme des blessures ou des dommages à l'équipement.

DANGER

FIRE DANGER

Use the correct wiring rules only for the maximum current capacity of the I/O channel and power supply.

Failure to follow instructions specified by the manufacturer may result in serious consequences such as death, personal injury, or damage to equipment since the protection provided by the equipment may be impaired.

WARNING

UNEXPECTED EQUIPMENT OPERATION

Do not exceed any of the ratings specified in the environmental and electrical characteristics table.

Failure to follow instructions specified by the manufacturer may result in serious consequences such as death, personal injury, or damage to equipment since the protection provided by the equipment may be impaired.

AVERTISSEMENT

FONCTIONNEMENT INATTENDU DE L'EQUIPEMENT

Ne dépassez aucune évaluation spécifiée dans le tableau de caractéristiques environnementales et électriques..

Le fait de ne pas suivre les instructions peut entraîner une défaillance de la protection fournie par l'équipement, ce qui peut entraîner des conséquences graves, comme des blessures ou des dommages à l'équipement.

4 Wiring

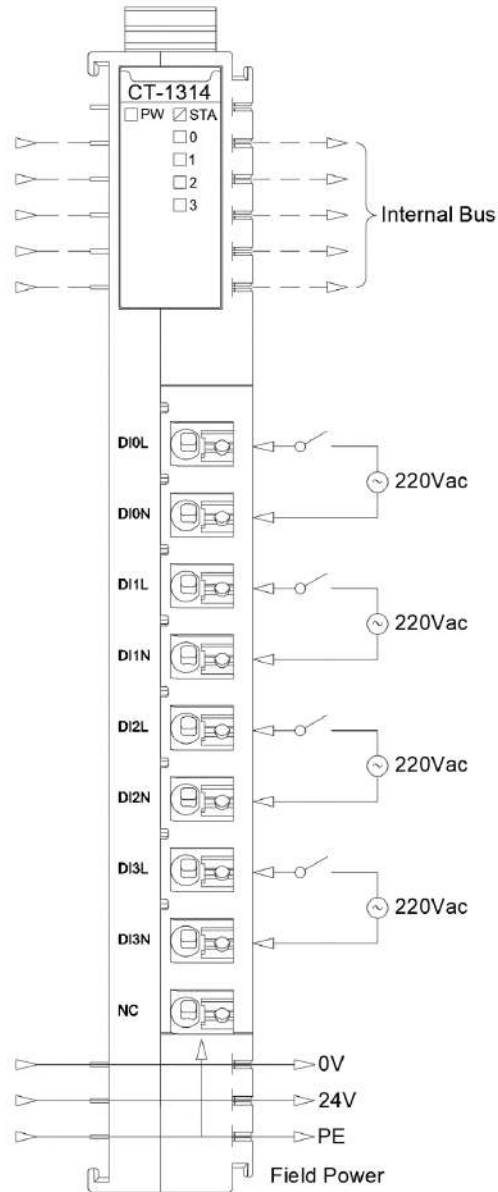

NOTICE

EQUIPMENT INOPERABLE

Do not crimp the spring terminal with more than the maximum pressure specified for the terminal. Otherwise, the resilience of the spring terminal may be damaged and the terminal rebound may be affected.

Do not press the spring terminal with a sharp tool when removing cable from the channel. Otherwise, the spring terminal will be damaged.

Failure to follow these instructions may result in equipment damage.

5 Process Data Definition

<4DI Input Status > Submodule process data definition

Enter the data								
Bit No	Bit 7	Bit 6	Bit 5	Bit 4	Bit 3	Bit 2	Bit 1	Bit 0
Byte 0	Reserved				DI Ch#3	DI Ch#2	DI Ch#1	DI Ch#0

Data Description:

DI Ch# (0-3): When the input signal of the corresponding channel is valid, this bit is forced to 1, and when the input is invalid, it is 0.

0: The input signal is invalid, and the input signal voltage range is 0-40VAC

1: The input signal is valid, and the input signal voltage range is 159-264VAC

<4DI Counter Submodule > Counter Submodule process data definition

Input data								
Bit No	Bit 7	Bit 6	Bit 5	Bit 4	Bit 3	Bit 2	Bit 1	Bit 0
Byte 0	Counter Value Ch#0							
Byte 1								
Byte 2								
Byte 3								
Byte 4	Counter Value Ch#1							
Byte 5								
Byte 6								
Byte 7								
Byte 8	Counter Value Ch#2							
Byte 9								
Byte 10								
Byte 11								
Byte 12	Counter Value Ch#3							
Byte 13								
Byte 14								
Byte 15								
Output data								
Bit No	Bit 7	Bit 6	Bit 5	Bit 4	Bit 3	Bit 2	Bit 1	Bit 0
Byte 0	Reserved				Counter Reset Ch#3	Counter Reset Ch#2	Counter Reset Ch#1	Counter Reset Ch#0

Data Description:

Counter Value Ch#(0-3): Count value, 32-bit unsigned integer, automatically zeroing after overflow.

Counter Reset Ch# (0-3): When the data bit changes from 0 to 1 (rising edge), the input counter of the corresponding channel is zeroing.

Note: the maximum counting frequency of the input channel is 10Hz. When the input signal exceeds this frequency, the counting result may be inconsistent with the actual value.

6 Configuration parameter definitions

<4DI Input Status > Submodule configuration parameter definition

Configure parameters								
Bit No	Bit 7	Bit 6	Bit 5	Bit 4	Bit 3	Bit 2	Bit 1	Bit 0
Byte 0	Input Filtering Time(ms)							
Byte 1								
Byte 2	Reserved						Input Holding Time(ms)	
Byte 3	Reserved							

Data Description:

Input Filtering Time (ms): Input filter time of channel (ms) (Default: 20)

Input Holding Time (ms): Signal input holding time of channel (ms) (Default:0)

- 0: Disable
- 1: 200ms
- 2: 500ms
- 3: 1000ms
- 4: 1500ms
- 5: 2000ms
- 6: 3000ms
- 7: 5000ms

<4DI Counter Submodule > Submodule configuration parameter definition

Configure parameters									
Bit No	Bit 7	Bit 6	Bit 5	Bit 4	Bit 3	Bit 2	Bit 1	Bit 0	
Byte 0	Reserved				Storage Enable	Storage Function	32Bit Data Format		
Byte 1	Count Mode Ch#3		Count Mode Ch#2		Count Mode Ch#1		Count Mode Ch#0		
Byte 2	Reserved				Count Direction Ch#3	Count Direction Ch#2	Count Direction Ch#1	Count Direction Ch#0	
Byte 3	Reserved								

Data Description:

32Bit Data Format: Byte transmission sequence of channel count value (Default: 0)

- 0: AB-CD

1: BA-DC

2: CD-AB

3: DC-BA

Storage Function: Storage Function is supported or not, read only, and this value is the actual value of the module when uploading device parameters.

0: Storage is not supported

1: Storage is supported

Storage Enable: Storage enable, when the Storage Function enables, the IO module will save the count value in real time to non-volatile memory, and load the last saved count value on the next power on. (Default: 1)

0: Disable

1: Enable

Count Mode Ch#(0-3):Count mode of the input channel. (Default: 0).

0: Rising edge count

1: Falling edge count

2: Bilateral edge count

Count Direction Ch#(0-3): The counting direction of the input channel. (Default: 0)

0: Count up

1: Count down

A Dimensional drawing

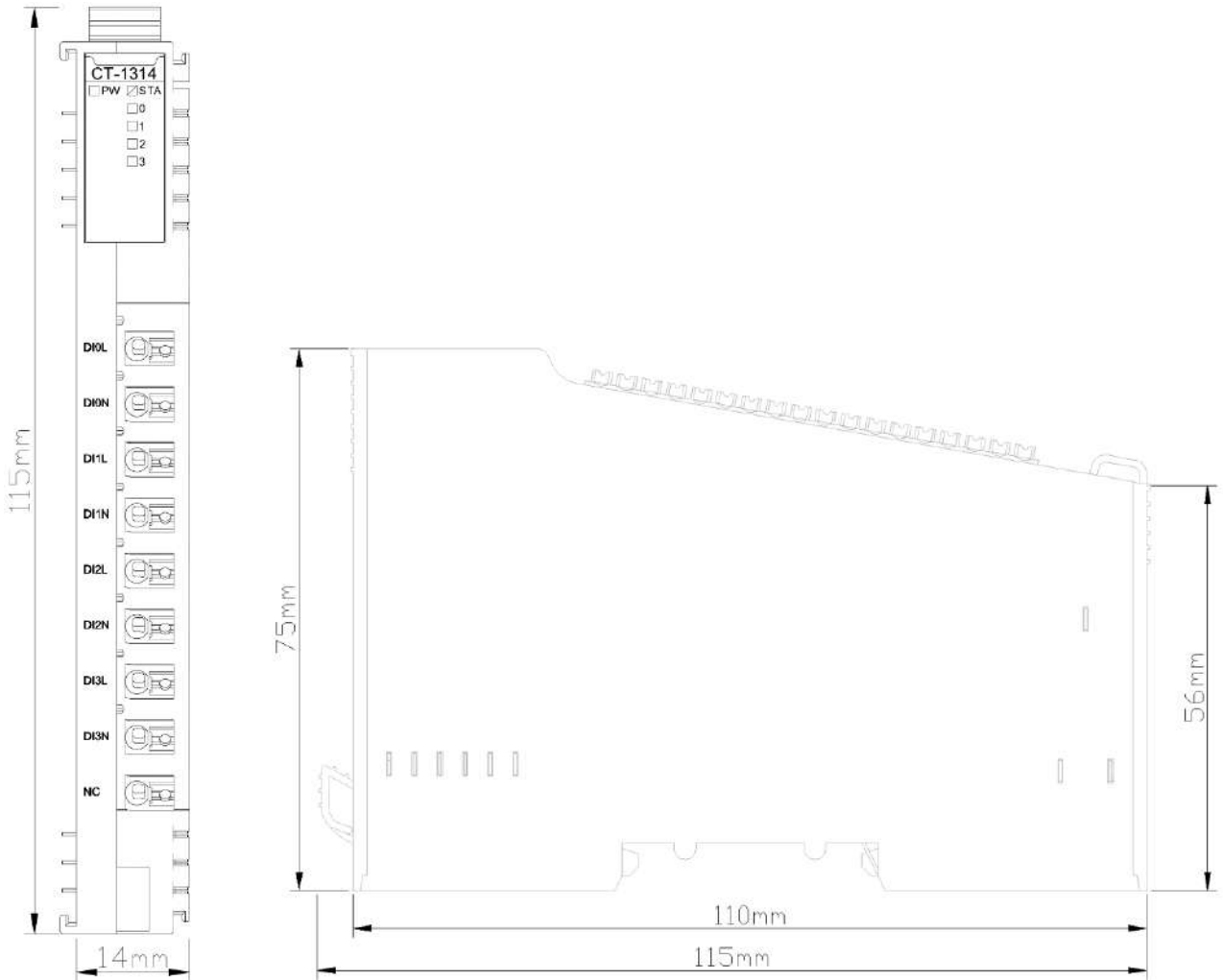

CT-2224 4 channels digital output/24VDC/ PNP

1 Module features

- ◆ The module supports 4-channel digital output, the output voltage is 24VDC and the output high level is valid.
- ◆ The max output current of DO single channel is 2.2 A.
- ◆ The module could drive field equipment (relay, solenoid valve, etc.)
- ◆ The module internal bus and field output are isolated by optocoupler
- ◆ The module carries with 4 digital output channel LED indicator
- ◆ The module has the functions of thermal shutdown and overcurrent protection
- ◆ The module supports short circuit protection and overload protection

2 Technical Parameters

General Parameters	
Power Consumption	Max.30mA@5.0VDC
Isolation	I/O to internal bus: opto-couple isolation (3KVrms)
Field Power	Nominal:24VDC, Range: 20.4~28.8VDC
Wiring	Max.: AWG 18 Min.: AWG 24
Installation	35mm DIN-Rail
Size	115*14*75mm
Weight	65g
Environment Specification	
Operating Temperature of Horizontal Installation	-35°C~70°C
Operating Temperature of Vertical Installation	-35°C~60°C
Relative Humidity	< 95%RH (No Condensation)
Storage Temperature	-40°C~85°C
Storage Humidity	< 95%RH (No Condensation)
Manufacturing Test Temperature	-40°C~75°C
Ingress Protection Rating	IP20
Output Parameters	
Channel Number	4 Channels
LED Indicator	4 Channels output LED Indicator
Rated Current	Typical value: 2.2A
Leak Current	Max. value: 10uA
Output Impedance	<90mΩ
Output Delay	OFF to ON:Max.5us ON to OFF:Max.200us
Protection Function	Over temperature turn-off: typical value 150°C Overcurrent protection: typical value 12A
Load type	General use and Resistive, Pilot Duty

 **WARNING**

UNEXPECTED EQUIPMENT OPERATION

Do not exceed any of the ratings specified in the environmental and electrical characteristics table.

Failure to follow instructions specified by the manufacturer may result in serious consequences such as death, personal injury, or damage to equipment since the protection provided by the equipment may be impaired.

 **AVERTISSEMENT**

FONCTIONNEMENT INATTENDU DE L'EQUIPEMENT

Ne dépassez aucune évaluation spécifiée dans le tableau de caractéristiques environnementales et électriques..

Le fait de ne pas suivre les instructions peut entraîner une défaillance de la protection fournie par l'équipement, ce qui peut entraîner des conséquences graves, comme des blessures ou des dommages à l'équipement.

3 Hardware Interface

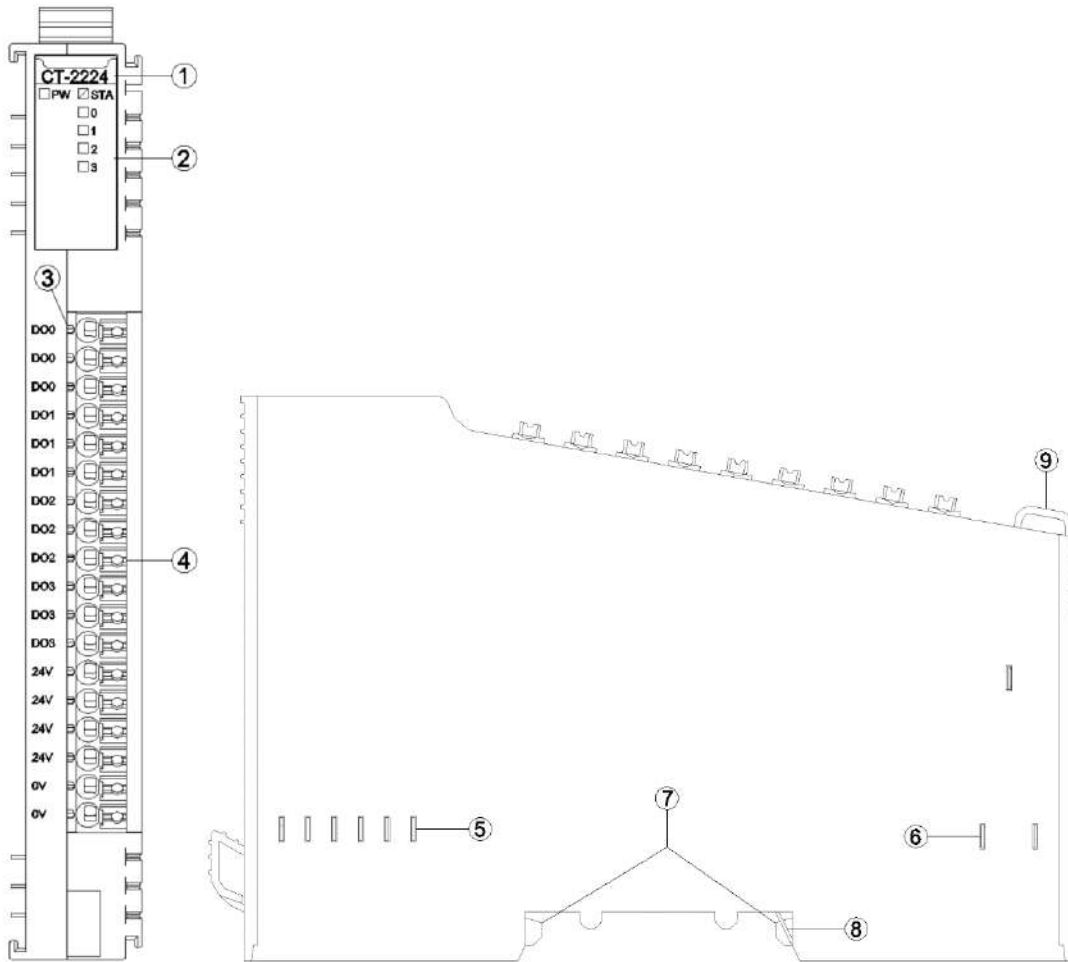

- ① Module Type
- ② State indicator
- ③ Channel indicator
- ④ Wiring Terminal and identification
- ⑤ Internal Bus
- ⑥ Field Power
- ⑦ Buckle
- ⑧ Grounding Spring Sheet
- ⑨ Fixed Wiring Harness

3.1 LED indicator definition

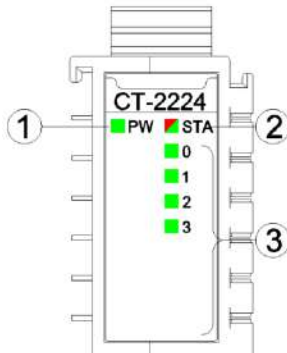

- ① Power LED indicator (green)
- ② Module State LED indicator (red/green)
- ③ Output channel LED indicator (green)

PW Power State (GREEN)	Definition
ON	Internal bus Power Normal
OFF	Internal bus Power Failure
STA Module State (RED/GREEN)	Definition
Green slow flash (2.5Hz)	Module internal bus is not started
Red slow flash (2.5Hz)	Module internal bus offline
ON (GREEN)	Operation normal
Flash(2.5Hz) (RED/GREEN)	Upgrading mode
Flash(10Hz) (RED/GREEN)	Firmware Update
Double Flash (RED)	Module Exception has been soft-restarted
0-3 channel LED indicator (GREEN)	Definition
ON	Output signal valid
OFF	Output signal invalid

! WARNING

UNEXPECTED EQUIPMENT OPERATION

By viewing the PW indicator, could determine the power supply status of a module. If the PW is steady green, the power supply is normal. Otherwise, the module cannot work properly.

When the module is initially powered on, there will be 3S for the backplane bus connection. After the backplane bus is initialized, STA is in the green steady state. If STA is in the green blinking state, it indicates that the backplane bus has not been initialized, and it needs to be powered off and restarted for re-initialization.

STA abnormal working state occurs during the normal operation of the module, please check the firmware version information of all modules, and consult ODOT technical support for details.

If a module is upgraded, check that all modules are in the normal state after the upgrade.

Otherwise, an exception may occur.

Failure to follow instructions specified by the manufacturer may result in serious consequences such as death, personal injury, or damage to equipment since the protection provided by the equipment may be impaired.

! AVERTISSEMENT

FONCTIONNEMENT INATTENDU DE L'EQUIPEMENT

En regardant l'état de l'indicateur de PW, jugez l'état d'alimentation du module. Le feu vert PW reste allumé et l'alimentation est normale. Autrement, le module ne fonctionnera pas correctement.

Lorsque le module est alimenté initialement, il y aura 3S pour la connexion de bus de backboard. STA est un état vert permanent après l'initialisation du bus de backboard. Si STA est en état de clignotement vert, cela signifie que l'initialisation du bus de backboard n'est pas passée et doit être redémarrée hors tension et réinitialisée.

L'état de fonctionnement anormal de STA se produit pendant le fonctionnement normal du module, veuillez vérifier les informations de version du firmware de tous les modules, et consulter le support technique ODOT pour plus de détails.

Si le module a une opération de mise à niveau, après l'achèvement de la mise à niveau, le besoin de vérifier que tous les modules sont dans l'état normal avant de courir, sinon il conduira à une exception.

Le fait de ne pas suivre les instructions peut entraîner une défaillance de la protection fournie par l'équipement, ce qui peut entraîner des conséquences graves, comme des blessures ou des dommages à l'équipement.

3.2 Field channel LED indicator (Green)

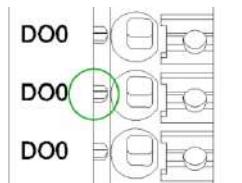

When the output signal of the output channel is valid, the corresponding field channel LED indicator is on.

3.3 Terminal definition

Terminal Number	Symbol	Description
1	DO0	Signal output
2	DO0	
3	DO0	
4	DO1	
5	DO1	
6	DO1	
7	DO2	
8	DO2	
9	DO2	
10	DO3	
11	DO3	
12	DO3	
13	24V	Power input (<i>Note1</i>)
14	24V	
15	24V	
16	24V	
17	0V	
18	0V	

Note 1: The module must be connected to a 24V power supply. Otherwise, the module cannot work properly. The input power of the power supply must be greater than that of all channel loads.

WARNING

UNEXPECTED EQUIPMENT OPERATION

Calculate the maximum field power current consumption of a single module based on the actual field load. If the total field power current consumption of all I/O modules exceeds the power supply capacity of the field power supply, you must add an extra power expansion module. Otherwise, an output channel exception may occur.

Failure to follow instructions specified by the manufacturer may result in serious consequences such as death, personal injury, or damage to equipment since the protection provided by the equipment may be impaired.

AVERTISSEMENT

FONCTIONNEMENT INATTENDU DE L'EQUIPEMENT

Calculez la consommation maximale de courant de champ d'un seul module en fonction de la charge de champ réelle. Si la consommation totale de courant de champ de tous les modules d'E/S dépasse la capacité d'alimentation de l'alimentation de champ, vous devez ajouter un module d'extension de puissance supplémentaire. Dans le cas contraire, une exception de canal de sortie peut se produire.

Le fait de ne pas suivre les instructions peut entraîner une défaillance de la protection fournie par l'équipement, ce qui peut entraîner des conséquences graves, comme des blessures ou des dommages à l'équipement.

When connecting a cold-pressed terminal, the terminal must be terminated and checked in strict accordance with the corresponding termination specifications or requirements, and connect the cold-pressed terminal according to the corresponding node serial number. The conductor should use copper conductor and the conductor core should be larger than 0.2mm^2 and smaller than 1mm^2 (AWG18~AWG24). Cold-pressed terminal parameters are as follows:

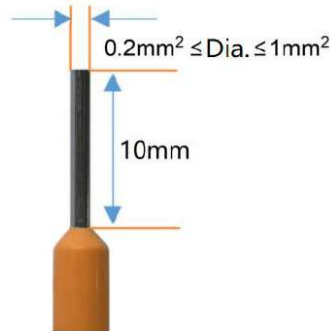

! WARNING

UNEXPECTED EQUIPMENT OPERATION

Strip the length of the conductor insulation layer is greater than 10mm to ensure reliable signal connection.

The wire needs to use copper wire and the wire core is greater than or equal to 0.2mm^2 and less than or equal to 1mm^2 to ensure reliable signal connection.

When connecting a cold-press terminal, connect the cold-press terminal strictly in accordance with the corresponding termination specifications or requirements, and connect the cold-press terminal according to the corresponding node serial number.

Do not power on cold-press terminals until they are properly connected or fully locked.

Failure to follow instructions specified by the manufacturer may result in serious consequences such as death, personal injury, or damage to equipment since the protection provided by the equipment may be impaired.

! AVERTISSEMENT

FONCTIONNEMENT INATTENDU DE L'EQUIPEMENT

Dépouillez la longueur de la couche isolante du fil plus de 10mm pour assurer la connexion fiable du signal.

Le conducteur doit utiliser le fil de cuivre et le noyau de fil est supérieur ou égal à $0,2\text{ mm}^2$, inférieur ou égal à 1mm^2 , afin d'assurer la connexion fiable du signal.

Lorsque les terminaux de presse à froid sont terminés, ils doivent être terminés et visualisés en stricte conformité avec les spécifications ou les exigences correspondantes et terminés selon le numéro de série de noeud correspondant.

Il est interdit d'activer les bornes à froid avant qu'elles ne soient correctement articulées ou complètement verrouillées.

Le fait de ne pas suivre les instructions peut entraîner une défaillance de la protection fournie

par l'équipement, ce qui peut entraîner des conséquences graves, comme des blessures ou des dommages à l'équipement.

DANGER

FIRE DANGER

Use the correct wiring rules only for the maximum current capacity of the I/O channel and power supply.

Failure to follow instructions specified by the manufacturer may result in serious consequences such as death, personal injury, or damage to equipment since the protection provided by the equipment may be impaired.

WARNING

UNEXPECTED EQUIPMENT OPERATION

Do not exceed any of the ratings specified in the environmental and electrical characteristics table.

Failure to follow instructions specified by the manufacturer may result in serious consequences such as death, personal injury, or damage to equipment since the protection provided by the equipment may be impaired.

AVERTISSEMENT

FONCTIONNEMENT INATTENDU DE L'EQUIPEMENT

Ne dépassez aucune évaluation spécifiée dans le tableau de caractéristiques environnementales et électriques..

Le fait de ne pas suivre les instructions peut entraîner une défaillance de la protection fournie par l'équipement, ce qui peut entraîner des conséquences graves, comme des blessures ou des dommages à l'équipement.

4 Wiring

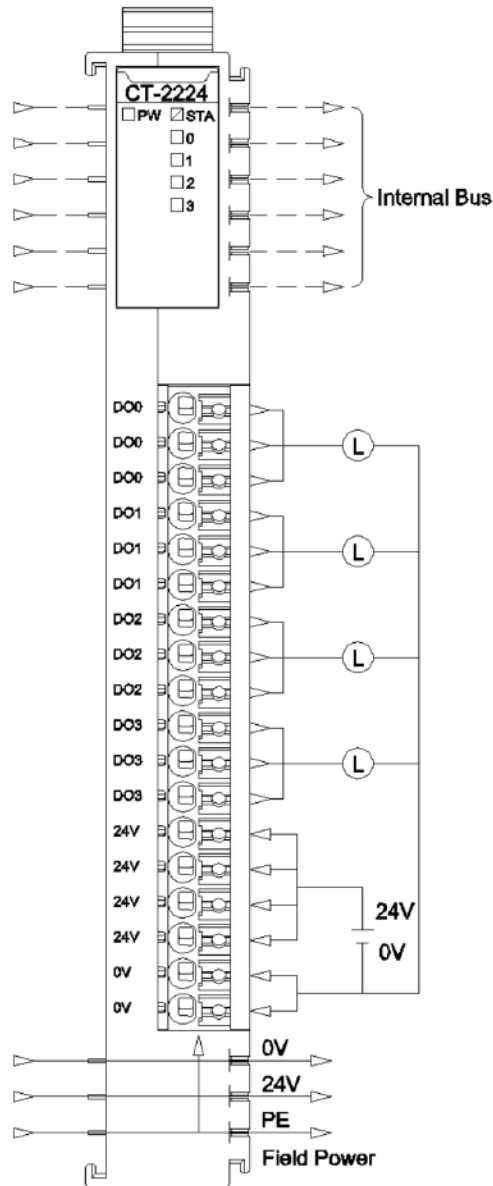

NOTICE

EQUIPMENT INOPERABLE

Do not crimp the spring terminal with more than the maximum pressure specified for the terminal. Otherwise, the resilience of the spring terminal may be damaged and the terminal rebound may be affected.

Do not press the spring terminal with a sharp tool when removing cable from the channel. Otherwise, the spring terminal will be damaged.

Failure to follow these instructions may result in equipment damage.

5 Process data definition

Output Data								
Bit No	Bit 7	Bit 6	Bit 5	Bit 4	Bit 3	Bit 2	Bit 1	Bit 0
Byte 0	Reserve				DO Ch#3	DO Ch#2	DO Ch#1	DO Ch#0

Data description:

DO Ch#(0-3): When the bit is 1, the output signal of the corresponding channel is effective, the output is high level, and the output is invalid when it is 0.

0: The output signal is invalid

1: The output signal is valid

6 Configuration parameters definition

Configured Parameter								
Bit No	Bit 7	Bit 6	Bit 5	Bit 4	Bit 3	Bit 2	Bit 1	Bit 0
Byte 0	Reserve				Fault Action for Output Ch#3	Fault Action for Output Ch#2	Fault Action for Output Ch#1	Fault Action for Output Ch#0
Byte 1	Reserve				Fault Value for Output Ch#3	Fault Value for Output Ch#2	Fault Value for Output Ch#1	Fault Value for Output Ch#0

Data description:

Fault Action for Output Ch#(0-3): When IO module detects the internal bus communication is abnormal and enters offline mode, and output data will be processed in this mode. (Default: 0)

0: Hold Last Output State

1: Output Fault Value

Fault Value for Output Ch#(0-3): When the fault output mode is 1, this bit sets the fault output value, and when the internal bus of IO module is offline, this setting value will be output.(Default: 0)

0: Output low level.

1: Output high level.

A Dimension drawing

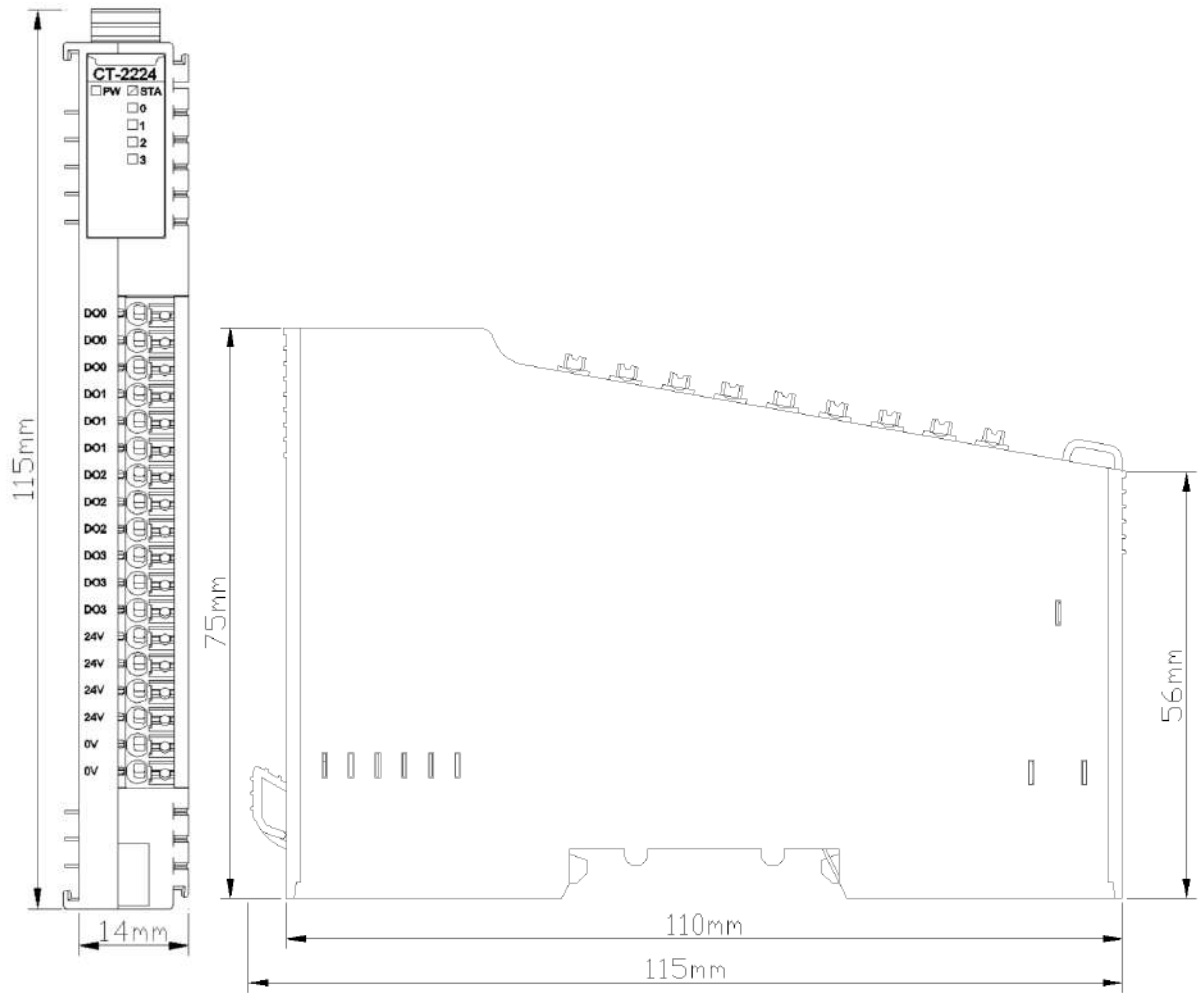

CT-2218 8 channels digital output/24VDC/NPN

1 Module features

- ◆ The module supports 8-channel digital output, the output voltage is 0VDC and the output low level is valid.
- ◆ The module could drive field equipment (relay, solenoid valve, etc.).
- ◆ The module internal bus and field output are isolated by optocoupler.
- ◆ The module carries with 8 digital output channel LED indicator.
- ◆ The module has the functions of thermal shutdown and short-circuit protection.

2 Technical Parameters

General Parameters	
Power Consumption	Max.64mA@5.0VDC
Isolation	I/O to internal bus: opto-couple isolation (3KVrms)
Field Power	Nominal:24VDC, Range:20.4-28.8VDC
Wiring	Max.: AWG 18 Min.: AWG 24
Installation	35mm DIN-Rail
Size	115*14*75mm
Weight	65g
Vibration Resistance	Comply with IEC 61131-2 and EC 60068-2-6
Impact resistance	Comply with IEC 61131-2 and IEC 60068-2-27
EMC Performance	Comply with IEC 61131-2 and IEC 61000-4
Environment Specification	
Operating Temperature of Horizontal Installation	-35°C~70°C
Operating Temperature of Vertical Installation	-35°C~60°C
Relative Humidity	< 95%RH (No Condensation)
Storage Temperature	-40°C~85°C
Storage Humidity	< 95%RH (No Condensation)
Manufacturing Test Temperature	-40°C~75°C
Ingress Protection Rating	IP20
Output Parameters	
Channel Number	8 Channels
LED Indicator	8 channels output LED indicator
Rated Current	Single channel output: Max. 1000mA The total output of the module: Max.4A/8 Channels
Leak Current	Max. value: 3uA
Output Impedance	< 200mΩ
Output Delay	OFF to ON:Max.50us ON to OFF:Max.300us
Protection Function	Over temperature shutdown: typical 135°C Overcurrent protection: typical value 3A Short-circuit protection: Supported
Load type	General use and Resistive, Pilot Duty

 **WARNING**

UNEXPECTED EQUIPMENT OPERATION

Do not exceed any of the ratings specified in the environmental and electrical characteristics table.

Failure to follow instructions specified by the manufacturer may result in serious consequences such as death, personal injury, or damage to equipment since the protection provided by the equipment may be impaired.

 **AVERTISSEMENT**

FONCTIONNEMENT INATTENDU DE L'EQUIPEMENT

Ne dépassez aucune évaluation spécifiée dans le tableau de caractéristiques environnementales et électriques..

Le fait de ne pas suivre les instructions peut entraîner une défaillance de la protection fournie par l'équipement, ce qui peut entraîner des conséquences graves, comme des blessures ou des dommages à l'équipement.

3 Hardware Interface

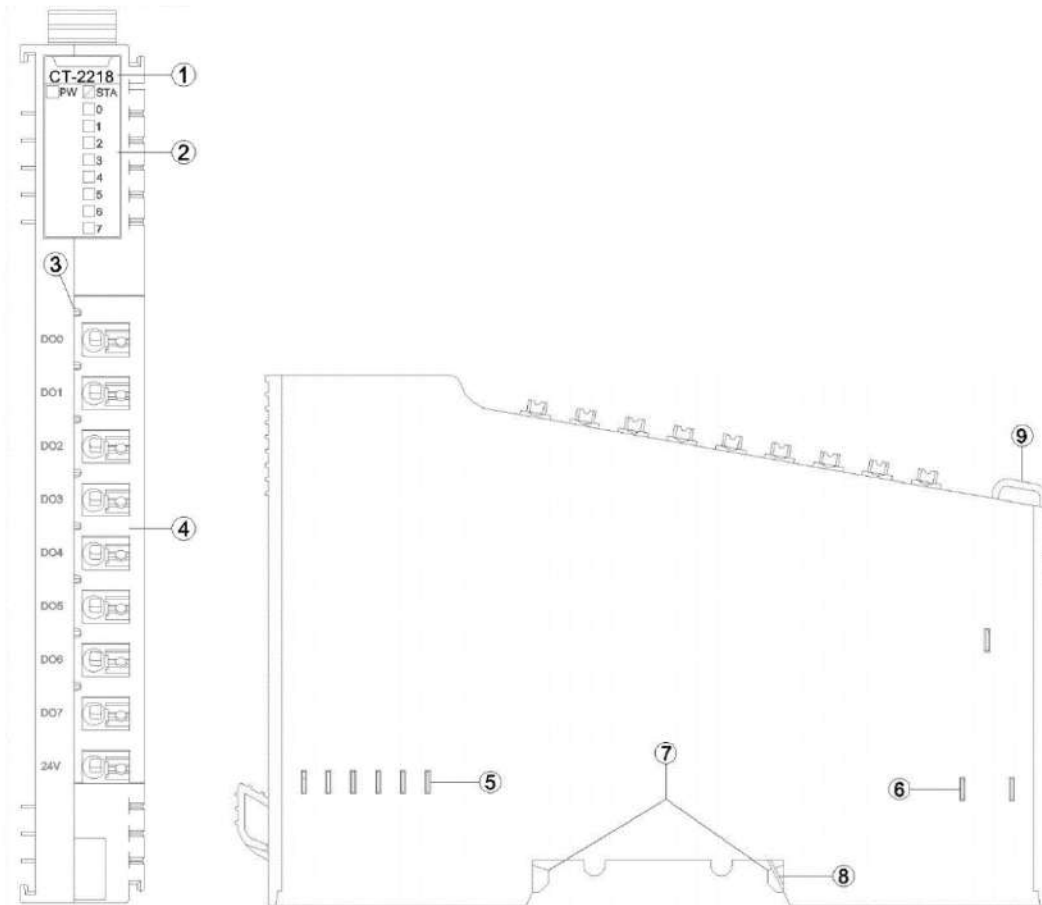

- ① Module Type
- ② State indicator
- ③ Channel indicator
- ④ Wiring Terminal and identification
- ⑤ Internal Bus
- ⑥ Field Power
- ⑦ Buckle
- ⑧ Grounding Spring Sheet
- ⑨ Fixed Wiring Harness

3.1 LED indicator definition

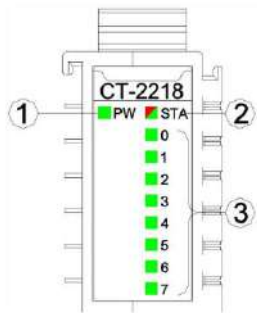

- ① Power LED indicator (green)
- ② Module state LED indicator (red/green)
- ③ Output channel LED indicator (green)

PW Power State (GREEN)	Definition
ON	Internal bus Power Normal
OFF	Internal bus Power Failure
STA Module State (RED/GREEN)	Definition
Green slow flash (2.5Hz)	Module internal bus is not started
Red slow flash (2.5Hz)	Module internal bus offline
ON (GREEN)	Operation normal
Flash(2.5Hz) (RED/GREEN)	Upgrading mode
Flash(10Hz) (RED/GREEN)	Firmware Update
Double Flash (RED)	Module Exception has been soft-restarted
0-7 channel LED indicator (GREEN)	Definition
ON	Output signal valid
OFF	Output signal invalid

! WARNING

UNEXPECTED EQUIPMENT OPERATION

By viewing the PW indicator, could determine the power supply status of a module. If the PW is steady green, the power supply is normal. Otherwise, the module cannot work properly.

When the module is initially powered on, there will be 3S for the backplane bus connection. After the backplane bus is initialized, STA is in the green steady state. If STA is in the green blinking state, it indicates that the backplane bus has not been initialized, and it needs to be powered off and restarted for re-initialization.

STA abnormal working state occurs during the normal operation of the module, please check the firmware version information of all modules, and consult ODOT technical support for details.

If a module is upgraded, check that all modules are in the normal state after the upgrade. Otherwise, an exception may occur.

Failure to follow instructions specified by the manufacturer may result in serious consequences such as death, personal injury, or damage to equipment since the protection provided by the equipment may be impaired.

AVERTISSEMENT

FONCTIONNEMENT INATTENDU DE L'EQUIPEMENT

En regardant l'état de l'indicateur de PW, jugez l'état d'alimentation du module. Le feu vert PW reste allumé et l'alimentation est normale. Autrement, le module ne fonctionnera pas correctement.

Lorsque le module est alimenté initialement, il y aura 3S pour la connexion de bus de backboard. STA est un état vert permanent après l'initialisation du bus de backboard. Si STA est en état de clignotement vert, cela signifie que l'initialisation du bus de backboard n'est pas passée et doit être redémarrée hors tension et réinitialisée.

L'état de fonctionnement anormal de STA se produit pendant le fonctionnement normal du module, veuillez vérifier les informations de version du firmware de tous les modules, et consulter le support technique ODOT pour plus de détails.

Si le module a une opération de mise à niveau, après l'achèvement de la mise à niveau, le besoin de vérifier que tous les modules sont dans l'état normal avant de courir, sinon il conduira à une exception.

Le fait de ne pas suivre les instructions peut entraîner une défaillance de la protection fournie par l'équipement, ce qui peut entraîner des conséquences graves, comme des blessures ou des dommages à l'équipement.

3.2 Field channel LED indicator (Green)

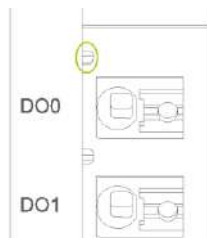

When the output signal of the output channel is valid, the corresponding field channel LED indicator is on.

3.3 Terminal definition

Terminal Number	Symbol	Description
1	DO0	Signal output
2	DO1	
3	DO2	
4	DO3	
5	DO4	
6	DO5	
7	DO6	
8	DO7	
9	24V	Power input (<i>Note1</i>)

Note: This power input port has two access methods depending on the load type.

WARNING

UNEXPECTED EQUIPMENT OPERATION

Calculate the maximum field power current consumption of a single module based on the actual field load. If the total field power current consumption of all I/O modules exceeds the power supply capacity of the field power supply, you must add an extra power expansion module. Otherwise, an output channel exception may occur.

Failure to follow instructions specified by the manufacturer may result in serious consequences such as death, personal injury, or damage to equipment since the protection provided by the equipment may be impaired.

AVERTISSEMENT

FONCTIONNEMENT INATTENDU DE L'EQUIPEMENT

Calculez la consommation maximale de courant de champ d'un seul module en fonction de la charge de champ réelle. Si la consommation totale de courant de champ de tous les modules d'E/S dépasse la capacité d'alimentation de l'alimentation de champ, vous devez ajouter un module d'extension de puissance supplémentaire. Dans le cas contraire, une exception de canal de sortie peut se produire.

Le fait de ne pas suivre les instructions peut entraîner une défaillance de la protection fournie par l'équipement, ce qui peut entraîner des conséquences graves, comme des blessures ou des dommages à l'équipement.

When connecting a cold-pressed terminal, the terminal must be terminated and checked in strict accordance with the corresponding termination specifications or requirements, and connect the cold-pressed terminal according to the corresponding node serial number. The conductor should use copper conductor and the conductor core should be larger than 0.2mm² and smaller than 1mm² (AWG18~AWG24). Cold-pressed terminal parameters are as follows:

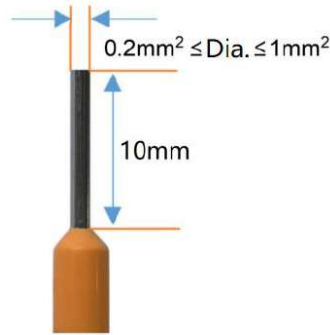

⚠ WARNING

UNEXPECTED EQUIPMENT OPERATION

Strip the length of the conductor insulation layer is greater than 10mm to ensure reliable signal connection.

The wire needs to use copper wire and the wire core is greater than or equal to 0.2mm² and less than or equal to 1mm² to ensure reliable signal connection.

When connecting a cold-press terminal, connect the cold-press terminal strictly in accordance with the corresponding termination specifications or requirements, and connect the cold-press terminal according to the corresponding node serial number.

Do not power on cold-press terminals until they are properly connected or fully locked.

Failure to follow instructions specified by the manufacturer may result in serious consequences such as death, personal injury, or damage to equipment since the protection provided by the equipment may be impaired.

⚠ AVERTISSEMENT

FONCTIONNEMENT INATTENDU DE L'ÉQUIPEMENT

Dépouillez la longueur de la couche isolante du fil plus de 10mm pour assurer la connexion fiable du signal.

Le conducteur doit utiliser le fil de cuivre et le noyau de fil est supérieur ou égal à 0,2 mm², inférieur ou égal à 1mm², afin d'assurer la connexion fiable du signal.

Lorsque les terminaux de presse à froid sont terminés, ils doivent être terminés et visualisés en stricte conformité avec les spécifications ou les exigences correspondantes et terminés selon le numéro de série de noeud correspondant.

Il est interdit d'activer les bornes à froid avant qu'elles ne soient correctement articulées ou complètement verrouillées.

Le fait de ne pas suivre les instructions peut entraîner une défaillance de la protection fournie par l'équipement, ce qui peut entraîner des conséquences graves, comme des blessures ou des dommages à l'équipement.

⚠ DANGER

FIRE DANGER

Use the correct wiring rules only for the maximum current capacity of the I/O channel and power supply.

Failure to follow instructions specified by the manufacturer may result in serious consequences such as death, personal injury, or damage to equipment since the protection provided by the equipment may be impaired.

 WARNING

UNEXPECTED EQUIPMENT OPERATION

Do not exceed any of the ratings specified in the environmental and electrical characteristics table.

Failure to follow instructions specified by the manufacturer may result in serious consequences such as death, personal injury, or damage to equipment since the protection provided by the equipment may be impaired.

 AVERTISSEMENT

FONCTIONNEMENT INATTENDU DE L'EQUIPEMENT

Ne dépassez aucune évaluation spécifiée dans le tableau de caractéristiques environnementales et électriques..

Le fait de ne pas suivre les instructions peut entraîner une défaillance de la protection fournie par l'équipement, ce qui peut entraîner des conséquences graves, comme des blessures ou des dommages à l'équipement.

4 Wiring

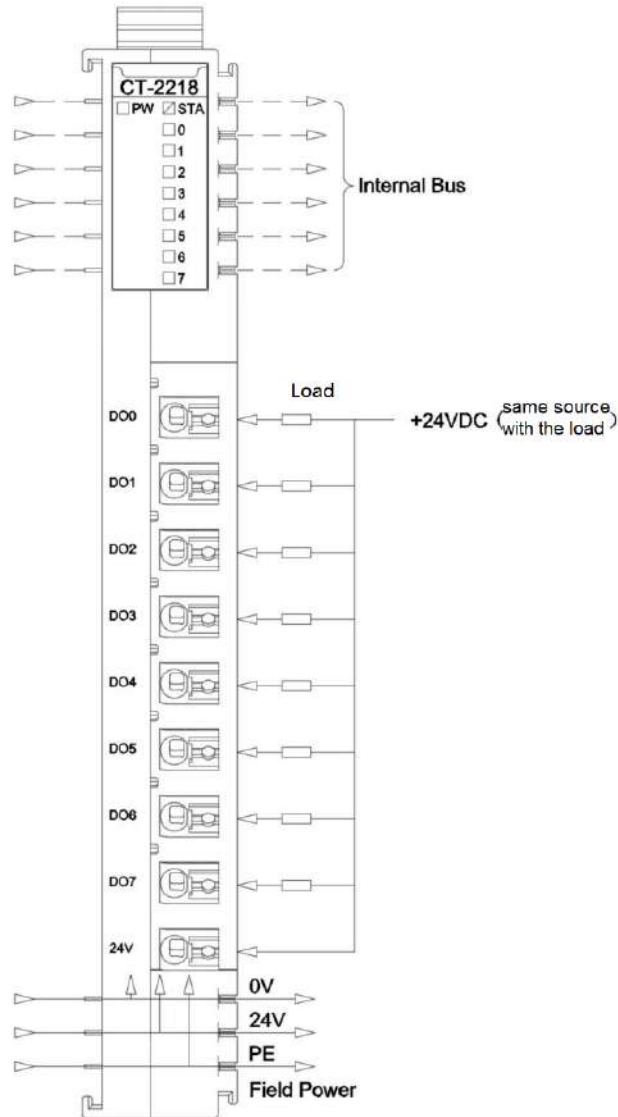

NOTICE

EQUIPMENT INOPERABLE

Do not crimp the spring terminal with more than the maximum pressure specified for the terminal. Otherwise, the resilience of the spring terminal may be damaged and the terminal rebound may be affected.

Do not press the spring terminal with a sharp tool when removing cable from the channel. Otherwise, the spring terminal will be damaged.

Failure to follow these instructions may result in equipment damage.

5 Process data definition

5.1 Module Process data

Output Data								
Bit No	Bit 7	Bit 6	Bit 5	Bit 4	Bit 3	Bit 2	Bit 1	Bit 0
Byte 0	DO Ch#7	DO Ch#6	DO Ch#5	DO Ch#4	DO Ch#3	DO Ch#2	DO Ch#1	DO Ch#0

Data description:

DO Ch#(0-7): When the bit is 1, the output signal of the corresponding channel is effective, the output is low level, and the output is invalid when it is 0.

0: The output signal is invalid

1: The output signal is valid

5.2 Sub-Module Process data

Input Data								
Bit No	Bit 7	Bit 6	Bit 5	Bit 4	Bit 3	Bit 2	Bit 1	Bit 0
Byte 0	Alarm (CH 7)	Alarm Ch#6	Alarm Ch#5	Alarm Ch#4	Alarm Ch#3	Alarm Ch#2	Alarm Ch#1	Alarm Ch#0

Alarm (CH 0-7): When the bit is 1, the corresponding channel is working abnormally, when it is 0, the channel is working normally.

0: The channel is working normally

1: The channel is working abnormally

6 Configuration parameters definition

6.1 Module Configuration Parameters

Configured Parameter								
Bit No	Bit 7	Bit 6	Bit 5	Bit 4	Bit 3	Bit 2	Bit 1	Bit 0
Byte 0	Fault Action for Output Ch#7	Fault Action for Output Ch#6	Fault Action for Output Ch#5	Fault Action for Output Ch#4	Fault Action for Output Ch#3	Fault Action for Output Ch#2	Fault Action for Output Ch#1	Fault Action for Output Ch#0
Byte 1	Fault Value for Output Ch#7	Fault Value for Output Ch#6	Fault Value for Output Ch#5	Fault Value for Output Ch#4	Fault Value for Output Ch#3	Fault Value for Output Ch#2	Fault Value for Output Ch#1	Fault Value for Output Ch#0

Data description:

Fault Action for Output Ch#(0-7): When IO module detects the internal bus communication is abnormal and enters offline mode, and output data will be processed in this mode. (Default: 0)

0: Hold Last Output State

1: Output Fault Value

Fault Value for Output Ch#(0-7): When the fault output mode is 1, this bit sets the fault output value, and when the internal bus of IO module is offline, this setting value will be output. (Default: 0)

0: Output low level.

1: Output high level.

6.2 Sub-Module Configuration Parameters

Configure Parameter								
Bit No	Bit 7	Bit 6	Bit 5	Bit 4	Bit 3	Bit 2	Bit 1	Bit 0
Byte 0	Handle Mode (CH 7)	Handle Mode (CH 6)	Handle Mode (CH 5)	Handle Mode (CH 4)	Handle Mode (CH 3)	Handle Mode (CH 2)	Handle Mode (CH 1)	Handle Mode (CH 0)
Byte 1	Output Turn off Time(s)							
Byte 2	Reserved							

Handle Mode (CH 0-7): When the channel is detected to be abnormal condition (short circuit or overcurrent), the channel will immediately shut off.

Output Turn off Time(s): When the channel is detected to be abnormal condition (short circuit or overcurrent), the time for the channel to be turned off can be set 16-bit unsigned data, the range is “1-255”, (Default: 2s).

A Dimension drawing

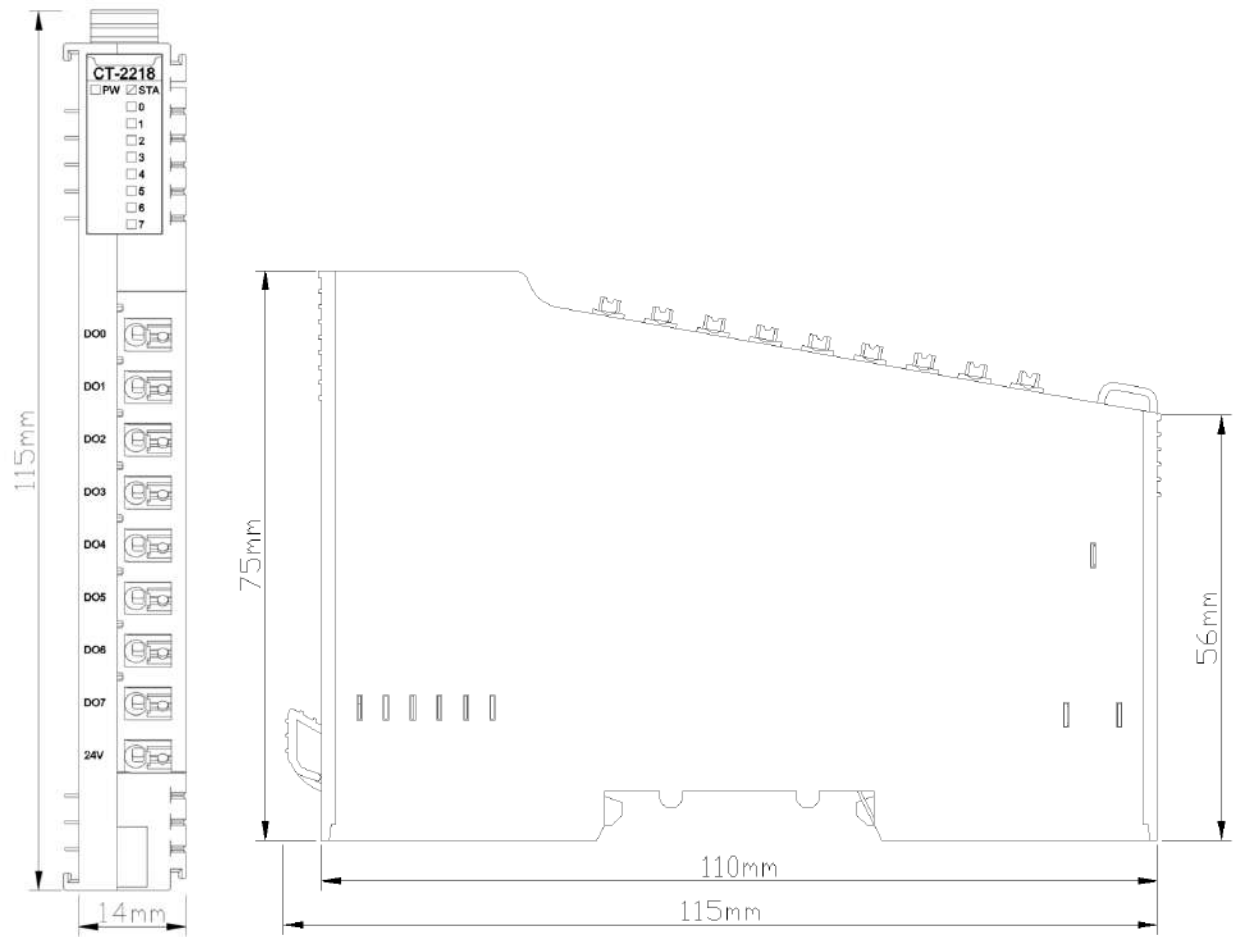

CT-2228 8 channels digital output/24VDC/ PNP

1 Module features

- ◆ The module supports 8-channel digital output, the output voltage is 24VDC and the output high level is valid.
- ◆ The module could drive field equipment (relay, solenoid valve, etc.)
- ◆ The module internal bus and field output are isolated by optocoupler
- ◆ The module carries with 8 digital output channel LED indicator
- ◆ The module has the functions of thermal shutdown and overcurrent protection
- ◆ The module supports short circuit protection and overload protection

2 Technical Parameters

General Parameters	
Power Consumption	Max.80mA@5.0VDC
Isolation	I/O to internal bus: opto-couple isolation (3KVrms)
Field Power	Nominal:24VDC, Range:20.4-28.8VDC
Wiring	Max.: AWG 18 Min.: AWG 24
Installation	35mm DIN-Rail
Size	115*14*75mm
Weight	65g
Vibration Resistance	Comply with IEC 61131-2 and EC 60068-2-6
Impact resistance	Comply with IEC 61131-2 and IEC 60068-2-27
EMC Performance	Comply with IEC 61131-2 and IEC 61000-4
Environment Specification	
Operating Temperature of Horizontal Installation	-35°C~70°C
Operating Temperature of Vertical Installation	-35°C~60°C
Relative Humidity	< 95%RH (No Condensation)
Storage Temperature	-40°C~85°C
Storage Humidity	< 95%RH (No Condensation)
Manufacturing Test Temperature	-40°C~75°C
Ingress Protection Rating	IP20
Output Parameters	
Channel Number	8 Channels
LED Indicator	8 Channels output LED Indicator
Rated Current	Typical value: 500mA
Leak Current	Max. value: 100uA
Output Impedance	<280mΩ
Output Delay	OFF to ON:Max.100us ON to OFF:Max.150us
Protection Function	Over temperature turn-off: typical 135°C Overcurrent protection: typical value 1.1A
Load type	General use and Resistive, Pilot Duty

 **WARNING**

UNEXPECTED EQUIPMENT OPERATION

Do not exceed any of the ratings specified in the environmental and electrical characteristics table.

Failure to follow instructions specified by the manufacturer may result in serious consequences such as death, personal injury, or damage to equipment since the protection provided by the equipment may be impaired.

 **AVERTISSEMENT**

FONCTIONNEMENT INATTENDU DE L'EQUIPEMENT

Ne dépassez aucune évaluation spécifiée dans le tableau de caractéristiques environnementales et électriques..

Le fait de ne pas suivre les instructions peut entraîner une défaillance de la protection fournie par l'équipement, ce qui peut entraîner des conséquences graves, comme des blessures ou des dommages à l'équipement.

3 Hardware Interface

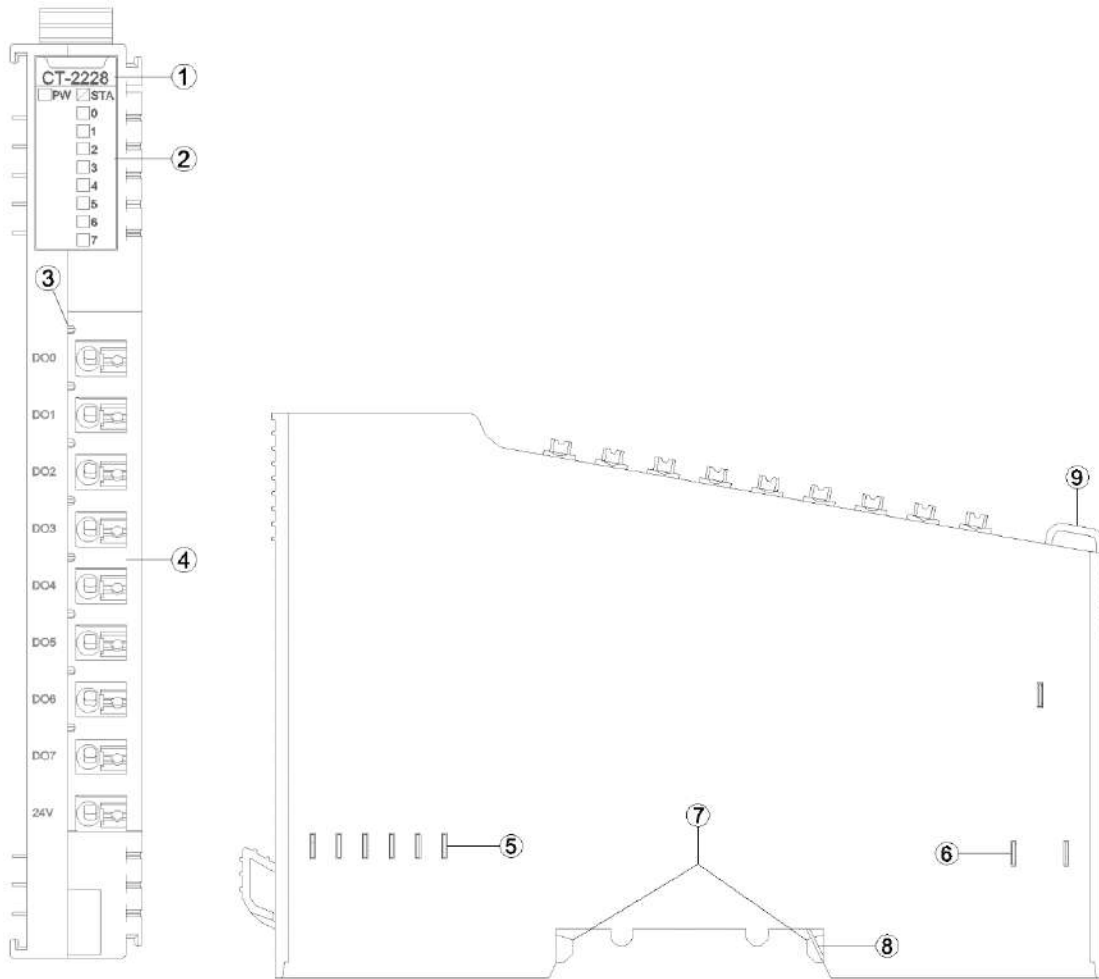

- ① Module Type
- ② State indicator
- ③ Channel indicator
- ④ Wiring Terminal and identification
- ⑤ Internal Bus
- ⑥ Field Power
- ⑦ Buckle
- ⑧ Grounding Spring Sheet
- ⑨ Fixed Wiring Harness

3.1 LED indicator definition

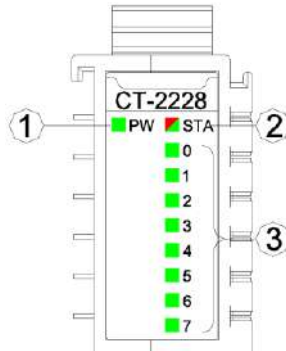

- ① Power LED indicator (green)
- ② Module State LED indicator (red/green)
- ③ Output channel LED indicator (green)

PW Power State (GREEN)	Definition
ON	Internal bus Power Normal
OFF	Internal bus Power Failure
STA Module State (RED/GREEN)	Definition
Green slow flash (2.5Hz)	Module internal bus is not started
Red slow flash (2.5Hz)	Module internal bus offline
ON (GREEN)	Operation normal
Flash(2.5Hz) (RED/GREEN)	Upgrading mode
Flash(10Hz) (RED/GREEN)	Firmware Update
Double Flash (RED)	Module Exception has been soft-restarted
0-7 channel LED indicator (GREEN)	Definition
ON	Output signal valid
OFF	Output signal invalid

! WARNING

UNEXPECTED EQUIPMENT OPERATION

By viewing the PW indicator, could determine the power supply status of a module. If the PW is steady green, the power supply is normal. Otherwise, the module cannot work properly.

When the module is initially powered on, there will be 3S for the backplane bus connection. After the backplane bus is initialized, STA is in the green steady state. If STA is in the green blinking state, it indicates that the backplane bus has not been initialized, and it needs to be powered off and restarted for re-initialization.

STA abnormal working state occurs during the normal operation of the module, please check the firmware version information of all modules, and consult ODOT technical support for details.

If a module is upgraded, check that all modules are in the normal state after the upgrade. Otherwise, an exception may occur.

Failure to follow instructions specified by the manufacturer may result in serious consequences such as death, personal injury, or damage to equipment since the protection

provided by the equipment may be impaired.

! AVERTISSEMENT

FONCTIONNEMENT INATTENDU DE L'EQUIPEMENT

En regardant l'état de l'indicateur de PW, jugez l'état d'alimentation du module. Le feu vert PW reste allumé et l'alimentation est normale. Autrement, le module ne fonctionnera pas correctement.

Lorsque le module est alimenté initialement, il y aura 3S pour la connexion de bus de backboard. STA est un état vert permanent après l'initialisation du bus de backboard. Si STA est en état de clignotement vert, cela signifie que l'initialisation du bus de backboard n'est pas passée et doit être redémarrée hors tension et réinitialisée.

L'état de fonctionnement anormal de STA se produit pendant le fonctionnement normal du module, veuillez vérifier les informations de version du firmware de tous les modules, et consulter le support technique ODOT pour plus de détails.

Si le module a une opération de mise à niveau, après l'achèvement de la mise à niveau, le besoin de vérifier que tous les modules sont dans l'état normal avant de courir, sinon il conduira à une exception.

Le fait de ne pas suivre les instructions peut entraîner une défaillance de la protection fournie par l'équipement, ce qui peut entraîner des conséquences graves, comme des blessures ou des dommages à l'équipement.

3.2 Field channel LED indicator (Green)

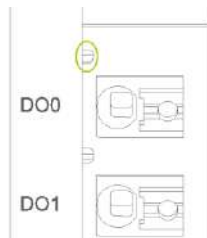

When the output signal of the output channel is valid, the corresponding field channel LED indicator is on.

3.3 Terminal definition

Terminal Number	Symbol	Description
1	DO0	Signal output
2	DO1	
3	DO2	
4	DO3	
5	DO4	
6	DO5	
7	DO6	
8	DO7	
9	24V	Power input (<i>Note1</i>)

Note 1: When the red LED indicator beside the 24V terminals lights up, this is indicating that the module output has passed the field bus, so the 24V terminals could be disconnected. The max. output current of each channel is 500mA, and the max. sum of the current of all the output channels is 4A. When the total current exceeds 2A, and it is suggested to connect the power in the 24V terminal at the same time to avoid the on-site power current exceeding its limit.

When the red LED indicator beside the 24V terminal goes off, it means that the module output is not powered. In this case, the power supply needs to be connected in the 24V terminal. At this point, the max. output current of each channel is 500mA, and the sum of all output channel currents is 4A.

WARNING

UNEXPECTED EQUIPMENT OPERATION

Calculate the maximum field power current consumption of a single module based on the actual field load. If the total field power current consumption of all I/O modules exceeds the power supply capacity of the field power supply, you must add an extra power expansion module. Otherwise, an output channel exception may occur.

Failure to follow instructions specified by the manufacturer may result in serious consequences such as death, personal injury, or damage to equipment since the protection provided by the equipment may be impaired.

AVERTISSEMENT

FONCTIONNEMENT INATTENDU DE L'EQUIPEMENT

Calculez la consommation maximale de courant de champ d'un seul module en fonction de la charge de champ réelle. Si la consommation totale de courant de champ de tous les modules d'E/S dépasse la capacité d'alimentation de l'alimentation de champ, vous devez ajouter un module d'extension de puissance supplémentaire. Dans le cas contraire, une exception de canal de sortie peut se produire.

Le fait de ne pas suivre les instructions peut entraîner une défaillance de la protection fournie

par l'équipement, ce qui peut entraîner des conséquences graves, comme des blessures ou des dommages à l'équipement.

When connecting a cold-pressed terminal, the terminal must be terminated and checked in strict accordance with the corresponding termination specifications or requirements, and connect the cold-pressed terminal according to the corresponding node serial number. The conductor should use copper conductor and the conductor core should be larger than 0.2mm^2 and smaller than 1mm^2 (AWG18~AWG24). Cold-pressed terminal parameters are as follows:

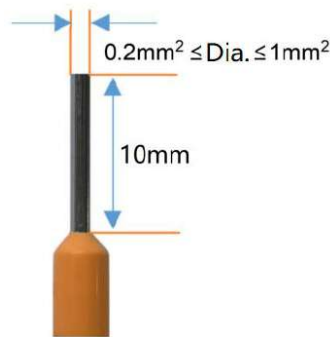

! WARNING

UNEXPECTED EQUIPMENT OPERATION

Strip the length of the conductor insulation layer is greater than 10mm to ensure reliable signal connection.

The wire needs to use copper wire and the wire core is greater than or equal to 0.2mm^2 and less than or equal to 1mm^2 to ensure reliable signal connection.

When connecting a cold-press terminal, connect the cold-press terminal strictly in accordance with the corresponding termination specifications or requirements, and connect the cold-press terminal according to the corresponding node serial number.

Do not power on cold-press terminals until they are properly connected or fully locked.

Failure to follow instructions specified by the manufacturer may result in serious consequences such as death, personal injury, or damage to equipment since the protection provided by the equipment may be impaired.

! AVERTISSEMENT

FONCTIONNEMENT INATTENDU DE L'EQUIPEMENT

Dépouillez la longueur de la couche isolante du fil plus de 10mm pour assurer la connexion fiable du signal.

Le conducteur doit utiliser le fil de cuivre et le noyau de fil est supérieur ou égal à $0,2\text{ mm}^2$, inférieur ou égal à 1mm^2 , afin d'assurer la connexion fiable du signal.

Lorsque les terminaux de presse à froid sont terminés, ils doivent être terminés et visualisés en stricte conformité avec les spécifications ou les exigences correspondantes et terminés selon le

numéro de série de noeud correspondant.

Il est interdit d'activer les bornes à froid avant qu'elles ne soient correctement articulées ou complètement verrouillées.

Le fait de ne pas suivre les instructions peut entraîner une défaillance de la protection fournie par l'équipement, ce qui peut entraîner des conséquences graves, comme des blessures ou des dommages à l'équipement.

DANGER

FIRE DANGER

Use the correct wiring rules only for the maximum current capacity of the I/O channel and power supply.

Failure to follow instructions specified by the manufacturer may result in serious consequences such as death, personal injury, or damage to equipment since the protection provided by the equipment may be impaired.

WARNING

UNEXPECTED EQUIPMENT OPERATION

Do not exceed any of the ratings specified in the environmental and electrical characteristics table.

Failure to follow instructions specified by the manufacturer may result in serious consequences such as death, personal injury, or damage to equipment since the protection provided by the equipment may be impaired.

AVERTISSEMENT

FONCTIONNEMENT INATTENDU DE L'EQUIPEMENT

Ne dépassez aucune évaluation spécifiée dans le tableau de caractéristiques environnementales et électriques..

Le fait de ne pas suivre les instructions peut entraîner une défaillance de la protection fournie par l'équipement, ce qui peut entraîner des conséquences graves, comme des blessures ou des dommages à l'équipement.

4 Wiring

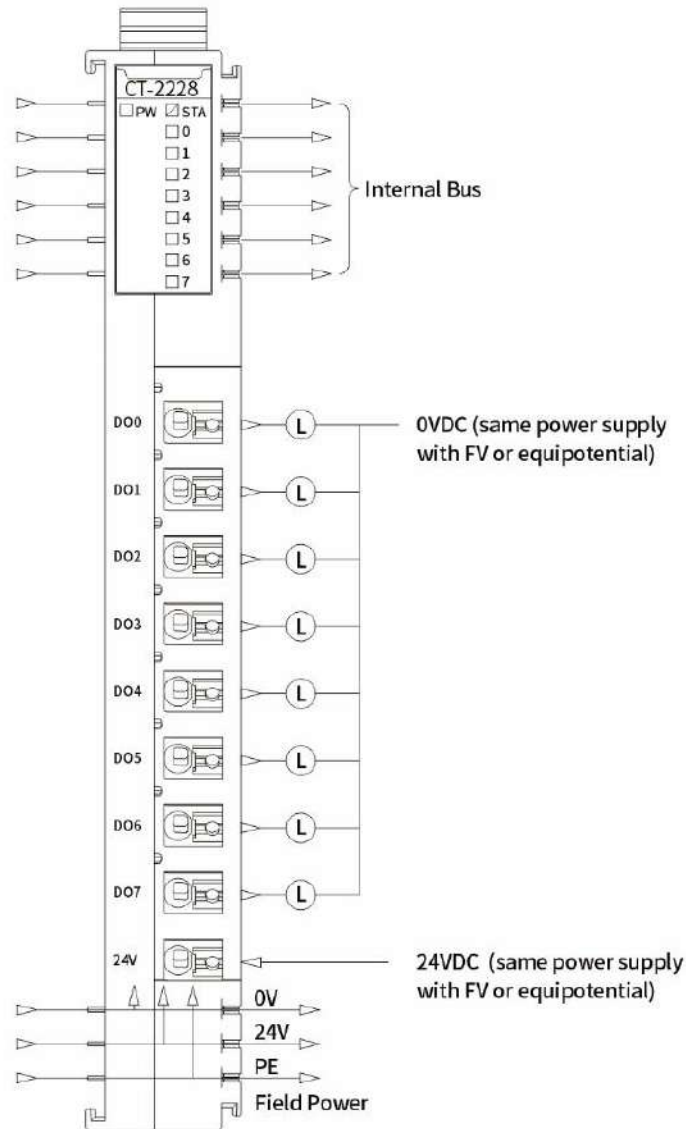

NOTICE

EQUIPMENT INOPERABLE

Do not crimp the spring terminal with more than the maximum pressure specified for the terminal. Otherwise, the resilience of the spring terminal may be damaged and the terminal rebound may be affected.

Do not press the spring terminal with a sharp tool when removing cable from the channel. Otherwise, the spring terminal will be damaged.

Failure to follow these instructions may result in equipment damage.

5 Process data definition

Output Data								
Bit No	Bit 7	Bit 6	Bit 5	Bit 4	Bit 3	Bit 2	Bit 1	Bit 0
Byte 0	DO Ch#7	DO Ch#6	DO Ch#5	DO Ch#4	DO Ch#3	DO Ch#2	DO Ch#1	DO Ch#0

Data description:

DO Ch#(0-7): When the bit is 1, the output signal of the corresponding channel is effective, the output is high level, and the output is invalid when it is 0.

0: The output signal is invalid

1: The output signal is valid

6 Configuration parameters definition

Configured Parameter								
Bit No	Bit 7	Bit 6	Bit 5	Bit 4	Bit 3	Bit 2	Bit 1	Bit 0
Byte 0	Fault Action for Output Ch#7	Fault Action for Output Ch#6	Fault Action for Output Ch#5	Fault Action for Output Ch#4	Fault Action for Output Ch#3	Fault Action for Output Ch#2	Fault Action for Output Ch#1	Fault Action for Output Ch#0
Byte 1	Fault Value for Output Ch#7	Fault Value for Output Ch#6	Fault Value for Output Ch#5	Fault Value for Output Ch#4	Fault Value for Output Ch#3	Fault Value for Output Ch#2	Fault Value for Output Ch#1	Fault Value for Output Ch#0

Data description:

Fault Action for Output Ch#(0-7): When IO module detects the internal bus communication is abnormal and enters offline mode, and output data will be processed in this mode. (Default: 0)

0: Hold Last Output State

1: Output Fault Value

Fault Value for Output Ch#(0-7): When the fault output mode is 1, this bit sets the fault output value, and when the internal bus of IO module is offline, this setting value will be output. (Default: 0)

0: Output low level.

1: Output high level.

A Dimension drawing

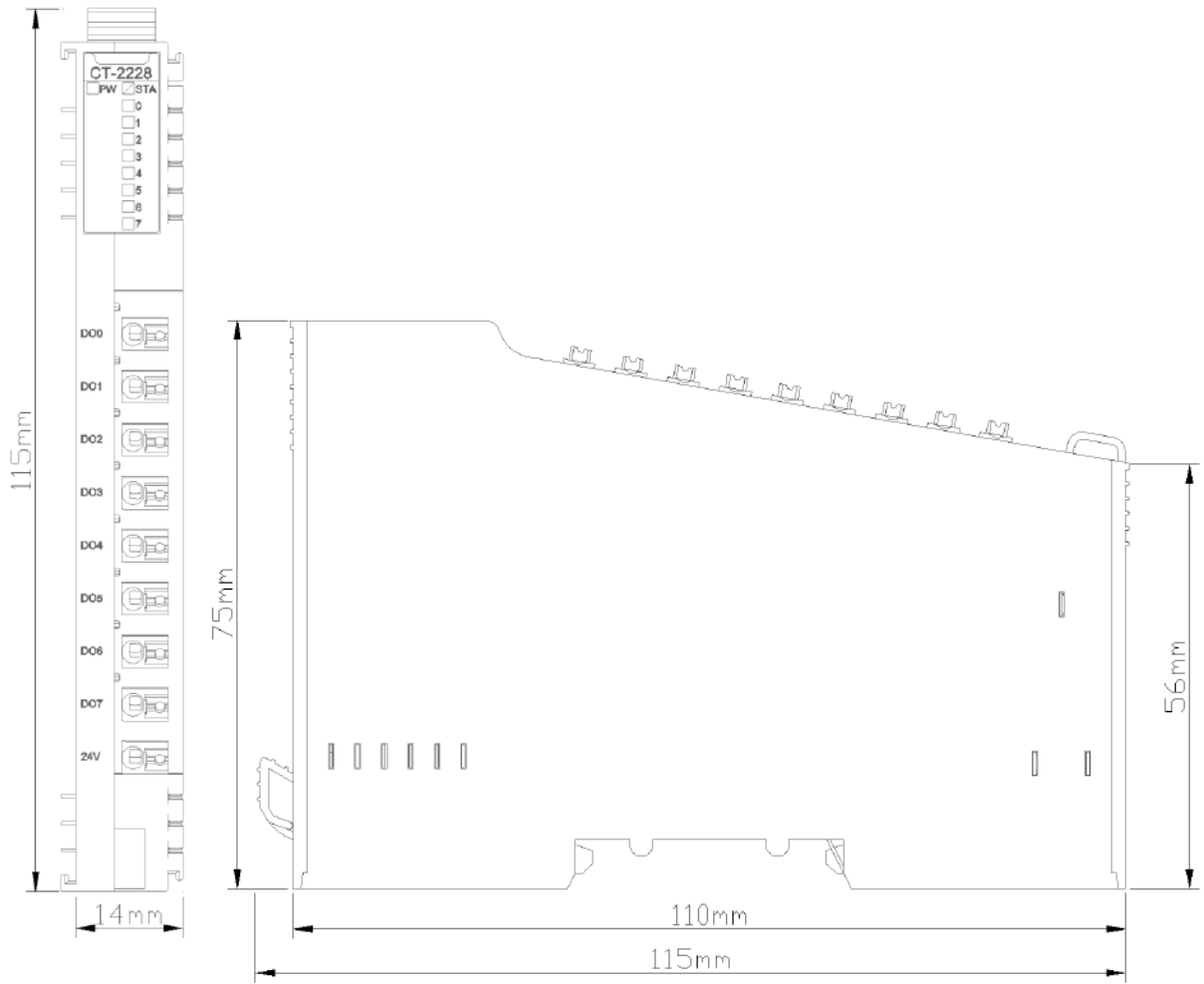

CT-222F 16 channels digital output/24VDC/PNP

1 Module features

- ◆ The module supports 16 channels digital output, the output voltage is 24VDC and the output high level is valid.
- ◆ Module can drive field equipment. (relay, solenoid valve, etc.)
- ◆ The internal bus of the module and field output are using opto-coupler.
- ◆ The module carries 16 digital output channel LED indicator light.
- ◆ The module has the functions of thermal shutdown and overcurrent protection.
- ◆ The module supports short circuit protection and overload protection.

2 Technical parameters

General Parameters	
Power	Max.175mA@5.0VDC
Isolation	I/O to internal bus: opto-couple isolation (3KVrms)
Field Power	Nominal:24VDC, Range:20.4-28.8VDC
Wiring	Max.: AWG 18 Min.: AWG 24
Installation	35mm DIN-Rail
Size	115*14*75mm
Weight	65g
Vibration Resistance	Comply with IEC 61131-2 and EC 60068-2-6
Impact resistance	Comply with IEC 61131-2 and IEC 60068-2-27
EMC Performance	Comply with IEC 61131-2 and IEC 61000-4
Environment Specification	
Operating Temperature of Horizontal Installation	-35°C~70°C
Operating Temperature of Vertical Installation	-35°C~60°C
Relative Humidity	< 95%RH (No Condensation)
Storage Temperature	-40°C~85°C
Storage Humidity	< 95%RH (No Condensation)
Manufacturing Test Temperature	-40°C~75°C
Ingress Protection Rating	IP20
Output Parameters	
Channel Number	16 channel source type output
LED Indicator	16 channel output LED indicator
Rated Current	Typical value: 500mA
Leakage Current	Max: 10uA
Output Impedance	<200mΩ
Output Delay	OFF to ON: Max.100us ON to OFF: Max.150us
Protection	Overtemperature shutdown: typical value is 135°C Overcurrent protection: typical value 1.1A Short circuit protection support
Load type	General use and Resistive, Pilot Duty

 **WARNING**

UNEXPECTED EQUIPMENT OPERATION

Do not exceed any of the ratings specified in the environmental and electrical characteristics table.

Failure to follow instructions specified by the manufacturer may result in serious consequences such as death, personal injury, or damage to equipment since the protection provided by the equipment may be impaired.

 **AVERTISSEMENT**

FONCTIONNEMENT INATTENDU DE L'EQUIPEMENT

Ne dépassez aucune évaluation spécifiée dans le tableau de caractéristiques environnementales et électriques..

Le fait de ne pas suivre les instructions peut entraîner une défaillance de la protection fournie par l'équipement, ce qui peut entraîner des conséquences graves, comme des blessures ou des dommages à l'équipement.

3 Hardware interfaces

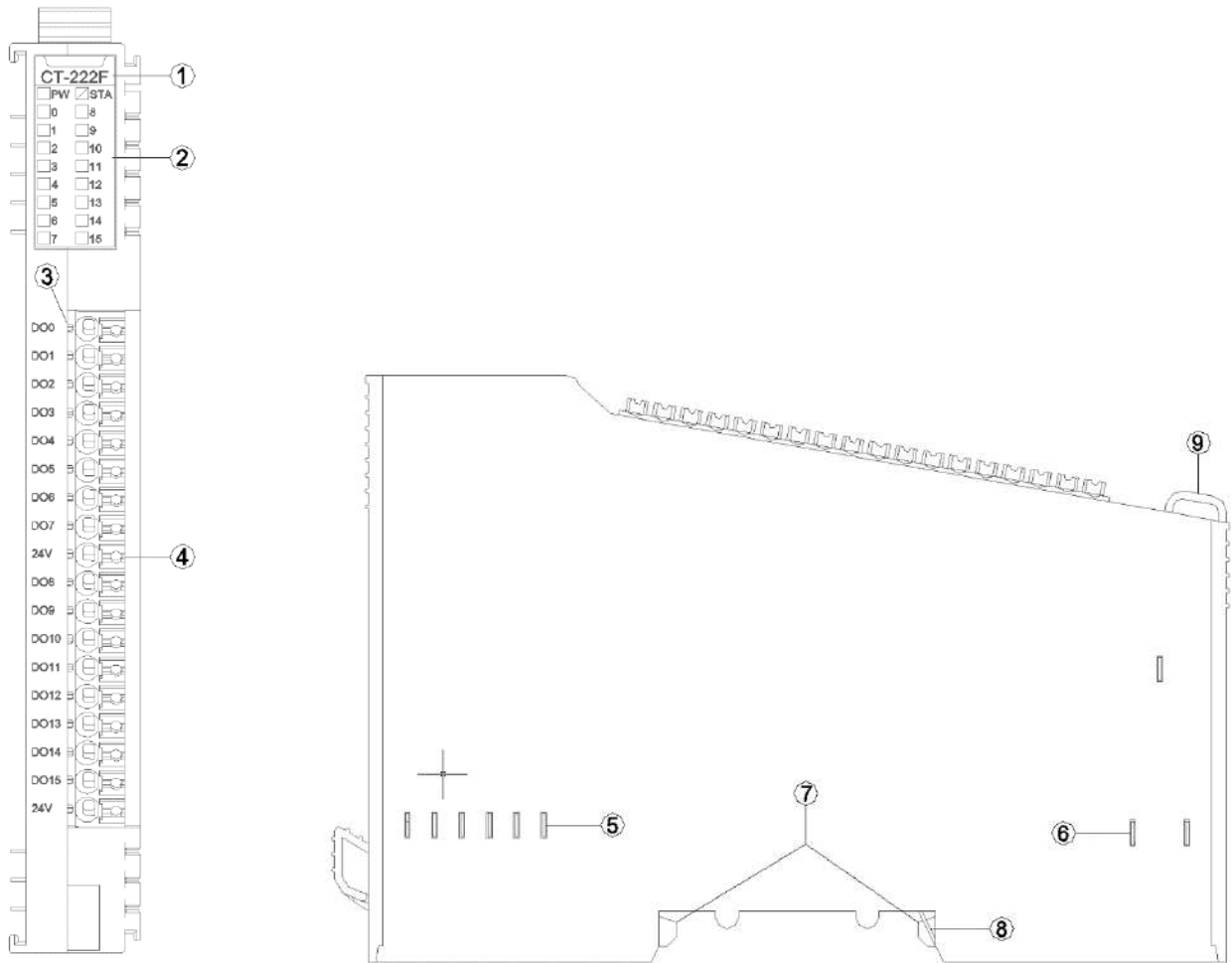

- ① Module Type
- ② State indicator
- ③ Channel indicator
- ④ Wiring Terminal and identification
- ⑤ Internal Bus
- ⑥ Field Power
- ⑦ Buckle
- ⑧ Grounding Spring Sheet
- ⑨ Fixed Wiring Harness

3.1 LED indicator definition

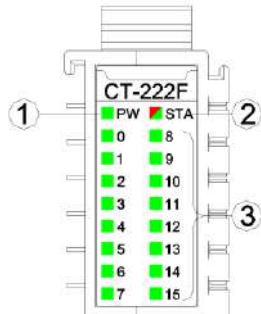

- ① Power LED indicator (green)
- ② Module State indicator LED (red/green)
- ③ Output channel indicator LED (green)

PW Power State	Definition
ON	Internal bus power supply normal
OFF	Internal bus power supply failure
STA Module State (RED/GREEN)	Definition
Green slow flash (2.5 Hz)	Module internal bus is not started
Red slow flash (2.5 Hz)	Module internal bus offline
ON (GREEN)	Operation normal
Flash (2.5 Hz) (RED/GREEN)	updating mode
Flash (10 Hz) (RED/GREEN)	firmware update
Double Flash (RED)	Module exception has been soft-restarted
0-15 channel indicator LED	Definition
ON	Output signal valid
OFF	Output signal invalid

! WARNING

UNEXPECTED EQUIPMENT OPERATION

By viewing the PW indicator, could determine the power supply status of a module. If the PW is steady green, the power supply is normal. Otherwise, the module cannot work properly.

When the module is initially powered on, there will be 3S for the backplane bus connection. After the backplane bus is initialized, STA is in the green steady state. If STA is in the green blinking state, it indicates that the backplane bus has not been initialized, and it needs to be powered off and restarted for re-initialization.

STA abnormal working state occurs during the normal operation of the module, please check the firmware version information of all modules, and consult ODOT technical support for details.

If a module is upgraded, check that all modules are in the normal state after the upgrade. Otherwise, an exception may occur.

Failure to follow instructions specified by the manufacturer may result in serious consequences such as death, personal injury, or damage to equipment since the protection provided by the equipment may be impaired.

AVERTISSEMENT

FONCTIONNEMENT INATTENDU DE L'EQUIPEMENT

En regardant l'état de l'indicateur de PW, jugez l'état d'alimentation du module. Le feu vert PW reste allumé et l'alimentation est normale. Autrement, le module ne fonctionnera pas correctement.

Lorsque le module est alimenté initialement, il y aura 3S pour la connexion de bus de backboard. STA est un état vert permanent après l'initialisation du bus de backboard. Si STA est en état de clignotement vert, cela signifie que l'initialisation du bus de backboard n'est pas passée et doit être redémarrée hors tension et réinitialisée.

L'état de fonctionnement anormal de STA se produit pendant le fonctionnement normal du module, veuillez vérifier les informations de version du firmware de tous les modules, et consulter le support technique ODOT pour plus de détails.

Si le module a une opération de mise à niveau, après l'achèvement de la mise à niveau, le besoin de vérifier que tous les modules sont dans l'état normal avant de courir, sinon il conduira à une exception.

Le fait de ne pas suivre les instructions peut entraîner une défaillance de la protection fournie par l'équipement, ce qui peut entraîner des conséquences graves, comme des blessures ou des dommages à l'équipement.

3.2 Field channel LED indicator (Green)

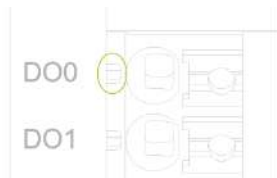

When output signal of output channel is valid, the corresponding field channel LED indicator is on.

3.3 Terminal definition

Terminal Number	Symbol	The Description
1	DO0	Signal output
2	DO1	
3	DO2	
4	DO3	
5	DO4	
6	DO5	
7	DO6	
8	DO7	
9	24V	Power input (<i>note1</i>)
10	DO8	Signal output
11	DO9	
12	DO10	
13	DO11	
14	DO12	
15	DO13	
16	DO14	
17	DO15	
18	24V	Power input(<i>note1</i>)

Note 1: when the red LED indicator beside the 24V wiring terminal is on, it indicates that the fieldbus is powered on, then the maximum output current of each channel is 500mA, and the maximum sum of all output channel currents is 4A.

When the 24VDC power is supplied to the 24V wiring terminal separately, the maximum sum of all the output channel currents is 8A (Regardless of whether the fieldbus is powered or not, 24V wiring terminals can be connected to 24VDC power supply).

WARNING

UNEXPECTED EQUIPMENT OPERATION

Calculate the maximum field power current consumption of a single module based on the actual field load. If the total field power current consumption of all I/O modules exceeds the power supply capacity of the field power supply, you must add an extra power expansion module. Otherwise, an output channel exception may occur.

Failure to follow instructions specified by the manufacturer may result in serious consequences such as death, personal injury, or damage to equipment since the protection provided by the equipment may be impaired.

AVERTISSEMENT

FONCTIONNEMENT INATTENDU DE L'EQUIPEMENT

Calculez la consommation maximale de courant de champ d'un seul module en fonction de la charge de champ réelle. Si la consommation totale de courant de champ de tous les modules d'E/S dépasse la capacité d'alimentation de l'alimentation de champ, vous devez ajouter un module d'extension de puissance supplémentaire. Dans le cas contraire, une exception de canal de sortie peut se produire.

Le fait de ne pas suivre les instructions peut entraîner une défaillance de la protection fournie par l'équipement, ce qui peut entraîner des conséquences graves, comme des blessures ou des dommages à l'équipement.

When connecting a cold-pressed terminal, the terminal must be terminated and checked in strict accordance with the corresponding termination specifications or requirements, and connect the cold-pressed terminal according to the corresponding node serial number. The conductor should use copper conductor and the conductor core should be larger than 0.2mm^2 and smaller than 1mm^2 (AWG18~AWG24). Cold-pressed terminal parameters are as follows:



⚠ WARNING

UNEXPECTED EQUIPMENT OPERATION

Strip the length of the conductor insulation layer is greater than 10mm to ensure reliable signal connection.

The wire needs to use copper wire and the wire core is greater than or equal to 0.2mm^2 and less than or equal to 1mm^2 to ensure reliable signal connection.

When connecting a cold-press terminal, connect the cold-press terminal strictly in accordance with the corresponding termination specifications or requirements, and connect the cold-press terminal according to the corresponding node serial number.

Do not power on cold-press terminals until they are properly connected or fully locked.

Failure to follow instructions specified by the manufacturer may result in serious consequences such as death, personal injury, or damage to equipment since the protection provided by the equipment may be impaired.

⚠ AVERTISSEMENT

FONCTIONNEMENT INATTENDU DE L'EQUIPEMENT

Dépouillez la longueur de la couche isolante du fil plus de 10mm pour assurer la connexion fiable

du signal.

Le conducteur doit utiliser le fil de cuivre et le noyau de fil est supérieur ou égal à 0,2 mm², inférieur ou égal à 1mm², afin d'assurer la connexion fiable du signal.

Lorsque les terminaux de presse à froid sont terminés, ils doivent être terminés et visualisés en stricte conformité avec les spécifications ou les exigences correspondantes et terminés selon le numéro de série de noeud correspondant.

Il est interdit d'activer les bornes à froid avant qu'elles ne soient correctement articulées ou complètement verrouillées.

Le fait de ne pas suivre les instructions peut entraîner une défaillance de la protection fournie par l'équipement, ce qui peut entraîner des conséquences graves, comme des blessures ou des dommages à l'équipement.

DANGER

FIRE DANGER

Use the correct wiring rules only for the maximum current capacity of the I/O channel and power supply.

Failure to follow instructions specified by the manufacturer may result in serious consequences such as death, personal injury, or damage to equipment since the protection provided by the equipment may be impaired.

WARNING

UNEXPECTED EQUIPMENT OPERATION

Do not exceed any of the ratings specified in the environmental and electrical characteristics table.

Failure to follow instructions specified by the manufacturer may result in serious consequences such as death, personal injury, or damage to equipment since the protection provided by the equipment may be impaired.

AVERTISSEMENT

FONCTIONNEMENT INATTENDU DE L'EQUIPEMENT

Ne dépassez aucune évaluation spécifiée dans le tableau de caractéristiques environnementales et électriques..

Le fait de ne pas suivre les instructions peut entraîner une défaillance de la protection fournie par l'équipement, ce qui peut entraîner des conséquences graves, comme des blessures ou des dommages à l'équipement.

4 Wiring

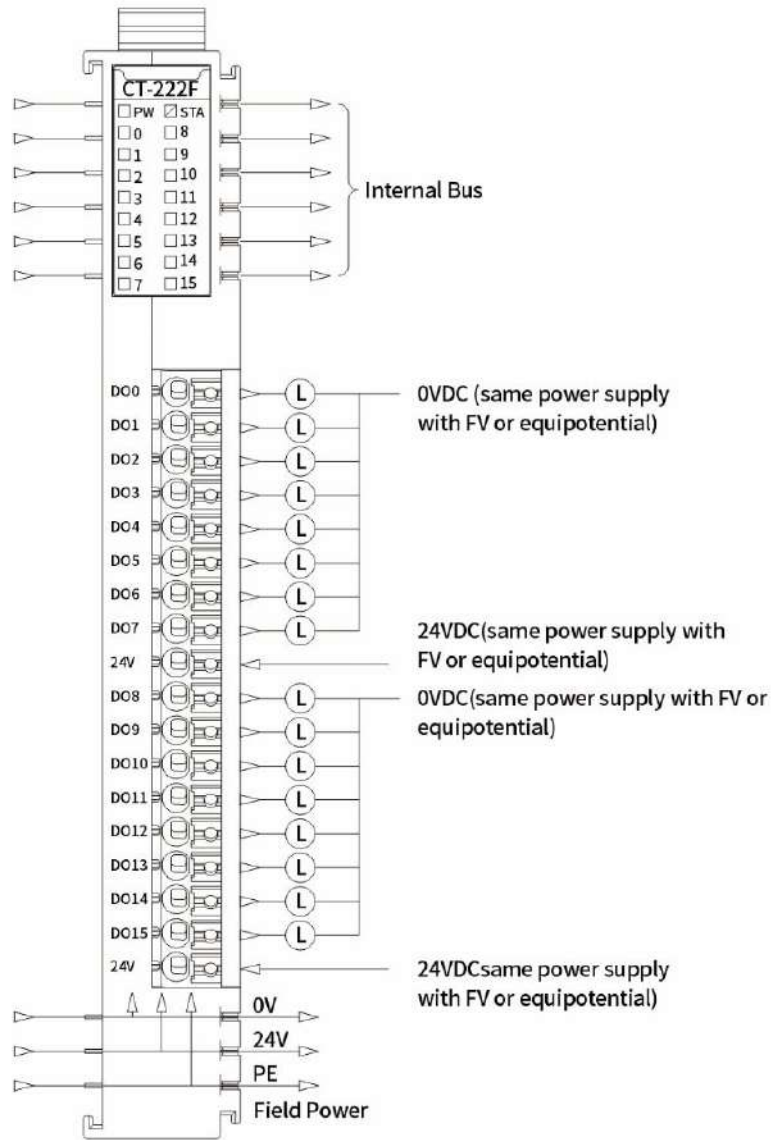

NOTICE

EQUIPMENT INOPERABLE

Do not crimp the spring terminal with more than the maximum pressure specified for the terminal. Otherwise, the resilience of the spring terminal may be damaged and the terminal rebound may be affected.

Do not press the spring terminal with a sharp tool when removing cable from the channel. Otherwise, the spring terminal will be damaged.

Failure to follow these instructions may result in equipment damage.

5 Process data definition

Output data								
Bit No	Bit 7	Bit 6	Bit 5	Bit 4	Bit 3	Bit 2	Bit 1	Bit 0
Byte 0	DO Ch#7	DO Ch#6	DO Ch#5	DO Ch#4	DO Ch#3	DO Ch#2	DO Ch#1	DO Ch#0
Byte 1	DO Ch#15	DO Ch#14	DO Ch#13	DO Ch#12	DO Ch#11	DO Ch#10	DO Ch#9	DO Ch#8

Data description:

DO Ch#(0-15): when this bit is 1, the corresponding channel output signal is valid, the output is high level, and the output is invalid when it is 0.

0: Output signal is invalid

1: Output signal is valid

6 Configuration parameter definitions

Configuration parameters								
Bit No	Bit 7	Bit 6	Bit 5	Bit 4	Bit 3	Bit 2	Bit 1	Bit 0
Byte 0	Fault Action for Output Ch#7	Fault Action for Output Ch#6	Fault Action for Output Ch#5	Fault Action for Output Ch#4	Fault Action for Output Ch#3	Fault Action for Output Ch#2	Fault Action for Output Ch#1	Fault Action for Output Ch#0
Byte 1	Fault Action for Output Ch#15	Fault Action for Output Ch#14	Fault Action for Output Ch#13	Fault Action for Output Ch#12	Fault Action for Output Ch#11	Fault Action for Output Ch#10	Fault Action for Output Ch#9	Fault Action for Output Ch#8
Byte 2	Fault Value for Output Ch#7	Fault Value for Output Ch#6	Fault Value for Output Ch#5	Fault Value for Output Ch#4	Fault Value for Output Ch#3	Fault Value for Output Ch#2	Fault Value for Output Ch#1	Fault Value for Output Ch#0
Byte 3	Fault Value for Output Ch#15	Fault Value for Output Ch#14	Fault Value for Output Ch#13	Fault Value for Output Ch#12	Fault Value for Output Ch#11	Fault Value for Output Ch#10	Fault Value for Output Ch#9	Fault Value for Output Ch#8

Data description:

Fault Action for Output Ch#(0-15): Fault Output mode. When the IO module detects an internal bus exception and fails to communicate with the adapter. And the module will turn to offline mode, so the output data is processed in this way. (Default: 0)

0: keep the last time output State.

1: output fault value.

Fault Value for Output Ch#(0-15): when the Fault Output mode is 1, this bit sets the Fault Output Value, and this setting value will be outputted when the internal bus of IO module is offline. (default: 0)

0: Output low level.

1: Output high level.

A Dimension drawing

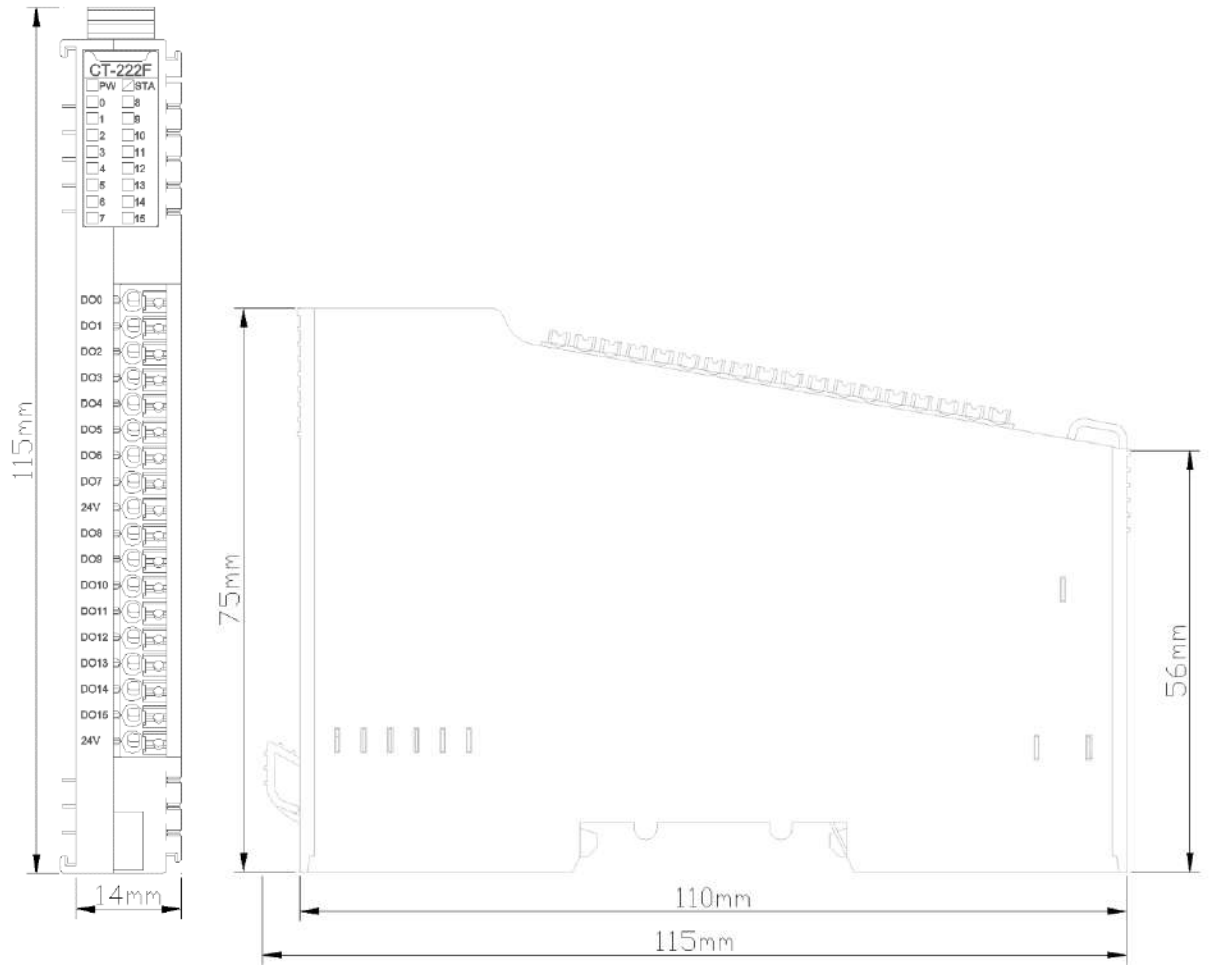

CT-222F-NP 16 channels digital output/24VDC/PNP

1 Module features

- ◆ The module supports 16 channels digital output, the output voltage is 24VDC and the output high level is valid.
- ◆ Module can drive field equipment. (relay, solenoid valve, etc.)
- ◆ The internal bus of the module and field output are using opto-coupler.
- ◆ The module carries 16 digital output channel LED indicator light.
- ◆ The module has the functions of thermal shutdown and overcurrent protection.
- ◆ The module supports short circuit protection and overload protection.
- ◆ The module output channel loop power supply requires 24VDC external power supply.

2 Technical parameters

General Parameters	
Power	Max.175mA@5.0VDC
Isolation	I/O to internal bus: opto-couple isolation (3KVrms)
Field Power	Nominal:24VDC, Range:20.4-28.8VDC
Wiring	Max.: AWG 18 Min.: AWG 24
Installation	35mm DIN-Rail
Size	115*14*75mm
Weight	65g
Environment Specification	
Operating Temperature of Horizontal Installation	-35°C~70°C
Operating Temperature of Vertical Installation	-35°C~60°C
Relative Humidity	< 95%RH (No Condensation)
Storage Temperature	-40°C~85°C
Storage Humidity	< 95%RH (No Condensation)
Manufacturing Test Temperature	-40°C~75°C
Ingress Protection Rating	IP20
Output Parameters	
Channel Number	16 channel source type output
LED Indicator	16 channel output LED indicator
Rated Current	Typical value: 500mA
Leakage Current	Max: 10uA
Output Impedance	<200mΩ
Output Delay	OFF to ON: Max.100us ON to OFF: Max.150us
Protection	Overtemperature shutdown: typical value is 135°C Overcurrent protection: typical value 1.1A Short circuit protection support
Load type	General use and Resistive, Pilot Duty

 **WARNING**

UNEXPECTED EQUIPMENT OPERATION

Do not exceed any of the ratings specified in the environmental and electrical characteristics table.

Failure to follow instructions specified by the manufacturer may result in serious consequences such as death, personal injury, or damage to equipment since the protection provided by the equipment may be impaired.

 **AVERTISSEMENT**

FONCTIONNEMENT INATTENDU DE L'EQUIPEMENT

Ne dépassez aucune évaluation spécifiée dans le tableau de caractéristiques environnementales et électriques..

Le fait de ne pas suivre les instructions peut entraîner une défaillance de la protection fournie par l'équipement, ce qui peut entraîner des conséquences graves, comme des blessures ou des dommages à l'équipement.

3 Hardware interfaces

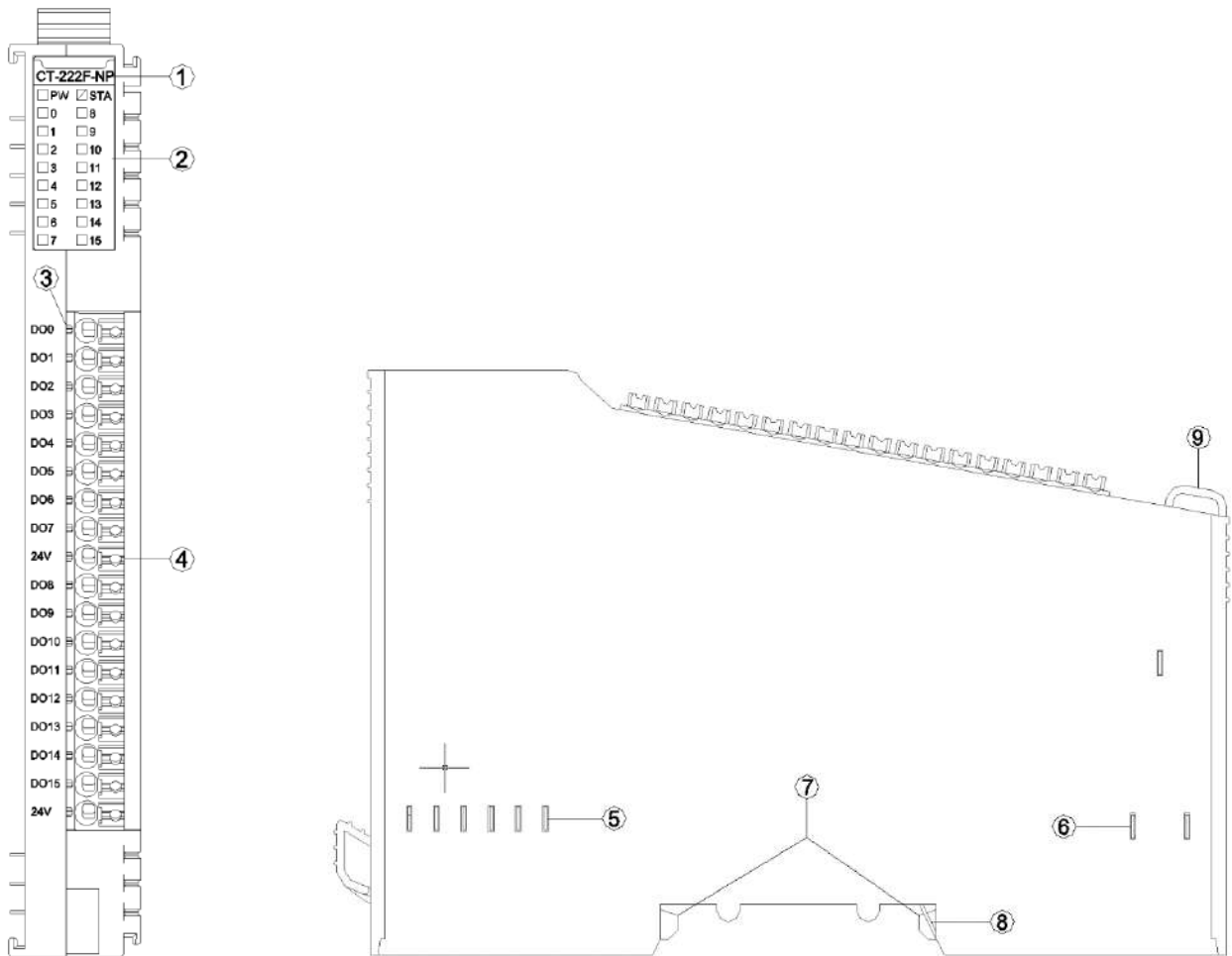

- ① Module Type
- ② State indicator
- ③ Channel indicator
- ④ Wiring Terminal and identification
- ⑤ Internal Bus
- ⑥ Field Power
- ⑦ Buckle
- ⑧ Grounding Spring Sheet
- ⑨ Fixed Wiring Harness

3.1 LED indicator definition

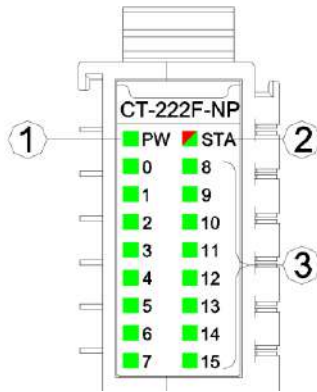

- ① Power LED indicator (green)
- ② Module State indicator LED (red/green)
- ③ Output channel indicator LED (green)

PW Power State	Definition
ON	Internal bus power supply normal
OFF	Internal bus power supply failure
STA Module State (RED/GREEN)	Definition
Green slow flash (2.5 Hz)	Module internal bus is not started
Red slow flash (2.5 Hz)	Module internal bus offline
ON (GREEN)	Operation normal
Flash (2.5 Hz) (RED/GREEN)	Updating mode
Flash (10 Hz) (RED/GREEN)	Firmware update
Double Flash (RED)	Module exception has been soft-restarted
0-15 channel indicator LED	Definition
ON	Output signal valid
OFF	Output signal invalid

! WARNING

UNEXPECTED EQUIPMENT OPERATION

By viewing the PW indicator, could determine the power supply status of a module. If the PW is steady green, the power supply is normal. Otherwise, the module cannot work properly.

When the module is initially powered on, there will be 3S for the backplane bus connection. After the backplane bus is initialized, STA is in the green steady state. If STA is in the green blinking state, it indicates that the backplane bus has not been initialized, and it needs to be powered off and restarted for re-initialization.

STA abnormal working state occurs during the normal operation of the module, please check the firmware version information of all modules, and consult ODOT technical support for details.

If a module is upgraded, check that all modules are in the normal state after the upgrade. Otherwise, an exception may occur.

Failure to follow instructions specified by the manufacturer may result in serious

consequences such as death, personal injury, or damage to equipment since the protection provided by the equipment may be impaired.

⚠️ AVERTISSEMENT

FONCTIONNEMENT INATTENDU DE L'ÉQUIPEMENT

En regardant l'état de l'indicateur de PW, jugez l'état d'alimentation du module. Le feu vert PW reste allumé et l'alimentation est normale. Autrement, le module ne fonctionnera pas correctement.

Lorsque le module est alimenté initialement, il y aura 3S pour la connexion de bus de backboard. STA est un état vert permanent après l'initialisation du bus de backboard. Si STA est en état de clignotement vert, cela signifie que l'initialisation du bus de backboard n'est pas passée et doit être redémarrée hors tension et réinitialisée.

L'état de fonctionnement anormal de STA se produit pendant le fonctionnement normal du module, veuillez vérifier les informations de version du firmware de tous les modules, et consulter le support technique ODOT pour plus de détails.

Si le module a une opération de mise à niveau, après l'achèvement de la mise à niveau, le besoin de vérifier que tous les modules sont dans l'état normal avant de courir, sinon il conduira à une exception.

Le fait de ne pas suivre les instructions peut entraîner une défaillance de la protection fournie par l'équipement, ce qui peut entraîner des conséquences graves, comme des blessures ou des dommages à l'équipement.

3.2 Field channel LED indicator (Green)

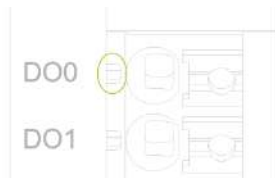

When output signal of output channel is valid, the corresponding field channel LED indicator is on.

3.3 Terminal definition

Terminal Number	Symbol	The Description
1	DO0	Signal output
2	DO1	
3	DO2	
4	DO3	
5	DO4	
6	DO5	
7	DO6	
8	DO7	
9	24V	Power input <i>(note1)</i>
10	DO8	Signal output
11	DO9	
12	DO10	
13	DO11	
14	DO12	
15	DO13	
16	DO14	
17	DO15	
18	24V	Power input <i>(note1)</i>

Note 1:

When the 24VDC power is supplied to the 24V wiring terminal separately, the maximum sum of all the output channel currents is 8A

WARNING

UNEXPECTED EQUIPMENT OPERATION

Calculate the maximum field power current consumption of a single module based on the actual field load. If the total field power current consumption of all I/O modules exceeds the power supply capacity of the field power supply, you must add an extra power expansion module. Otherwise, an output channel exception may occur.

Failure to follow instructions specified by the manufacturer may result in serious consequences such as death, personal injury, or damage to equipment since the protection provided by the equipment may be impaired.

AVERTISSEMENT

FONCTIONNEMENT INATTENDU DE L'EQUIPEMENT

Calculez la consommation maximale de courant de champ d'un seul module en fonction de la charge de champ réelle. Si la consommation totale de courant de champ de tous les modules d'E/S dépasse la capacité d'alimentation de l'alimentation de champ, vous devez ajouter un module d'extension de puissance supplémentaire. Dans le cas contraire, une exception de canal de sortie peut se produire.

Le fait de ne pas suivre les instructions peut entraîner une défaillance de la protection fournie

par l'équipement, ce qui peut entraîner des conséquences graves, comme des blessures ou des dommages à l'équipement.

When connecting a cold-pressed terminal, the terminal must be terminated and checked in strict accordance with the corresponding termination specifications or requirements, and connect the cold-pressed terminal according to the corresponding node serial number. The conductor should use copper conductor and the conductor core should be larger than 0.2mm^2 and smaller than 1mm^2 (AWG18~AWG24). Cold-pressed terminal parameters are as follows:

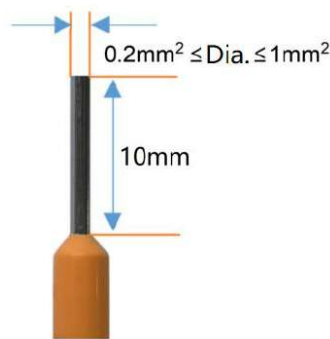

! WARNING

UNEXPECTED EQUIPMENT OPERATION

Strip the length of the conductor insulation layer is greater than 10mm to ensure reliable signal connection.

The wire needs to use copper wire and the wire core is greater than or equal to 0.2mm^2 and less than or equal to 1mm^2 to ensure reliable signal connection.

When connecting a cold-press terminal, connect the cold-press terminal strictly in accordance with the corresponding termination specifications or requirements, and connect the cold-press terminal according to the corresponding node serial number.

Do not power on cold-press terminals until they are properly connected or fully locked.

Failure to follow instructions specified by the manufacturer may result in serious consequences such as death, personal injury, or damage to equipment since the protection provided by the equipment may be impaired.

! AVERTISSEMENT

FONCTIONNEMENT INATTENDU DE L'EQUIPEMENT

Dépouillez la longueur de la couche isolante du fil plus de 10mm pour assurer la connexion fiable du signal.

Le conducteur doit utiliser le fil de cuivre et le noyau de fil est supérieur ou égal à $0,2\text{ mm}^2$, inférieur ou égal à 1mm^2 , afin d'assurer la connexion fiable du signal.

Lorsque les terminaux de presse à froid sont terminés, ils doivent être terminés et visualisés en stricte conformité avec les spécifications ou les exigences correspondantes et terminés selon le

numéro de série de noeud correspondant.

Il est interdit d'activer les bornes à froid avant qu'elles ne soient correctement articulées ou complètement verrouillées.

Le fait de ne pas suivre les instructions peut entraîner une défaillance de la protection fournie par l'équipement, ce qui peut entraîner des conséquences graves, comme des blessures ou des dommages à l'équipement.

DANGER

FIRE DANGER

Use the correct wiring rules only for the maximum current capacity of the I/O channel and power supply.

Failure to follow instructions specified by the manufacturer may result in serious consequences such as death, personal injury, or damage to equipment since the protection provided by the equipment may be impaired.

WARNING

UNEXPECTED EQUIPMENT OPERATION

Do not exceed any of the ratings specified in the environmental and electrical characteristics table.

Failure to follow instructions specified by the manufacturer may result in serious consequences such as death, personal injury, or damage to equipment since the protection provided by the equipment may be impaired.

AVERTISSEMENT

FONCTIONNEMENT INATTENDU DE L'EQUIPEMENT

Ne dépassez aucune évaluation spécifiée dans le tableau de caractéristiques environnementales et électriques..

Le fait de ne pas suivre les instructions peut entraîner une défaillance de la protection fournie par l'équipement, ce qui peut entraîner des conséquences graves, comme des blessures ou des dommages à l'équipement.

4 Wiring

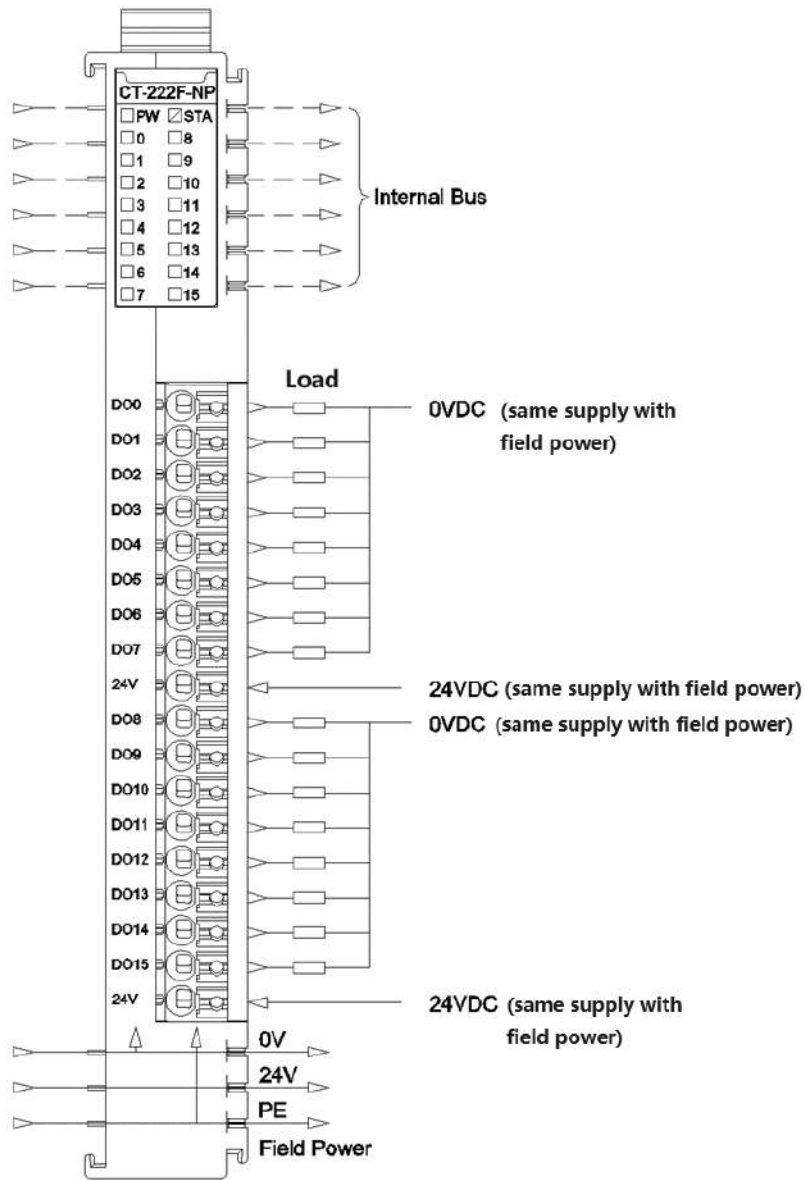

NOTICE

EQUIPMENT INOPERABLE

Do not crimp the spring terminal with more than the maximum pressure specified for the terminal. Otherwise, the resilience of the spring terminal may be damaged and the terminal rebound may be affected.

Do not press the spring terminal with a sharp tool when removing cable from the channel. Otherwise, the spring terminal will be damaged.

Failure to follow these instructions may result in equipment damage.

5 Process data definition

Output data								
Bit No	Bit 7	Bit 6	Bit 5	Bit 4	Bit 3	Bit 2	Bit 1	Bit 0
Byte 0	DO Ch#7	DO Ch#6	DO Ch#5	DO Ch#4	DO Ch#3	DO Ch#2	DO Ch#1	DO Ch#0
Byte 1	DO Ch#15	DO Ch#14	DO Ch#13	DO Ch#12	DO Ch#11	DO Ch#10	DO Ch#9	DO Ch#8

Data description:

DO Ch#(0-15): when this bit is 1, the corresponding channel output signal is valid, the output is high level, and the output is invalid when it is 0.

0: Output signal is invalid

1: Output signal is valid

6 Configuration parameter definitions

Configuration parameters								
Bit No	Bit 7	Bit 6	Bit 5	Bit 4	Bit 3	Bit 2	Bit 1	Bit 0
Byte 0	Fault Action for Output Ch#7	Fault Action for Output Ch#6	Fault Action for Output Ch#5	Fault Action for Output Ch#4	Fault Action for Output Ch#3	Fault Action for Output Ch#2	Fault Action for Output Ch#1	Fault Action for Output Ch#0
Byte 1	Fault Action for Output Ch#15	Fault Action for Output Ch#14	Fault Action for Output Ch#13	Fault Action for Output Ch#12	Fault Action for Output Ch#11	Fault Action for Output Ch#10	Fault Action for Output Ch#9	Fault Action for Output Ch#8
Byte 2	Fault Value for Output Ch#7	Fault Value for Output Ch#6	Fault Value for Output Ch#5	Fault Value for Output Ch#4	Fault Value for Output Ch#3	Fault Value for Output Ch#2	Fault Value for Output Ch#1	Fault Value for Output Ch#0
Byte 3	Fault Value for Output Ch#15	Fault Value for Output Ch#14	Fault Value for Output Ch#13	Fault Value for Output Ch#12	Fault Value for Output Ch#11	Fault Value for Output Ch#10	Fault Value for Output Ch#9	Fault Value for Output Ch#8

Data description:

Fault Action for Output Ch#(0-15): Fault Output mode. When the IO module detects an internal bus exception and fails to communicate with the adapter. And the module will turn to offline mode, so the output data is processed in this way. (Default: 0)

0: keep the last time output State.

1: output fault value.

Fault Value for Output Ch#(0-15): when the Fault Output mode is 1, this bit sets the Fault Output Value, and this setting value will be outputted when the internal bus of IO module is offline. (default: 0)

0: Output low level.

1: Output high level.

A Dimension drawing

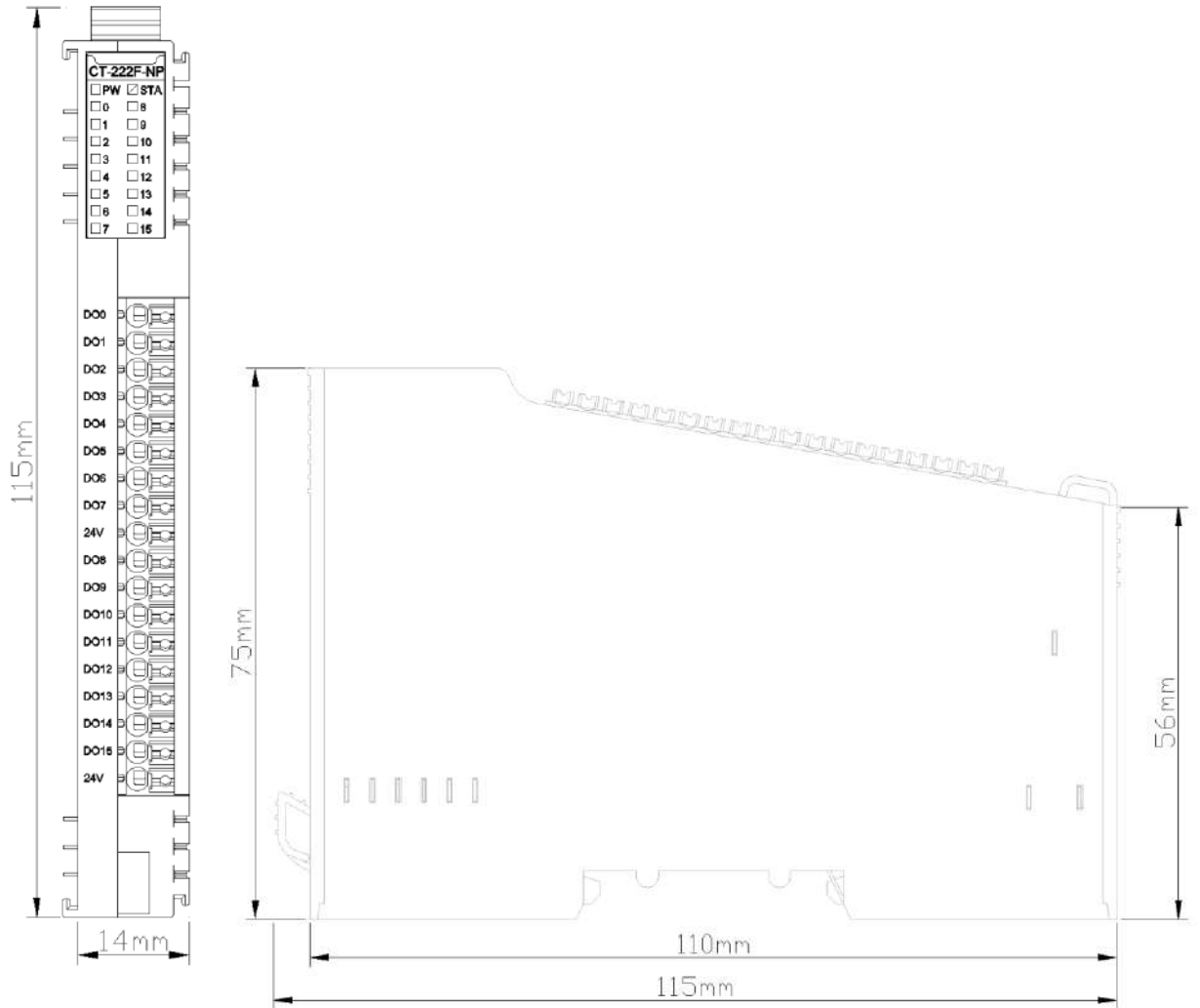

CT-222H 32 channels digital output/24VDC/PNP

1 Module features

- ◆ The module supports 32 channels digital output; the output voltage is 24VDC and the output high level is valid.
- ◆ Module can drive field equipment. (relay, solenoid valve, etc.)
- ◆ The internal bus of the module and field output are using opto-coupler.
- ◆ The module carries 32 digital output channel LED indicator light.
- ◆ The module has the functions of thermal shutdown and overcurrent protection.
- ◆ The module supports short circuit protection and overload protection.

2 Technical parameters

General Parameters	
Power	Max.185mA@5.0VDC
Isolation	I/O to internal bus: opto-couple isolation (3KVrms)
Field Power	Nominal:24VDC, Range:20.4-28.8VDC
Wiring	34P male connector 2.54mm Pin header
Installation	35mm DIN-Rail
Size	115*14*75mm
Weight	65g
Vibration Resistance	Comply with IEC 61131-2 and EC 60068-2-6
Impact resistance	Comply with IEC 61131-2 and IEC 60068-2-27
EMC Performance	Comply with IEC 61131-2 and IEC 61000-4
Environment Specification	
Operating Temperature of Horizontal Installation	-35°C~70°C
Operating Temperature of Vertical Installation	-35°C~60°C
Relative Humidity	< 95%RH (No Condensation)
Storage Temperature	-40°C~85°C
Storage Humidity	< 95%RH (No Condensation)
Manufacturing Test Temperature	-40°C~75°C
Ingress Protection Rating	IP20
Output Parameters	
Channel Number	32 channels source type output
LED Indicator	32 channel output LED indicator
Rated Current	Typical value: 300mA
Leakage Current	Max: 10uA
Output Impedance	<200mΩ
Output Delay	OFF to ON: Max.100us ON to OFF: Max.150us
Protection	Overtemperature shutdown: typical value is 135°C Overcurrent protection: typical value 1.1A Short circuit protection support
Load type	General use and Resistive, Pilot Duty

 **WARNING**

UNEXPECTED EQUIPMENT OPERATION

Do not exceed any of the ratings specified in the environmental and electrical characteristics table.

Failure to follow instructions specified by the manufacturer may result in serious consequences such as death, personal injury, or damage to equipment since the protection provided by the equipment may be impaired.

 **AVERTISSEMENT**

FONCTIONNEMENT INATTENDU DE L'EQUIPEMENT

Ne dépassez aucune évaluation spécifiée dans le tableau de caractéristiques environnementales et électriques..

Le fait de ne pas suivre les instructions peut entraîner une défaillance de la protection fournie par l'équipement, ce qui peut entraîner des conséquences graves, comme des blessures ou des dommages à l'équipement.

3 Hardware interfaces

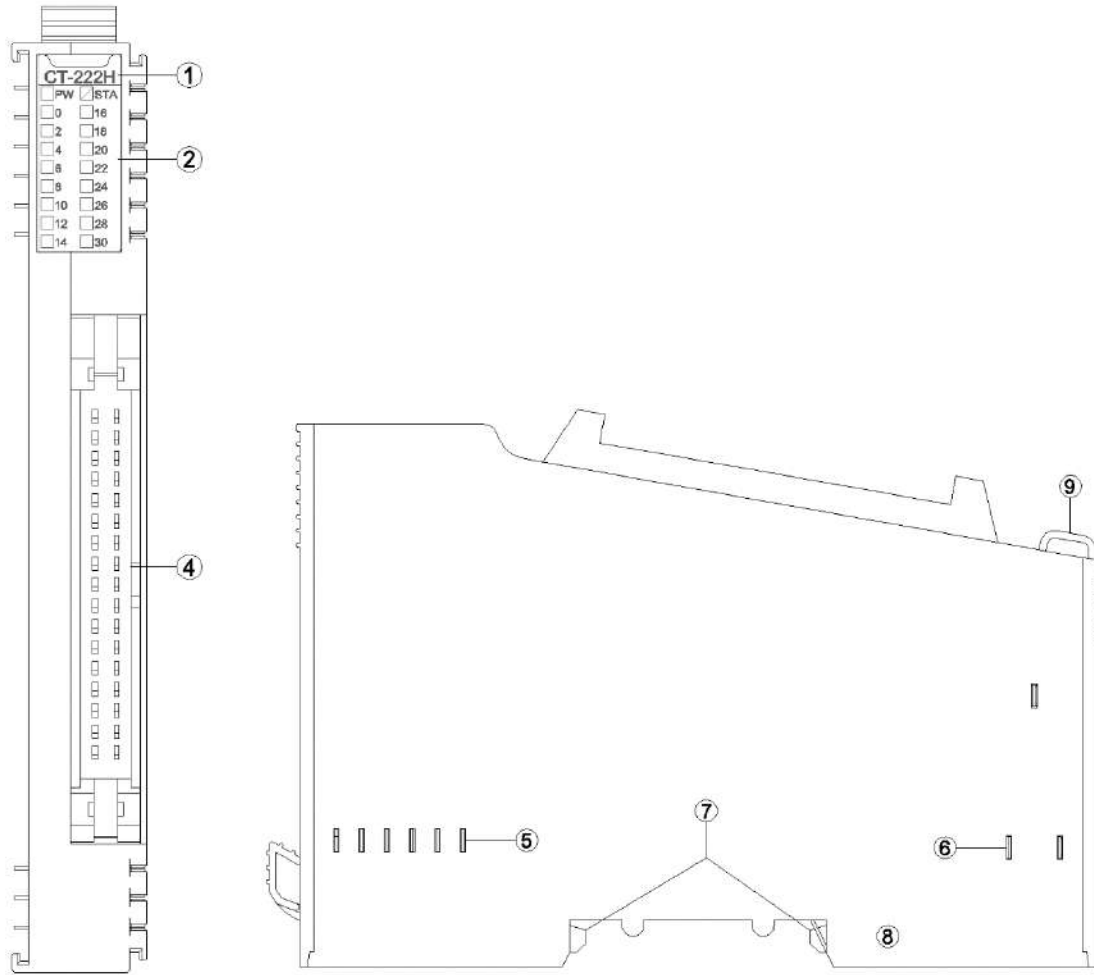

- ① Module Type
- ② State indicator
- ④ 34P male connector
- ⑤ Internal Bus
- ⑥ Field Power
- ⑦ Buckle
- ⑧ Grounding Spring Sheet
- ⑨ Fixed Wiring Harness

3.1 LED indicator definition

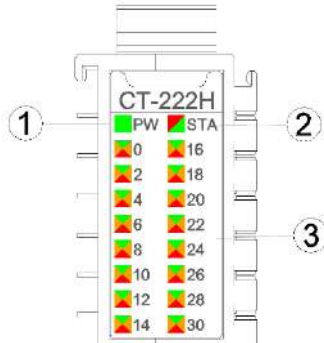

- ① Power LED indicator (green)
- ② Module State LED indicator (red/green)
- ③ Output channel LED indicator (green/red/orange)

PW Power State	Definition
ON	Internal bus power supply normal
OFF	Internal bus power supply failure
STA Module State	Definition
Green slow flash (2.5 Hz)	Module internal bus is not started
Red slow flash (2.5 Hz)	Module internal bus offline
ON (GREEN)	Operation normal
Flash (2.5 Hz) (RED/GREEN)	updating mode
Flash (10 Hz) (RED/GREEN)	firmware update
Double Flash (RED)	Module exception has been soft-restarted
0-31 channel indicator LED	Definition
ON (GREEN)	Indicates that the output channel signal is valid
ON (RED)	Indicates that the output channel +1 signal is valid
ON (ORANGE)	Indicates that the output channel and channel +1 signal are valid
OFF	Output signal is invalid

! WARNING

UNEXPECTED EQUIPMENT OPERATION

By viewing the PW indicator, could determine the power supply status of a module. If the PW is steady green, the power supply is normal. Otherwise, the module cannot work properly.

When the module is initially powered on, there will be 3S for the backplane bus connection. After the backplane bus is initialized, STA is in the green steady state. If STA is in the green blinking state, it indicates that the backplane bus has not been initialized, and it needs to be powered off and restarted for re-initialization.

STA abnormal working state occurs during the normal operation of the module, please check the firmware version information of all modules, and consult ODOT technical support for details.

If a module is upgraded, check that all modules are in the normal state after the upgrade.

Otherwise, an exception may occur.

Failure to follow instructions specified by the manufacturer may result in serious consequences such as death, personal injury, or damage to equipment since the protection provided by the equipment may be impaired.

AVERTISSEMENT

FONCTIONNEMENT INATTENDU DE L'EQUIPEMENT

En regardant l'état de l'indicateur de PW, jugez l'état d'alimentation du module. Le feu vert PW reste allumé et l'alimentation est normale. Autrement, le module ne fonctionnera pas correctement.

Lorsque le module est alimenté initialement, il y aura 3S pour la connexion de bus de backboard. STA est un état vert permanent après l'initialisation du bus de backboard. Si STA est en état de clignotement vert, cela signifie que l'initialisation du bus de backboard n'est pas passée et doit être redémarrée hors tension et réinitialisée.

L'état de fonctionnement anormal de STA se produit pendant le fonctionnement normal du module, veuillez vérifier les informations de version du firmware de tous les modules, et consulter le support technique ODOT pour plus de détails.

Si le module a une opération de mise à niveau, après l'achèvement de la mise à niveau, le besoin de vérifier que tous les modules sont dans l'état normal avant de courir, sinon il conduira à une exception.

Le fait de ne pas suivre les instructions peut entraîner une défaillance de la protection fournie par l'équipement, ce qui peut entraîner des conséquences graves, comme des blessures ou des dommages à l'équipement.

3.2 Terminal definition

Description	Symbol	Terminal Number	Terminal Number	Symbol	Description
Signal Output	DO0	1	18	DO16	Signal Output
	DO1	2	19	DO17	
	DO2	3	20	DO18	
	DO3	4	21	DO19	
	DO4	5	22	DO20	
	DO5	6	23	DO21	
	DO6	7	24	DO22	
	DO7	8	25	DO23	
	DO8	9	26	DO24	
	DO9	10	27	DO25	
	DO10	11	28	DO26	
	DO11	12	29	DO27	
	DO12	13	30	DO28	
	DO13	14	31	DO29	
	DO14	15	32	DO30	
DO15	16	33	DO31		
24V	24V	17	34	24V	24V

Pins 17 and 34 are internally short-circuited.

3.3 External terminal block

Module number	MTC034	MTE034
Name	Scre terminal block	Spring terminal block
Suitable cable	DX210-3SFX-2000	
Nominal current	1A	
Nominal voltage	DC24V	
Wiring	Max. AWG 18	

MTE034

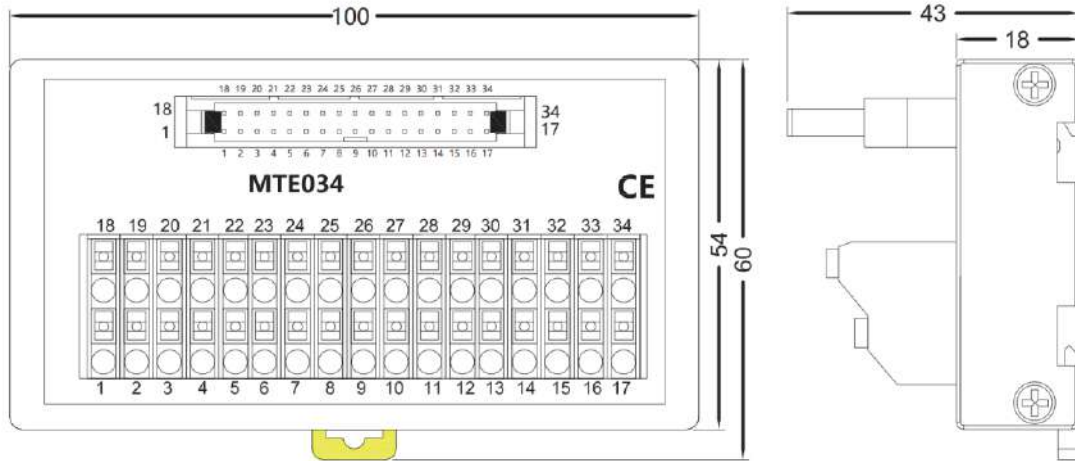

MTC034

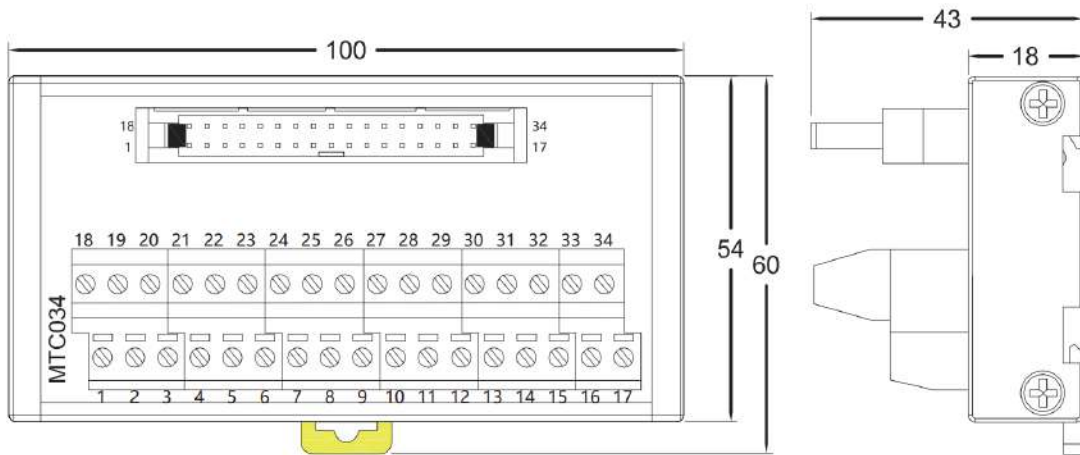

4 Wiring

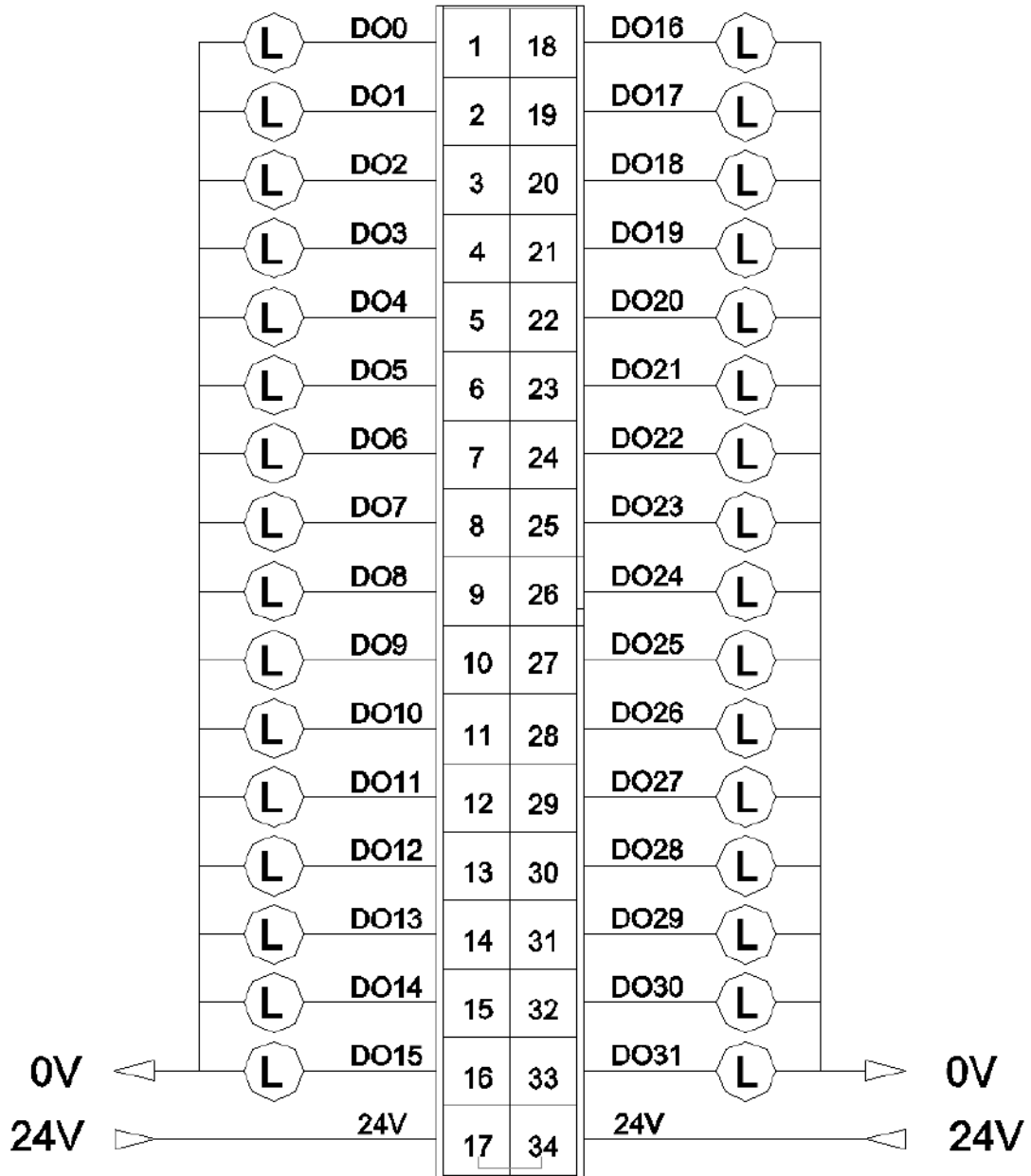

Terminals 17 and 34 are internally short-circuited

5 Process data definition

Output data								
Bit No	Bit 7	Bit 6	Bit 5	Bit 4	Bit 3	Bit 2	Bit 1	Bit 0
Byte 0	DO Ch#7	DO Ch#6	DO Ch#5	DO Ch#4	DO Ch#3	DO Ch#2	DO Ch#1	DO Ch#0
Byte 1	DO Ch#15	DO Ch#14	DO Ch#13	DO Ch#12	DO Ch#11	DO Ch#10	DO Ch#9	DO Ch#8
Byte 2	DO Ch#23	DO Ch#22	DO Ch#21	DO Ch#20	DO Ch#19	DO Ch#18	DO Ch#17	DO Ch#16
Byte 3	DO Ch#31	DO Ch#30	DO Ch#29	DO Ch#28	DO Ch#27	DO Ch#26	DO Ch#25	DO Ch#24

Data description:

DO Ch#(0-31): when this bit is 1, the corresponding channel output signal is valid, the output is high level, and the output is invalid when it is 0.

0: Output signal is invalid

1: Output signal is valid

6 Configuration parameter definitions

Configuration parameters								
Bit No	Bit 7	Bit 6	Bit 5	Bit 4	Bit 3	Bit 2	Bit 1	Bit 0
Byte 0	Fault Action for Output Ch#7	Fault Action for Output Ch#6	Fault Action for Output Ch#5	Fault Action for Output Ch#4	Fault Action for Output Ch#3	Fault Action for Output Ch#2	Fault Action for Output Ch#1	Fault Action for Output Ch#0
Byte 1	Fault Action for Output Ch#15	Fault Action for Output Ch#14	Fault Action for Output Ch#13	Fault Action for Output Ch#12	Fault Action for Output Ch#11	Fault Action for Output Ch#10	Fault Action for Output Ch#9	Fault Action for Output Ch#8
Byte 2	Fault Action for Output Ch#23	Fault Action for Output Ch#22	Fault Action for Output Ch#21	Fault Action for Output Ch#20	Fault Action for Output Ch#19	Fault Action for Output Ch#18	Fault Action for Output Ch#17	Fault Action for Output Ch#16
Byte 3	Fault Action for Output Ch#31	Fault Action for Output Ch#30	Fault Action for Output Ch#29	Fault Action for Output Ch#28	Fault Action for Output Ch#27	Fault Action for Output Ch#26	Fault Action for Output Ch#25	Fault Action for Output Ch#24

Byte 4	Fault Value for Output Ch#7	Fault Value for Output Ch#6	Fault Value for Output Ch#5	Fault Value for Output Ch#4	Fault Value for Output Ch#3	Fault Value for Output Ch#2	Fault Value for Output Ch#1	Fault Value for Output Ch#0
Byte 5	Fault Value for Output Ch#15	Fault Value for Output Ch#14	Fault Value for Output Ch#13	Fault Value for Output Ch#12	Fault Value for Output Ch#11	Fault Value for Output Ch#10	Fault Value for Output Ch#9	Fault Value for Output Ch#8
Byte 6	Fault Value for Output Ch#23	Fault Value for Output Ch#22	Fault Value for Output Ch#21	Fault Value for Output Ch#20	Fault Value for Output Ch#19	Fault Value for Output Ch#18	Fault Value for Output Ch#17	Fault Value for Output Ch#16
Byte 7	Fault Value for Output Ch#31	Fault Value for Output Ch#30	Fault Value for Output Ch#29	Fault Value for Output Ch#28	Fault Value for Output Ch#27	Fault Value for Output Ch#26	Fault Value for Output Ch#25	Fault Value for Output Ch#24

Data description:

Fault Action for Output Ch#(0-31): Fault Output mode. When the IO module detects an internal bus exception and fails to communicate with the adapter. And the module will turn to offline mode, so the output data is processed in this way. (default: 0)

0: keep the last time output State.

1: output fault value.

Fault Value for Output Ch#(0-31): when the Fault Output mode is 1, this bit sets the Fault Output Value, and this setting value will be outputted when the internal bus of IO module is offline. (default: 0)

0: Output low level.

1: Output high level.

A Dimension drawing

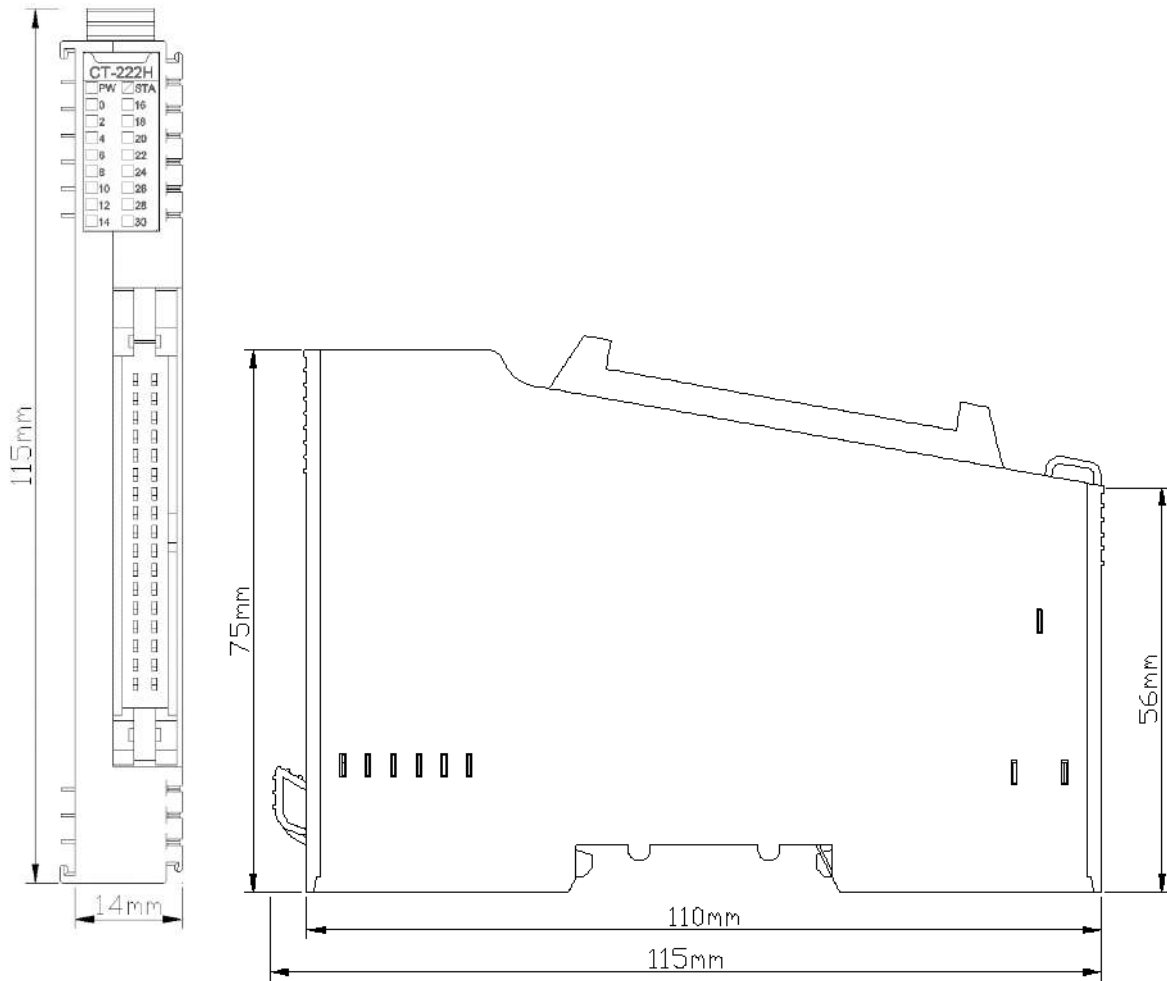

CT-222D 32 channels digital output/24VDC/Sink

1 Module features

- ◆ The module supports 32 channels digital output; the output voltage is 24VDC and the output high level is valid.
- ◆ Module can drive field equipment. (relay, solenoid valve, etc.)
- ◆ The internal bus of the module and field output are using opto-coupler.
- ◆ The module carries 32 digital output channel LED indicator light.
- ◆ The module has the functions of thermal shutdown and overcurrent protection.
- ◆ The module supports short circuit protection and overload protection.

2 Technical Parameters

General Parameters	
Power	Max.82mA@5.0VDC
Isolation	Channel and system power isolation voltage: AC 500V Channel and on-site power supply isolation voltage: AC 500V Channel and PE isolation voltage: AC 500V
Field Power	Nominal: 24VDC Input range: 20.4~28.8VDC Module alarm when the voltage is lower than 15~17V
Connection	Max.: AWG 18 Min.: AWG 24
Installation:	35mm DIN-Rail
Size	115*27*75mm
Weight	130g
Vibration Resistance	Comply with IEC 61131-2 and IEC 60068-2-6
Impact Resistance	Comply with IEC 61131-2 and I IEC 60068-2-27
EMC Performance	Comply with IEC 61131-2 and I IEC 61000-4
Environmental Parameters	
Operating Temperature of Horizontal Installation	-35°C~70°C
Operating Temperature of Vertical Installation	-35°C~60°C
Relative Humidity	< 95%RH non-condensing
Storage Temperature	-40°C~85°C
Storage Humidity	< 95%RH non-condensing
Manufacturing Test Temperature	-40°C~75°C
Ingress Protection Rating	IP20
Output Parameters	
Number of Channels	32 channels
LED Indicator	32 panel LEDs and 32 channel LEDs, all green
Current Rating	Single-channel current: Max.1A Current per channel: 0.5A
Leakage Current	Maximum: 5uA
On-resistance	Typical: 260mΩ
Output Delay	OFF to ON: Max.100us ON to OFF: Max.150us
Protection Features	Over temperature shutdown: typical value of 150 °C Overcurrent protection: 1.3-1.8A Short circuit protection: supported Channel isolation protection
The Type of Load	General use and Resistive, Pilot Duty
Output type	Source type output/high edge output

 **WARNING**

UNEXPECTED EQUIPMENT OPERATION

Do not exceed any of the ratings specified in the environmental and electrical characteristics table.

Failure to follow instructions specified by the manufacturer may result in serious consequences such as death, personal injury, or damage to equipment since the protection provided by the equipment may be impaired.

 **AVERTISSEMENT**

FONCTIONNEMENT INATTENDU DE L'EQUIPEMENT

Ne dépassez aucune évaluation spécifiée dans le tableau de caractéristiques environnementales et électriques..

Le fait de ne pas suivre les instructions peut entraîner une défaillance de la protection fournie par l'équipement, ce qui peut entraîner des conséquences graves, comme des blessures ou des dommages à l'équipement.

3 Hardware interface

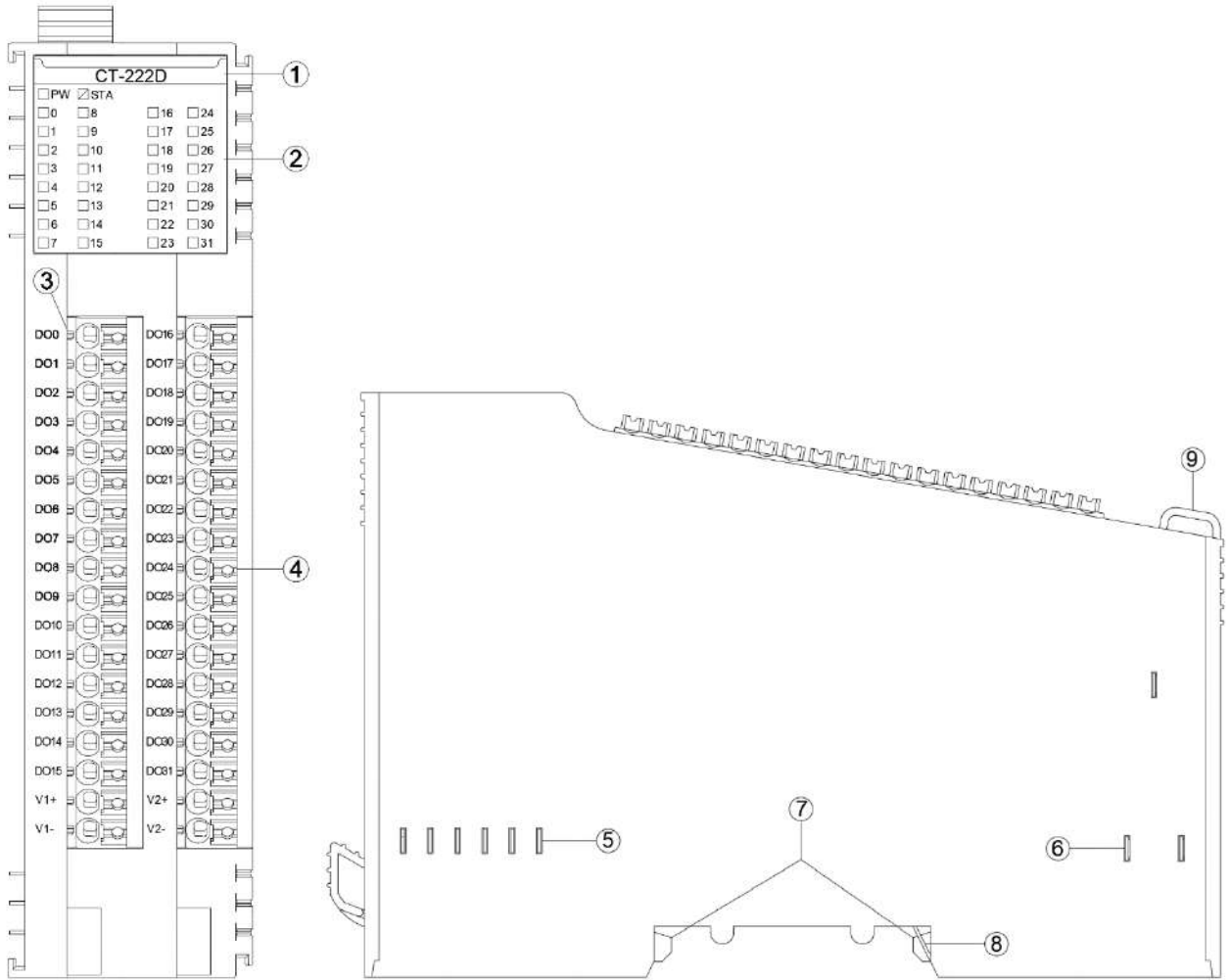

- ① Module Type
- ② State indicator
- ③ Channel indicator
- ④ Wiring Terminal and identification
- ⑤ Internal Bus
- ⑥ Field Power
- ⑦ Buckle
- ⑧ Grounding Spring Sheet
- ⑨ Fixed Wiring Harness

3.1 LED Indicator Definition

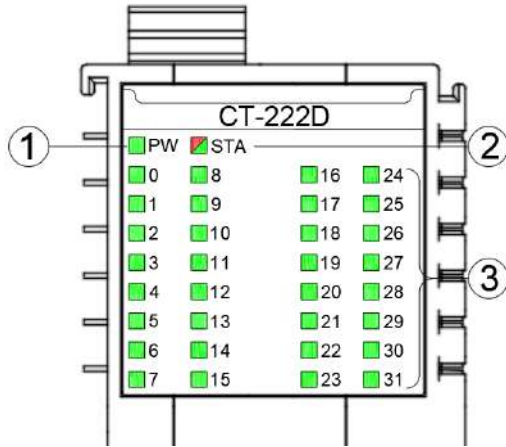

- ① Power LED indicator (green)
- ② Module State indicator LED (red/green)
- ③ Output Channel indicator LED (green)

PW Power State (GREEN)	Definition
ON	Internal bus power supply normal
OFF	Internal bus power supply failure
STA Module State (RED/GREEN)	Definition
Green slow flash (2.5 Hz)	Module internal bus is not started
Red slow flash (2.5 Hz)	Module internal bus offline
ON (GREEN)	Operation normal
Flash (2.5 Hz) (RED/GREEN)	Upgrading mode
Flash (10 Hz) (RED/GREEN)	Firmware upgrading
Double Flash (RED)	Module exception has been soft-restarted
0-31 Channel indicator LED	Definition
ON (GREEN)	Indicates that the output channel signal is valid
OFF	Output signal is invalid

WARNING

UNEXPECTED EQUIPMENT OPERATION

By viewing the PW indicator, could determine the power supply status of a module. If the PW is steady green, the power supply is normal. Otherwise, the module cannot work properly.

When the module is initially powered on, there will be 3S for the backplane bus connection. After the backplane bus is initialized, STA is in the green steady state. If STA is in the green blinking state, it indicates that the backplane bus has not been initialized, and it needs to be powered off and restarted for re-initialization.

STA abnormal working state occurs during the normal operation of the module, please check the firmware version information of all modules, and consult ODOT technical support for details.

If a module is upgraded, check that all modules are in the normal state after the upgrade. Otherwise, an exception may occur.

Failure to follow instructions specified by the manufacturer may result in serious consequences such as death, personal injury, or damage to equipment since the protection provided by the equipment may be impaired.

AVERTISSEMENT

FONCTIONNEMENT INATTENDU DE L'EQUIPEMENT

En regardant l'état de l'indicateur de PW, jugez l'état d'alimentation du module. Le feu vert PW reste allumé et l'alimentation est normale. Autrement, le module ne fonctionnera pas correctement.

Lorsque le module est alimenté initialement, il y aura 3S pour la connexion de bus de backboard. STA est un état vert permanent après l'initialisation du bus de backboard. Si STA est en état de clignotement vert, cela signifie que l'initialisation du bus de backboard n'est pas passée et doit être redémarrée hors tension et réinitialisée.

L'état de fonctionnement anormal de STA se produit pendant le fonctionnement normal du module, veuillez vérifier les informations de version du firmware de tous les modules, et consulter le support technique ODOT pour plus de détails.

Si le module a une opération de mise à niveau, après l'achèvement de la mise à niveau, le besoin de vérifier que tous les modules sont dans l'état normal avant de courir, sinon il conduira à une exception.

Le fait de ne pas suivre les instructions peut entraîner une défaillance de la protection fournie par l'équipement, ce qui peut entraîner des conséquences graves, comme des blessures ou des dommages à l'équipement.

3.2 Terminal Definition

Illustrate	Symbol	Terminal serial number	Terminal serial number	Symbol	Illustrate
Signal output	DO0	1	19	DO16	Signal output
	DO1	2	20	DO17	
	DO2	3	21	DO18	
	DO3	4	22	DO19	
	DO4	5	23	DO20	
	DO5	6	24	DO21	
	DO6	7	25	DO22	
	DO7	8	26	DO23	
	DO8	9	27	DO24	
	DO9	10	28	DO25	
	DO10	11	29	DO26	
	DO11	12	30	DO27	
	DO12	13	31	DO28	
	DO13	14	32	DO29	
	DO14	15	33	DO30	
	DO15	16	34	DO31	
24V	V1+	17	35	V2+	24V
0V	V1-	18	36	V2-	0V

WARNING

UNEXPECTED EQUIPMENT OPERATION

Calculate the maximum field power current consumption of a single module based on the actual field load. If the total field power current consumption of all I/O modules exceeds the power supply capacity of the field power supply, you must add an extra power expansion module. Otherwise, an output channel exception may occur.

Failure to follow instructions specified by the manufacturer may result in serious consequences such as death, personal injury, or damage to equipment since the protection provided by the equipment may be impaired.

AVERTISSEMENT

FONCTIONNEMENT INATTENDU DE L'EQUIPEMENT

Calculez la consommation maximale de courant de champ d'un seul module en fonction de la charge de champ réelle. Si la consommation totale de courant de champ de tous les modules d'E/S dépasse la capacité d'alimentation de l'alimentation de champ, vous devez ajouter un module d'extension de puissance supplémentaire. Dans le cas contraire, une exception de canal de sortie peut se produire.

Le fait de ne pas suivre les instructions peut entraîner une défaillance de la protection fournie

par l'équipement, ce qui peut entraîner des conséquences graves, comme des blessures ou des dommages à l'équipement.

When connecting a cold-pressed terminal, the terminal must be terminated and checked in strict accordance with the corresponding termination specifications or requirements, and connect the cold-pressed terminal according to the corresponding node serial number. The conductor should use copper conductor and the conductor core should be larger than 0.2mm^2 and smaller than 1mm^2 (AWG18~AWG24). Cold-pressed terminal parameters are as follows:

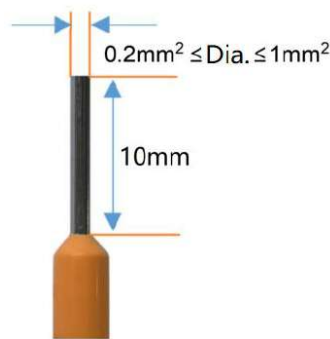

! WARNING

UNEXPECTED EQUIPMENT OPERATION

Strip the length of the conductor insulation layer is greater than 10mm to ensure reliable signal connection.

The wire needs to use copper wire and the wire core is greater than or equal to 0.2mm^2 and less than or equal to 1mm^2 to ensure reliable signal connection.

When connecting a cold-press terminal, connect the cold-press terminal strictly in accordance with the corresponding termination specifications or requirements, and connect the cold-press terminal according to the corresponding node serial number.

Do not power on cold-press terminals until they are properly connected or fully locked.

Failure to follow instructions specified by the manufacturer may result in serious consequences such as death, personal injury, or damage to equipment since the protection provided by the equipment may be impaired.

! AVERTISSEMENT

FONCTIONNEMENT INATTENDU DE L'EQUIPEMENT

Dépouillez la longueur de la couche isolante du fil plus de 10mm pour assurer la connexion fiable du signal.

Le conducteur doit utiliser le fil de cuivre et le noyau de fil est supérieur ou égal à $0,2\text{ mm}^2$, inférieur ou égal à 1mm^2 , afin d'assurer la connexion fiable du signal.

Lorsque les terminaux de presse à froid sont terminés, ils doivent être terminés et visualisés en stricte conformité avec les spécifications ou les exigences correspondantes et terminés selon le

numéro de série de noeud correspondant.

Il est interdit d'activer les bornes à froid avant qu'elles ne soient correctement articulées ou complètement verrouillées.

Le fait de ne pas suivre les instructions peut entraîner une défaillance de la protection fournie par l'équipement, ce qui peut entraîner des conséquences graves, comme des blessures ou des dommages à l'équipement.

DANGER

FIRE DANGER

Use the correct wiring rules only for the maximum current capacity of the I/O channel and power supply.

Failure to follow instructions specified by the manufacturer may result in serious consequences such as death, personal injury, or damage to equipment since the protection provided by the equipment may be impaired.

WARNING

UNEXPECTED EQUIPMENT OPERATION

Do not exceed any of the ratings specified in the environmental and electrical characteristics table.

Failure to follow instructions specified by the manufacturer may result in serious consequences such as death, personal injury, or damage to equipment since the protection provided by the equipment may be impaired.

AVERTISSEMENT

FONCTIONNEMENT INATTENDU DE L'EQUIPEMENT

Ne dépassez aucune évaluation spécifiée dans le tableau de caractéristiques environnementales et électriques..

Le fait de ne pas suivre les instructions peut entraîner une défaillance de la protection fournie par l'équipement, ce qui peut entraîner des conséquences graves, comme des blessures ou des dommages à l'équipement.

4 Wiring

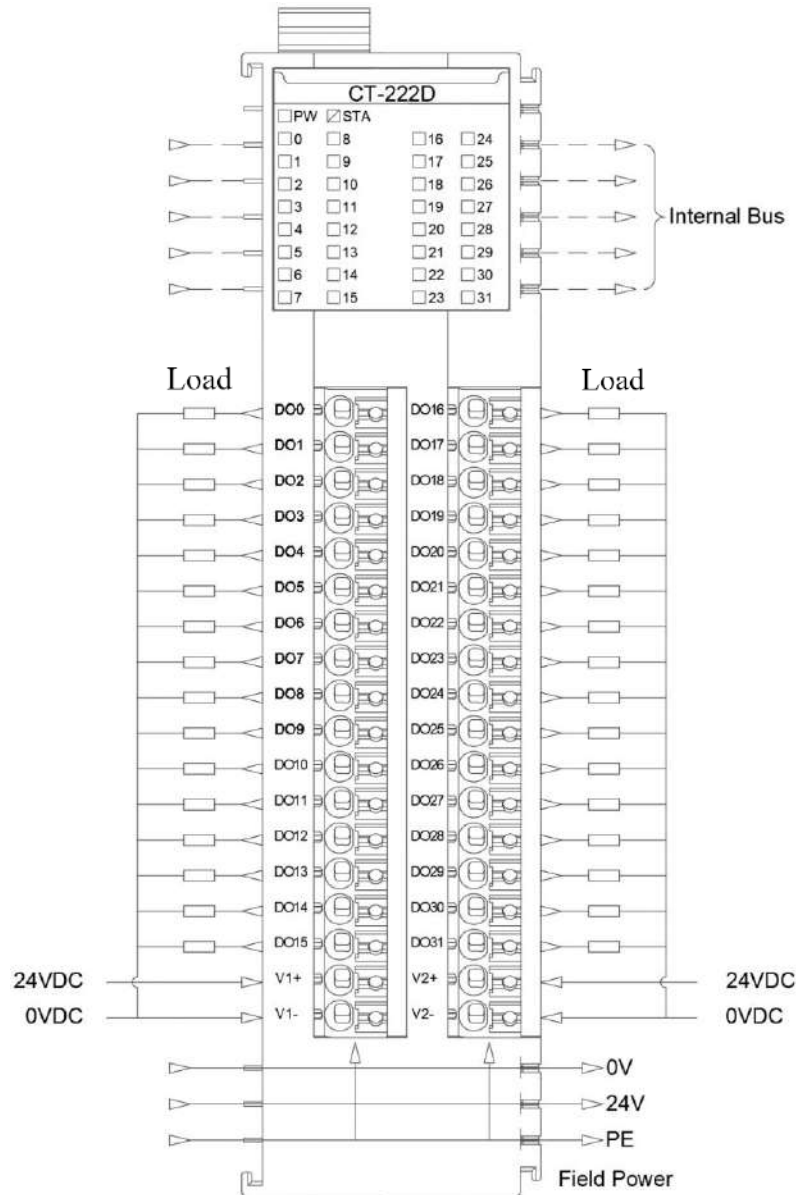

NOTICE

EQUIPMENT INOPERABLE

Do not crimp the spring terminal with more than the maximum pressure specified for the terminal. Otherwise, the resilience of the spring terminal may be damaged and the terminal rebound may be affected.

Do not press the spring terminal with a sharp tool when removing cable from the channel. Otherwise, the spring terminal will be damaged.

Failure to follow these instructions may result in equipment damage.

5 Process Data Definition

Output data								
Bit No	Bit 7	Bit 6	Bit 5	Bit 4	Bit 3	Bit 2	Bit 1	Bit 0
Byte 0	DO Ch#7	DO Ch#6	DO Ch#5	DO Ch#4	DO Ch#3	DO Ch#2	DO Ch#1	DO Ch#0
Byte 1	DO Ch#15	DO Ch#14	DO Ch#13	DO Ch#12	DO Ch#11	DO Ch#10	DO Ch#9	DO Ch#8
Byte 2	DO Ch#23	DO Ch#22	DO Ch#21	DO Ch#20	DO Ch#19	DO Ch#18	DO Ch#17	DO Ch#16
Byte 3	DO Ch#31	DO Ch#30	DO Ch#29	DO Ch#28	DO Ch#27	DO Ch#26	DO Ch#25	DO Ch#24

Data Description:

DO Ch#(0-31): When this bit is 1, the corresponding channel output signal is valid, the output is high level, and the output is invalid when it is 0.

0: Output signal is invalid

1: Output signal is valid

6 Configuration Parameter Definition

Configure parameters								
Bit No	Bit 7	Bit 6	Bit 5	Bit 4	Bit 3	Bit 2	Bit 1	Bit 0
Byte 0	Fault ACTION for Output Ch#7	Fault ACTION for Output Ch#6	Fault ACTION for Output Ch#5	Fault ACTION for Output Ch#4	Fault ACTION for Output Ch#3	Fault ACTION for Output Ch#2	Fault ACTION for Output Ch#1	Fault ACTION for Output Ch#0
Byte 1	Fault ACTION for Output Ch#15	Fault ACTION for Output Ch#14	Fault ACTION for Output Ch#13	Fault ACTION for Output Ch#12	Fault ACTION for Output Ch#11	Fault ACTION for Output Ch#10	Fault ACTION for Output Ch#9	Fault ACTION for Output Ch#8
Byte 2	Fault ACTION for Output Ch#23	Fault ACTION for Output Ch#22	Fault ACTION for Output Ch#21	Fault ACTION for Output Ch#20	Fault ACTION for Output Ch#19	Fault ACTION for Output Ch#18	Fault ACTION for Output Ch#17	Fault ACTION for Output Ch#16
Byte 3	Fault ACTION for Output Ch#31	Fault ACTION for Output Ch#30	Fault ACTION for Output Ch#29	Fault ACTION for Output Ch#28	Fault ACTION for Output Ch#27	Fault ACTION for Output Ch#26	Fault ACTION for Output Ch#25	Fault ACTION for Output Ch#24

Byte 4	Fault Value for Output Ch#7	Fault Value for Output Ch#6	Fault Value for Output Ch#5	Fault Value for Output Ch#4	Fault Value for Output Ch#3	Fault Value for Output Ch#2	Fault Value for Output Ch#1	Fault Value for Output Ch#0
Byte 5	Fault Value for Output Ch#15	Fault Value for Output Ch#14	Fault Value for Output Ch#13	Fault Value for Output Ch#12	Fault Value for Output Ch#11	Fault Value for Output Ch#10	Fault Value for Output Ch#9	Fault Value for Output Ch#8
Byte 6	Fault Value for Output Ch#23	Fault Value for Output Ch#22	Fault Value for Output Ch#21	Fault Value for Output Ch#20	Fault Value for Output Ch#19	Fault Value for Output Ch#18	Fault Value for Output Ch#17	Fault Value for Output Ch#16
Byte 7	Fault Value for Output Ch#31	Fault Value for Output Ch#30	Fault Value for Output Ch#29	Fault Value for Output Ch#28	Fault Value for Output Ch#27	Fault Value for Output Ch#26	Fault Value for Output Ch#25	Fault Value for Output Ch#24

Data description:

Fault Action for Output Ch#(0-31): Fault Output mode. When the IO module detects an internal bus exception and fails to communicate with the adapter. And the module will turn to offline mode, so the output data will be processed in this way. (default: 0)

0: keep the last time output State.

1: output fault value.

Fault Value for Output Ch#(0-31): When the Fault Output mode is 1, this bit sets the Fault Output Value, and this setting value will be outputted when the internal bus of IO module is offline. (default: 0)

0: Output low level.

1: Output high level.

A Dimensional drawing

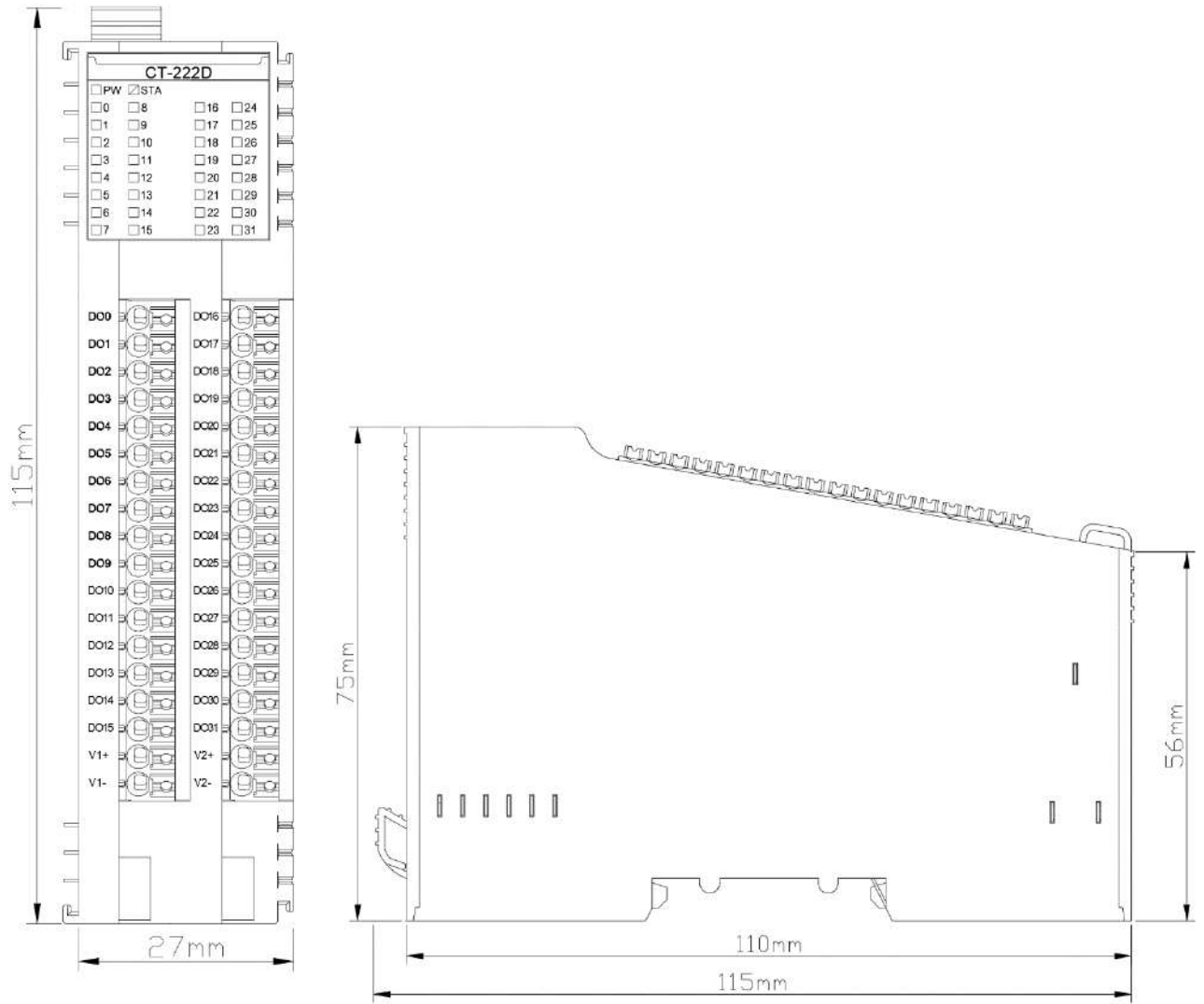

CT-221F 16 channels digital output/24VDC/NPN

1 Module features

- ◆ The module supports 16 channels digital output, the output voltage is 0V and the output low level is valid.
- ◆ The module can drive field equipment (relay, solenoid valve, etc.)
- ◆ The internal bus and field output of the module both adopt electromagnetic isolation
- ◆ The module carries 16 digital output channel LED indicator
- ◆ The module has the function of thermal shutdown and over current protection

2 Technical parameters

General Parameters	
Power	Max.75mA@5.0VDC
Isolation	I/O to internal bus: opto-couple isolation (3KVrms)
Field Power	Nominal:24VDC, Range:20.4-28.8VDC
VCLAMP Voltage	Nominal:24VDC, Input range:12-36VDC
Wiring	Max.: AWG 18 Min.: AWG 24
Installation	35mm DIN-Rail
Size	115*14*75mm
Weight	65g
Environment Specification	
Operating Temperature of Horizontal Installation	-35°C~70°C
Operating Temperature of Vertical Installation	-35°C~60°C
Relative Humidity	< 95%RH (No Condensation)
Storage Temperature	-40°C~85°C
Storage Humidity	< 95%RH (No Condensation)
Manufacturing Test Temperature	-40°C~75°C
Ingress Protection Rating	IP20
Output Parameters	
Channel Number	16 channel sink type output
LED Indicator	16 channel output LED indicator
Rated Current	single channel output: Max.1000mA simultaneously output: Max.500mA
Leakage Current	Max. 10uA
On Resistance	Typical value: 500mΩ
Output Delay	OFF to ON: Max.100us ON to OFF: Max.150us
Protection Function	Over-temperature shut down: typical value 160°C Overcurrent protection: typical value 1.8A Short circuit protection: supported New hardware association protection: a group of 4 channels
Load type	General use and Resistive, Pilot Duty

 **WARNING**

UNEXPECTED EQUIPMENT OPERATION

Do not exceed any of the ratings specified in the environmental and electrical characteristics table.

Failure to follow instructions specified by the manufacturer may result in serious consequences such as death, personal injury, or damage to equipment since the protection provided by the equipment may be impaired.

 **AVERTISSEMENT**

FONCTIONNEMENT INATTENDU DE L'EQUIPEMENT

Ne dépassez aucune évaluation spécifiée dans le tableau de caractéristiques environnementales et électriques..

Le fait de ne pas suivre les instructions peut entraîner une défaillance de la protection fournie par l'équipement, ce qui peut entraîner des conséquences graves, comme des blessures ou des dommages à l'équipement.

3 Hardware interfaces

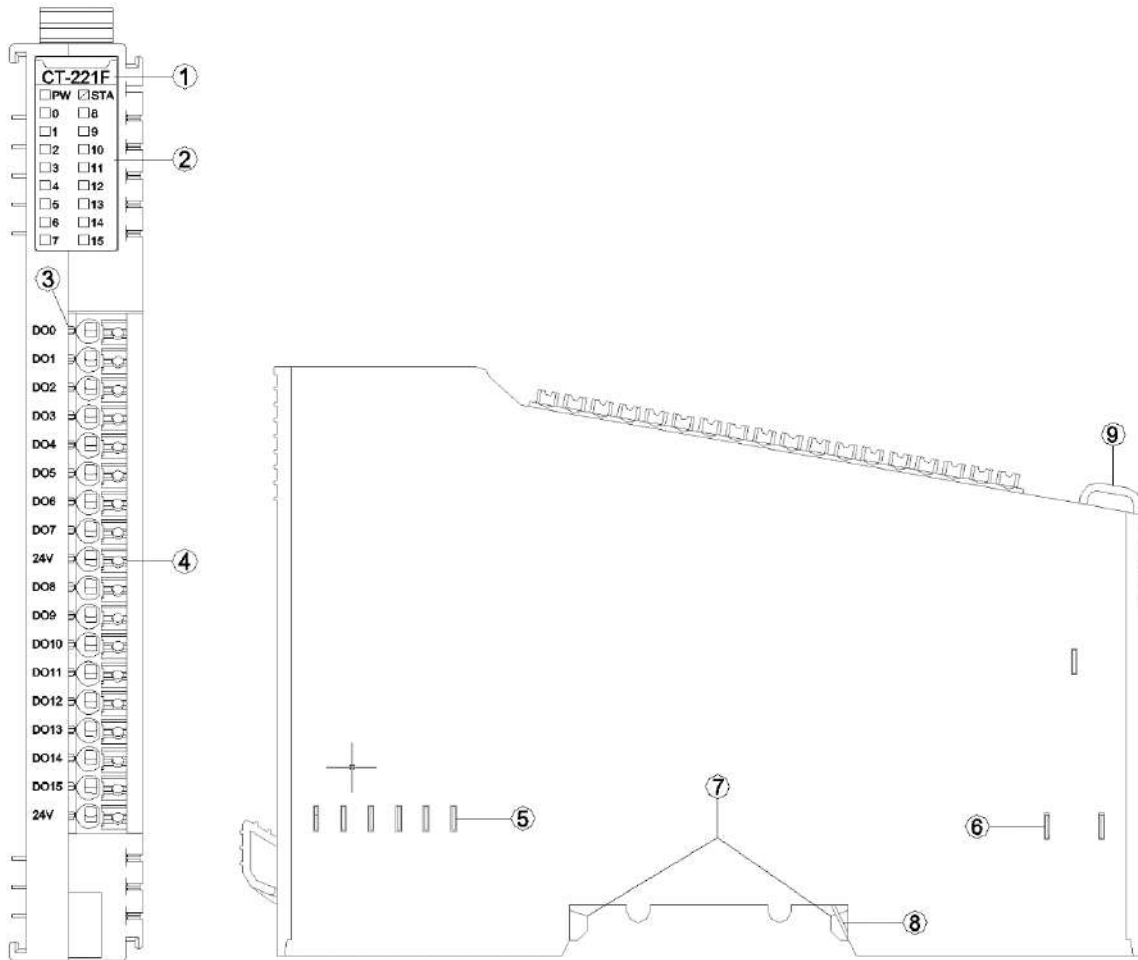

- ① Module Type
- ② State indicator
- ③ Channel indicator
- ④ Wiring Terminal and identification
- ⑤ Internal Bus
- ⑥ Field Power
- ⑦ Buckle
- ⑧ Grounding Spring Sheet
- ⑨ Fixed Wiring Harness

3.1 LED indicator definition

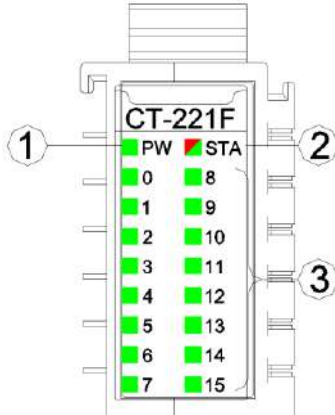

- ① Power LED indicator (green)
- ② Module State indicator LED (red/green)
- ③ Output channel indicator LED (green)

PW Power State	Definition
ON	Internal bus power supply normal
OFF	Internal bus power supply failure
STA Module State (RED/GREEN)	Definition
Green slow flash (2.5 Hz)	Module internal bus is not started
Red slow flash (2.5 Hz)	Module internal bus offline
ON (GREEN)	Operation normal
Flash (2.5 Hz) (RED/GREEN)	Updating mode
Flash (10 Hz) (RED/GREEN)	Firmware update
Double Flash (RED)	Module exception has been soft-restarted
0-15 channel indicator LED	Definition
ON	Output signal valid
OFF	Output signal invalid

⚠ WARNING

UNEXPECTED EQUIPMENT OPERATION

By viewing the PW indicator, could determine the power supply status of a module. If the PW is steady green, the power supply is normal. Otherwise, the module cannot work properly.

When the module is initially powered on, there will be 3S for the backplane bus connection. After the backplane bus is initialized, STA is in the green steady state. If STA is in the green blinking state, it indicates that the backplane bus has not been initialized, and it needs to be powered off and restarted for re-initialization.

STA abnormal working state occurs during the normal operation of the module, please check the firmware version information of all modules, and consult ODOT technical support for details.
If a module is upgraded, check that all modules are in the normal state after the upgrade. Otherwise, an exception may occur.

Failure to follow instructions specified by the manufacturer may result in serious consequences such as death, personal injury, or damage to equipment since the protection provided by the equipment may be impaired.

! A VERTISSEMENT

FONCTIONNEMENT INATTENDU DE L'EQUIPEMENT

En regardant l'état de l'indicateur de PW, jugez l'état d'alimentation du module. Le feu vert PW reste allumé et l'alimentation est normale. Autrement, le module ne fonctionnera pas correctement.

Lorsque le module est alimenté initialement, il y aura 3S pour la connexion de bus de backboard. STA est un état vert permanent après l'initialisation du bus de backboard. Si STA est en état de clignotement vert, cela signifie que l'initialisation du bus de backboard n'est pas passée et doit être redémarrée hors tension et réinitialisée.

L'état de fonctionnement anormal de STA se produit pendant le fonctionnement normal du module, veuillez vérifier les informations de version du firmware de tous les modules, et consulter le support technique ODOT pour plus de détails.

Si le module a une opération de mise à niveau, après l'achèvement de la mise à niveau, le besoin de vérifier que tous les modules sont dans l'état normal avant de courir, sinon il conduira à une exception.

Le fait de ne pas suivre les instructions peut entraîner une défaillance de la protection fournie par l'équipement, ce qui peut entraîner des conséquences graves, comme des blessures ou des dommages à l'équipement.

3.2 Field channel LED indicator (Green)

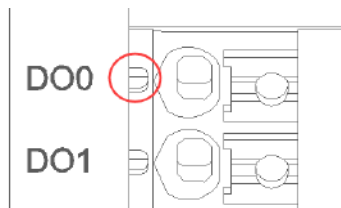

When output signal of output channel is valid, the corresponding field channel LED indicator is on.

3.3 Terminal definition

Terminal Number	Symbol	The Description
1	DO0	Signal output
2	DO1	
3	DO2	
4	DO3	
5	DO4	
6	DO5	
7	DO6	
8	DO7	
9	24V	Power input (Note1)
10	DO8	Signal output
11	DO9	
12	DO10	
13	DO11	
14	DO12	
15	DO13	
16	DO14	
17	DO15	
18	24V	Power input (Note1)

Note 1:

A: For non-V3.0 hardware versions, power input terminals 9 and 18 must be connected to a 24V power supply.

B: For the V3.0 hardware version, the "24V" interface on the CT-221F terminal is only used for continuous current. When connecting inductive load, the interface needs to be connected to the 24V of the field power supply. The indicator of the "24V" port on the CT-221F terminal is cancelled. See the wiring diagram for details.

WARNING

UNEXPECTED EQUIPMENT OPERATION

Calculate the maximum field power current consumption of a single module based on the actual field load. If the total field power current consumption of all I/O modules exceeds the power supply capacity of the field power supply, you must add an extra power expansion module. Otherwise, an output channel exception may occur.

Failure to follow instructions specified by the manufacturer may result in serious consequences such as death, personal injury, or damage to equipment since the protection provided by the equipment may be impaired.

⚠️ AVERTISSEMENT

FONCTIONNEMENT INATTENDU DE L'ÉQUIPEMENT

Calculez la consommation maximale de courant de champ d'un seul module en fonction de la charge de champ réelle. Si la consommation totale de courant de champ de tous les modules d'E/S dépasse la capacité d'alimentation de l'alimentation de champ, vous devez ajouter un module d'extension de puissance supplémentaire. Dans le cas contraire, une exception de canal de sortie peut se produire.

Le fait de ne pas suivre les instructions peut entraîner une défaillance de la protection fournie par l'équipement, ce qui peut entraîner des conséquences graves, comme des blessures ou des dommages à l'équipement.

When connecting a cold-pressed terminal, the terminal must be terminated and checked in strict accordance with the corresponding termination specifications or requirements, and connect the cold-pressed terminal according to the corresponding node serial number. The conductor should use copper conductor and the conductor core should be larger than 0.2mm^2 and smaller than 1mm^2 (AWG18~AWG24). Cold-pressed terminal parameters are as follows:

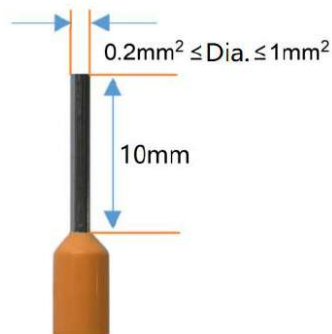

⚠️ WARNING

UNEXPECTED EQUIPMENT OPERATION

Strip the length of the conductor insulation layer is greater than 10mm to ensure reliable signal connection.

The wire needs to use copper wire and the wire core is greater than or equal to 0.2mm^2 and less than or equal to 1mm^2 to ensure reliable signal connection.

When connecting a cold-press terminal, connect the cold-press terminal strictly in accordance with the corresponding termination specifications or requirements, and connect the cold-press terminal according to the corresponding node serial number.

Do not power on cold-press terminals until they are properly connected or fully locked.

Failure to follow instructions specified by the manufacturer may result in serious consequences such as death, personal injury, or damage to equipment since the protection provided by the equipment may be impaired.

AVERTISSEMENT

FONCTIONNEMENT INATTENDU DE L'EQUIPEMENT

Dépouillez la longueur de la couche isolante du fil plus de 10mm pour assurer la connexion fiable du signal.

Le conducteur doit utiliser le fil de cuivre et le noyau de fil est supérieur ou égal à 0,2 mm², inférieur ou égal à 1mm², afin d'assurer la connexion fiable du signal.

Lorsque les terminaux de presse à froid sont terminés, ils doivent être terminés et visualisés en stricte conformité avec les spécifications ou les exigences correspondantes et terminés selon le numéro de série de noeud correspondant.

Il est interdit d'activer les bornes à froid avant qu'elles ne soient correctement articulées ou complètement verrouillées.

Le fait de ne pas suivre les instructions peut entraîner une défaillance de la protection fournie par l'équipement, ce qui peut entraîner des conséquences graves, comme des blessures ou des dommages à l'équipement.

DANGER

FIRE DANGER

Use the correct wiring rules only for the maximum current capacity of the I/O channel and power supply.

Failure to follow instructions specified by the manufacturer may result in serious consequences such as death, personal injury, or damage to equipment since the protection provided by the equipment may be impaired.

WARNING

UNEXPECTED EQUIPMENT OPERATION

Do not exceed any of the ratings specified in the environmental and electrical characteristics table.

Failure to follow instructions specified by the manufacturer may result in serious consequences such as death, personal injury, or damage to equipment since the protection provided by the equipment may be impaired.

AVERTISSEMENT

FONCTIONNEMENT INATTENDU DE L'EQUIPEMENT

Ne dépassez aucune évaluation spécifiée dans le tableau de caractéristiques environnementales et électriques..

Le fait de ne pas suivre les instructions peut entraîner une défaillance de la protection fournie par l'équipement, ce qui peut entraîner des conséquences graves, comme des blessures ou des dommages à l'équipement.

4 Wiring

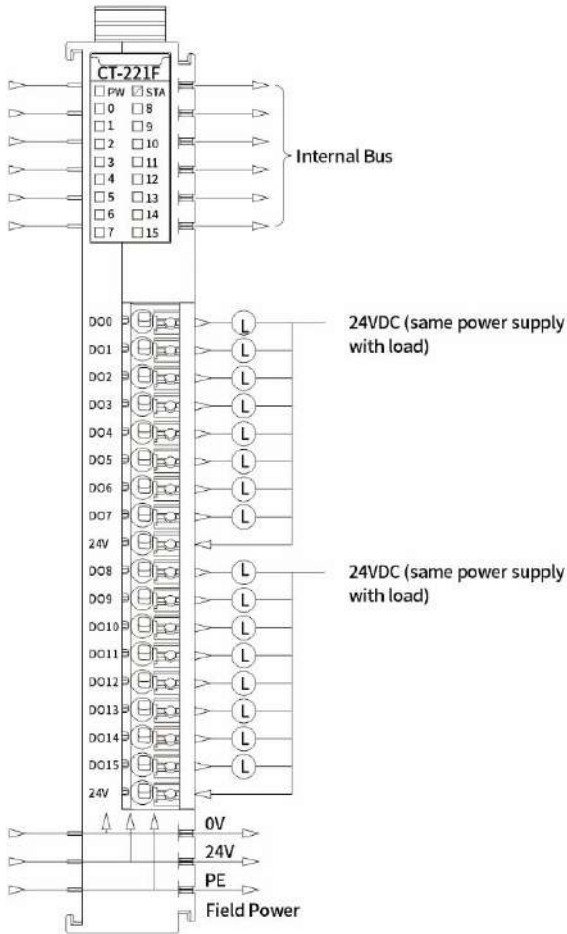

Figure 1, Non-V3.0 hardware version

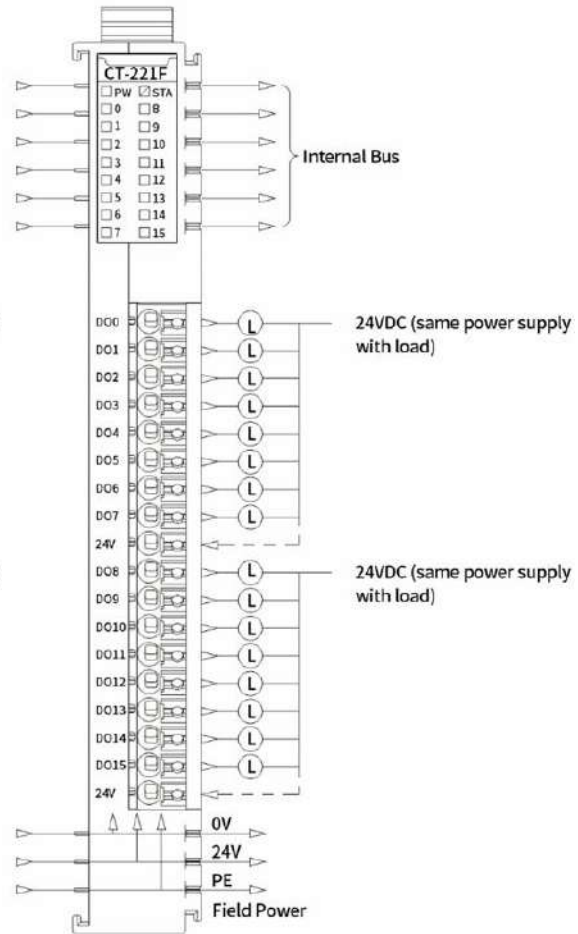

Figure 2, V3.0 hardware version

NOTICE

EQUIPMENT INOPERABLE

Do not crimp the spring terminal with more than the maximum pressure specified for the terminal. Otherwise, the resilience of the spring terminal may be damaged and the terminal rebound may be affected.

Do not press the spring terminal with a sharp tool when removing cable from the channel. Otherwise, the spring terminal will be damaged.

Failure to follow these instructions may result in equipment damage.

5 Process data definition

Output data								
Bit No	Bit 7	Bit 6	Bit 5	Bit 4	Bit 3	Bit 2	Bit 1	Bit 0
Byte 0	DO Ch#7	DO Ch#6	DO Ch#5	DO Ch#4	DO Ch#3	DO Ch#2	DO Ch#1	DO Ch#0
Byte 1	DO Ch#15	DO Ch#14	DO Ch#13	DO Ch#12	DO Ch#11	DO Ch#10	DO Ch#9	DO Ch#8

Data description:

DO Ch#(0-15): when this bit is 1, the corresponding channel output signal is valid, the output is low level, and the output is invalid when it is 0.

0: Output signal is invalid

1: Output signal is valid

6 Configuration parameter definitions

Configuration parameters								
Bit No	Bit 7	Bit 6	Bit 5	Bit 4	Bit 3	Bit 2	Bit 1	Bit 0
Byte 0	Fault Action for Output Ch#7	Fault Action for Output Ch#6	Fault Action for Output Ch#5	Fault Action for Output Ch#4	Fault Action for Output Ch#3	Fault Action for Output Ch#2	Fault Action for Output Ch#1	Fault Action for Output Ch#0
Byte 1	Fault Action for Output Ch#15	Fault Action for Output Ch#14	Fault Action for Output Ch#13	Fault Action for Output Ch#12	Fault Action for Output Ch#11	Fault Action for Output Ch#10	Fault Action for Output Ch#9	Fault Action for Output Ch#8
Byte 2	Fault Value for Output Ch#7	Fault Value for Output Ch#6	Fault Value for Output Ch#5	Fault Value for Output Ch#4	Fault Value for Output Ch#3	Fault Value for Output Ch#2	Fault Value for Output Ch#1	Fault Value for Output Ch#0
Byte 3	Fault Value for Output Ch#15	Fault Value for Output Ch#14	Fault Value for Output Ch#13	Fault Value for Output Ch#12	Fault Value for Output Ch#11	Fault Value for Output Ch#10	Fault Value for Output Ch#9	Fault Value for Output Ch#8

Data description:

Fault Action for Output Ch#(0-15): Fault Output mode. When the IO module detects an internal bus exception and fails to communicate with the adapter. And the module will turn to offline mode, so the output data is processed in this way. (default: 0)

0: keep the last time output State.

1: output fault value.

Fault Value for Output Ch#(0-15): when the Fault Output mode is 1, this bit sets the Fault Output Value, and this setting value will be outputted when the internal bus of IO module is offline. (default: 0)

0: Output low level.

1: Output high level.

A Dimension drawing

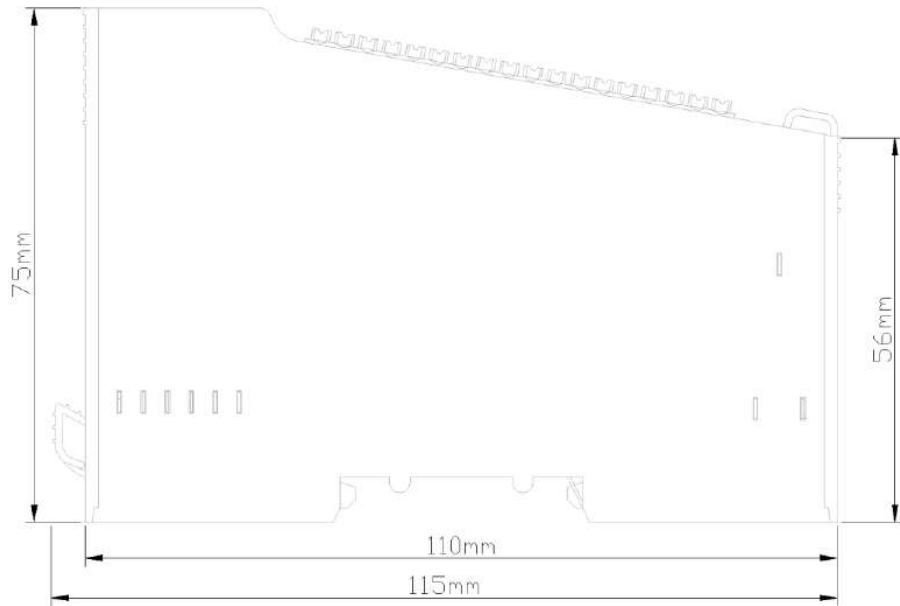
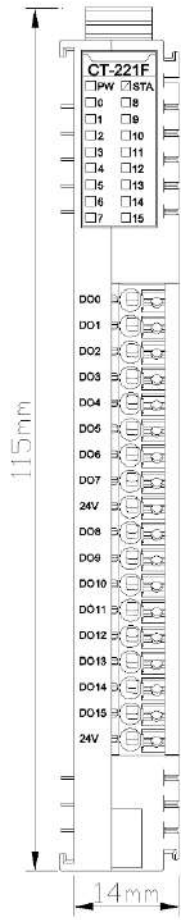

CT-221H 32 channels digital output/24VDC/NPN

1 Module features

- ◆ The module supports 32 channels digital output, the output voltage is 0V and the output low level is valid.
- ◆ The module can drive field equipment (relay, solenoid valve, etc.)
- ◆ The internal bus and field output of the module both adopt electromagnetic isolation
- ◆ The module carries 32 digital output channel LED indicator
- ◆ The module has the function of thermal shutdown and over current protection

2 Technical parameters

General Parameters	
Power	Max.175mA@5.0VDC
Isolation	I/O to internal bus: opto-couple isolation (3KVrms)
Field Power	Nominal:24VDC, Range:20.4-28.8VDC
VCLAMP Voltage	Nominal:24VDC, Input range:12-36VDC
Wiring	Max.: AWG 18 Min.: AWG 24
Installation	35mm DIN-Rail
Size	115*14*75mm
Weight	65g
Environment Specification	
Operating Temperature of Horizontal Installation	-35°C~70°C
Operating Temperature of Vertical Installation	-35°C~60°C
Relative Humidity	< 95%RH (No Condensation)
Storage Temperature	-40°C~85°C
Storage Humidity	< 95%RH (No Condensation)
Manufacturing Test Temperature	-40°C~75°C
Ingress Protection Rating	IP20
Output Parameters	
Channel Number	32 channel sink type output
LED Indicator	32 channel output LED indicator
Rated Current	single channel output: Max.1000mA 16 channels simultaneously output: Max.500mA 32 channels simultaneously output: Max.300mA
Leakage Current	Max. 10uA
On Resistance	Typical value: 500mΩ
Output Delay	OFF to ON: Max.100us ON to OFF: Max.150us
Protection Function	Over-temperature shut down: typical value 160°C Overcurrent protection: typical value 1.8A Short circuit protection: supported Association protection: a group of 4 channels
Load type	General use and Resistive, Pilot Duty

 **WARNING**

UNEXPECTED EQUIPMENT OPERATION

Do not exceed any of the ratings specified in the environmental and electrical characteristics table.

Failure to follow instructions specified by the manufacturer may result in serious consequences such as death, personal injury, or damage to equipment since the protection provided by the equipment may be impaired.

 **AVERTISSEMENT**

FONCTIONNEMENT INATTENDU DE L'EQUIPEMENT

Ne dépassez aucune évaluation spécifiée dans le tableau de caractéristiques environnementales et électriques..

Le fait de ne pas suivre les instructions peut entraîner une défaillance de la protection fournie par l'équipement, ce qui peut entraîner des conséquences graves, comme des blessures ou des dommages à l'équipement.

3 Hardware interfaces

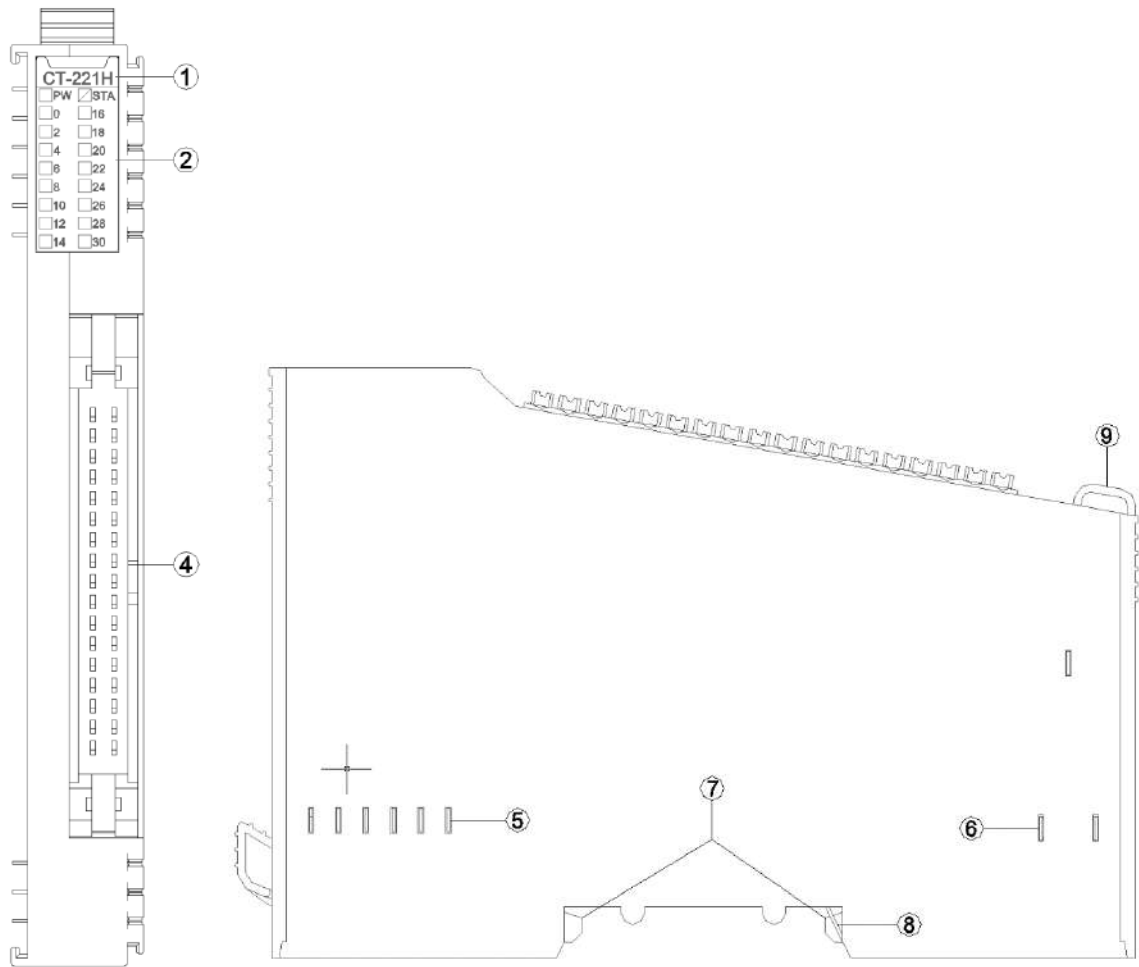

- ① Module Type
- ② State indicator
- ③ N/A
- ④ Wiring Terminal and identification
- ⑤ Internal Bus
- ⑥ Field Power
- ⑦ Buckle
- ⑧ Grounding Spring Sheet
- ⑨ Fixed Wiring Harness

3.1 LED indicator definition

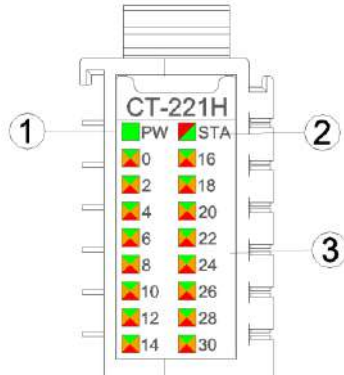

- ① Power LED indicator (green)
- ② Module State indicator LED (red/green)
- ③ Output channel indicator LED (red/green/orange)

PW Power State	Definition
ON	Internal bus power supply normal
OFF	Internal bus power supply failure
STA Module State (RED/GREEN)	Definition
Green slow flash (2.5 Hz)	Module internal bus is not started
Red slow flash (2.5 Hz)	Module internal bus offline
ON (GREEN)	Operation normal
Flash (2.5 Hz) (RED/GREEN)	Updating mode
Flash (10 Hz) (RED/GREEN)	Firmware update
Double Flash (RED)	Module exception has been soft-restarted
0-31 channel indicator LED (Red/Green/Orange)	Definition
ON (Green)	Indicates that the output channel signal is valid
ON (Red)	Indicates that the output channel +1 signal is valid
ON (Orange)	Indicates that the output channel and channel +1 signal are valid
OFF	Output signal is invalid

⚠ WARNING

UNEXPECTED EQUIPMENT OPERATION

By viewing the PW indicator, could determine the power supply status of a module. If the PW is steady green, the power supply is normal. Otherwise, the module cannot work properly.

When the module is initially powered on, there will be 3S for the backplane bus connection. After the backplane bus is initialized, STA is in the green steady state. If STA is in the green blinking

state, it indicates that the backplane bus has not been initialized, and it needs to be powered off and restarted for re-initialization.

STA abnormal working state occurs during the normal operation of the module, please check the firmware version information of all modules, and consult ODOT technical support for details.

If a module is upgraded, check that all modules are in the normal state after the upgrade. Otherwise, an exception may occur.

Failure to follow instructions specified by the manufacturer may result in serious consequences such as death, personal injury, or damage to equipment since the protection provided by the equipment may be impaired.

A VERTISSEMENT

FONCTIONNEMENT INATTENDU DE L'EQUIPEMENT

En regardant l'état de l'indicateur de PW, jugez l'état d'alimentation du module. Le feu vert PW reste allumé et l'alimentation est normale. Autrement, le module ne fonctionnera pas correctement.

Lorsque le module est alimenté initialement, il y aura 3S pour la connexion de bus de backboard. STA est un état vert permanent après l'initialisation du bus de backboard. Si STA est en état de clignotement vert, cela signifie que l'initialisation du bus de backboard n'est pas passée et doit être redémarrée hors tension et réinitialisée.

L'état de fonctionnement anormal de STA se produit pendant le fonctionnement normal du module, veuillez vérifier les informations de version du firmware de tous les modules, et consulter le support technique ODOT pour plus de détails.

Si le module a une opération de mise à niveau, après l'achèvement de la mise à niveau, le besoin de vérifier que tous les modules sont dans l'état normal avant de courir, sinon il conduira à une exception.

Le fait de ne pas suivre les instructions peut entraîner une défaillance de la protection fournie par l'équipement, ce qui peut entraîner des conséquences graves, comme des blessures ou des dommages à l'équipement.

3.2 Terminal definition

Description	Symbol	Terminal Number	Terminal Number	Symbol	Description
Signal Output	DO0	1	18	DO16	Signal Output
	DO1	2	19	DO17	
	DO2	3	20	DO18	
	DO3	4	21	DO19	
	DO4	5	22	DO20	
	DO5	6	23	DO21	
	DO6	7	24	DO22	
	DO7	8	25	DO23	
	DO8	9	26	DO24	
	DO9	10	27	DO25	
	DO10	11	28	DO26	
	DO11	12	29	DO27	
	DO12	13	30	DO28	
	DO13	14	31	DO29	
	DO14	15	32	DO30	
DO15	16	33	DO31		
24V	24V	17	34	24V	24V

Pins 17 and 34 are internally short-circuited.

3.3 External terminal block

Module number	MTC034	MTE034
Name	Scre terminal block	Spring terminal block
Suitable cable	DX210-3SFX-2000	
Nominal current	1A	
Nominal voltage	DC24V	
Wiring	Max. AWG 18	

MTE034

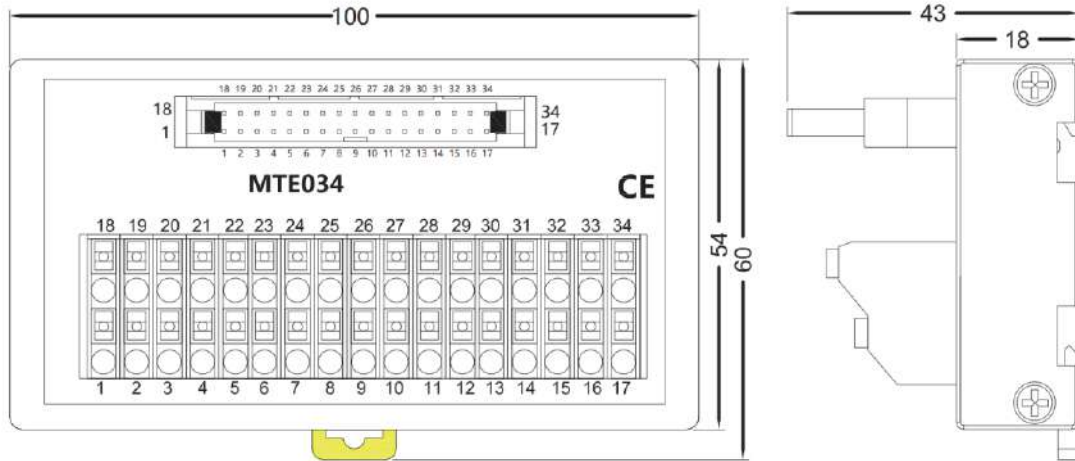

MTC034

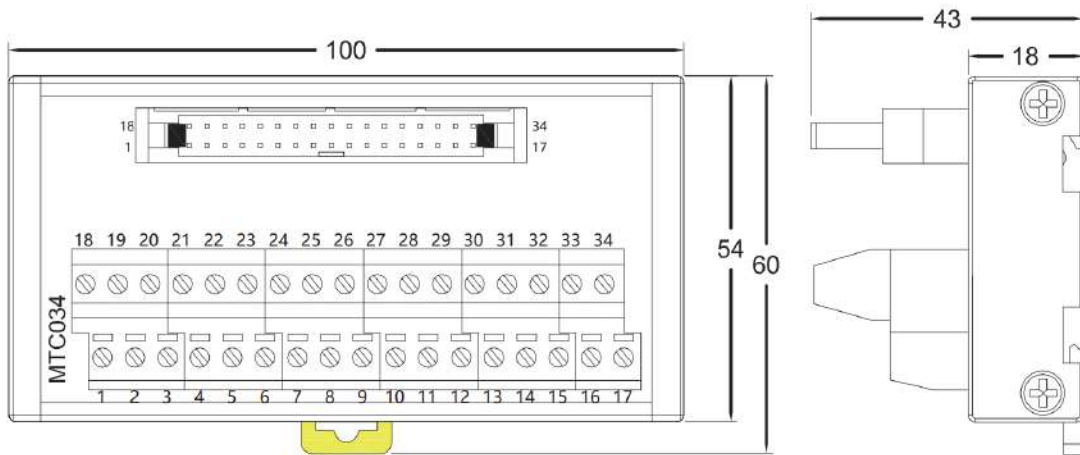

4 Wiring

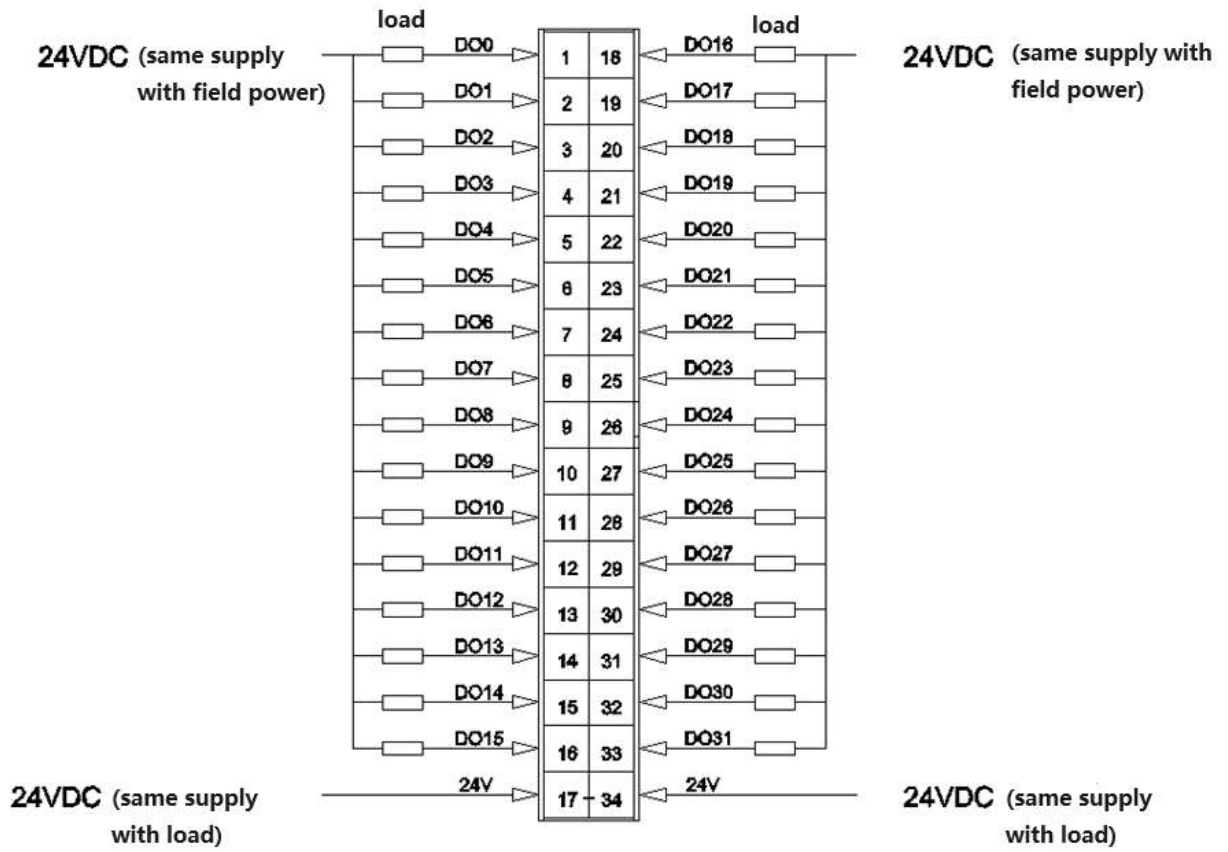

Pins 17 and 34 are internally short-circuited

5 Process data definition

Output data								
Bit No	Bit 7	Bit 6	Bit 5	Bit 4	Bit 3	Bit 2	Bit 1	Bit 0
Byte 0	DO Ch#7	DO Ch#6	DO Ch#5	DO Ch#4	DO Ch#3	DO Ch#2	DO Ch#1	DO Ch#0
Byte 1	DO Ch#15	DO Ch#14	DO Ch#13	DO Ch#12	DO Ch#11	DO Ch#10	DO Ch#9	DO Ch#8

Data description:

DO Ch#(0-31): when this bit is 1, the corresponding channel output signal is valid, the output is low level, and the output is invalid when it is 0.

0: Output signal is invalid

1: Output signal is valid

6 Configuration parameter definitions

Configuration parameters								
Bit No	Bit 7	Bit 6	Bit 5	Bit 4	Bit 3	Bit 2	Bit 1	Bit 0
Byte 0	Fault Action for Output Ch#7	Fault Action for Output Ch#6	Fault Action for Output Ch#5	Fault Action for Output Ch#4	Fault Action for Output Ch#3	Fault Action for Output Ch#2	Fault Action for Output Ch#1	Fault Action for Output Ch#0
Byte 1	Fault Action for Output Ch#15	Fault Action for Output Ch#14	Fault Action for Output Ch#13	Fault Action for Output Ch#12	Fault Action for Output Ch#11	Fault Action for Output Ch#10	Fault Action for Output Ch#9	Fault Action for Output Ch#8
Byte 2	Fault Action for Output Ch#23	Fault Action for Output Ch#22	Fault Action for Output Ch#21	Fault Action for Output Ch#20	Fault Action for Output Ch#19	Fault Action for Output Ch#18	Fault Action for Output Ch#17	Fault Action for Output Ch#16
Byte 3	Fault Action for Output Ch#31	Fault Action for Output Ch#30	Fault Action for Output Ch#29	Fault Action for Output Ch#28	Fault Action for Output Ch#27	Fault Action for Output Ch#26	Fault Action for Output Ch#25	Fault Action for Output Ch#24
Byte 4	Fault Value for Output Ch#7	Fault Value for Output Ch#6	Fault Value for Output Ch#5	Fault Value for Output Ch#4	Fault Value for Output Ch#3	Fault Value for Output Ch#2	Fault Value for Output Ch#1	Fault Value for Output Ch#0

Byte 5	Fault Value for Output Ch#15	Fault Value for Output Ch#14	Fault Value for Output Ch#13	Fault Value for Output Ch#12	Fault Value for Output Ch#11	Fault Value for Output Ch#10	Fault Value for Output Ch#9	Fault Value for Output Ch#8
Byte 6	Fault Value for Output Ch#23	Fault Value for Output Ch#22	Fault Value for Output Ch#21	Fault Value for Output Ch#20	Fault Value for Output Ch#19	Fault Value for Output Ch#18	Fault Value for Output Ch#17	Fault Value for Output Ch#16
Byte 7	Fault Value for Output Ch#31	Fault Value for Output Ch#30	Fault Value for Output Ch#29	Fault Value for Output Ch#28	Fault Value for Output Ch#27	Fault Value for Output Ch#26	Fault Value for Output Ch#25	Fault Value for Output Ch#24

Data description:

Fault Action for Output Ch#(0-31): Fault Output mode. When the IO module detects an internal bus exception and fails to communicate with the adapter. And the module will turn to offline mode, so the output data is processed in this way. (default: 0)

0: keep the last time output State.

1: output fault value.

Fault Value for Output Ch#(0-31): when the Fault Output mode is 1, this bit sets the Fault Output Value, and this setting value will be outputted when the internal bus of IO module is offline. (default: 0)

0: Output low level.

1: Output high level.

A Dimension drawing

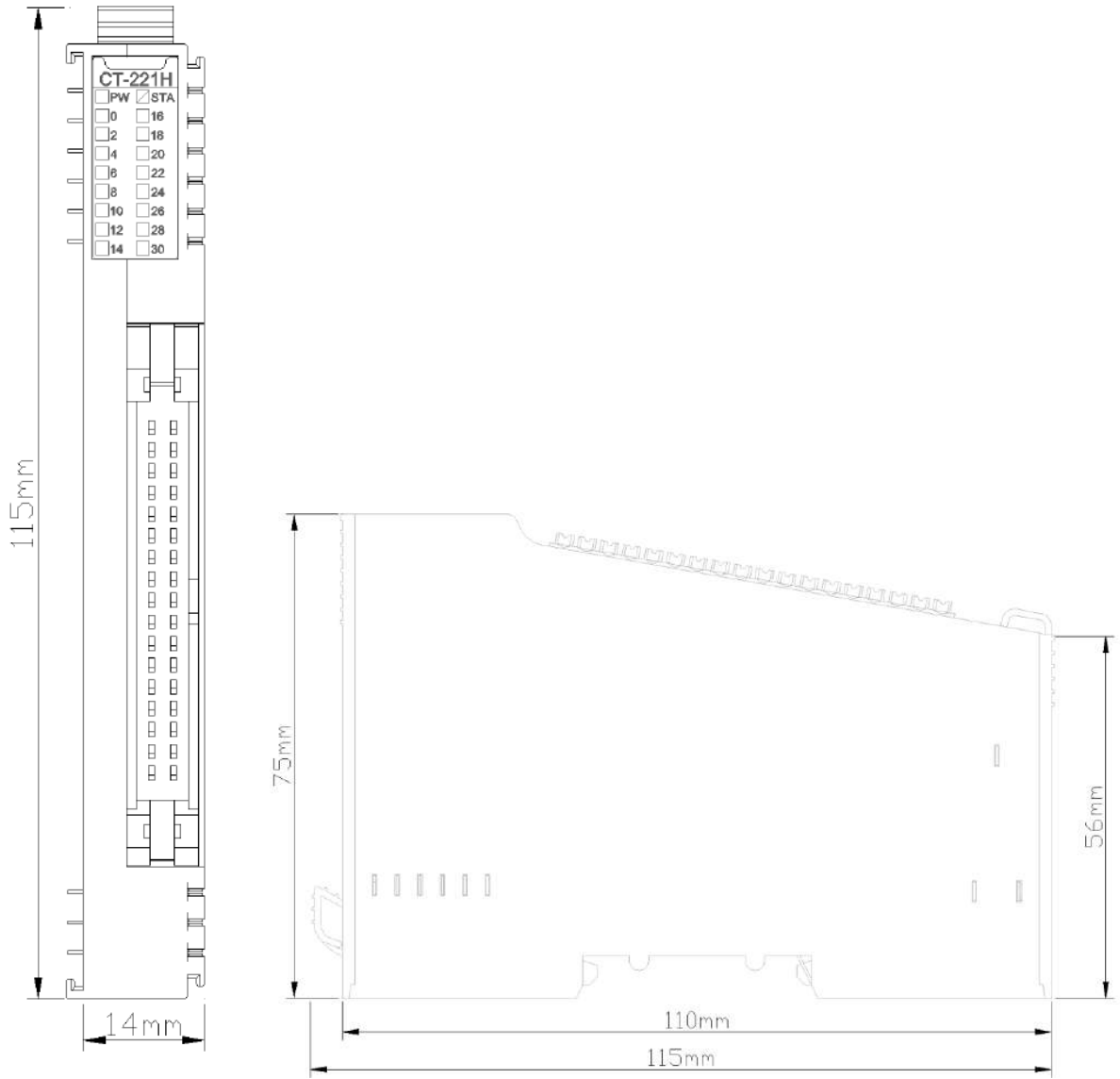

CT-221D 32 channels digital output/24VDC/NPN

1 Module features

- ◆ The module supports 32 channels digital output, the output voltage is 0V and the output low level is valid.
- ◆ The module can drive field equipment (relay, solenoid valve, etc.)
- ◆ The internal bus of the module and field output are using opto-coupler.
- ◆ The module carries 32 digital output channel LED indicator
- ◆ The module has the function of thermal shutdown and over current protection
- ◆ The module supports short circuit protection and overload protection

2 Technical parameters

General Parameters	
Power	Max.120mA@5.0VDC
Isolation	The isolation voltage between the I/O channel and the system power supply: AC500V The isolation voltage between the I/O channel and the field power supply: AC500V Isolation voltage between the I/O channel and PE: AC 500V
Field Power	Nominal:24VDC, Range:20.4-28.8VDC
VCLAMP Voltage	Nominal:24VDC, Input range:12-36VDC
Wiring	Max.: AWG 18 Min.: AWG 24
Installation	35mm DIN-Rail
Size	115*14*75mm
Weight	130g
Environment Specification	
Operating Temperature of Horizontal Installation	-35°C~70°C
Operating Temperature of Vertical Installation	-35°C~60°C
Relative Humidity	< 95%RH (No Condensation)
Storage Temperature	-40°C~85°C
Storage Humidity	< 95%RH (No Condensation)
Manufacturing Test Temperature	-40°C~75°C
Ingress Protection Rating	IP20
Output Parameters	
Channel Number	32 channel sink type output
LED Indicator	32 channel output LED indicator
Rated Current	single channel output: Max.1500mA simultaneously output: Max.500mA
Leakage Current	Max. 5uA
On Resistance	Typical value: 260mΩ
Output Delay	OFF to ON: Max.100us ON to OFF: Max.150us
Protection Function	Over-temperature shut down: typical value 160°C Overcurrent protection: typical value 1.8A Short circuit protection: supported Channel independent protection
Load type	General use and Resistive, Pilot Duty
EMC parameters	
Static Electricity	Air 8KV/ Contact 6KV`
EFT	2KV
Surge	2KV

 **WARNING**

UNEXPECTED EQUIPMENT OPERATION

Do not exceed any of the ratings specified in the environmental and electrical characteristics table.

Failure to follow instructions specified by the manufacturer may result in serious consequences such as death, personal injury, or damage to equipment since the protection provided by the equipment may be impaired.

 **AVERTISSEMENT**

FONCTIONNEMENT INATTENDU DE L'EQUIPEMENT

Ne dépassez aucune évaluation spécifiée dans le tableau de caractéristiques environnementales et électriques..

Le fait de ne pas suivre les instructions peut entraîner une défaillance de la protection fournie par l'équipement, ce qui peut entraîner des conséquences graves, comme des blessures ou des dommages à l'équipement.

3 Hardware interfaces

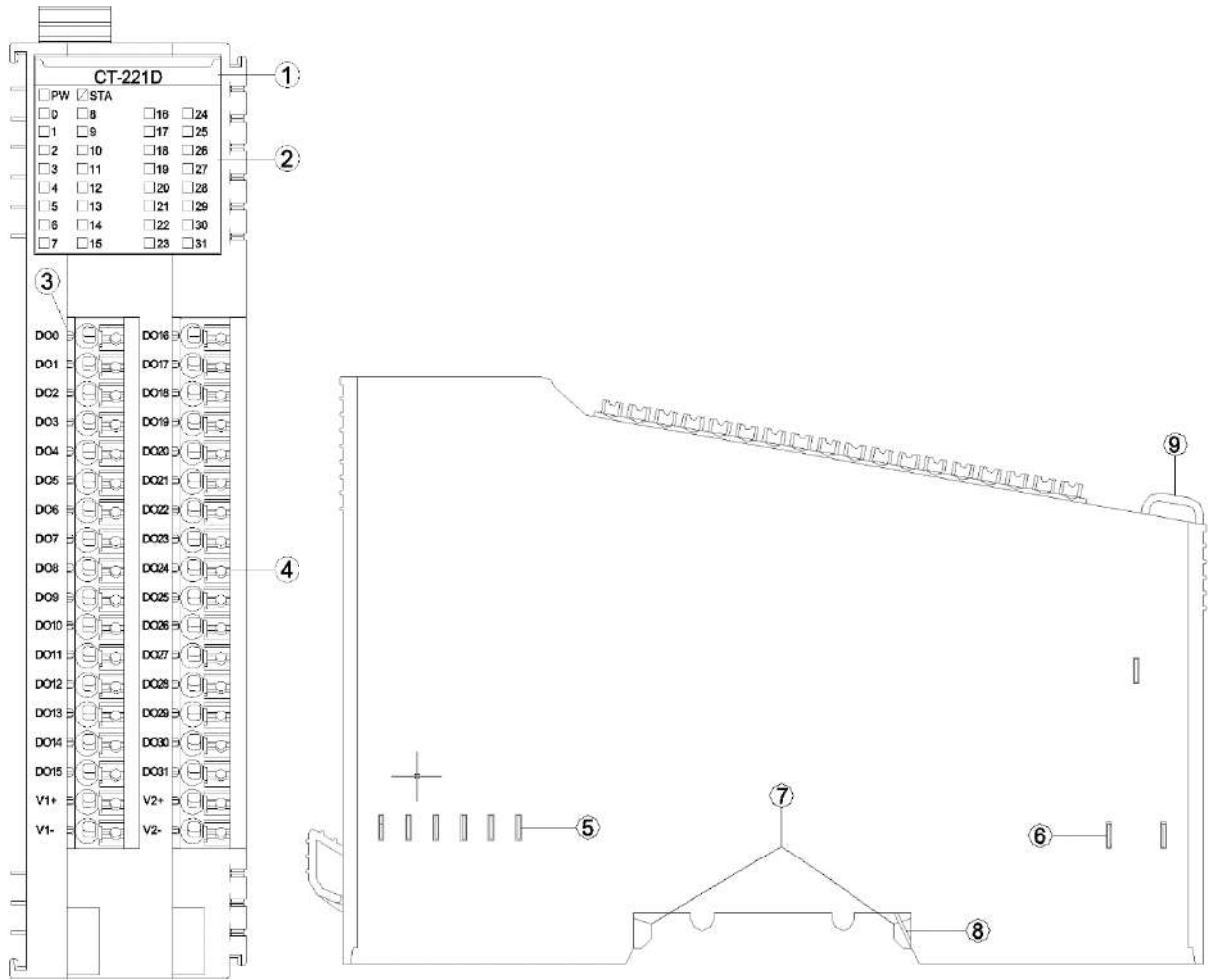

- ① Module Type
- ② State indicator
- ③ Channel indicator
- ④ Wiring Terminal and identification
- ⑤ Internal Bus
- ⑥ Field Power
- ⑦ Buckle
- ⑧ Grounding Spring Sheet
- ⑨ Fixed Wiring Harness

3.1 LED indicator definition

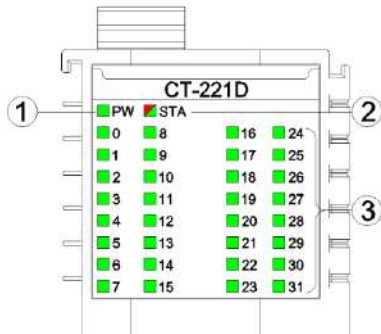

- ① Power LED indicator (green)
- ② Module State indicator LED (red/green)
- ③ Output channel indicator LED (green)

PW Power State	Definition
ON	Internal bus power supply normal
OFF	Internal bus power supply failure
STA Module State (RED/GREEN)	Definition
Green slow flash (2.5 Hz)	Module internal bus is not started
Red slow flash (2.5 Hz)	Module internal bus offline
ON (GREEN)	Operation normal
Flash (2.5 Hz) (RED/GREEN)	Updating mode
Flash (10 Hz) (RED/GREEN)	Firmware update
Double Flash (RED)	Module exception has been soft-restarted
0-31 channel indicator LED (Green)	Definition
ON	Output signal is valid
OFF	Output signal is invalid

⚠️ WARNING

UNEXPECTED EQUIPMENT OPERATION

By viewing the PW indicator, could determine the power supply status of a module. If the PW is steady green, the power supply is normal. Otherwise, the module cannot work properly.

When the module is initially powered on, there will be 3S for the backplane bus connection. After the backplane bus is initialized, STA is in the green steady state. If STA is in the green blinking state, it indicates that the backplane bus has not been initialized, and it needs to be powered off and restarted for re-initialization.

STA abnormal working state occurs during the normal operation of the module, please check the

firmware version information of all modules, and consult ODOT technical support for details.
If a module is upgraded, check that all modules are in the normal state after the upgrade.
Otherwise, an exception may occur.

Failure to follow instructions specified by the manufacturer may result in serious consequences such as death, personal injury, or damage to equipment since the protection provided by the equipment may be impaired.

AVERTISSEMENT

FONCTIONNEMENT INATTENDU DE L'ÉQUIPEMENT

En regardant l'état de l'indicateur de PW, jugez l'état d'alimentation du module. Le feu vert PW reste allumé et l'alimentation est normale. Autrement, le module ne fonctionnera pas correctement.

Lorsque le module est alimenté initialement, il y aura 3S pour la connexion de bus de backboard. STA est un état vert permanent après l'initialisation du bus de backboard. Si STA est en état de clignotement vert, cela signifie que l'initialisation du bus de backboard n'est pas passée et doit être redémarrée hors tension et réinitialisée.

L'état de fonctionnement anormal de STA se produit pendant le fonctionnement normal du module, veuillez vérifier les informations de version du firmware de tous les modules, et consulter le support technique ODOT pour plus de détails.

Si le module a une opération de mise à niveau, après l'achèvement de la mise à niveau, le besoin de vérifier que tous les modules sont dans l'état normal avant de courir, sinon il conduira à une exception.

Le fait de ne pas suivre les instructions peut entraîner une défaillance de la protection fournie par l'équipement, ce qui peut entraîner des conséquences graves, comme des blessures ou des dommages à l'équipement.

3.2 Terminal definition

Description	Symbol	Terminal Number	Terminal Number	Symbol	Description
Signal Output	DO0	1	18	DO16	Signal Output
	DO1	2	19	DO17	
	DO2	3	20	DO18	
	DO3	4	21	DO19	
	DO4	5	22	DO20	
	DO5	6	23	DO21	
	DO6	7	24	DO22	
	DO7	8	25	DO23	
	DO8	9	26	DO24	
	DO9	10	27	DO25	
	DO10	11	28	DO26	
	DO11	12	29	DO27	
	DO12	13	30	DO28	
	DO13	14	31	DO29	
	DO14	15	32	DO30	
DO15	16	33	DO31		
24V	V1+	17	35	V2+	24V
0V	V1-	18	36	V2-	0V

WARNING

UNEXPECTED EQUIPMENT OPERATION

Calculate the maximum field power current consumption of a single module based on the actual field load. If the total field power current consumption of all I/O modules exceeds the power supply capacity of the field power supply, you must add an extra power expansion module. Otherwise, an output channel exception may occur.

Failure to follow instructions specified by the manufacturer may result in serious consequences such as death, personal injury, or damage to equipment since the protection provided by the equipment may be impaired.

AVERTISSEMENT

FONCTIONNEMENT INATTENDU DE L'EQUIPEMENT

Calculez la consommation maximale de courant de champ d'un seul module en fonction de la charge de champ réelle. Si la consommation totale de courant de champ de tous les modules d'E/S dépasse la capacité d'alimentation de l'alimentation de champ, vous devez ajouter un module d'extension de puissance supplémentaire. Dans le cas contraire, une exception de canal de sortie peut se produire.

Le fait de ne pas suivre les instructions peut entraîner une défaillance de la protection fournie par l'équipement, ce qui peut entraîner des conséquences graves, comme des blessures ou des dommages à l'équipement.

When connecting a cold-pressed terminal, the terminal must be terminated and checked in strict accordance with the corresponding termination specifications or requirements, and connect the cold-pressed terminal according to the corresponding node serial number. The conductor should use copper conductor and the conductor core should be larger than 0.2mm^2 and smaller than 1mm^2 (AWG18~AWG24). Cold-pressed terminal parameters are as follows:



! WARNING

UNEXPECTED EQUIPMENT OPERATION

Strip the length of the conductor insulation layer is greater than 10mm to ensure reliable signal connection.

The wire needs to use copper wire and the wire core is greater than or equal to 0.2mm^2 and less than or equal to 1mm^2 to ensure reliable signal connection.

When connecting a cold-press terminal, connect the cold-press terminal strictly in accordance with the corresponding termination specifications or requirements, and connect the cold-press terminal according to the corresponding node serial number.

Do not power on cold-press terminals until they are properly connected or fully locked.

Failure to follow instructions specified by the manufacturer may result in serious consequences such as death, personal injury, or damage to equipment since the protection provided by the equipment may be impaired.

! AVERTISSEMENT

FONCTIONNEMENT INATTENDU DE L'EQUIPEMENT

Dépouillez la longueur de la couche isolante du fil plus de 10mm pour assurer la connexion fiable du signal.

Le conducteur doit utiliser le fil de cuivre et le noyau de fil est supérieur ou égal à $0,2\text{ mm}^2$, inférieur ou égal à 1mm^2 , afin d'assurer la connexion fiable du signal.

Lorsque les terminaux de presse à froid sont terminés, ils doivent être terminés et visualisés en stricte conformité avec les spécifications ou les exigences correspondantes et terminés selon le numéro de série de noeud correspondant.

Il est interdit d'activer les bornes à froid avant qu'elles ne soient correctement articulées ou complètement verrouillées.

Le fait de ne pas suivre les instructions peut entraîner une défaillance de la protection fournie

par l'équipement, ce qui peut entraîner des conséquences graves, comme des blessures ou des dommages à l'équipement.

DANGER

FIRE DANGER

Use the correct wiring rules only for the maximum current capacity of the I/O channel and power supply.

Failure to follow instructions specified by the manufacturer may result in serious consequences such as death, personal injury, or damage to equipment since the protection provided by the equipment may be impaired.

WARNING

UNEXPECTED EQUIPMENT OPERATION

Do not exceed any of the ratings specified in the environmental and electrical characteristics table.

Failure to follow instructions specified by the manufacturer may result in serious consequences such as death, personal injury, or damage to equipment since the protection provided by the equipment may be impaired.

AVERTISSEMENT

FONCTIONNEMENT INATTENDU DE L'EQUIPEMENT

Ne dépassez aucune évaluation spécifiée dans le tableau de caractéristiques environnementales et électriques..

Le fait de ne pas suivre les instructions peut entraîner une défaillance de la protection fournie par l'équipement, ce qui peut entraîner des conséquences graves, comme des blessures ou des dommages à l'équipement.

4 Wiring

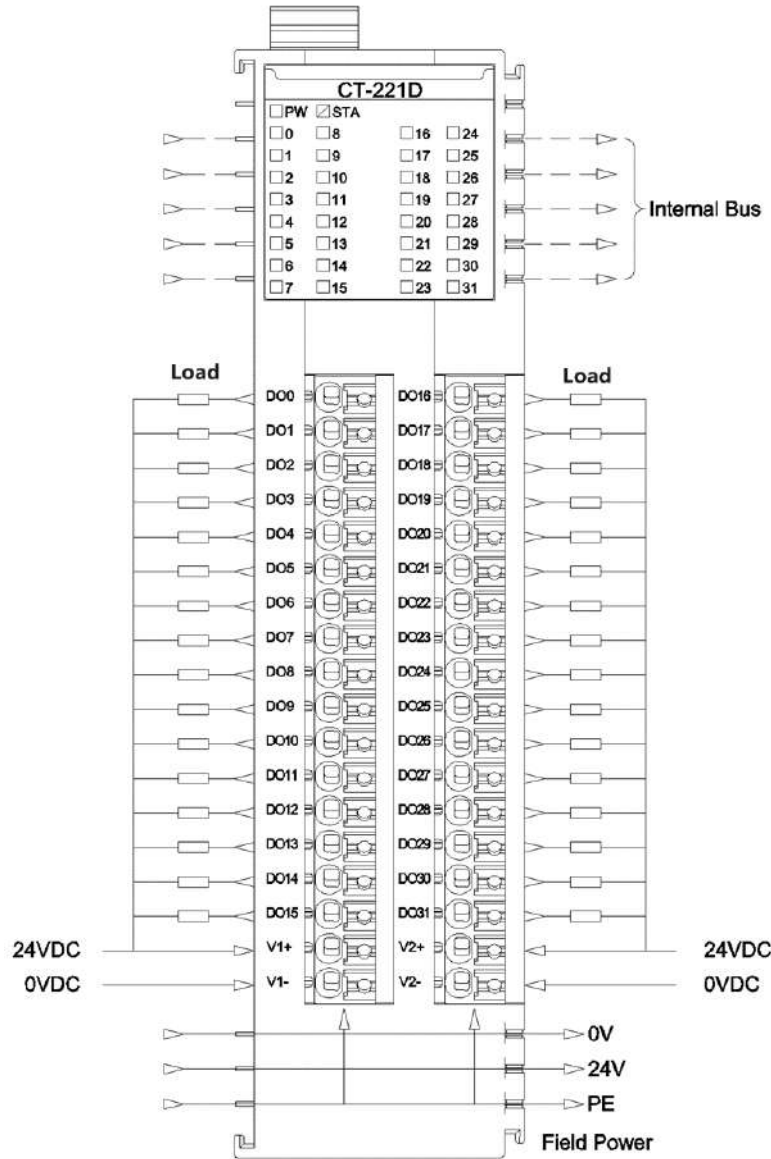

NOTICE

EQUIPMENT INOPERABLE

Do not crimp the spring terminal with more than the maximum pressure specified for the terminal. Otherwise, the resilience of the spring terminal may be damaged and the terminal rebound may be affected.

Do not press the spring terminal with a sharp tool when removing cable from the channel. Otherwise, the spring terminal will be damaged.

Failure to follow these instructions may result in equipment damage.

5 Process data definition

Output data								
Bit No	Bit 7	Bit 6	Bit 5	Bit 4	Bit 3	Bit 2	Bit 1	Bit 0
Byte 0	DO Ch#7	DO Ch#6	DO Ch#5	DO Ch#4	DO Ch#3	DO Ch#2	DO Ch#1	DO Ch#0
Byte 1	DO Ch#15	DO Ch#14	DO Ch#13	DO Ch#12	DO Ch#11	DO Ch#10	DO Ch#9	DO Ch#8

Data description:

DO Ch#(0-31): when this bit is 1, the corresponding channel output signal is valid, the output is low level, and the output is invalid when it is 0.

0: Output signal is invalid

1: Output signal is valid

6 Configuration parameter definitions

Configuration parameters								
Bit No	Bit 7	Bit 6	Bit 5	Bit 4	Bit 3	Bit 2	Bit 1	Bit 0
Byte 0	Fault Action for Output Ch#7	Fault Action for Output Ch#6	Fault Action for Output Ch#5	Fault Action for Output Ch#4	Fault Action for Output Ch#3	Fault Action for Output Ch#2	Fault Action for Output Ch#1	Fault Action for Output Ch#0
Byte 1	Fault Action for Output Ch#15	Fault Action for Output Ch#14	Fault Action for Output Ch#13	Fault Action for Output Ch#12	Fault Action for Output Ch#11	Fault Action for Output Ch#10	Fault Action for Output Ch#9	Fault Action for Output Ch#8
Byte 2	Fault Action for Output Ch#23	Fault Action for Output Ch#22	Fault Action for Output Ch#21	Fault Action for Output Ch#20	Fault Action for Output Ch#19	Fault Action for Output Ch#18	Fault Action for Output Ch#17	Fault Action for Output Ch#16
Byte 3	Fault Action for Output Ch#31	Fault Action for Output Ch#30	Fault Action for Output Ch#29	Fault Action for Output Ch#28	Fault Action for Output Ch#27	Fault Action for Output Ch#26	Fault Action for Output Ch#25	Fault Action for Output Ch#24
Byte 4	Fault Value for Output Ch#7	Fault Value for Output Ch#6	Fault Value for Output Ch#5	Fault Value for Output Ch#4	Fault Value for Output Ch#3	Fault Value for Output Ch#2	Fault Value for Output Ch#1	Fault Value for Output Ch#0

Byte 5	Fault Value for Output Ch#15	Fault Value for Output Ch#14	Fault Value for Output Ch#13	Fault Value for Output Ch#12	Fault Value for Output Ch#11	Fault Value for Output Ch#10	Fault Value for Output Ch#9	Fault Value for Output Ch#8
Byte 6	Fault Value for Output Ch#23	Fault Value for Output Ch#22	Fault Value for Output Ch#21	Fault Value for Output Ch#20	Fault Value for Output Ch#19	Fault Value for Output Ch#18	Fault Value for Output Ch#17	Fault Value for Output Ch#16
Byte 7	Fault Value for Output Ch#31	Fault Value for Output Ch#30	Fault Value for Output Ch#29	Fault Value for Output Ch#28	Fault Value for Output Ch#27	Fault Value for Output Ch#26	Fault Value for Output Ch#25	Fault Value for Output Ch#24

Data description:

Fault Action for Output Ch#(0-31): Fault Output mode. When the IO module detects an internal bus exception and fails to communicate with the adapter. And the module will turn to offline mode, so the output data is processed in this way. (default: 0)

0: keep the last time output State.

1: output fault value.

Fault Value for Output Ch#(0-31): when the Fault Output mode is 1, this bit sets the Fault Output Value, and this setting value will be outputted when the internal bus of IO module is offline. (default: 0)

0: Output low level.

1: Output high level.

A Dimension drawing

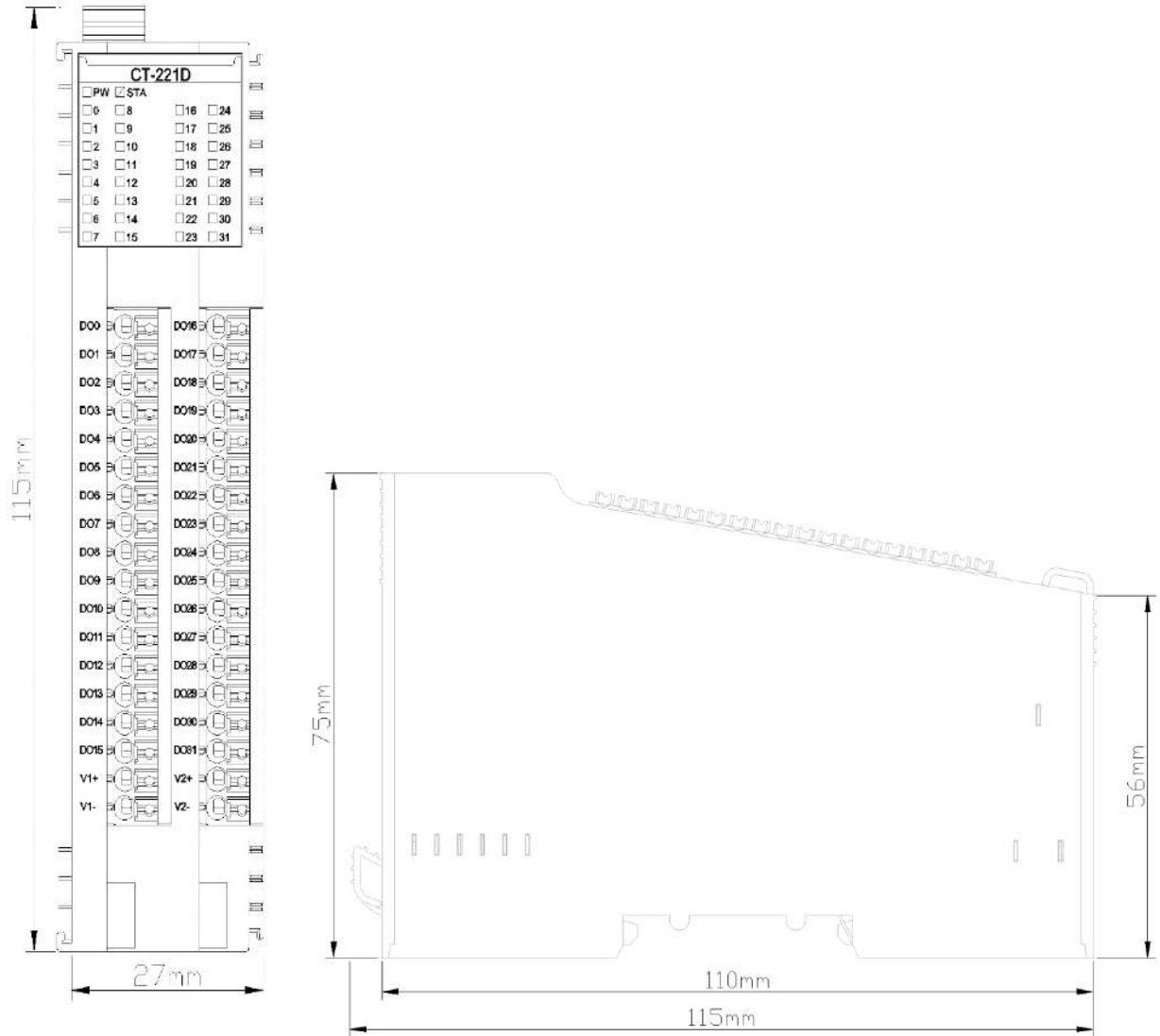

CT-2244 4 channels digital output/24VDC/ PNP or NPN

1 Module features

- ◆ The module supports 4-channel digital output, the output voltage is 24VDC and the output high level is valid; or the output voltage is 0V and the output low level is valid.
- ◆ The module could be configured with the output mode through the software: high level output, low level output or push-pull output
- ◆ The module could drive field equipment (relay, solenoid valve, etc.)
- ◆ The internal bus of the module is isolated from the field output
- ◆ The module carries with 4 digital output channel LED indicator
- ◆ The module supports short circuit protection and overcurrent protection

2 Technical Parameters

General Parameters	
Power Consumption	Max.50mA@5.0VDC
Isolation	I/O to internal bus: opto-couple isolation (3KVrms)
Field Power	The isolation voltage between the I/O channel and the system power supply: AC500V The isolation voltage between the I/O channel and the field power supply: AC500V Isolation voltage between the I/O channel and PE: AC 500V
Field Power	Nominal:24VDC, Range:20.4-28.8VDC
Wiring	Max.: AWG 18 Min.: AWG 24
Installation	35mm DIN-Rail
Size	115*14*75mm
Weight	65g
Environment Specification	
Operating Temperature of Horizontal Installation	-35°C~70°C
Operating Temperature of Vertical Installation	-35°C~60°C
Relative Humidity	< 95%RH (No Condensation)
Storage Temperature	-40°C~85°C
Storage Humidity	< 95%RH (No Condensation)
Manufacturing Test Temperature	-40°C~75°C
Ingress Protection Rating	IP20
Output Parameters	
Channel Number	4 Channels
LED Indicator	4 Channels output LED Indicator, 1 power indicator and 1 two-color indicator
Output Type	High-side/ Low-side/Push-pull output (Software configurable)
Output Current	Max.0.5A@DC24V
Output Impedance	High-side drive Max: 0.65Ω Low-side drive Max: 0.50Ω
Leak Current	High-side drive Max: 210uA Low-side drive Max: 310uA
Turn-on Delay	Max:80us
Output Protection	Over temperature turn-off: typical value 125°C Short circuit/overcurrent protection: typical value 1A
Load type	General use and Resistive, Pilot Duty
EMC parameters	
Static Electricity	Air 8KV/ Contact 4KV`

EFT	2KV
Surge	2KV

⚠ WARNING

UNEXPECTED EQUIPMENT OPERATION

Do not exceed any of the ratings specified in the environmental and electrical characteristics table.

Failure to follow instructions specified by the manufacturer may result in serious consequences such as death, personal injury, or damage to equipment since the protection provided by the equipment may be impaired.

⚠ AVERTISSEMENT

FONCTIONNEMENT INATTENDU DE L'EQUIPEMENT

Ne dépassez aucune évaluation spécifiée dans le tableau de caractéristiques environnementales et électriques..

Le fait de ne pas suivre les instructions peut entraîner une défaillance de la protection fournie par l'équipement, ce qui peut entraîner des conséquences graves, comme des blessures ou des dommages à l'équipement.

3 Hardware Interface

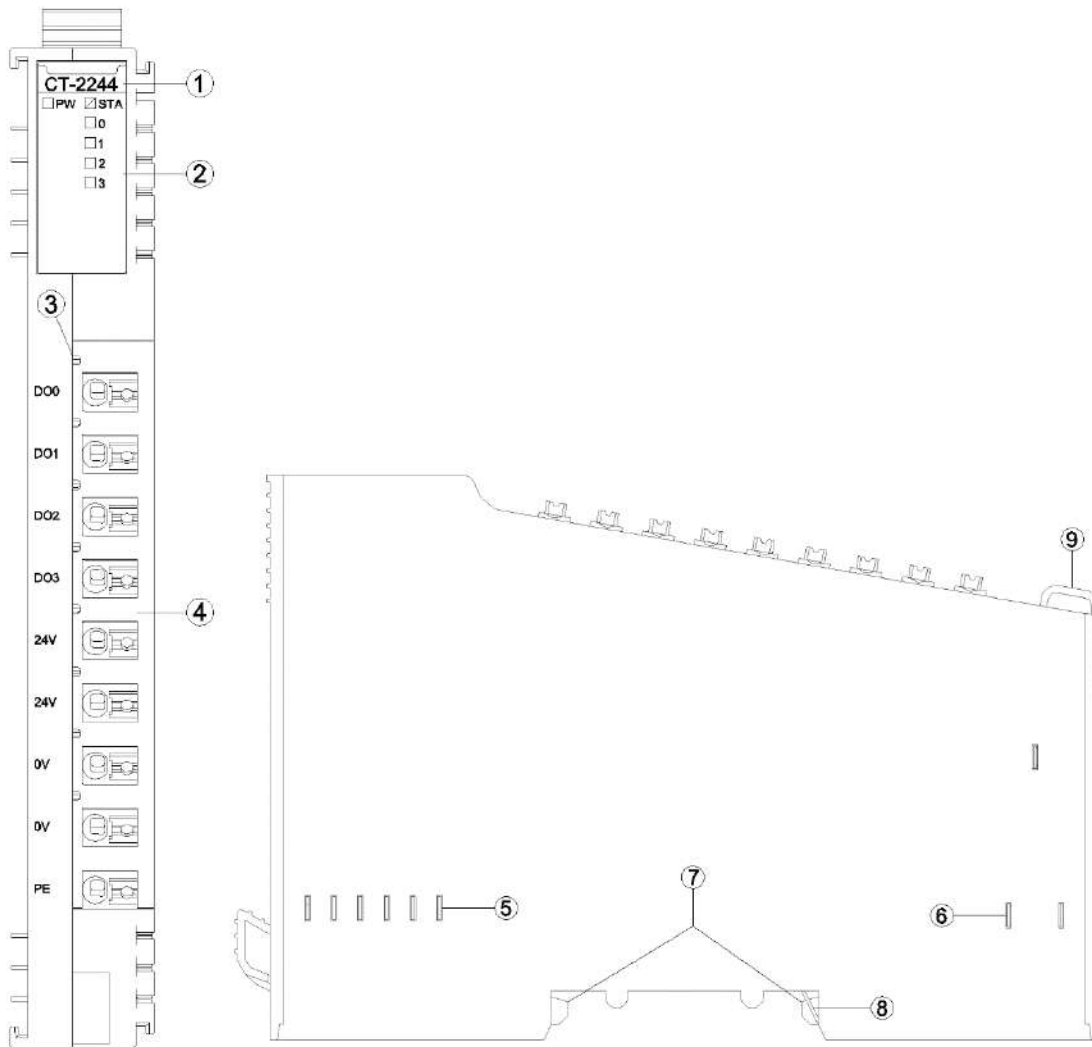

- ① Module Type
- ② State indicator
- ③ Channel indicator
- ④ Wiring Terminal and identification
- ⑤ Internal Bus
- ⑥ Field Power
- ⑦ Buckle
- ⑧ Grounding Spring Sheet
- ⑨ Fixed Wiring Harness

3.1 LED indicator definition

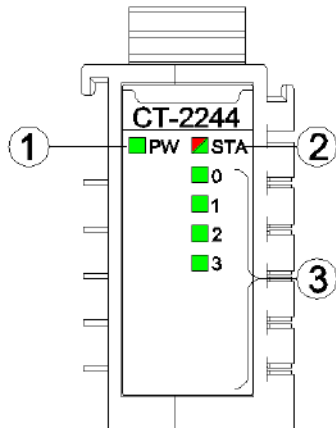

- ① Power LED indicator (green)
- ② Module State LED indicator (red/green)
- ③ Output channel LED indicator (green)

PW Power State (GREEN)	Definition
ON	Internal bus Power Normal
OFF	Internal bus Power Failure
STA Module State (RED/GREEN)	Definition
Green slow flash (2.5Hz)	Module internal bus is not started
Red slow flash (2.5Hz)	Module internal bus offline
ON (GREEN)	Operation normal
Flash(2.5Hz) (RED/GREEN)	Upgrading mode
Flash(10Hz) (RED/GREEN)	Firmware Update
Double Flash (RED)	Module Exception has been soft-restarted
0-3 channel LED indicator (GREEN)	Definition
ON	Output signal valid
OFF	Output signal invalid

⚠ WARNING

UNEXPECTED EQUIPMENT OPERATION

By viewing the PW indicator, could determine the power supply status of a module. If the PW is steady green, the power supply is normal. Otherwise, the module cannot work properly.

When the module is initially powered on, there will be 3S for the backplane bus connection. After the backplane bus is initialized, STA is in the green steady state. If STA is in the green blinking state, it indicates that the backplane bus has not been initialized, and it needs to be powered off and restarted for re-initialization.

STA abnormal working state occurs during the normal operation of the module, please check the firmware version information of all modules, and consult ODOT technical support for details.

If a module is upgraded, check that all modules are in the normal state after the upgrade. Otherwise, an exception may occur.

Failure to follow instructions specified by the manufacturer may result in serious consequences such as death, personal injury, or damage to equipment since the protection provided by the equipment may be impaired.

! AVERTISSEMENT

FONCTIONNEMENT INATTENDU DE L'EQUIPEMENT

En regardant l'état de l'indicateur de PW, jugez l'état d'alimentation du module. Le feu vert PW reste allumé et l'alimentation est normale. Autrement, le module ne fonctionnera pas correctement.

Lorsque le module est alimenté initialement, il y aura 3S pour la connexion de bus de backboard. STA est un état vert permanent après l'initialisation du bus de backboard. Si STA est en état de clignotement vert, cela signifie que l'initialisation du bus de backboard n'est pas passée et doit être redémarrée hors tension et réinitialisée.

L'état de fonctionnement anormal de STA se produit pendant le fonctionnement normal du module, veuillez vérifier les informations de version du firmware de tous les modules, et consulter le support technique ODOT pour plus de détails.

Si le module a une opération de mise à niveau, après l'achèvement de la mise à niveau, le besoin de vérifier que tous les modules sont dans l'état normal avant de courir, sinon il conduira à une exception.

Le fait de ne pas suivre les instructions peut entraîner une défaillance de la protection fournie par l'équipement, ce qui peut entraîner des conséquences graves, comme des blessures ou des dommages à l'équipement.

3.2 Field channel LED indicator (Green)

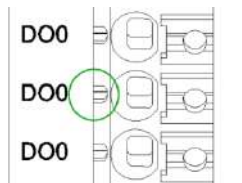

When the output signal of the output channel is valid, the corresponding field channel LED indicator is on.

3.3 Terminal definition

Terminal Number	Symbol	Description
1	DO0	Signal output
2	DO1	
3	DO2	
4	DO3	
5	24V	Power input
6	24V	
7	0V	
8	0V	
9	PE	Ground

WARNING

UNEXPECTED EQUIPMENT OPERATION

Calculate the maximum field power current consumption of a single module based on the actual field load. If the total field power current consumption of all I/O modules exceeds the power supply capacity of the field power supply, you must add an extra power expansion module. Otherwise, an output channel exception may occur.

Failure to follow instructions specified by the manufacturer may result in serious consequences such as death, personal injury, or damage to equipment since the protection provided by the equipment may be impaired.

AVERTISSEMENT

FONCTIONNEMENT INATTENDU DE L'EQUIPEMENT

Calculez la consommation maximale de courant de champ d'un seul module en fonction de la charge de champ réelle. Si la consommation totale de courant de champ de tous les modules d'E/S dépasse la capacité d'alimentation de l'alimentation de champ, vous devez ajouter un module d'extension de puissance supplémentaire. Dans le cas contraire, une exception de canal de sortie peut se produire.

Le fait de ne pas suivre les instructions peut entraîner une défaillance de la protection fournie par l'équipement, ce qui peut entraîner des conséquences graves, comme des blessures ou des dommages à l'équipement.

When connecting a cold-pressed terminal, the terminal must be terminated and checked in strict accordance with the corresponding termination specifications or requirements, and connect the cold-pressed terminal according to the corresponding node serial number. The conductor should use copper conductor and the conductor core should be larger than 0.2mm² and smaller than 1mm² (AWG18~AWG24). Cold-pressed terminal parameters are as follows:

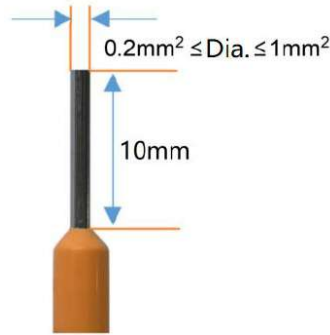

⚠ WARNING

UNEXPECTED EQUIPMENT OPERATION

Strip the length of the conductor insulation layer is greater than 10mm to ensure reliable signal connection.

The wire needs to use copper wire and the wire core is greater than or equal to 0.2mm² and less than or equal to 1mm² to ensure reliable signal connection.

When connecting a cold-press terminal, connect the cold-press terminal strictly in accordance with the corresponding termination specifications or requirements, and connect the cold-press terminal according to the corresponding node serial number.

Do not power on cold-press terminals until they are properly connected or fully locked.

Failure to follow instructions specified by the manufacturer may result in serious consequences such as death, personal injury, or damage to equipment since the protection provided by the equipment may be impaired.

⚠ AVERTISSEMENT

FONCTIONNEMENT INATTENDU DE L'ÉQUIPEMENT

Dépouillez la longueur de la couche isolante du fil plus de 10mm pour assurer la connexion fiable du signal.

Le conducteur doit utiliser le fil de cuivre et le noyau de fil est supérieur ou égal à 0,2 mm², inférieur ou égal à 1mm², afin d'assurer la connexion fiable du signal.

Lorsque les terminaux de presse à froid sont terminés, ils doivent être terminés et visualisés en stricte conformité avec les spécifications ou les exigences correspondantes et terminés selon le numéro de série de noeud correspondant.

Il est interdit d'activer les bornes à froid avant qu'elles ne soient correctement articulées ou complètement verrouillées.

Le fait de ne pas suivre les instructions peut entraîner une défaillance de la protection fournie par l'équipement, ce qui peut entraîner des conséquences graves, comme des blessures ou des dommages à l'équipement.

⚠ DANGER

FIRE DANGER

Use the correct wiring rules only for the maximum current capacity of the I/O channel and power supply.

Failure to follow instructions specified by the manufacturer may result in serious consequences such as death, personal injury, or damage to equipment since the protection provided by the equipment may be impaired.

 WARNING

UNEXPECTED EQUIPMENT OPERATION

Do not exceed any of the ratings specified in the environmental and electrical characteristics table.

Failure to follow instructions specified by the manufacturer may result in serious consequences such as death, personal injury, or damage to equipment since the protection provided by the equipment may be impaired.

 AVERTISSEMENT

FONCTIONNEMENT INATTENDU DE L'EQUIPEMENT

Ne dépassez aucune évaluation spécifiée dans le tableau de caractéristiques environnementales et électriques..

Le fait de ne pas suivre les instructions peut entraîner une défaillance de la protection fournie par l'équipement, ce qui peut entraîner des conséquences graves, comme des blessures ou des dommages à l'équipement.

4 Wiring

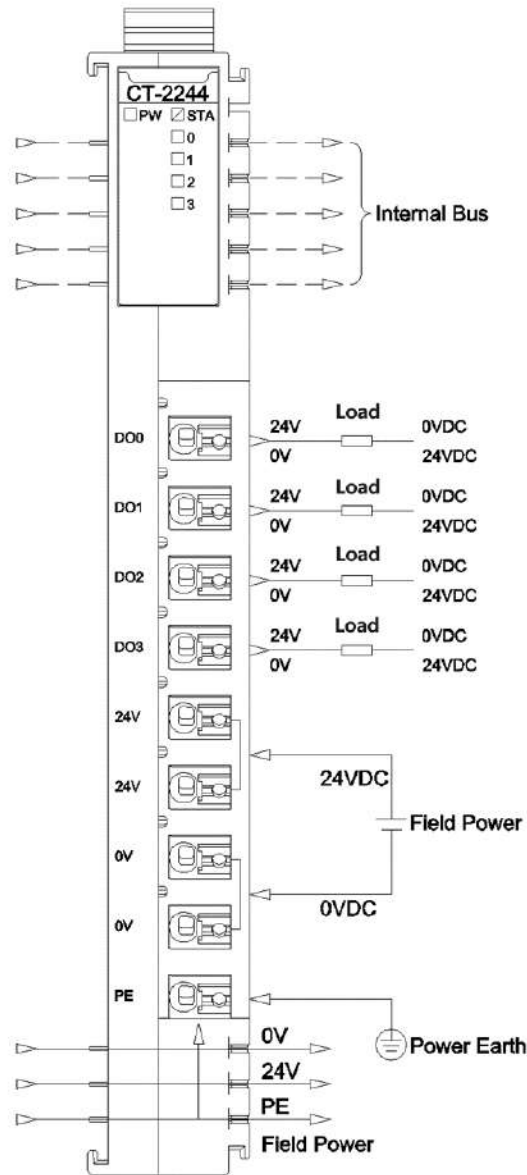

NOTICE

EQUIPMENT INOPERABLE

Do not crimp the spring terminal with more than the maximum pressure specified for the terminal. Otherwise, the resilience of the spring terminal may be damaged and the terminal rebound may be affected.

Do not press the spring terminal with a sharp tool when removing cable from the channel. Otherwise, the spring terminal will be damaged.

Failure to follow these instructions may result in equipment damage.

5 Process data definition

5.1 CT-2244 process data definition

Output Data								
Bit No	Bit 7	Bit 6	Bit 5	Bit 4	Bit 3	Bit 2	Bit 1	Bit 0
Byte 0	Reserve				DO Ch#3	DO Ch#2	DO Ch#1	DO Ch#0

Data description:

DO Ch#(0-3): When the bit is 1, the output signal of the corresponding channel is effective, the output is low level, and the output is invalid when it is 0.

0: The output signal is invalid

1: The output signal is valid

5.2 PWM submodule process data definition

The PWM submodule can only be placed in slot 1 to set the PWM output of the module.

Output Data								
Bit No	Bit 7	Bit 6	Bit 5	Bit 4	Bit 3	Bit 2	Bit 1	Bit 0
Byte 0	PWM Duty Cycle CH#0							
Byte 1	PWM Duty Cycle CH#1							
Byte 2	PWM Duty Cycle CH#2							
Byte 3	PWM Duty Cycle CH#3							

Data description:

PWM Duty Cycle CH#(0~3): Output duty cycle settings, range: 0-100(0x00~0Xff)

5.3 Diagnostic submodule process data definition

Output Data								
Bit No	Bit 7	Bit 6	Bit 5	Bit 4	Bit 3	Bit 2	Bit 1	Bit 0
Byte 0	OPEN OVERLOAD CH#3	OPEN OVERLOAD CH#2	OPEN OVERLOAD CH#1	OPEN OVERLOAD CH#0	OVER CURRENT CH#3	OVER CURRENT CH#2	OVER CURRENT CH#1	OVER CURRENT CH#0
Byte 1	Reserved			OVER TEMPERATURE	SHORT CIRCUIT CH#3	SHORT CIRCUIT CH#2	SHORT CIRCUIT CH#1	SHORT CIRCUIT CH#0

Data description:

OVER CURRENT CH# (0~3): Channel overcurrent flag bit

0: Channel normal

1: Channel overcurrent

OPEN OVERLOAD CH# (0~3): Channel load open-circuit flag bit

0: Channel normal

1: Channel load open-circuit

SHORT CIRCUIT CH#(0~3): Channel short circuit flag bit

0: Channel normal

1: Channel short circuit

OVER TEMPERATURE: Channel over temperature flag bit

0: Channel normal

1: Channel over temperature

6 Configuration parameters

6.1 CT-2244 configuration parameters definition

Configuration parameters								
Bit No	Bit 7	Bit 6	Bit 5	Bit 4	Bit 3	Bit 2	Bit 1	Bit 0
Byte 0	Mode Action CH#3		Mode Action CH#2		Mode Action CH#1		Mode Action CH#0	
Byte 1	Reserved				Fault Action Ch#3	Fault Action Ch#2	Fault Action Ch#1	Fault Action Ch#0
Byte 2	Reserved				Fault Value Ch#3	Fault Value Ch#2	Fault Value Ch#1	Fault Value Ch#0

Data description:

Mode Action: Output mode configuration. (default:0)

- 0: Push-pull output
- 1: Source output
- 2: Sink output

Fault Action: Fault Output mode. When the IO module detects an internal bus exception and fails to communicate with the adapter. And the module will turn to offline mode, so the output data is processed in this way. (default: 0)

- 0: keep the last time output State.
- 1: output fault value.

Fault Value: When the Fault Output mode is 1, this bit sets the Fault Output Value, and this setting value will be outputted when the internal bus of IO module is offline. (default: 0)

- 0: Output low level.
- 1: Output high level.

6.2 PWM submodule process data definition

Output data								
Bit No	Bit 7	Bit 6	Bit 5	Bit 4	Bit 3	Bit 2	Bit 1	Bit 0
Byte 0	PWM Hz CH#1				PWM Hz CH#0			
Byte 1	PWM Hz CH#3				PWM Hz CH#2			

Byte 2	Reserved	Module Offline Fault Output
--------	----------	--------------------------------------

Data description:

PWM Hz Ch#(0~3): PWM output frequency setting (default:0)

- 0 1K Hz;
- 1: 875 Hz;
- 2: 750 Hz;
- 3: 625 Hz;
- 4: 500 Hz;
- 5: 375 Hz;
- 6: 250 Hz;
- 7: 125 Hz

Module Offline Fault Action Output: Module offline fault action output. (Default:1)

- 0: Keep the last output value
- 1: Reset

A Dimension drawing

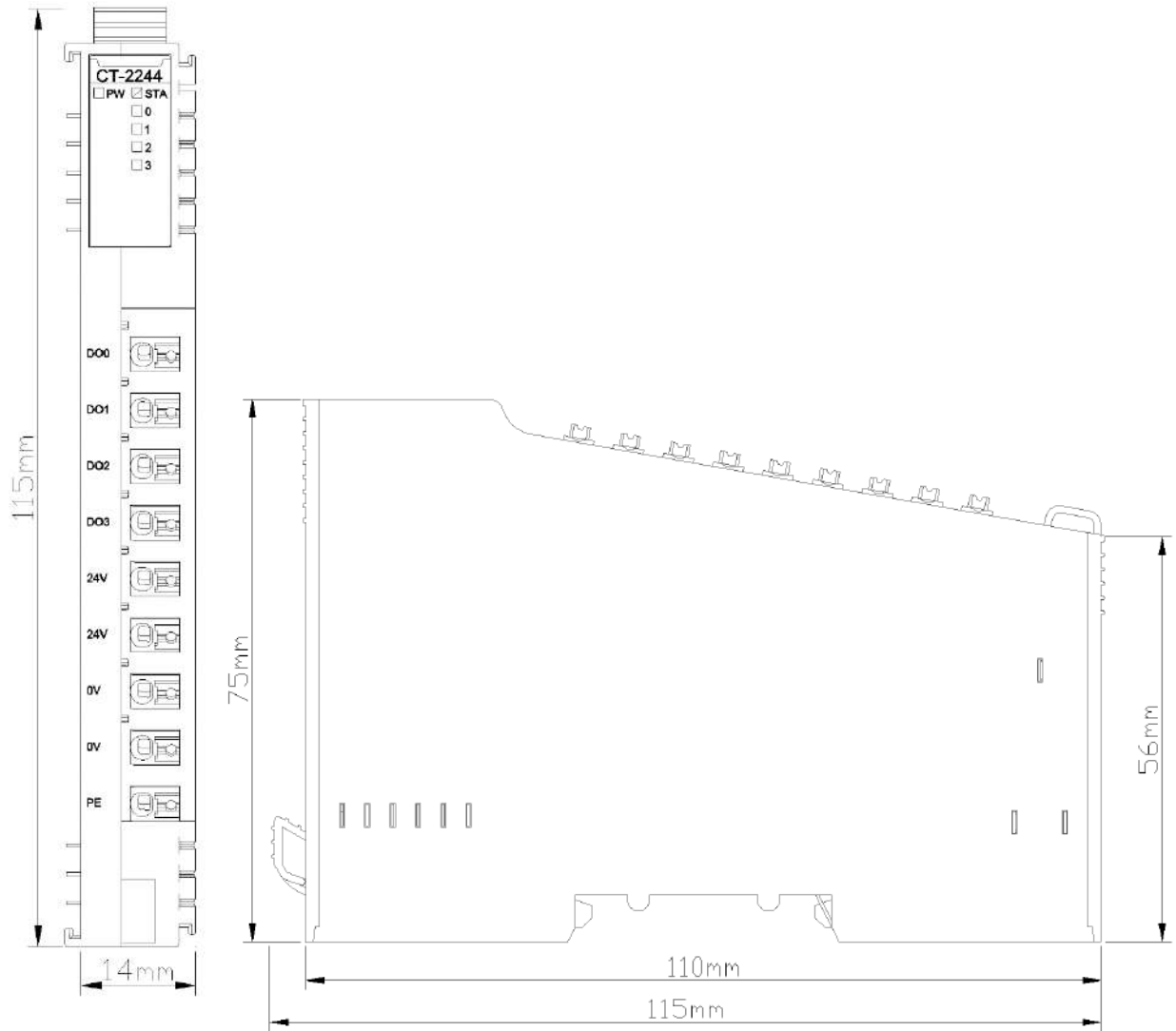

CT-225F 16 channels digital output/24VDC/NPN

1 Module features

- ◆ The module supports 16 channels digital output, the output voltage is 0V and the output low level is valid.
- ◆ The module can drive field equipment (relay, solenoid valve, etc.)
- ◆ The internal bus and field output of the module both adopt electromagnetic isolation
- ◆ The module carries 16 digital output channel LED indicator
- ◆ The module has the function of thermal shutdown and over current protection
- ◆ The module supports short circuit protection and overload protection
- ◆ The module output channel loop power supply requires 24VDC external power supply.

2 Technical parameters

General Parameters	
Power	Max.60mA@5.0VDC
Isolation	The isolation voltage between the I/O channel and the system power supply: AC500V The isolation voltage between the I/O channel and the field power supply: AC500V Isolation voltage between the I/O channel and PE: AC 500V
Field Power	Nominal:24VDC, Range:20.4-28.8VDC
Wiring	Max.: AWG 18 Min.: AWG 24
Installation	35mm DIN-Rail
Size	115*14*75mm
Weight	80g
Environment Specification	
Operating Temperature of Horizontal Installation	-35°C~70°C
Operating Temperature of Vertical Installation	-35°C~60°C
Relative Humidity	< 95%RH (No Condensation)
Storage Temperature	-40°C~85°C
Storage Humidity	< 95%RH (No Condensation)
Manufacturing Test Temperature	-40°C~75°C
Ingress Protection Rating	IP20
Output Parameters	
Channel Number	16 channel sink type output
LED Indicator	16 channel output LED indicator
Rated Current	single channel output: Max.1500mA simultaneously output: Max.250mA
Leakage Current	Max. 5uA
On Resistance	Typical value: 260mΩ
Output Delay	OFF to ON: Max.100us ON to OFF: Max.150us
Protection Function	Over-temperature shut down: typical value 150°C Overcurrent protection: typical value 1.8A Short circuit protection: supported Channel independent protection
Output Type	Sink / Low-side output
Load type	General use and Resistive, Pilot Duty
EMC parameters	
Static Electricity	Air 8KV/ Contact 6KV
EFT	1KV

 **WARNING**

UNEXPECTED EQUIPMENT OPERATION

Do not exceed any of the ratings specified in the environmental and electrical characteristics table.

Failure to follow instructions specified by the manufacturer may result in serious consequences such as death, personal injury, or damage to equipment since the protection provided by the equipment may be impaired.

 **AVERTISSEMENT**

FONCTIONNEMENT INATTENDU DE L'EQUIPEMENT

Ne dépassez aucune évaluation spécifiée dans le tableau de caractéristiques environnementales et électriques..

Le fait de ne pas suivre les instructions peut entraîner une défaillance de la protection fournie par l'équipement, ce qui peut entraîner des conséquences graves, comme des blessures ou des dommages à l'équipement.

3 Hardware interfaces

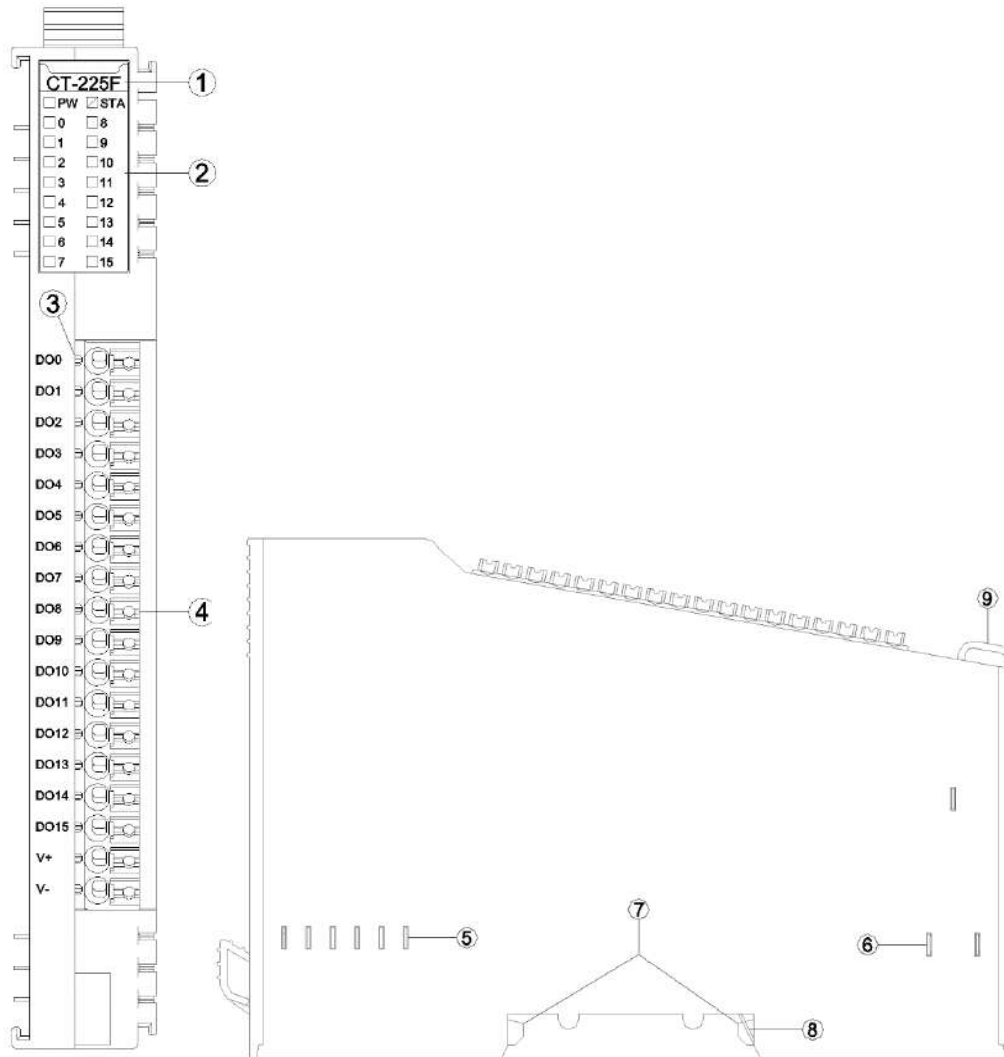

- ① Module Type
- ② State indicator
- ③ Channel indicator
- ④ Wiring Terminal and identification
- ⑤ Internal Bus
- ⑥ Field Power
- ⑦ Buckle
- ⑧ Grounding Spring Sheet
- ⑨ Fixed Wiring Harness

3.1 LED indicator definition

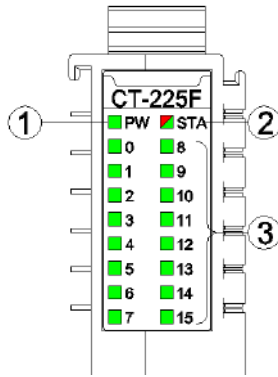

- ① Power LED indicator (green)
- ② Module State LED indicator (red/green)
- ③ Output channel LED indicator (green)

PW Power State (GREEN)	Definition
ON	Internal bus Power Normal
OFF	Internal bus Power Failure
STA Module State (RED/GREEN)	Definition
Green slow flash (2.5Hz)	Module internal bus is not started
Red slow flash (2.5Hz)	Module internal bus offline
ON (GREEN)	Operation normal
Flash(2.5Hz) (RED/GREEN)	Upgrading mode
Flash(10Hz) (RED/GREEN)	Firmware Update
Double Flash (RED)	Module Exception has been soft-restarted
0-15 channel indicator light	Definition
ON	Output signal valid
OFF	Output signal invalid

! WARNING

UNEXPECTED EQUIPMENT OPERATION

By viewing the PW indicator, could determine the power supply status of a module. If the PW is steady green, the power supply is normal. Otherwise, the module cannot work properly.

When the module is initially powered on, there will be 3S for the backplane bus connection. After the backplane bus is initialized, STA is in the green steady state. If

STA is in the green blinking state, it indicates that the backplane bus has not been initialized, and it needs to be powered off and restarted for re-initialization.

STA abnormal working state occurs during the normal operation of the module, please check the firmware version information of all modules, and consult ODOT technical support for details.

If a module is upgraded, check that all modules are in the normal state after the upgrade. Otherwise, an exception may occur.

Failure to follow instructions specified by the manufacturer may result in serious consequences such as death, personal injury, or damage to equipment since the protection provided by the equipment may be impaired.

AVERTISSEMENT

FONCTIONNEMENT INATTENDU DE L'EQUIPEMENT

En regardant l'état de l'indicateur de PW, jugez l'état d'alimentation du module. Le feu vert PW reste allumé et l'alimentation est normale. Autrement, le module ne fonctionnera pas correctement.

Lorsque le module est alimenté initialement, il y aura 3S pour la connexion de bus de backboard. STA est un état vert permanent après l'initialisation du bus de backboard. Si STA est en état de clignotement vert, cela signifie que l'initialisation du bus de backboard n'est pas passée et doit être redémarrée hors tension et réinitialisée.

L'état de fonctionnement anormal de STA se produit pendant le fonctionnement normal du module, veuillez vérifier les informations de version du firmware de tous les modules, et consulter le support technique ODOT pour plus de détails.

Si le module a une opération de mise à niveau, après l'achèvement de la mise à niveau, le besoin de vérifier que tous les modules sont dans l'état normal avant de courir, sinon il conduira à une exception.

Le fait de ne pas suivre les instructions peut entraîner une défaillance de la protection fournie par l'équipement, ce qui peut entraîner des conséquences graves, comme des blessures ou des dommages à l'équipement.

3.2 Field channel LED indicator (Green)

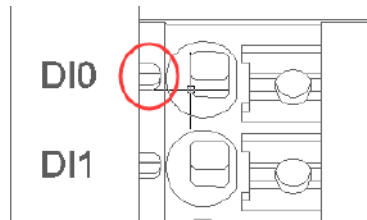

When output signal of output channel is valid, the corresponding field channel LED indicator is on.

3.3 Terminal definition

Terminal Number	Symbol	Description
1	DI0	Signal output
2	DI1	
3	DI2	
4	DI3	
5	DI4	
6	DI5	
7	DI6	
8	DI7	
9	DI8	Signal output
10	DI9	
11	DI10	
12	DI11	
13	DI12	
14	DI13	
15	DI14	
16	DI15	
17	V+	Power input (<i>Note</i>)
18	V-	Power input

Note:

When V+ and V- terminals are connected to the power supply at the same time, the sum of the current of all output channels is a maximum of 4A.

WARNING

UNEXPECTED EQUIPMENT OPERATION

Calculate the maximum field power current consumption of a single module based on the actual field load. If the total field power current consumption of all I/O modules exceeds the power supply capacity of the field power supply, you must add an extra power expansion module. Otherwise, an output channel exception may occur.

Failure to follow instructions specified by the manufacturer may result in serious consequences such as death, personal injury, or damage to equipment since the protection provided by the equipment may be impaired.

⚠️ AVERTISSEMENT

FONCTIONNEMENT INATTENDU DE L'ÉQUIPEMENT

Calculez la consommation maximale de courant de champ d'un seul module en fonction de la charge de champ réelle. Si la consommation totale de courant de champ de tous les modules d'E/S dépasse la capacité d'alimentation de l'alimentation de champ, vous devez ajouter un module d'extension de puissance supplémentaire. Dans le cas contraire, une exception de canal de sortie peut se produire.

Le fait de ne pas suivre les instructions peut entraîner une défaillance de la protection fournie par l'équipement, ce qui peut entraîner des conséquences graves, comme des blessures ou des dommages à l'équipement.

When connecting a cold-pressed terminal, the terminal must be terminated and checked in strict accordance with the corresponding termination specifications or requirements, and connect the cold-pressed terminal according to the corresponding node serial number. The conductor should use copper conductor and the conductor core should be larger than 0.2mm^2 and smaller than 1mm^2 (AWG18~AWG24). Cold-pressed terminal parameters are as follows:

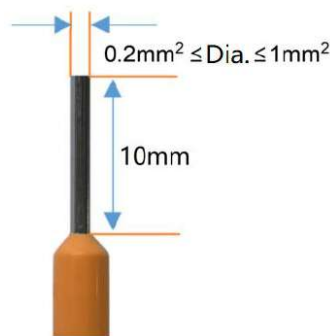

⚠️ WARNING

UNEXPECTED EQUIPMENT OPERATION

Strip the length of the conductor insulation layer is greater than 10mm to ensure reliable signal connection.

The wire needs to use copper wire and the wire core is greater than or equal to 0.2mm^2 and less than or equal to 1mm^2 to ensure reliable signal connection.

When connecting a cold-press terminal, connect the cold-press terminal strictly in

accordance with the corresponding termination specifications or requirements, and connect the cold-press terminal according to the corresponding node serial number.

Do not power on cold-press terminals until they are properly connected or fully locked.

Failure to follow instructions specified by the manufacturer may result in serious consequences such as death, personal injury, or damage to equipment since the protection provided by the equipment may be impaired.

AVERTISSEMENT

FONCTIONNEMENT INATTENDU DE L'EQUIPEMENT

Dépouillez la longueur de la couche isolante du fil plus de 10mm pour assurer la connexion fiable du signal.

Le conducteur doit utiliser le fil de cuivre et le noyau de fil est supérieur ou égal à 0,2 mm², inférieur ou égal à 1mm², afin d'assurer la connexion fiable du signal.

Lorsque les terminaux de presse à froid sont terminés, ils doivent être terminés et visualisés en stricte conformité avec les spécifications ou les exigences correspondantes et terminés selon le numéro de série de noeud correspondant.

Il est interdit d'activer les bornes à froid avant qu'elles ne soient correctement articulées ou complètement verrouillées.

Le fait de ne pas suivre les instructions peut entraîner une défaillance de la protection fournie par l'équipement, ce qui peut entraîner des conséquences graves, comme des blessures ou des dommages à l'équipement.

DANGER

FIRE DANGER

Use the correct wiring rules only for the maximum current capacity of the I/O channel and power supply.

Failure to follow instructions specified by the manufacturer may result in serious consequences such as death, personal injury, or damage to equipment

since the protection provided by the equipment may be impaired.

 **WARNING**

UNEXPECTED EQUIPMENT OPERATION

Do not exceed any of the ratings specified in the environmental and electrical characteristics table.

Failure to follow instructions specified by the manufacturer may result in serious consequences such as death, personal injury, or damage to equipment since the protection provided by the equipment may be impaired.

 **AVERTISSEMENT**

FONCTIONNEMENT INATTENDU DE L'EQUIPEMENT

Ne dépassez aucune évaluation spécifiée dans le tableau de caractéristiques environnementales et électriques..

Le fait de ne pas suivre les instructions peut entraîner une défaillance de la protection fournie par l'équipement, ce qui peut entraîner des conséquences graves, comme des blessures ou des dommages à l'équipement.

4 Wiring

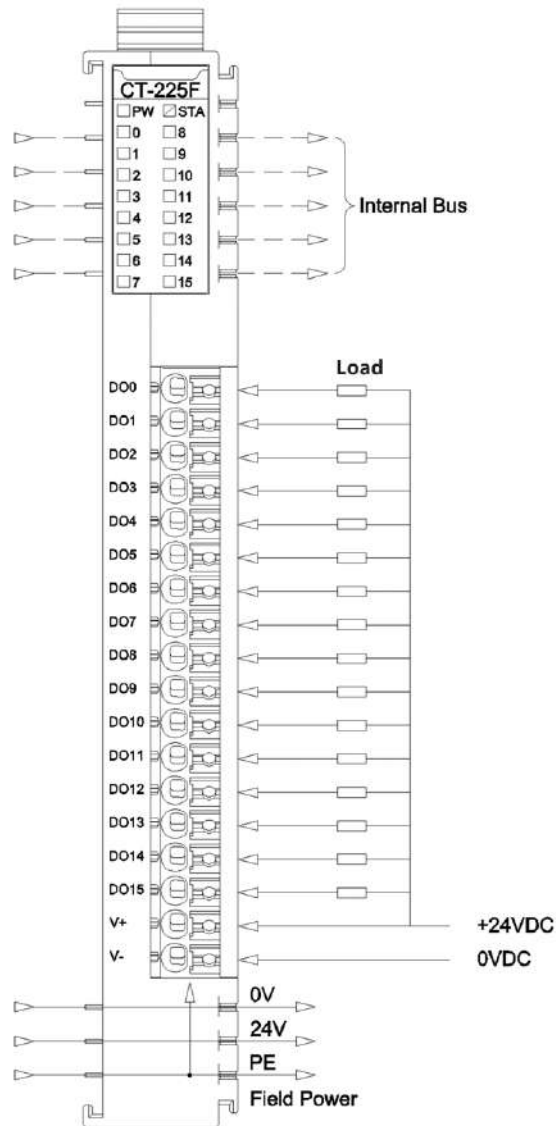

NOTICE

EQUIPMENT INOPERABLE

Do not crimp the spring terminal with more than the maximum pressure specified for the terminal. Otherwise, the resilience of the spring terminal may be damaged and the terminal rebound may be affected.

Do not press the spring terminal with a sharp tool when removing cable from the channel. Otherwise, the spring terminal will be damaged.

Failure to follow these instructions may result in equipment damage.

5 Process data definition

Output data								
Bit No	Bit 7	Bit 6	Bit 5	Bit 4	Bit 3	Bit 2	Bit 1	Bit 0
Byte 0	DO Ch#7	DO Ch#6	DO Ch#5	DO Ch#4	DO Ch#3	DO Ch#2	DO Ch#1	DO Ch#0
Byte 1	DO Ch#15	DO Ch#14	DO Ch#13	DO Ch#12	DO Ch#11	DO Ch#10	DO Ch#9	DO Ch#8

Data description:

DI Ch#(0-15): When the corresponding channel output signal is valid, the bit is 1, and when the input is invalid, it is 0.

0: Output signal invalid

1: Output signal valid

6 Configuration parameter definitions

Configuration parameters								
Bit No	Bit 7	Bit 6	Bit 5	Bit 4	Bit 3	Bit 2	Bit 1	Bit 0
Byte 0	Fault Action for Output Ch#7	Fault Action for Output Ch#6	Fault Action for Output Ch#5	Fault Action for Output Ch#4	Fault Action for Output Ch#3	Fault Action for Output Ch#2	Fault Action for Output Ch#1	Fault Action for Output Ch#0
Byte 1	Fault Action for Output Ch#15	Fault Action for Output Ch#14	Fault Action for Output Ch#13	Fault Action for Output Ch#12	Fault Action for Output Ch#11	Fault Action for Output Ch#10	Fault Action for Output Ch#9	Fault Action for Output Ch#8
Byte 2	Fault Value for Output Ch#7	Fault Value for Output Ch#6	Fault Value for Output Ch#5	Fault Value for Output Ch#4	Fault Value for Output Ch#3	Fault Value for Output Ch#2	Fault Value for Output Ch#1	Fault Value for Output Ch#0
Byte 3	Fault Value for Output Ch#15	Fault Value for Output Ch#14	Fault Value for Output Ch#13	Fault Value for Output Ch#12	Fault Value for Output Ch#11	Fault Value for Output Ch#10	Fault Value for Output Ch#9	Fault Value for Output Ch#8
Byte 4	Reserved							
Byte 5								

Data description:

Fault Action for Output Ch#(0-15): Fault Output mode. When the IO module detects an internal bus exception and fails to communicate with the adapter. And the module will turn to offline mode, so the output data is processed in this way. (default: 0)

0: keep the last time output State.

1: output fault value.

Fault Value for Output Ch#(0-15): when the Fault Output mode is 1, this bit sets the Fault Output Value, and this setting value will be outputted when the internal bus of IO module is offline. (default: 0)

0: Output low level.

1: Output high level.

A Dimension drawing

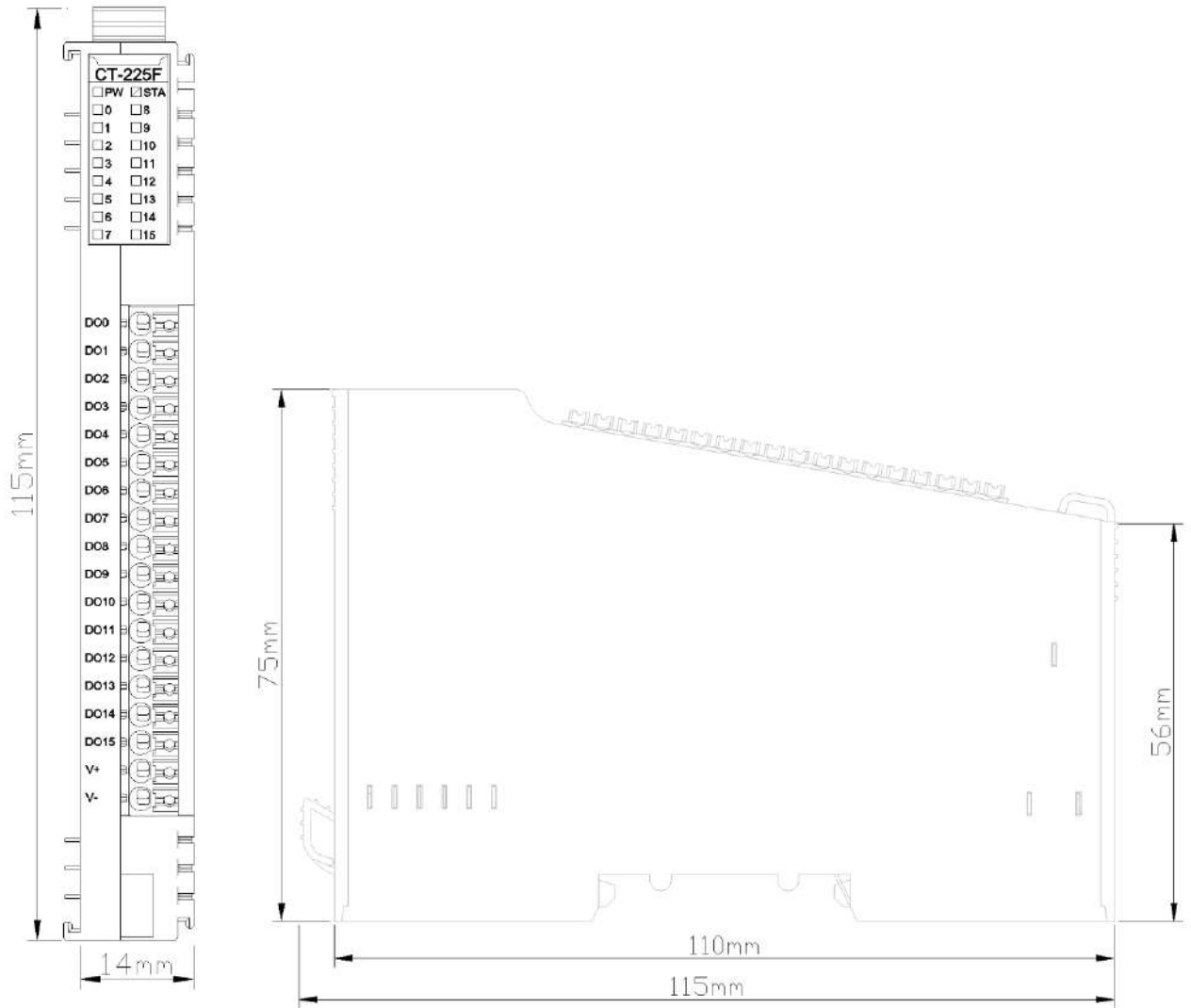

CT-226F 16 channels digital output/24VDC/PNP

1 Module features

- ◆ The module supports 16 channels digital output, the output voltage is 24VDC and the output high level is valid.
- ◆ The module can drive field equipment (relay, solenoid valve, etc.)
- ◆ The internal bus and field output of the module both adopt electromagnetic isolation
- ◆ The module carries 16 digital output channel LED indicator
- ◆ The module has the function of thermal shutdown and over current protection
- ◆ The module supports short circuit protection and overload protection
- ◆ The module output channel loop power supply requires 24VDC external power supply.

2 Technical parameters

General Parameters	
Power	Max.60mA@5.0VDC
Isolation	The isolation voltage between the I/O channel and the system power supply: AC500V The isolation voltage between the I/O channel and the field power supply: AC500V Isolation voltage between the I/O channel and PE: AC 500V
Field Power	Nominal:24VDC, Range:20.4-28.8VDC Alarm when the voltage is lower than 15~17V
Wiring	Max.: AWG 18 Min.: AWG 24
Installation	35mm DIN-Rail
Size	115*14*75mm
Weight	80g
Environment Specification	
Operating Temperature of Horizontal Installation	-35°C~70°C
Operating Temperature of Vertical Installation	-35°C~60°C
Relative Humidity	< 95%RH (No Condensation)
Storage Temperature	-40°C~85°C
Storage Humidity	< 95%RH (No Condensation)
Manufacturing Test Temperature	-40°C~75°C
Ingress Protection Rating	IP20
Output Parameters	
Channel Number	16 channel sink type output
LED Indicator	16 channel output LED indicator
Rated Current	single channel output: Max.1000mA simultaneously output: Max.500mA
Leakage Current	Max. 5uA
On Resistance	Typical value: 200mΩ
Output Delay	OFF to ON: Max.100us ON to OFF: Max.150us
Protection Function	Over-temperature shut down: typical value 150°C Overcurrent protection: typical value 1.3~1.8A Short circuit protection: supported Channel independent protection
Output Type	Source / High-side output
Load type	General use and Resistive, Pilot Duty
EMC parameters	
Static Electricity	Air 8KV/ Contact 6KV
EFT	1KV

 **WARNING**

UNEXPECTED EQUIPMENT OPERATION

Do not exceed any of the ratings specified in the environmental and electrical characteristics table.

Failure to follow instructions specified by the manufacturer may result in serious consequences such as death, personal injury, or damage to equipment since the protection provided by the equipment may be impaired.

 **AVERTISSEMENT**

FONCTIONNEMENT INATTENDU DE L'EQUIPEMENT

Ne dépassez aucune évaluation spécifiée dans le tableau de caractéristiques environnementales et électriques..

Le fait de ne pas suivre les instructions peut entraîner une défaillance de la protection fournie par l'équipement, ce qui peut entraîner des conséquences graves, comme des blessures ou des dommages à l'équipement.

3 Hardware interfaces

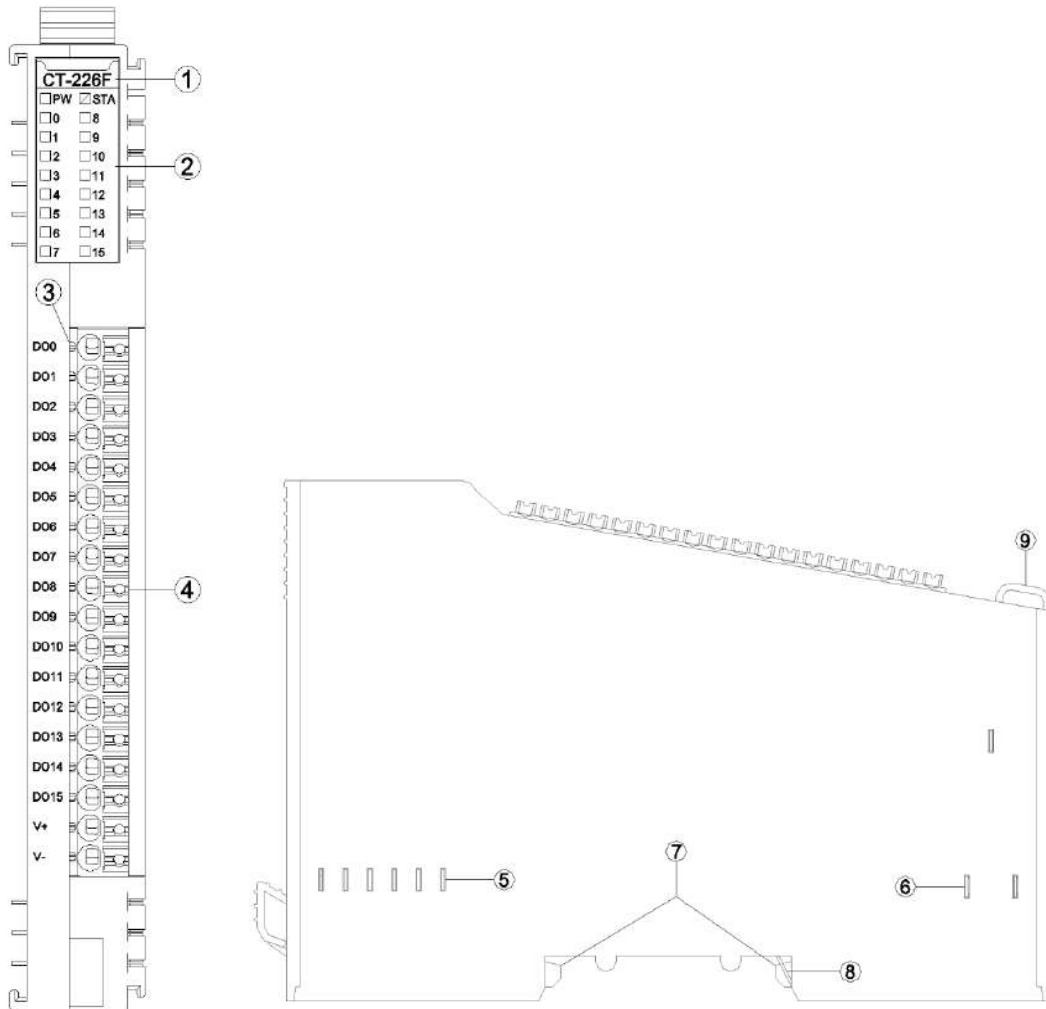

- ① Module Type
- ② State indicator
- ③ Channel indicator
- ④ Wiring Terminal and identification
- ⑤ Internal Bus
- ⑥ Field Power
- ⑦ Buckle
- ⑧ Grounding Spring Sheet
- ⑨ Fixed Wiring Harness

3.1 LED indicator definition

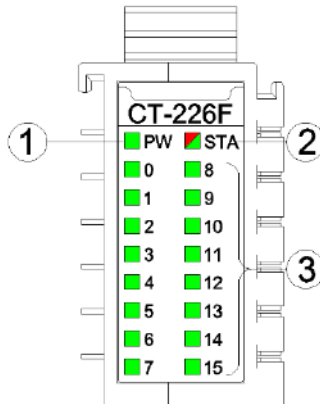

- ① Power LED indicator (green)
- ② Module State LED indicator (red/green)
- ③ Output channel LED indicator (green)

PW Power State (GREEN)	Definition
ON	Internal bus Power Normal
OFF	Internal bus Power Failure
STA Module State (RED/GREEN)	Definition
Green slow flash (2.5Hz)	Module internal bus is not started
Red slow flash (2.5Hz)	Module internal bus offline
ON (GREEN)	Operation normal
Flash(2.5Hz) (RED/GREEN)	Upgrading mode
Flash(10Hz) (RED/GREEN)	Firmware Update
Double Flash (RED)	Module Exception has been soft-restarted
0-15 channel indicator light	Definition
ON	Output signal valid
OFF	Output signal invalid

⚠ WARNING

UNEXPECTED EQUIPMENT OPERATION

By viewing the PW indicator, could determine the power supply status of a module. If the PW is steady green, the power supply is normal. Otherwise, the module cannot work properly.

When the module is initially powered on, there will be 3S for the backplane bus

connection. After the backplane bus is initialized, STA is in the green steady state. If STA is in the green blinking state, it indicates that the backplane bus has not been initialized, and it needs to be powered off and restarted for re-initialization.

STA abnormal working state occurs during the normal operation of the module, please check the firmware version information of all modules, and consult ODOT technical support for details.

If a module is upgraded, check that all modules are in the normal state after the upgrade. Otherwise, an exception may occur.

Failure to follow instructions specified by the manufacturer may result in serious consequences such as death, personal injury, or damage to equipment since the protection provided by the equipment may be impaired.

AVERTISSEMENT

FONCTIONNEMENT INATTENDU DE L'ÉQUIPEMENT

En regardant l'état de l'indicateur de PW, jugez l'état d'alimentation du module. Le feu vert PW reste allumé et l'alimentation est normale. Autrement, le module ne fonctionnera pas correctement.

Lorsque le module est alimenté initialement, il y aura 3S pour la connexion de bus de backboard. STA est un état vert permanent après l'initialisation du bus de backboard. Si STA est en état de clignotement vert, cela signifie que l'initialisation du bus de backboard n'est pas passée et doit être redémarrée hors tension et réinitialisée.

L'état de fonctionnement anormal de STA se produit pendant le fonctionnement normal du module, veuillez vérifier les informations de version du firmware de tous les modules, et consulter le support technique ODOT pour plus de détails.

Si le module a une opération de mise à niveau, après l'achèvement de la mise à niveau, le besoin de vérifier que tous les modules sont dans l'état normal avant de courir, sinon il conduira à une exception.

Le fait de ne pas suivre les instructions peut entraîner une défaillance de la protection fournie par l'équipement, ce qui peut entraîner des conséquences

graves, comme des blessures ou des dommages à l'équipement.

3.2 Field channel LED indicator (Green)

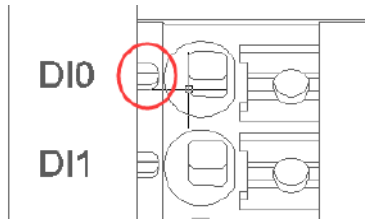

When output signal of output channel is valid, the corresponding field channel LED indicator is on.

3.3 Terminal definition

Terminal Number	Symbol	Description
1	DI0	Signal output
2	DI1	
3	DI2	
4	DI3	
5	DI4	
6	DI5	
7	DI6	
8	DI7	
9	DI8	Signal output
10	DI9	
11	DI10	
12	DI11	
13	DI12	
14	DI13	
15	DI14	
16	DI15	
17	V+	Power input (<i>Note</i>)
18	V-	Power input

Note:

When V+ and V- terminals are connected to the power supply at the same time, the sum of the current of all output channels is a maximum of 8A.

WARNING

UNEXPECTED EQUIPMENT OPERATION

Calculate the maximum field power current consumption of a single module based on the actual field load. If the total field power current consumption of all I/O modules exceeds the power supply

capacity of the field power supply, you must add an extra power expansion module. Otherwise, an output channel exception may occur.

Failure to follow instructions specified by the manufacturer may result in serious consequences such as death, personal injury, or damage to equipment since the protection provided by the equipment may be impaired.

! AVERTISSEMENT

FONCTIONNEMENT INATTENDU DE L'EQUIPEMENT

Calculez la consommation maximale de courant de champ d'un seul module en fonction de la charge de champ réelle. Si la consommation totale de courant de champ de tous les modules d'E/S dépasse la capacité d'alimentation de l'alimentation de champ, vous devez ajouter un module d'extension de puissance supplémentaire. Dans le cas contraire, une exception de canal de sortie peut se produire.

Le fait de ne pas suivre les instructions peut entraîner une défaillance de la protection fournie par l'équipement, ce qui peut entraîner des conséquences graves, comme des blessures ou des dommages à l'équipement.

When connecting a cold-pressed terminal, the terminal must be terminated and checked in strict accordance with the corresponding termination specifications or requirements, and connect the cold-pressed terminal according to the corresponding node serial number. The conductor should use copper conductor and the conductor core should be larger than 0.2mm^2 and smaller than 1mm^2 (AWG18~AWG24). Cold-pressed terminal parameters are as follows:

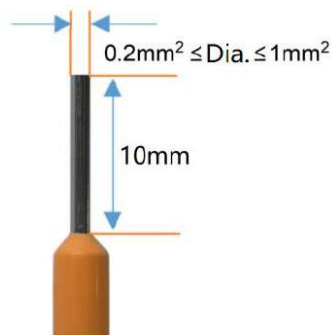

! WARNING

UNEXPECTED EQUIPMENT OPERATION

Strip the length of the conductor insulation layer is greater than 10mm to ensure reliable signal connection.

The wire needs to use copper wire and the wire core is greater than or equal to 0.2mm^2 and less than or equal to 1mm^2 to ensure reliable signal connection.

When connecting a cold-press terminal, connect the cold-press terminal strictly in accordance with the corresponding termination specifications or requirements, and connect the cold-press terminal according to the corresponding node serial number.

Do not power on cold-press terminals until they are properly connected or fully locked.

Failure to follow instructions specified by the manufacturer may result in serious consequences such as death, personal injury, or damage to equipment since the protection provided by the equipment may be impaired.

AVERTISSEMENT

FONCTIONNEMENT INATTENDU DE L'EQUIPEMENT

Dépouillez la longueur de la couche isolante du fil plus de 10mm pour assurer la connexion fiable du signal.

Le conducteur doit utiliser le fil de cuivre et le noyau de fil est supérieur ou égal à 0,2 mm², inférieur ou égal à 1mm², afin d'assurer la connexion fiable du signal.

Lorsque les terminaux de presse à froid sont terminés, ils doivent être terminés et visualisés en stricte conformité avec les spécifications ou les exigences correspondantes et terminés selon le numéro de série de noeud correspondant.

Il est interdit d'activer les bornes à froid avant qu'elles ne soient correctement articulées ou complètement verrouillées.

Le fait de ne pas suivre les instructions peut entraîner une défaillance de la protection fournie par l'équipement, ce qui peut entraîner des conséquences graves, comme des blessures ou des dommages à l'équipement.

DANGER

FIRE DANGER

Use the correct wiring rules only for the maximum current capacity of the I/O channel and power supply.

Failure to follow instructions specified by the manufacturer may result in

serious consequences such as death, personal injury, or damage to equipment since the protection provided by the equipment may be impaired.

 **WARNING**

UNEXPECTED EQUIPMENT OPERATION

Do not exceed any of the ratings specified in the environmental and electrical characteristics table.

Failure to follow instructions specified by the manufacturer may result in serious consequences such as death, personal injury, or damage to equipment since the protection provided by the equipment may be impaired.

 **AVERTISSEMENT**

FONCTIONNEMENT INATTENDU DE L'EQUIPEMENT

Ne dépassez aucune évaluation spécifiée dans le tableau de caractéristiques environnementales et électriques..

Le fait de ne pas suivre les instructions peut entraîner une défaillance de la protection fournie par l'équipement, ce qui peut entraîner des conséquences graves, comme des blessures ou des dommages à l'équipement.

4 Wiring

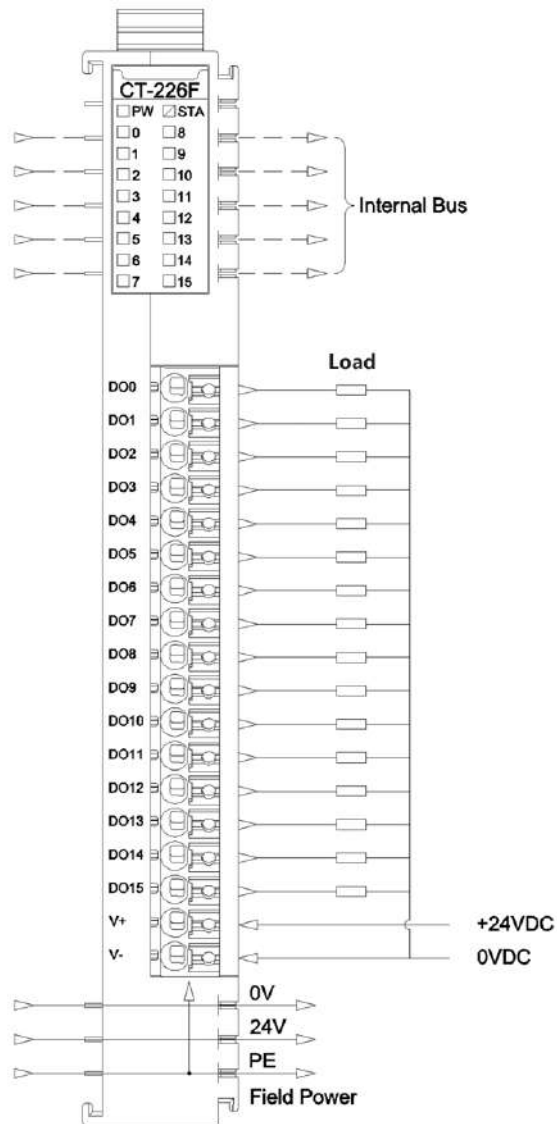

NOTICE

EQUIPMENT INOPERABLE

Do not crimp the spring terminal with more than the maximum pressure specified for the terminal. Otherwise, the resilience of the spring terminal may be damaged and the terminal rebound may be affected.

Do not press the spring terminal with a sharp tool when removing cable from the channel. Otherwise, the spring terminal will be damaged.

Failure to follow these instructions may result in equipment damage.

5 Process data definition

Output data								
Bit No	Bit 7	Bit 6	Bit 5	Bit 4	Bit 3	Bit 2	Bit 1	Bit 0
Byte 0	DO Ch#7	DO Ch#6	DO Ch#5	DO Ch#4	DO Ch#3	DO Ch#2	DO Ch#1	DO Ch#0
Byte 1	DO Ch#15	DO Ch#14	DO Ch#13	DO Ch#12	DO Ch#11	DO Ch#10	DO Ch#9	DO Ch#8

Data description:

DI Ch#(0-15): When the corresponding channel output signal is valid, the bit is 1, and when the input is invalid, it is 0.

0: Output signal invalid

1: Output signal valid

6 Configuration parameter definitions

Configuration parameters								
Bit No	Bit 7	Bit 6	Bit 5	Bit 4	Bit 3	Bit 2	Bit 1	Bit 0
Byte 0	Fault Action for Output Ch#7	Fault Action for Output Ch#6	Fault Action for Output Ch#5	Fault Action for Output Ch#4	Fault Action for Output Ch#3	Fault Action for Output Ch#2	Fault Action for Output Ch#1	Fault Action for Output Ch#0
Byte 1	Fault Action for Output Ch#15	Fault Action for Output Ch#14	Fault Action for Output Ch#13	Fault Action for Output Ch#12	Fault Action for Output Ch#11	Fault Action for Output Ch#10	Fault Action for Output Ch#9	Fault Action for Output Ch#8
Byte 2	Fault Value for Output Ch#7	Fault Value for Output Ch#6	Fault Value for Output Ch#5	Fault Value for Output Ch#4	Fault Value for Output Ch#3	Fault Value for Output Ch#2	Fault Value for Output Ch#1	Fault Value for Output Ch#0
Byte 3	Fault Value for Output Ch#15	Fault Value for Output Ch#14	Fault Value for Output Ch#13	Fault Value for Output Ch#12	Fault Value for Output Ch#11	Fault Value for Output Ch#10	Fault Value for Output Ch#9	Fault Value for Output Ch#8

Data description:

Fault Action for Output Ch#(0-15): Fault Output mode. When the IO module detects an internal bus exception and fails to communicate with the adapter. And the module will turn to offline mode, so the output data is processed in this way. (default: 0)

0: keep the last time output State.

1: output fault value.

Fault Value for Output Ch#(0-15): When the Fault Output mode is 1, this bit sets the Fault Output Value, and this setting value will be outputted when the internal bus of IO module is offline. (default: 0)

0: Output low level.

1: Output high level.

A Dimension drawing

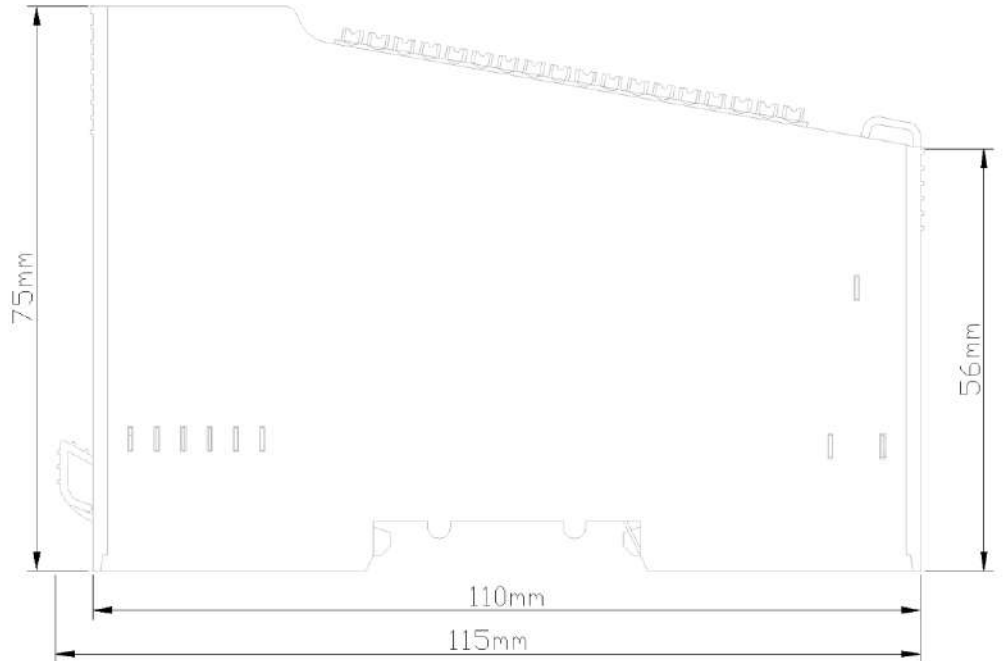
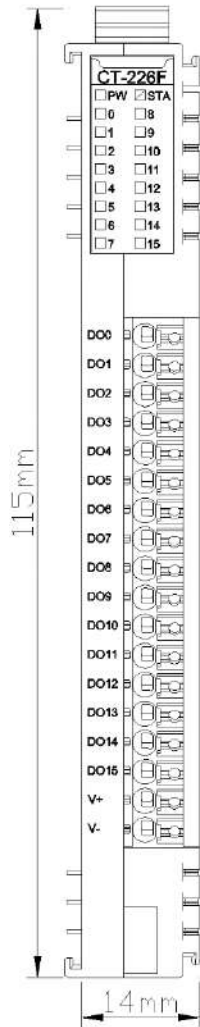

CT-2718 8 channels relay output 1A/30VDC/30W

1 Module features

- ◆ 8-channel relay normally on output
- ◆ 8 LED channel indicators
- ◆ Low on resistance ($\leq 100\text{m}\Omega$)
- ◆ The max. switch voltage is 30VDC

2 Technical Parameters

General Parameters	
Power Consumption	Max.280mA@5.0VDC
Isolation	I/O to internal bus: coil isolation(1600VAC)
Field Power	Not used
Wiring	Max.: AWG 18 Min.: AWG 24
Installation	35mm DIN-Rail
Size	115*14*75mm
Weight	65g
Environment Specification	
Operating Temperature of Horizontal Installation	-35°C~70°C
Operating Temperature of Vertical Installation	-35°C~60°C
Relative Humidity	< 95%RH (No Condensation)
Storage Temperature	-40°C~85°C
Storage Humidity	< 95%RH (No Condensation)
Manufacturing Test Temperature	-40°C~75°C
Ingress Protection Rating	IP20
Output Parameter	
Channel Number	8 channel relay normally on output
LED Indicator	8 channel output LED Indicator
Max. Switching Current	1A
Max. Switching Voltage	30VDC
Max. Switching Power	30W
Contact Resistance	≤100mΩ
Output Delay	ON to OFF:Max.3ms OFF to ON:Max.3ms
Mechanical Endurance	1x10 ⁸
Electricity Endurance	1x10 ⁵
Vibration	10Hz~55Hz 3.3mm Double vibration amplitude
Impact	Stability: 735m/s ² Strength: 980m/s ²
Load type	Resistive, Pilot Duty

 **WARNING**

UNEXPECTED EQUIPMENT OPERATION

Do not exceed any of the ratings specified in the environmental and electrical characteristics table.

Failure to follow instructions specified by the manufacturer may result in serious consequences such as death, personal injury, or damage to equipment since the protection provided by the equipment may be impaired.

 **AVERTISSEMENT**

FONCTIONNEMENT INATTENDU DE L'EQUIPEMENT

Ne dépassez aucune évaluation spécifiée dans le tableau de caractéristiques environnementales et électriques.

Le fait de ne pas suivre les instructions peut entraîner une défaillance de la protection fournie par l'équipement, ce qui peut entraîner des conséquences graves, comme des blessures ou des dommages à l'équipement.

3 Hardware Interface

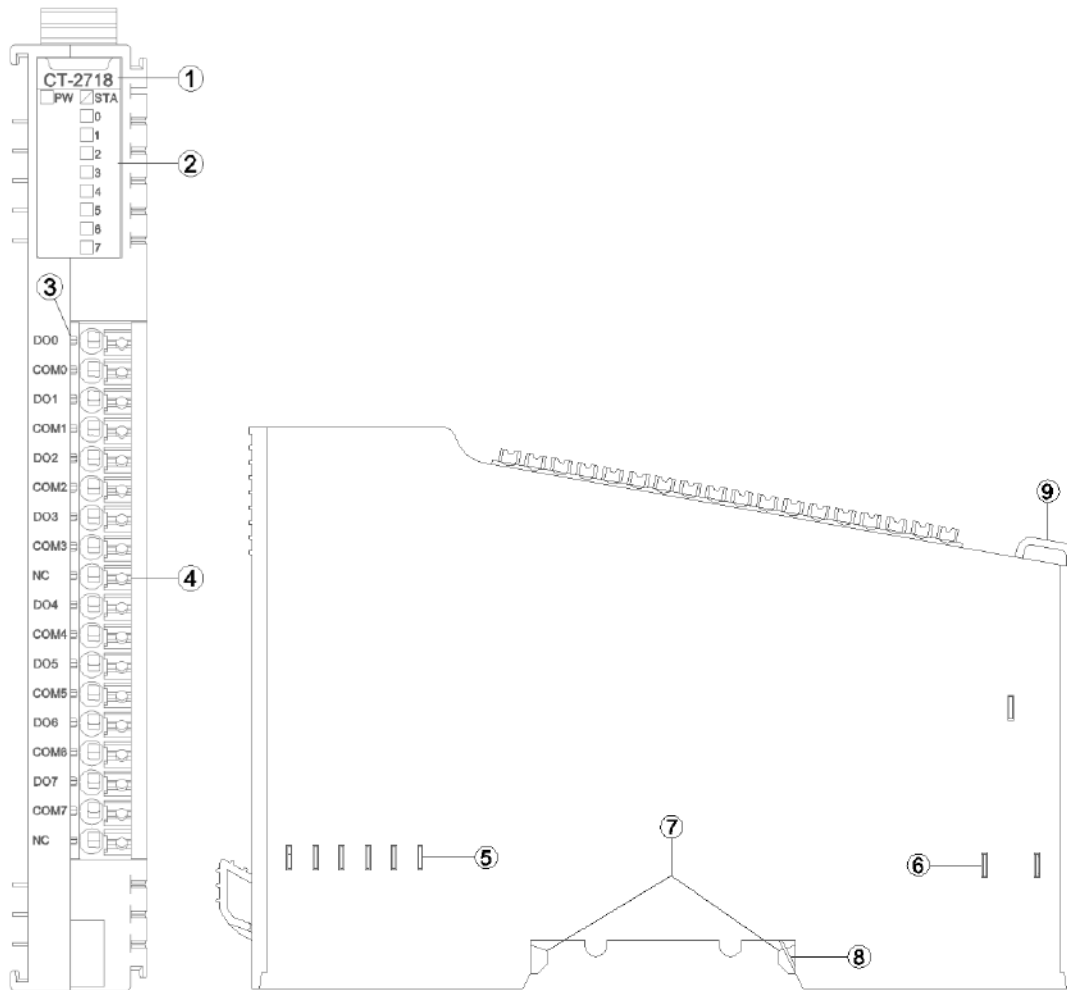

- ① Module Type
- ② State indicator
- ③ N/A
- ④ Wiring Terminal and identification
- ⑤ Internal Bus
- ⑥ Field Power
- ⑦ Buckle
- ⑧ Grounding Spring Sheet
- ⑨ Fixed Wiring Harness

3.1 LED indicator definition

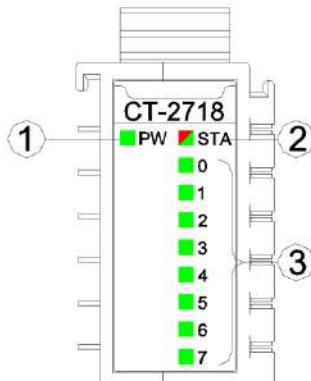

- ① Power LED indicator (green)
- ② Module State LED indicator (red/green)
- ③ Output channel LED indicator (green)

PW Power State (GREEN)	Definition
ON	Internal bus Power Normal
OFF	Internal bus Power Failure
STA Module State (RED/GREEN)	Definition
Green slow flash (2.5Hz)	Module internal bus is not started
Red slow flash (2.5Hz)	Module internal bus offline
ON (GREEN)	Operation normal
Flash(2.5Hz) (RED/GREEN)	Upgrading mode
Flash(10Hz) (RED/GREEN)	Firmware Update
Double Flash (RED)	Module Exception, has been soft-restarted
0-7 channel LED indicator (GREEN)	Definition
ON	Output signal valid
OFF	Output signal invalid

! WARNING

UNEXPECTED EQUIPMENT OPERATION

By viewing the PW indicator, could determine the power supply status of a module. If the PW is steady green, the power supply is normal. Otherwise, the module cannot work properly.

When the module is initially powered on, there will be 3S for the backplane bus connection. After the backplane bus is initialized, STA is in the green steady state. If STA is in the green blinking state, it indicates that the backplane bus has not been initialized, and it needs to be powered off and restarted for re-initialization.

STA abnormal working state occurs during the normal operation of the module, please check the firmware version information of all modules, and consult ODOT technical support for details.

If a module is upgraded, check that all modules are in the normal state after the upgrade. Otherwise, an exception may occur.

Failure to follow instructions specified by the manufacturer may result in serious

consequences such as death, personal injury, or damage to equipment since the protection provided by the equipment may be impaired.

 **AVERTISSEMENT**

FONCTIONNEMENT INATTENDU DE L'EQUIPEMENT

En regardant l'état de l'indicateur de PW, jugez l'état d'alimentation du module. Le feu vert PW reste allumé et l'alimentation est normale. Autrement, le module ne fonctionnera pas correctement.

Lorsque le module est alimenté initialement, il y aura 3S pour la connexion de bus de backboard. STA est un état vert permanent après l'initialisation du bus de backboard. Si STA est en état de clignotement vert, cela signifie que l'initialisation du bus de backboard n'est pas passée et doit être redémarrée hors tension et réinitialisée.

L'état de fonctionnement anormal de STA se produit pendant le fonctionnement normal du module, veuillez vérifier les informations de version du firmware de tous les modules, et consulter le support technique ODOT pour plus de détails.

Si le module a une opération de mise à niveau, après l'achèvement de la mise à niveau, le besoin de vérifier que tous les modules sont dans l'état normal avant de courir, sinon il conduira à une exception.

Le fait de ne pas suivre les instructions peut entraîner une défaillance de la protection fournie par l'équipement, ce qui peut entraîner des conséquences graves, comme des blessures ou des dommages à l'équipement.

3.2 Terminal definition

Terminal Number	Definition	Description
1	DO0	Channel 0 output
2	COM0	Channel 0 Common Port
3	DO1	Channel 1 output
4	COM1	Channel 1 Common Port
5	DO2	Channel 2 output
6	COM2	Channel 2 Common Port
7	DO3	Channel 3 output
8	COM3	Channel 3 Common Port
9	NC	Not Connected
10	DO4	Channel 4 output
11	COM4	Channel 4 Common Port
12	DO5	Channel 5 output
13	COM5	Channel 5 Common Port
14	DO6	Channel 6 output
15	COM6	Channel 6 Common Port
16	DO7	Channel 7 output
17	COM7	Channel 7 Common Port
18	NC	Not Connected

WARNING

UNEXPECTED EQUIPMENT OPERATION

Calculate the maximum field power current consumption of a single module based on the actual field load. If the total field power current consumption of all I/O modules exceeds the power supply capacity of the field power supply, you must add an extra power expansion module. Otherwise, an output channel exception may occur.

Failure to follow instructions specified by the manufacturer may result in serious consequences such as death, personal injury, or damage to equipment since the protection provided by the equipment may be impaired.

AVERTISSEMENT

FONCTIONNEMENT INATTENDU DE L'EQUIPEMENT

Calculez la consommation maximale de courant de champ d'un seul module en fonction de la charge de champ réelle. Si la consommation totale de courant de champ de tous les modules d'E/S dépasse la capacité d'alimentation de l'alimentation de champ, vous devez ajouter un module d'extension de puissance supplémentaire. Dans le cas contraire, une exception de canal de sortie peut se produire.

Le fait de ne pas suivre les instructions peut entraîner une défaillance de la protection fournie par l'équipement, ce qui peut entraîner des conséquences graves, comme des blessures ou des dommages à l'équipement.

When connecting a cold-pressed terminal, the terminal must be terminated and checked in strict accordance with the corresponding termination specifications or requirements, and connect the cold-pressed terminal according to the corresponding node serial number. The conductor should use copper conductor and the conductor core should be larger than 0.2mm^2 and smaller than 1mm^2 (AWG18~AWG24). Cold-pressed terminal parameters are as follows:

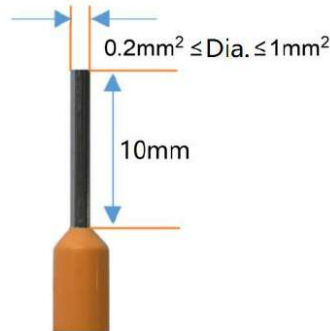

⚠ WARNING

UNEXPECTED EQUIPMENT OPERATION

Strip the length of the conductor insulation layer is greater than 10mm to ensure reliable signal connection.

The wire needs to use copper wire and the wire core is greater than or equal to 0.2mm^2 and less than or equal to 1mm^2 to ensure reliable signal connection.

When connecting a cold-press terminal, connect the cold-press terminal strictly in accordance with the corresponding termination specifications or requirements, and connect the cold-press terminal according to the corresponding node serial number.

Do not power on cold-press terminals until they are properly connected or fully locked.

Failure to follow instructions specified by the manufacturer may result in serious consequences such as death, personal injury, or damage to equipment since the protection provided by the equipment may be impaired.

⚠ AVERTISSEMENT

FONCTIONNEMENT INATTENDU DE L'EQUIPEMENT

Dépouillez la longueur de la couche isolante du fil plus de 10mm pour assurer la connexion fiable du signal.

Le conducteur doit utiliser le fil de cuivre et le noyau de fil est supérieur ou égal à $0,2\text{ mm}^2$, inférieur ou égal à 1mm^2 , afin d'assurer la connexion fiable du signal.

Lorsque les terminaux de presse à froid sont terminés, ils doivent être terminés et visualisés en stricte conformité avec les spécifications ou les exigences correspondantes et terminés selon le numéro de série de noeud correspondant.

Il est interdit d'activer les bornes à froid avant qu'elles ne soient correctement articulées ou complètement verrouillées.

Le fait de ne pas suivre les instructions peut entraîner une défaillance de la protection

fournie par l'équipement, ce qui peut entraîner des conséquences graves, comme des blessures ou des dommages à l'équipement.

DANGER

FIRE DANGER

Use the correct wiring rules only for the maximum current capacity of the I/O channel and power supply.

Failure to follow instructions specified by the manufacturer may result in serious consequences such as death, personal injury, or damage to equipment since the protection provided by the equipment may be impaired.

WARNING

UNEXPECTED EQUIPMENT OPERATION

Do not exceed any of the ratings specified in the environmental and electrical characteristics table.

Failure to follow instructions specified by the manufacturer may result in serious consequences such as death, personal injury, or damage to equipment since the protection provided by the equipment may be impaired.

AVERTISSEMENT

FONCTIONNEMENT INATTENDU DE L'EQUIPEMENT

Ne dépassez aucune évaluation spécifiée dans le tableau de caractéristiques environnementales et électriques..

Le fait de ne pas suivre les instructions peut entraîner une défaillance de la protection fournie par l'équipement, ce qui peut entraîner des conséquences graves, comme des blessures ou des dommages à l'équipement.

4 Wiring

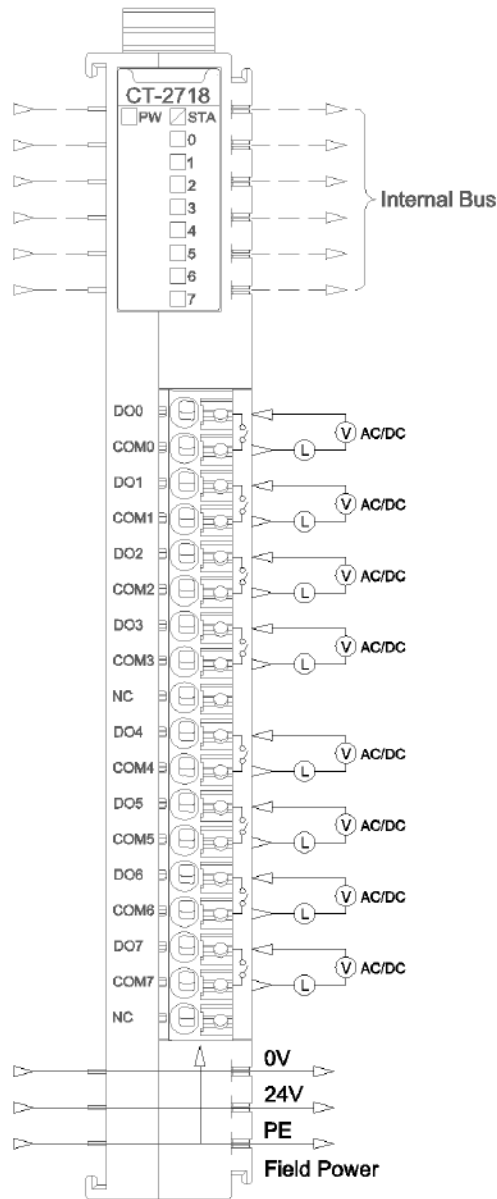

NOTICE

EQUIPMENT INOPERABLE

Do not crimp the spring terminal with more than the maximum pressure specified for the terminal. Otherwise, the resilience of the spring terminal may be damaged and the terminal rebound may be affected.

Do not press the spring terminal with a sharp tool when removing cable from the channel. Otherwise, the spring terminal will be damaged.

Failure to follow these instructions may result in equipment damage.

5 Process data definition

Output Data								
Bit No	Bit 7	Bit 6	Bit 5	Bit 4	Bit 3	Bit 2	Bit 1	Bit 0
Byte 0	DO Ch#7	DO Ch#6	DO Ch#5	DO Ch#4	DO Ch#3	DO Ch#2	DO Ch#1	DO Ch#0

Data description:

DO Ch#(0-7): When the bit is 1, the output signal of corresponding channel is effective and the output contact of relay is closed. When the bit is 0, the output is invalid and the relay contact is disconnected.

0: The output signal is invalid

1: The output signal is valid

6 Configuration parameters definition

Configuration parameters								
Bit No	Bit 7	Bit 6	Bit 5	Bit 4	Bit 3	Bit 2	Bit 1	Bit 0
Byte 0	Fault Action for Output Ch#7	Fault Action for Output Ch#6	Fault Action for Output Ch#5	Fault Action for Output Ch#4	Fault Action for Output Ch#3	Fault Action for Output Ch#2	Fault Action for Output Ch#1	Fault Action for Output Ch#0
Byte 1	Fault Value for Output Ch#7	Fault Value for Output Ch#6	Fault Value for Output Ch#5	Fault Value for Output Ch#4	Fault Value for Output Ch#3	Fault Value for Output Ch#2	Fault Value for Output Ch#1	Fault Value for Output Ch#0

Data description:

Fault Action for Output Ch#(0-7): Fault output mode. When IO module detects that internal bus communication is failed and enters offline mode, the output data will be processed in this mode. (Default: 0)

0: Hold the last output state.

1: Output fault value

Fault Value for Output Ch#(0-7): When the fault output mode is 1, this bit would set the fault output value, and when the internal bus of IO module is offline, this setting value will be output.(Default: 0)

0: Output low level.

1: Output high level.

A Dimension drawing

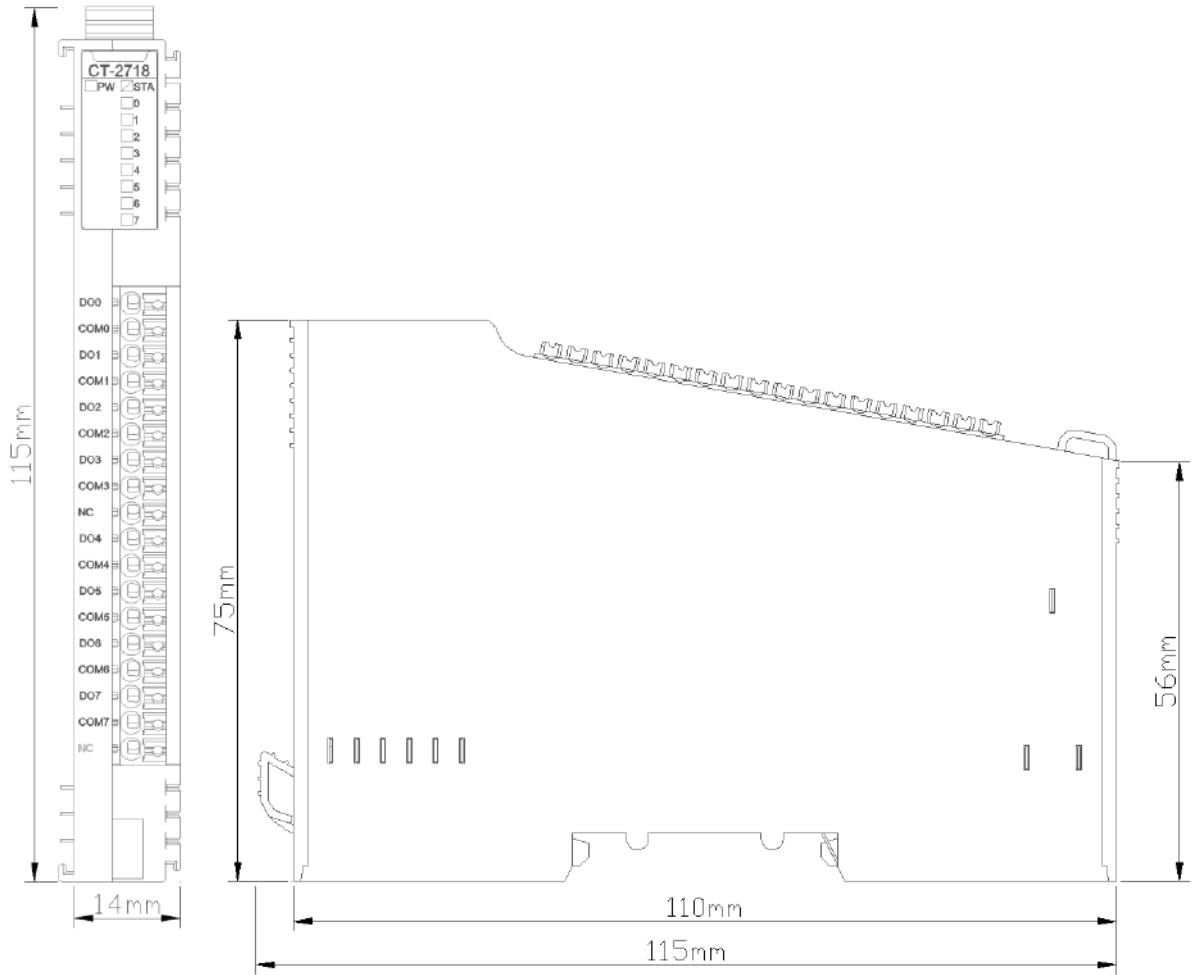

CT-2738 8 channels relay output 1A/30VDC/30W

1 Module features

- ◆ 8-channel relay normally on output
- ◆ 8 LED channel indicators
- ◆ Low on resistance ($\leq 100\text{m}\Omega$)
- ◆ With isolation between channels
- ◆ Built-in TVS bidirectional diode, built-in RC circuit
- ◆ Resistive and inductive loads can be connected

2 Technical Parameters

General Parameters	
Power Consumption	Max.250mA@5.0VDC
Isolation	I/O channel to internal Bus isolation voltage AC 500V Isolation voltage between channels AC 500V
Field Power	Not used
Wiring	Max.: AWG 18 Min.: AWG 24
Installation	35mm DIN-Rail
Size	115*14*75mm
Weight	65g
Vibration Resistance	Comply with IEC 61131-2 and EC 60068-2-6
Impact resistance	Comply with IEC 61131-2 and IEC 60068-2-27
EMC Performance	Comply with IEC 61131-2 and IEC 61000-4
Environment Specification	
Operating Temperature of Horizontal Installation	-35°C~70°C
Operating Temperature of Vertical Installation	-35°C~60°C
Relative Humidity	< 95%RH (No Condensation)
Storage Temperature	-40°C~85°C
Storage Humidity	< 95%RH (No Condensation)
Manufacturing Test Temperature	-40°C~75°C
Ingress Protection Rating	IP20
Output Parameter	
Channel Number	8 channel Relay normally on output
LED Indicator	8 channel output LED Indicator
Max. Switching Current	Resistive load: 1A Inductive load: 1A
Max. Switching Voltage	30VDC
Max. Switching Power	30W
Switching Frequency	Resistive load: Max 2Hz Inductive load: Max 0.5Hz
Contact Resistance	≤100mΩ
Output Delay	ON to OFF: Max.10ms OFF to ON: Max.10ms
Mechanical Endurance	2x10 ⁷
Electricity Endurance	1x10 ⁵
Vibration	10Hz~55Hz 1.5mm Double vibration amplitude

Impact	Stability: 98m/s ² Strength: 980m/s ²
Load type	General use and Resistive, Pilot Duty

 WARNING

UNEXPECTED EQUIPMENT OPERATION

Do not exceed any of the ratings specified in the environmental and electrical characteristics table.

Failure to follow instructions specified by the manufacturer may result in serious consequences such as death, personal injury, or damage to equipment since the protection provided by the equipment may be impaired.

 AVERTISSEMENT

FONCTIONNEMENT INATTENDU DE L'EQUIPEMENT

Ne dépassez aucune évaluation spécifiée dans le tableau de caractéristiques environnementales et électriques.

Le fait de ne pas suivre les instructions peut entraîner une défaillance de la protection fournie par l'équipement, ce qui peut entraîner des conséquences graves, comme des blessures ou des dommages à l'équipement.

3 Hardware Interface

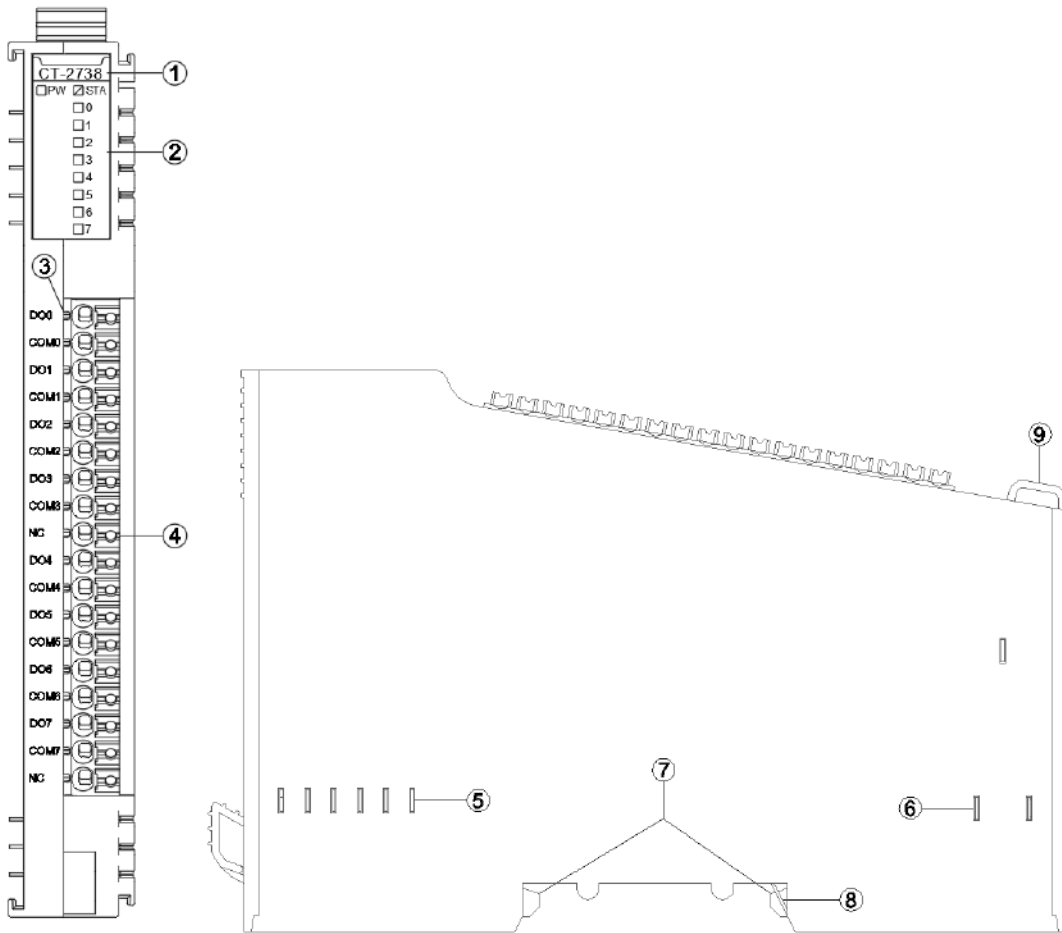

- ① Module Type
- ② State indicator
- ③ N/A
- ④ Wiring Terminal and identification
- ⑤ Internal Bus
- ⑥ Field Power
- ⑦ Buckle
- ⑧ Grounding Spring Sheet
- ⑨ Fixed Wiring Harness

3.1 LED Indicator definition

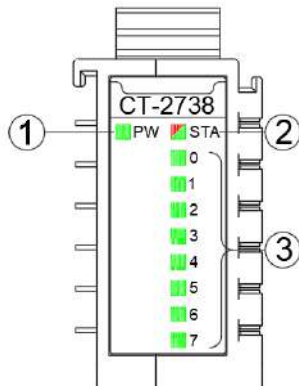

- ① Power LED indicator (green)
- ② Module State LED indicator (red/green)
- ③ Output channel LED indicator (green)

PW Power State (RED)	Definition
ON	Internal bus Power Normal
OFF	Internal bus Power Failure
STA Module State (RED/GREEN)	Definition
Green slow flash (2.5Hz)	Module internal bus is not started
Red slow flash (2.5Hz)	Module internal bus offline
ON (GREEN)	Operation normal
Flash(2.5Hz) (RED/GREEN)	Upgrading mode
Flash(10Hz) (RED/GREEN)	Firmware Update
Double Flash (RED)	Module Exception, has been soft-restarted
0-7 channel LED indicator (GREEN)	Definition
ON	Output signal valid
OFF	Output signal invalid

⚠ WARNING

UNEXPECTED EQUIPMENT OPERATION

By viewing the PW indicator, could determine the power supply status of a module. If the PW is steady green, the power supply is normal. Otherwise, the module cannot work properly.

When the module is initially powered on, there will be 3S for the backplane bus connection. After the backplane bus is initialized, STA is in the green steady state. If STA is in the green blinking state, it indicates that the backplane bus has not been initialized, and it needs to be powered off and restarted for re-initialization.

STA abnormal working state occurs during the normal operation of the module, please check the firmware version information of all modules, and consult ODOT technical support for details.

If a module is upgraded, check that all modules are in the normal state after the upgrade. Otherwise, an exception may occur.

Failure to follow instructions specified by the manufacturer may result in serious consequences such as death, personal injury, or damage to equipment since the protection provided by the equipment may be impaired.

 AVERTISSEMENT

FONCTIONNEMENT INATTENDU DE L'EQUIPEMENT

En regardant l'état de l'indicateur de PW, jugez l'état d'alimentation du module. Le feu vert PW reste allumé et l'alimentation est normale. Autrement, le module ne fonctionnera pas correctement.

Lorsque le module est alimenté initialement, il y aura 3S pour la connexion de bus de backboard. STA est un état vert permanent après l'initialisation du bus de backboard. Si STA est en état de clignotement vert, cela signifie que l'initialisation du bus de backboard n'est pas passée et doit être redémarrée hors tension et réinitialisée.

L'état de fonctionnement anormal de STA se produit pendant le fonctionnement normal du module, veuillez vérifier les informations de version du firmware de tous les modules, et consulter le support technique ODOT pour plus de détails.

Si le module a une opération de mise à niveau, après l'achèvement de la mise à niveau, le besoin de vérifier que tous les modules sont dans l'état normal avant de courir, sinon il conduira à une exception.

Le fait de ne pas suivre les instructions peut entraîner une défaillance de la protection fournie par l'équipement, ce qui peut entraîner des conséquences graves, comme des blessures ou des dommages à l'équipement.

3.2 Terminal definition

Terminal Number	Definition	Description
1	DO0	Channel 0 output
2	COM0	Channel 0 Common Port
3	DO1	Channel 1 output
4	COM1	Channel 1 Common Port
5	DO2	Channel 2 output
6	COM2	Channel 2 Common Port
7	DO3	Channel 3 output
8	COM3	Channel 3 Common Port
9	NC	Not Connected
10	DO4	Channel 4 output
11	COM4	Channel 4 Common Port
12	DO5	Channel 5 output
13	COM5	Channel 5 Common Port
14	DO6	Channel 6 output
15	COM6	Channel 6 Common Port
16	DO7	Channel 7 output
17	COM7	Channel 7 Common Port
18	NC	Not Connected

WARNING

UNEXPECTED EQUIPMENT OPERATION

Calculate the maximum field power current consumption of a single module based on the actual field load. If the total field power current consumption of all I/O modules exceeds the power supply capacity of the field power supply, you must add an extra power expansion module. Otherwise, an output channel exception may occur.

Failure to follow instructions specified by the manufacturer may result in serious consequences such as death, personal injury, or damage to equipment since the protection provided by the equipment may be impaired.

AVERTISSEMENT

FONCTIONNEMENT INATTENDU DE L'EQUIPEMENT

Calculez la consommation maximale de courant de champ d'un seul module en fonction de la charge de champ réelle. Si la consommation totale de courant de champ de tous les modules d'E/S dépasse la capacité d'alimentation de l'alimentation de champ, vous devez ajouter un module d'extension de puissance supplémentaire. Dans le cas contraire, une exception de canal de sortie peut se produire.

Le fait de ne pas suivre les instructions peut entraîner une défaillance de la protection fournie par l'équipement, ce qui peut entraîner des conséquences graves, comme des blessures ou des dommages à l'équipement.

When connecting a cold-pressed terminal, the terminal must be terminated and checked in strict accordance with the corresponding termination specifications or requirements, and connect the cold-pressed terminal according to the corresponding node serial number. The conductor should use copper conductor and the conductor core should be larger than 0.2mm^2 and smaller than 1mm^2 (AWG18~AWG24). Cold-pressed terminal parameters are as follows:

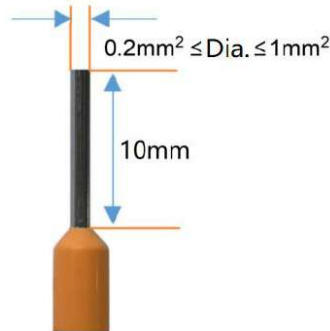

⚠ WARNING

UNEXPECTED EQUIPMENT OPERATION

Strip the length of the conductor insulation layer is greater than 10mm to ensure reliable signal connection.

The wire needs to use copper wire and the wire core is greater than or equal to 0.2mm^2 and less than or equal to 1mm^2 to ensure reliable signal connection.

When connecting a cold-press terminal, connect the cold-press terminal strictly in accordance with the corresponding termination specifications or requirements, and connect the cold-press terminal according to the corresponding node serial number.

Do not power on cold-press terminals until they are properly connected or fully locked.

Failure to follow instructions specified by the manufacturer may result in serious consequences such as death, personal injury, or damage to equipment since the protection provided by the equipment may be impaired.

⚠ AVERTISSEMENT

FONCTIONNEMENT INATTENDU DE L'EQUIPEMENT

Dépouillez la longueur de la couche isolante du fil plus de 10mm pour assurer la connexion fiable du signal.

Le conducteur doit utiliser le fil de cuivre et le noyau de fil est supérieur ou égal à $0,2\text{ mm}^2$, inférieur ou égal à 1mm^2 , afin d'assurer la connexion fiable du signal.

Lorsque les terminaux de presse à froid sont terminés, ils doivent être terminés et visualisés en stricte conformité avec les spécifications ou les exigences correspondantes et terminés selon le numéro de série de noeud correspondant.

Il est interdit d'activer les bornes à froid avant qu'elles ne soient correctement articulées ou complètement verrouillées.

Le fait de ne pas suivre les instructions peut entraîner une défaillance de la protection

fournie par l'équipement, ce qui peut entraîner des conséquences graves, comme des blessures ou des dommages à l'équipement.

DANGER

FIRE DANGER

Use the correct wiring rules only for the maximum current capacity of the I/O channel and power supply.

Failure to follow instructions specified by the manufacturer may result in serious consequences such as death, personal injury, or damage to equipment since the protection provided by the equipment may be impaired.

WARNING

UNEXPECTED EQUIPMENT OPERATION

Do not exceed any of the ratings specified in the environmental and electrical characteristics table.

Failure to follow instructions specified by the manufacturer may result in serious consequences such as death, personal injury, or damage to equipment since the protection provided by the equipment may be impaired.

AVERTISSEMENT

FONCTIONNEMENT INATTENDU DE L'EQUIPEMENT

Ne dépassez aucune évaluation spécifiée dans le tableau de caractéristiques environnementales et électriques..

Le fait de ne pas suivre les instructions peut entraîner une défaillance de la protection fournie par l'équipement, ce qui peut entraîner des conséquences graves, comme des blessures ou des dommages à l'équipement.

4 Wiring

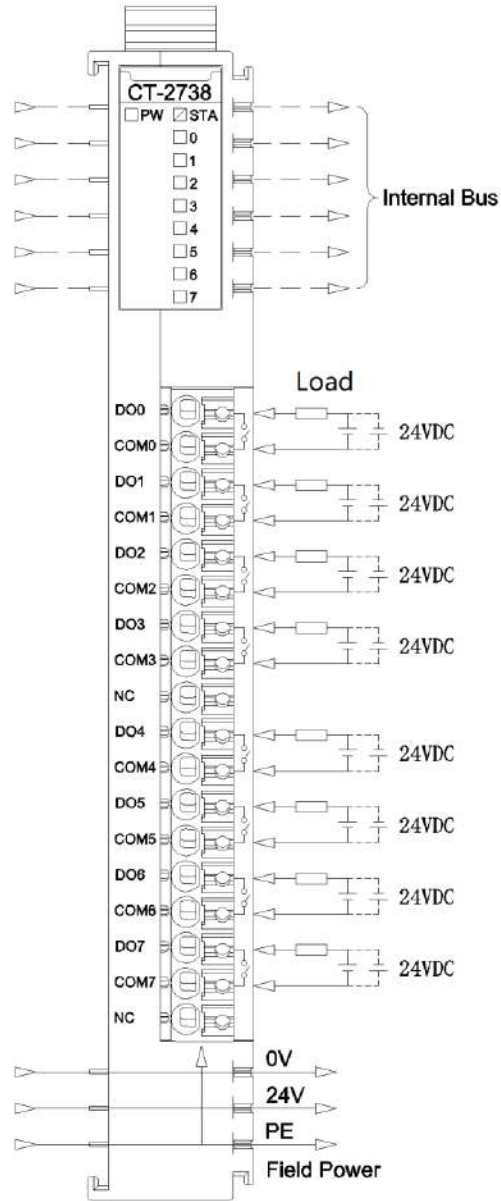

NOTICE

EQUIPMENT INOPERABLE

Do not crimp the spring terminal with more than the maximum pressure specified for the terminal. Otherwise, the resilience of the spring terminal may be damaged and the terminal rebound may be affected.

Do not press the spring terminal with a sharp tool when removing cable from the channel. Otherwise, the spring terminal will be damaged.

Failure to follow these instructions may result in equipment damage.

5 Process data definition

Output Data								
Bit No	Bit 7	Bit 6	Bit 5	Bit 4	Bit 3	Bit 2	Bit 1	Bit 0
Byte 0	DO Ch#7	DO Ch#6	DO Ch#5	DO Ch#4	DO Ch#3	DO Ch#2	DO Ch#1	DO Ch#0

Data description :

DO Ch#(0-7): When the bit is 1, the output signal of corresponding channel is effective and the output contact of relay is closed. When the bit is 0, the output is invalid and the relay contact is disconnected.

0: The output signal is invalid

1: The output signal is valid

6 Configuration parameters definition

Configuration parameters								
Bit No	Bit 7	Bit 6	Bit 5	Bit 4	Bit 3	Bit 2	Bit 1	Bit 0
Byte 0	Fault Action for Output Ch#7	Fault Action for Output Ch#6	Fault Action for Output Ch#5	Fault Action for Output Ch#4	Fault Action for Output Ch#3	Fault Action for Output Ch#2	Fault Action for Output Ch#1	Fault Action for Output Ch#0
Byte 1	Fault Value for Output Ch#7	Fault Value for Output Ch#6	Fault Value for Output Ch#5	Fault Value for Output Ch#4	Fault Value for Output Ch#3	Fault Value for Output Ch#2	Fault Value for Output Ch#1	Fault Value for Output Ch#0

Data description:

Fault Action for Output Ch#(0-7): Fault output mode. When IO module detects that internal bus communication is failed and enters offline mode, the output data will be processed in this mode. (Default: 0)

0: Hold the last output state.

1: Output fault value

Fault Value for Output Ch#(0-7): When the fault output mode is 1, this bit would set the fault output value, and when the internal bus of IO module is offline, this setting value will be output. (Default: 0)

0: Output low level.

1: Output high level.

A Dimension drawing

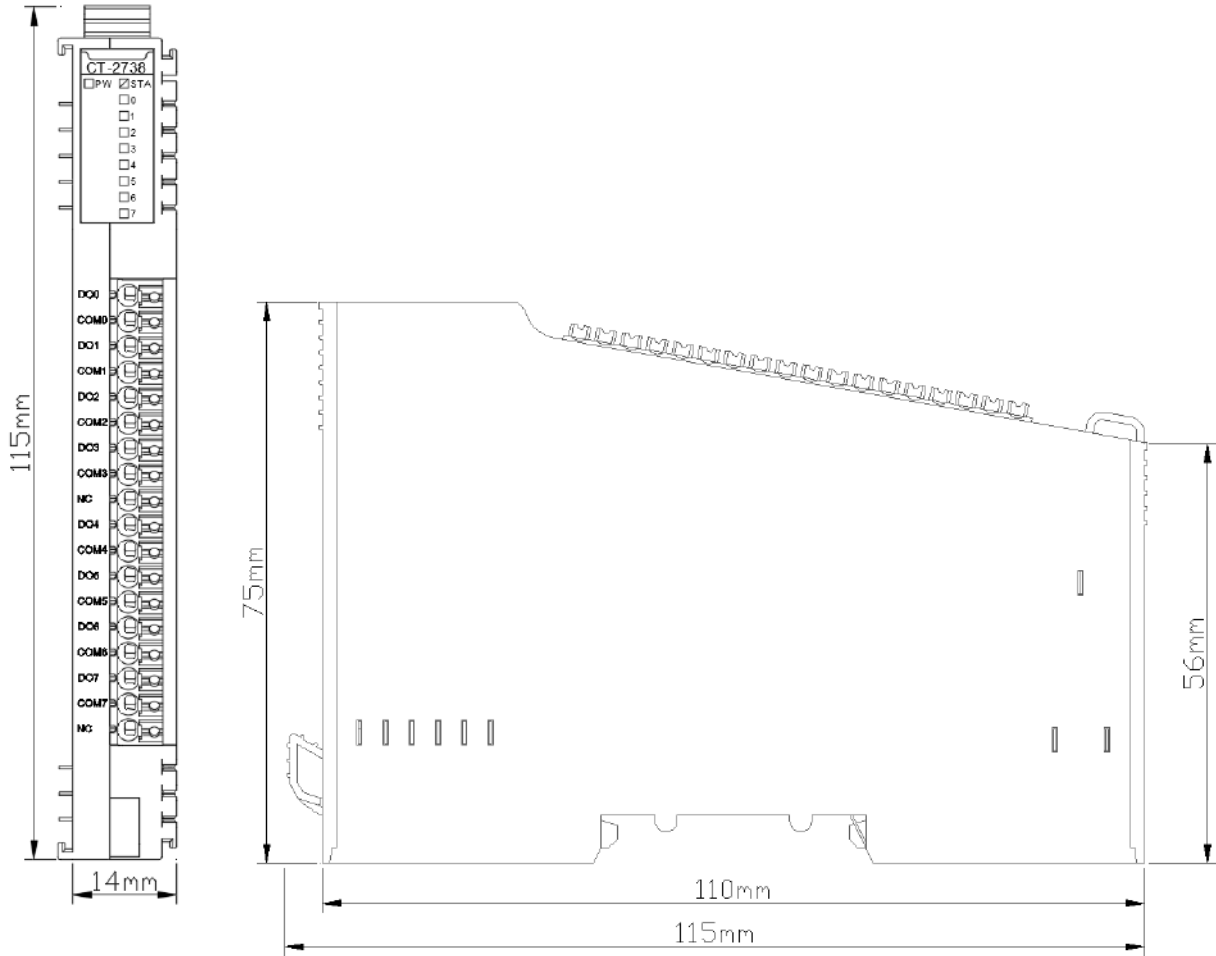

CT-2754 4 channels relay output,3A/30VDC/90W

1 Module features

- ◆ 4-channels relay normally on output
- ◆ 4 LED channel indicators
- ◆ Low on resistance ($\leq 100\text{m}\Omega$)
- ◆ With isolation between channels
- ◆ Built-in unidirectional (freewheel diode) FWD, built-in RC circuit
- ◆ Resistive and inductive loads can be connected

2 Technical Parameters

General Parameters	
Power Consumption	Max.150mA@5.0VDC
Isolation	I/O to internal bus isolation voltage: AC 500V Isolation voltage between channels AC 500V
Field Power	Not used
Wiring	Max.: AWG 18 Min.: AWG 24
Installation	35mm DIN-Rail
Size	115*14*75mm
Weight	65g
Vibration Resistance	Comply with IEC 61131-2 and EC 60068-2-6
Impact resistance	Comply with IEC 61131-2 and IEC 60068-2-27
EMC Performance	Comply with IEC 61131-2 and IEC 61000-4
Environment Specification	
Operating Temperature of Horizontal Installation	-35°C~70°C
Operating Temperature of Vertical Installation	-35°C~60°C
Relative Humidity	< 95%RH (No Condensation)
Storage Temperature	-40°C~85°C
Storage Humidity	< 95%RH (No Condensation)
Manufacturing Test Temperature	-40°C~75°C
Ingress Protection Rating	IP20
Output Parameter	
Channel Number	4 channel Relay normally on output
LED Indicator	4 channel output LED Indicator
Max. Switching Current	Resistive load: 3A Inductive load: 2A
Max. Switching Voltage	30VDC
Max. Switching Power	90W
Switching Frequency	Resistive load: Max 2Hz Inductive load: Max 0.5Hz
Contact Resistance	≤100mΩ
Output Delay	ON to OFF:Max.10ms OFF to ON:Max.10ms
Mechanical Endurance	2x10 ⁷
Electricity Endurance	1x10 ⁵
Vibration	10Hz~55Hz 1.5mm Double vibration amplitude
Impact	Stability: 98m/s ² Strength: 980m/s ²

Load type	General use and Resistive, Pilot Duty
-----------	---------------------------------------

 WARNING

UNEXPECTED EQUIPMENT OPERATION

Do not exceed any of the ratings specified in the environmental and electrical characteristics table.

Failure to follow instructions specified by the manufacturer may result in serious consequences such as death, personal injury, or damage to equipment since the protection provided by the equipment may be impaired.

 AVERTISSEMENT

FONCTIONNEMENT INATTENDU DE L'EQUIPEMENT

Ne dépassez aucune évaluation spécifiée dans le tableau de caractéristiques environnementales et électriques.

Le fait de ne pas suivre les instructions peut entraîner une défaillance de la protection fournie par l'équipement, ce qui peut entraîner des conséquences graves, comme des blessures ou des dommages à l'équipement.

3 Hardware Interface

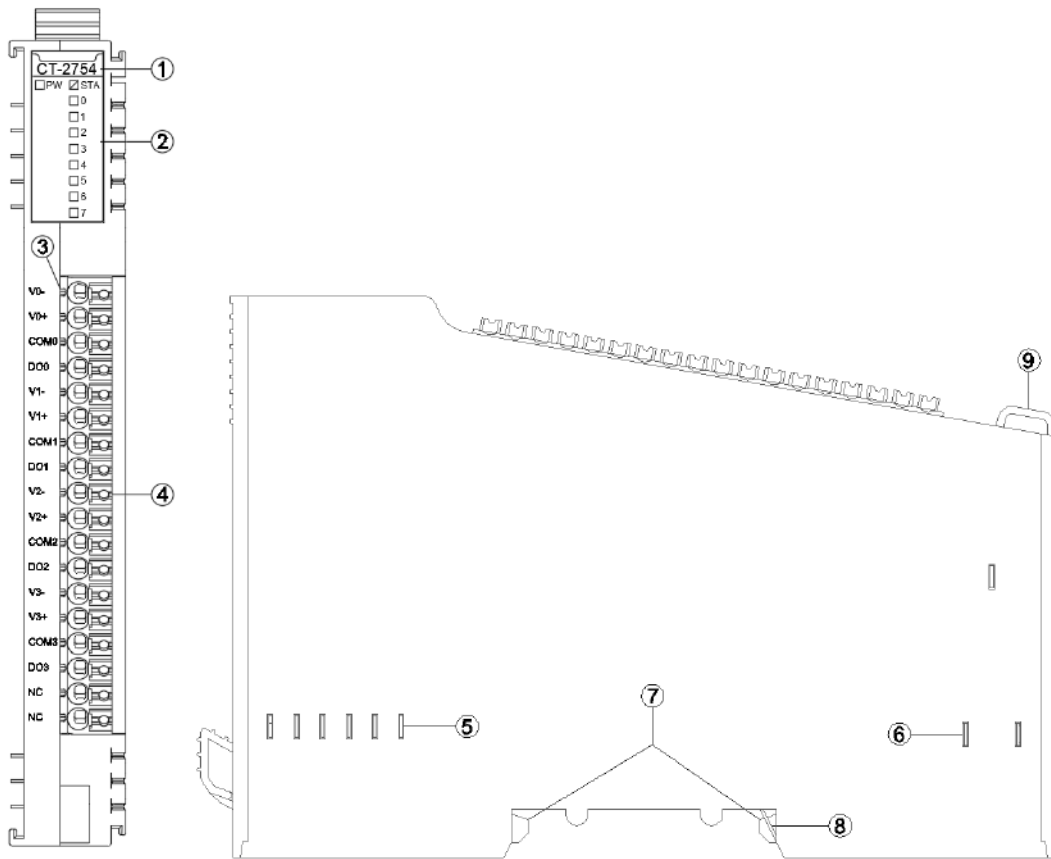

- ① Module Type
- ② State indicator
- ③ N/A
- ④ Wiring Terminal and identification
- ⑤ Internal Bus
- ⑥ Field Power
- ⑦ Buckle
- ⑧ Grounding Spring Sheet
- ⑨ Fixed Wiring Harness

3.1 LED indicator definition

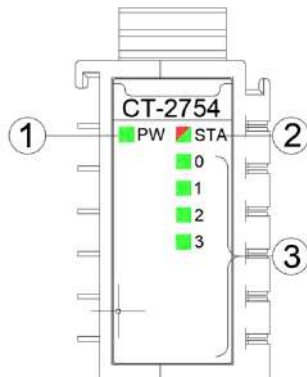

- ① Power LED indicator (green)
- ② Module State LED indicator (red/green)
- ③ Output channel LED indicator (green)

PW Power State (RED)	Definition
ON	Internal bus Power Normal
OFF	Internal bus Power Failure
STA Module State (RED/GREEN)	Definition
Green slow flash (2.5Hz)	Module internal bus is not started
Red slow flash (2.5Hz)	Module internal bus offline
ON (GREEN)	Operation normal
Flash(2.5Hz) (RED/GREEN)	Upgrading mode
Flash(10Hz) (RED/GREEN)	Firmware Update
Double Flash (RED)	Module Exception has been soft-restarted
0-3 channel LED indicator (GREEN)	Definition
ON	Output signal valid
OFF	Output signal invalid

⚠ WARNING

UNEXPECTED EQUIPMENT OPERATION

By viewing the PW indicator, could determine the power supply status of a module. If the PW is steady green, the power supply is normal. Otherwise, the module cannot work properly.

When the module is initially powered on, there will be 3S for the backplane bus connection. After the backplane bus is initialized, STA is in the green steady state. If STA is in the green blinking state, it indicates that the backplane bus has not been initialized, and it needs to be powered off and restarted for re-initialization.

STA abnormal working state occurs during the normal operation of the module, please check the firmware version information of all modules, and consult ODOT technical support for details.

If a module is upgraded, check that all modules are in the normal state after the upgrade. Otherwise, an exception may occur.

Failure to follow instructions specified by the manufacturer may result in serious consequences such as death, personal injury, or damage to equipment since the protection provided by the equipment may be impaired.

 AVERTISSEMENT

FONCTIONNEMENT INATTENDU DE L'EQUIPEMENT

En regardant l'état de l'indicateur de PW, jugez l'état d'alimentation du module. Le feu vert PW reste allumé et l'alimentation est normale. Autrement, le module ne fonctionnera pas correctement.

Lorsque le module est alimenté initialement, il y aura 3S pour la connexion de bus de backboard. STA est un état vert permanent après l'initialisation du bus de backboard. Si STA est en état de clignotement vert, cela signifie que l'initialisation du bus de backboard n'est pas passée et doit être redémarrée hors tension et réinitialisée.

L'état de fonctionnement anormal de STA se produit pendant le fonctionnement normal du module, veuillez vérifier les informations de version du firmware de tous les modules, et consulter le support technique ODOT pour plus de détails.

Si le module a une opération de mise à niveau, après l'achèvement de la mise à niveau, le besoin de vérifier que tous les modules sont dans l'état normal avant de courir, sinon il conduira à une exception.

Le fait de ne pas suivre les instructions peut entraîner une défaillance de la protection fournie par l'équipement, ce qui peut entraîner des conséquences graves, comme des blessures ou des dommages à l'équipement.

3.2 Terminal definition

Terminal Number	Definition	Description
1	V0-	Channel 0 power supply
2	V0+	
3	COM0	Channel 0
4	DO0	
5	V1-	Channel 1 power supply
6	V1+	
7	COM1	Channel 1
8	DO1	
9	V2-	Channel 2 power supply
10	V2+	
11	COM2	Channel 2
12	DO2	
13	V3-	Channel 3 power supply
14	V3+	
15	COM3	Channel 3
16	DO3	
17	NC	Not Connected
18		

Note: Internal V- and COM short circuited for each channel.

WARNING

UNEXPECTED EQUIPMENT OPERATION

Calculate the maximum field power current consumption of a single module based on the actual field load. If the total field power current consumption of all I/O modules exceeds the power supply capacity of the field power supply, you must add an extra power expansion module. Otherwise, an output channel exception may occur.

Failure to follow instructions specified by the manufacturer may result in serious consequences such as death, personal injury, or damage to equipment since the protection provided by the equipment may be impaired.

AVERTISSEMENT

FONCTIONNEMENT INATTENDU DE L'EQUIPEMENT

Calculez la consommation maximale de courant de champ d'un seul module en fonction de la charge de champ réelle. Si la consommation totale de courant de champ de tous les modules d'E/S dépasse la capacité d'alimentation de l'alimentation de champ, vous devez ajouter un module d'extension de puissance supplémentaire. Dans le cas contraire, une exception de canal de sortie peut se produire.

Le fait de ne pas suivre les instructions peut entraîner une défaillance de la protection fournie par l'équipement, ce qui peut entraîner des conséquences graves, comme des blessures ou des dommages à l'équipement.

When connecting a cold-pressed terminal, the terminal must be terminated and checked in strict accordance with the corresponding termination specifications or requirements, and connect the cold-pressed terminal according to the corresponding node serial number. The conductor should use copper conductor and the conductor core should be larger than 0.2mm^2 and smaller than 1mm^2 (AWG18~AWG24). Cold-pressed terminal parameters are as follows:

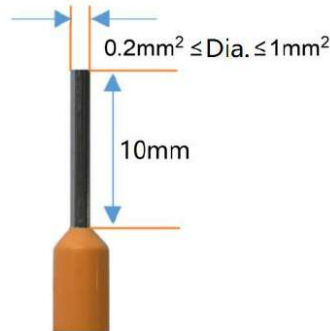

⚠ WARNING

UNEXPECTED EQUIPMENT OPERATION

Strip the length of the conductor insulation layer is greater than 10mm to ensure reliable signal connection.

The wire needs to use copper wire and the wire core is greater than or equal to 0.2mm^2 and less than or equal to 1mm^2 to ensure reliable signal connection.

When connecting a cold-press terminal, connect the cold-press terminal strictly in accordance with the corresponding termination specifications or requirements, and connect the cold-press terminal according to the corresponding node serial number.

Do not power on cold-press terminals until they are properly connected or fully locked.

Failure to follow instructions specified by the manufacturer may result in serious consequences such as death, personal injury, or damage to equipment since the protection provided by the equipment may be impaired.

⚠ AVERTISSEMENT

FONCTIONNEMENT INATTENDU DE L'EQUIPEMENT

Dépouillez la longueur de la couche isolante du fil plus de 10mm pour assurer la connexion fiable du signal.

Le conducteur doit utiliser le fil de cuivre et le noyau de fil est supérieur ou égal à $0,2\text{ mm}^2$, inférieur ou égal à 1mm^2 , afin d'assurer la connexion fiable du signal.

Lorsque les terminaux de presse à froid sont terminés, ils doivent être terminés et visualisés en stricte conformité avec les spécifications ou les exigences correspondantes et terminés selon le numéro de série de noeud correspondant.

Il est interdit d'activer les bornes à froid avant qu'elles ne soient correctement articulées ou complètement verrouillées.

Le fait de ne pas suivre les instructions peut entraîner une défaillance de la protection

fournie par l'équipement, ce qui peut entraîner des conséquences graves, comme des blessures ou des dommages à l'équipement.

DANGER

FIRE DANGER

Use the correct wiring rules only for the maximum current capacity of the I/O channel and power supply.

Failure to follow instructions specified by the manufacturer may result in serious consequences such as death, personal injury, or damage to equipment since the protection provided by the equipment may be impaired.

WARNING

UNEXPECTED EQUIPMENT OPERATION

Do not exceed any of the ratings specified in the environmental and electrical characteristics table.

Failure to follow instructions specified by the manufacturer may result in serious consequences such as death, personal injury, or damage to equipment since the protection provided by the equipment may be impaired.

AVERTISSEMENT

FONCTIONNEMENT INATTENDU DE L'EQUIPEMENT

Ne dépassez aucune évaluation spécifiée dans le tableau de caractéristiques environnementales et électriques..

Le fait de ne pas suivre les instructions peut entraîner une défaillance de la protection fournie par l'équipement, ce qui peut entraîner des conséquences graves, comme des blessures ou des dommages à l'équipement.

4 Wiring

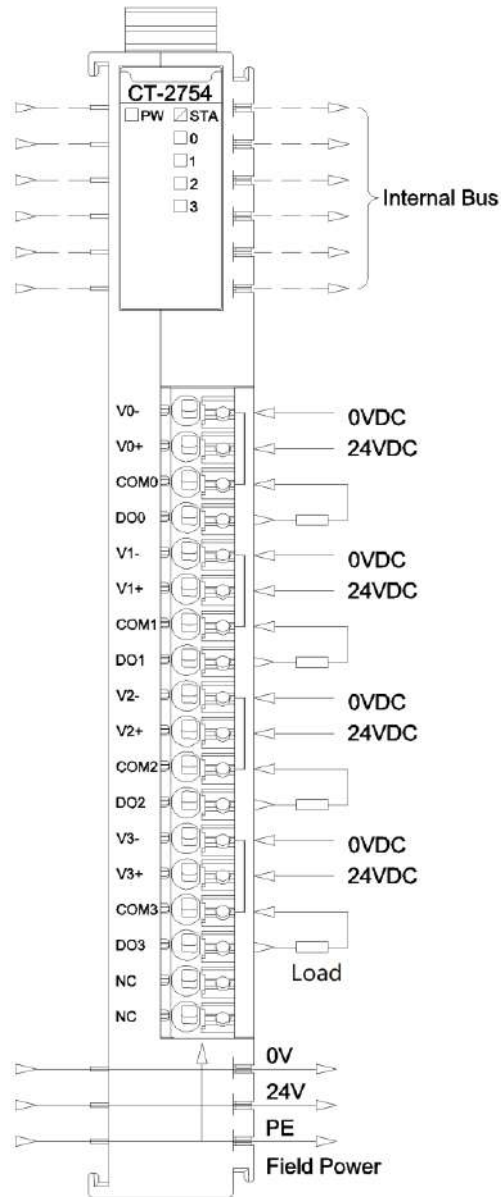

NOTICE

EQUIPMENT INOPERABLE

Do not crimp the spring terminal with more than the maximum pressure specified for the terminal. Otherwise, the resilience of the spring terminal may be damaged and the terminal rebound may be affected.

Do not press the spring terminal with a sharp tool when removing cable from the channel. Otherwise, the spring terminal will be damaged.

Failure to follow these instructions may result in equipment damage.

5 Process data definition

Output Data								
Bit No	Bit 7	Bit 6	Bit 5	Bit 4	Bit 3	Bit 2	Bit 1	Bit 0
Byte 0	Reserved				DO Ch#3	DO Ch#2	DO Ch#1	DO Ch#0

Data description:

DO Ch#(0-3): When the bit is 1, the output signal of corresponding channel is effective and the relay output contact is closed. When the bit is 0, the output is invalid and the relay contact is disconnected.

0: The output signal is invalid

1: The output signal is valid

6 Configuration parameters definition

Configuration parameters								
Bit No	Bit 7	Bit 6	Bit 5	Bit 4	Bit 3	Bit 2	Bit 1	Bit 0
Byte 0	Reserved				Fault Action for Output Ch#3	Fault Action for Output Ch#2	Fault Action for Output Ch#1	Fault Action for Output Ch#0
Byte 1	Reserved				Fault Value for Output Ch#3	Fault Value for Output Ch#2	Fault Value for Output Ch#1	Fault Value for Output Ch#0

Data description:

Fault Action for Output Ch#(0-3): Fault output mode. When IO module detects that internal bus communication is failed and enters offline mode, the output data will be processed in this mode. (Default: 0)

0: Hold the last output state.

1: Output fault value

Fault Value for Output Ch#(0-3): When the fault output mode is 1, this bit would set the fault output value, and when the internal bus of IO module is offline, this setting value will be output. (Default: 0)

0: Output low level.

1: Output high level.

A Dimension drawing

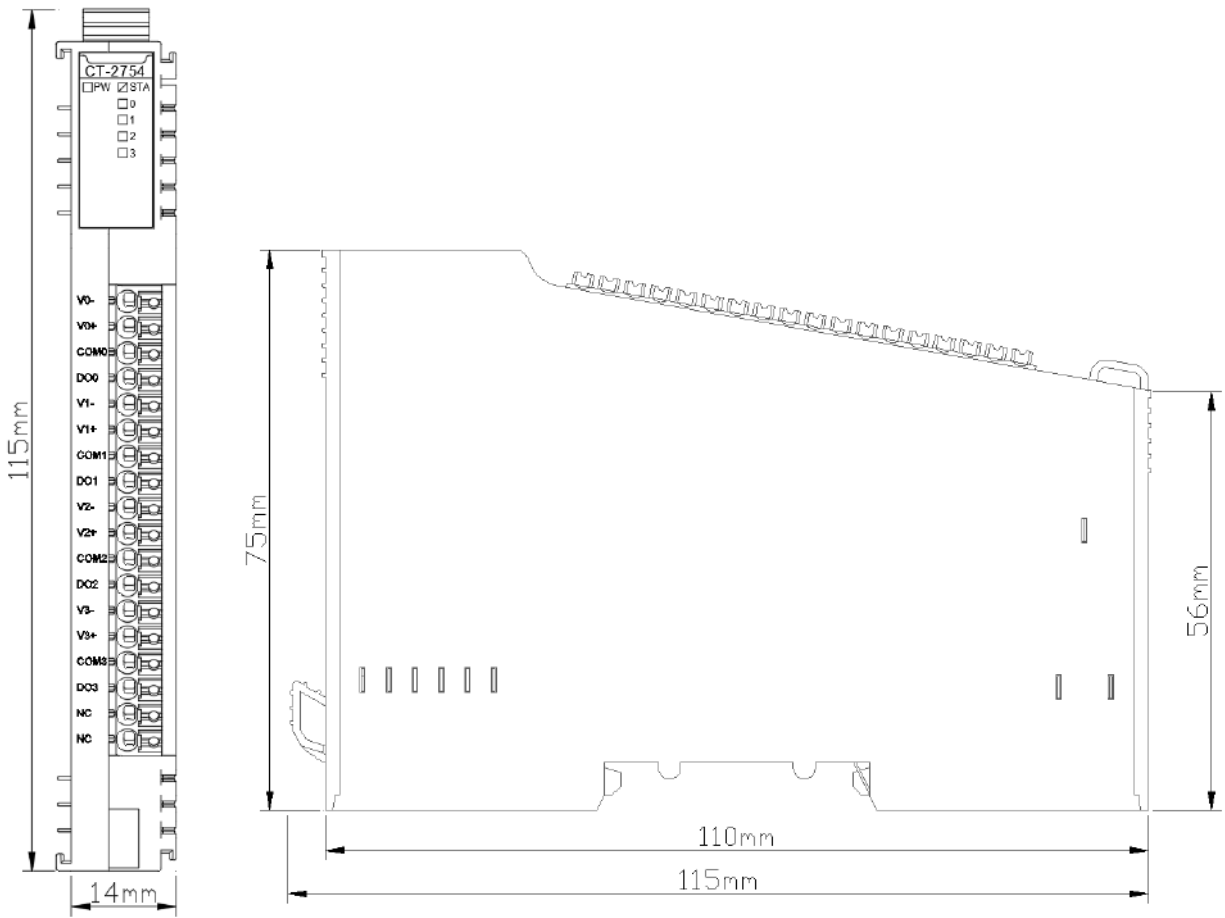

CT-2794 4 channel relay output,2A/250VAC/500VA

1 Module features

- ◆ 4-channels relay normally on output
- ◆ 4 LED channel indicators
- ◆ Low on resistance ($\leq 100\text{m}\Omega$)
- ◆ With isolation between channels
- ◆ Resistive and inductive loads can be connected

2 Technical Parameters

General Parameters	
Power Consumption	Max. 160mA @ 5.0VDC
Isolation	I/O to internal bus isolation voltage AC 3kV The isolation voltage between the channels is AC 600V
On-site Power Supply	Unused
Connection	Max.: AWG 18 Min.: AWG 24
Installation:	35mm DIN-Rail
Size	115*14*75mm
Weight	70g
Environmental parameters	
Operating Temperature of Horizontal Installation	-35°C~70°C
Operating Temperature of Vertical Installation	-35°C~60°C
Relative Humidity	< 95%RH non-condensing
Storage Temperature	-40°C~85°C
Storage Humidity	< 95%RH non-condensing
Manufacturing Test Temperature	-40°C~75°C
Ingress Protection Rating	IP20
Output Parameters	
Number of Channels	4-channel relay normally open output
LED Indicator	4 channel output indicators
Maximum Switching Current	Resistive: 2A Sensibility: 1A
Maximum Switching Voltage	250VAC
Maximum Switching Power	500VA
Switching Frequency	Resistance: Max 2Hz Inductive: Max 0.5Hz
Contact Resistance	≤100mΩ
Output Delay	ON to OFF:Max.10ms OFF to ON:Max.5ms
Mechanical Durability	2x10 ⁷ times
Electrical Durability	5x10 ⁴ times
Vibration	10Hz~55Hz 1.5mm double amplitude
Impact	Stability: 98m/s ² Intensity: 980m/s ²
Load type	General use and Resistive, Pilot Duty

 **WARNING**

UNEXPECTED EQUIPMENT OPERATION

Do not exceed any of the ratings specified in the environmental and electrical characteristics table.

Failure to follow instructions specified by the manufacturer may result in serious consequences such as death, personal injury, or damage to equipment since the protection provided by the equipment may be impaired.

 **AVERTISSEMENT**

FONCTIONNEMENT INATTENDU DE L'EQUIPEMENT

Ne dépassez aucune évaluation spécifiée dans le tableau de caractéristiques environnementales et électriques.

Le fait de ne pas suivre les instructions peut entraîner une défaillance de la protection fournie par l'équipement, ce qui peut entraîner des conséquences graves, comme des blessures ou des dommages à l'équipement.

3 Hardware Interface

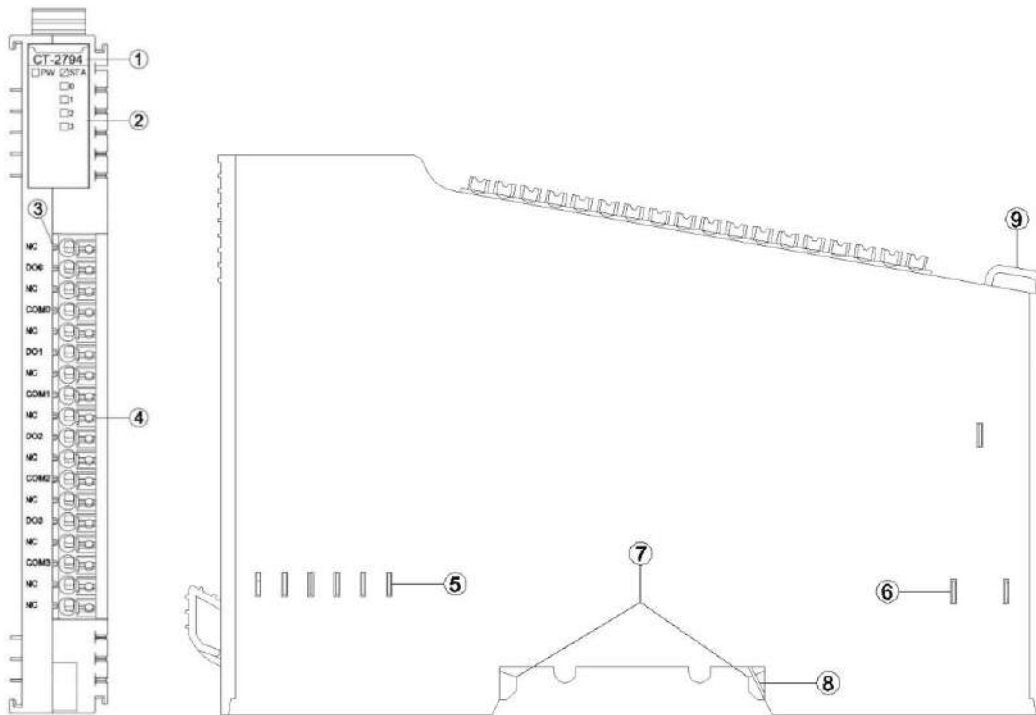

- ① Module Type
- ② State indicator
- ③ N/A
- ④ Wiring Terminal and identification
- ⑤ Internal Bus
- ⑥ Field Power
- ⑦ Buckle
- ⑧ Grounding Spring Sheet
- ⑨ Fixed Wiring Harness

3.1 LED indicator definition

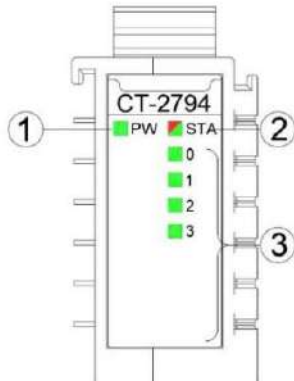

- ① Power LED indicator (green)
- ② Module State LED indicator (red/green)
- ③ Output channel LED indicator (green)

PW Power State (GREEN)	Definition
ON	Internal bus Power Normal
OFF	Internal bus Power Failure
STA Module State (RED/GREEN)	Definition
Green slow flash (2.5Hz)	Module internal bus is not started
Red slow flash (2.5Hz)	Module internal bus offline
ON (GREEN)	Operation normal
Flash(2.5Hz) (RED/GREEN)	Upgrading mode
Flash(10Hz) (RED/GREEN)	Firmware Upgrading
Double Flash (RED)	Module Exception has been soft-restarted
0-3 Channel LED Indicator (GREEN)	Definition
ON	Output signal valid
OFF	Output signal invalid

⚠ WARNING

UNEXPECTED EQUIPMENT OPERATION

By viewing the PW indicator, could determine the power supply status of a module. If the PW is steady green, the power supply is normal. Otherwise, the module cannot work properly.

When the module is initially powered on, there will be 3S for the backplane bus connection. After the backplane bus is initialized, STA is in the green steady state. If STA is in the green blinking state, it indicates that the backplane bus has not been initialized, and it needs to be powered off and restarted for re-initialization.

STA abnormal working state occurs during the normal operation of the module, please check the firmware version information of all modules, and consult ODOT technical support for details.

If a module is upgraded, check that all modules are in the normal state after the upgrade. Otherwise, an exception may occur.

Failure to follow instructions specified by the manufacturer may result in serious consequences such as death, personal injury, or damage to equipment since the protection provided by the equipment may be impaired.

 AVERTISSEMENT

FONCTIONNEMENT INATTENDU DE L'EQUIPEMENT

En regardant l'état de l'indicateur de PW, jugez l'état d'alimentation du module. Le feu vert PW reste allumé et l'alimentation est normale. Autrement, le module ne fonctionnera pas correctement.

Lorsque le module est alimenté initialement, il y aura 3S pour la connexion de bus de backboard. STA est un état vert permanent après l'initialisation du bus de backboard. Si STA est en état de clignotement vert, cela signifie que l'initialisation du bus de backboard n'est pas passée et doit être redémarrée hors tension et réinitialisée.

L'état de fonctionnement anormal de STA se produit pendant le fonctionnement normal du module, veuillez vérifier les informations de version du firmware de tous les modules, et consulter le support technique ODOT pour plus de détails.

Si le module a une opération de mise à niveau, après l'achèvement de la mise à niveau, le besoin de vérifier que tous les modules sont dans l'état normal avant de courir, sinon il conduira à une exception.

Le fait de ne pas suivre les instructions peut entraîner une défaillance de la protection fournie par l'équipement, ce qui peut entraîner des conséquences graves, comme des blessures ou des dommages à l'équipement.

3.2 Terminal definition

Terminal serial number	Definition	Illustrate
1	NC	Not connected
2	DO0	Channel 0 with output
3	NC	Not connected
4	COM0	Channel 0 COM port
5	NC	Not connected
6	DO1	Channel 1 output
7	NC	Not connected
8	COM1	Channel 1 COM port
9	NC	Not connected
10	DO2	Channel 2 output
11	NC	Not connected
12	COM2	Channel 2 COM port
13	NC	Not connected
14	DO3	Channel 3 output
15	NC	Not connected
16	COM3	Channel 3 COM port
17	NC	Not connected
18		

WARNING

UNEXPECTED EQUIPMENT OPERATION

Calculate the maximum field power current consumption of a single module based on the actual field load. If the total field power current consumption of all I/O modules exceeds the power supply capacity of the field power supply, you must add an extra power expansion module. Otherwise, an output channel exception may occur.

Failure to follow instructions specified by the manufacturer may result in serious consequences such as death, personal injury, or damage to equipment since the protection provided by the equipment may be impaired.

AVERTISSEMENT

FONCTIONNEMENT INATTENDU DE L'EQUIPEMENT

Calculez la consommation maximale de courant de champ d'un seul module en fonction de la charge de champ réelle. Si la consommation totale de courant de champ de tous les modules d'E/S dépasse la capacité d'alimentation de l'alimentation de champ, vous devez ajouter un module d'extension de puissance supplémentaire. Dans le cas contraire, une exception de canal de sortie peut se produire.

Le fait de ne pas suivre les instructions peut entraîner une défaillance de la protection fournie par l'équipement, ce qui peut entraîner des conséquences graves, comme des blessures ou des dommages à l'équipement.

When connecting a cold-pressed terminal, the terminal must be terminated and checked in strict accordance with the corresponding termination specifications or requirements, and connect the cold-pressed terminal according to the corresponding node serial number. The conductor should use copper conductor and the conductor core should be larger than 0.2mm^2 and smaller than 1mm^2 (AWG18~AWG24). Cold-pressed terminal parameters are as follows:

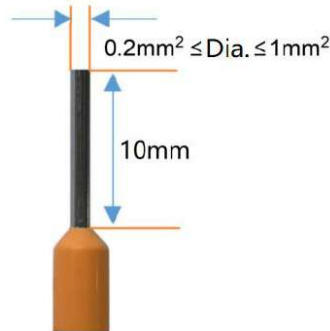

⚠ WARNING

UNEXPECTED EQUIPMENT OPERATION

Strip the length of the conductor insulation layer is greater than 10mm to ensure reliable signal connection.

The wire needs to use copper wire and the wire core is greater than or equal to 0.2mm^2 and less than or equal to 1mm^2 to ensure reliable signal connection.

When connecting a cold-press terminal, connect the cold-press terminal strictly in accordance with the corresponding termination specifications or requirements, and connect the cold-press terminal according to the corresponding node serial number.

Do not power on cold-press terminals until they are properly connected or fully locked.

Failure to follow instructions specified by the manufacturer may result in serious consequences such as death, personal injury, or damage to equipment since the protection provided by the equipment may be impaired.

⚠ AVERTISSEMENT

FONCTIONNEMENT INATTENDU DE L'EQUIPEMENT

Dépouillez la longueur de la couche isolante du fil plus de 10mm pour assurer la connexion fiable du signal.

Le conducteur doit utiliser le fil de cuivre et le noyau de fil est supérieur ou égal à $0,2\text{ mm}^2$, inférieur ou égal à 1mm^2 , afin d'assurer la connexion fiable du signal.

Lorsque les terminaux de presse à froid sont terminés, ils doivent être terminés et visualisés en stricte conformité avec les spécifications ou les exigences correspondantes et terminés selon le numéro de série de noeud correspondant.

Il est interdit d'activer les bornes à froid avant qu'elles ne soient correctement articulées ou complètement verrouillées.

Le fait de ne pas suivre les instructions peut entraîner une défaillance de la protection

fournie par l'équipement, ce qui peut entraîner des conséquences graves, comme des blessures ou des dommages à l'équipement.

DANGER

FIRE DANGER

Use the correct wiring rules only for the maximum current capacity of the I/O channel and power supply.

Failure to follow instructions specified by the manufacturer may result in serious consequences such as death, personal injury, or damage to equipment since the protection provided by the equipment may be impaired.

WARNING

UNEXPECTED EQUIPMENT OPERATION

Do not exceed any of the ratings specified in the environmental and electrical characteristics table.

Failure to follow instructions specified by the manufacturer may result in serious consequences such as death, personal injury, or damage to equipment since the protection provided by the equipment may be impaired.

AVERTISSEMENT

FONCTIONNEMENT INATTENDU DE L'EQUIPEMENT

Ne dépassez aucune évaluation spécifiée dans le tableau de caractéristiques environnementales et électriques..

Le fait de ne pas suivre les instructions peut entraîner une défaillance de la protection fournie par l'équipement, ce qui peut entraîner des conséquences graves, comme des blessures ou des dommages à l'équipement.

4 Wiring

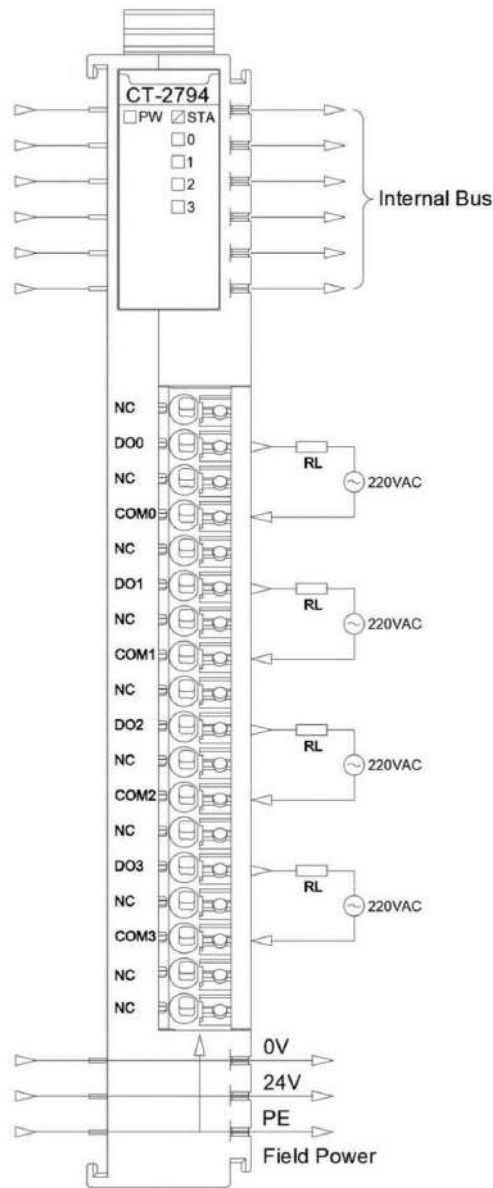

NOTICE

EQUIPMENT INOPERABLE

Do not crimp the spring terminal with more than the maximum pressure specified for the terminal. Otherwise, the resilience of the spring terminal may be damaged and the terminal rebound may be affected.

Do not press the spring terminal with a sharp tool when removing cable from the channel. Otherwise, the spring terminal will be damaged.

Failure to follow these instructions may result in equipment damage.

5 Process data definition

Output Data								
Bit No	Bit 7	Bit 6	Bit 5	Bit 4	Bit 3	Bit 2	Bit 1	Bit 0
Byte 0	Reserved				DO Ch#3	DO Ch#2	DO Ch#1	DO Ch#0

Data description:

DO Ch#(0-3): When the bit is 1, the output signal of corresponding channel is effective and the relay output contact is closed. When the bit is 0, the output is invalid and the relay contact is disconnected.

0: The output signal is invalid

1: The output signal is valid

6 Configuration parameters definition

Configuration parameters								
Bit No	Bit 7	Bit 6	Bit 5	Bit 4	Bit 3	Bit 2	Bit 1	Bit 0
Byte 0	Reserved				Fault Action for Output Ch#3	Fault Action for Output Ch#2	Fault Action for Output Ch#1	Fault Action for Output Ch#0
Byte 1	Reserved				Fault Value for Output Ch#3	Fault Value for Output Ch#2	Fault Value for Output Ch#1	Fault Value for Output Ch#0

Data description:

Fault Action for Output Ch#(0-3): Fault output mode. When IO module detects that internal bus communication is failed and enters offline mode, the output data will be processed in this mode. (Default: 0)

0: Hold the last output state.

1: Output fault value

Fault Value for Output Ch#(0-3): When the fault output mode is 1, this bit would set the fault output value, and when the internal bus of IO module is offline, this setting value will be output. (Default: 0)

0: Output low level.

1: Output high level.

A Dimension drawing

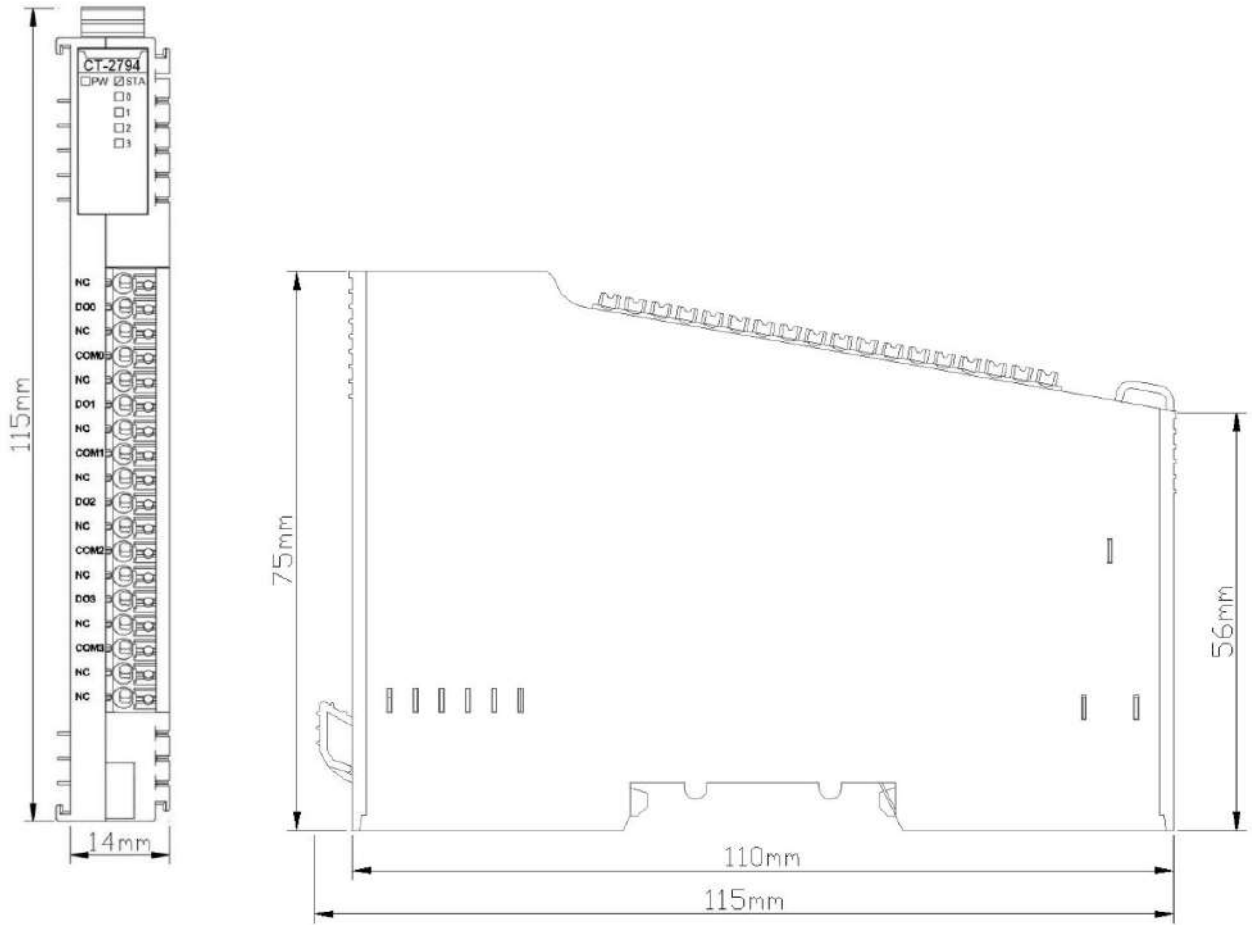

CT-3134 4 channels Voltage Input

0~5/0~10/±5/±10VDC,15 bits /16 bits

1 Module features

- ◆ The module supports 4 channels of voltage signal input
- ◆ The module can collect 0~5VDC, 0~10VDC, ±5VDC, ±10VDC, with 15 bits and 16 bits resolution
- ◆ The module carries with 4 analog input channel LED indicator
- ◆ Filtering time can be set
- ◆ Channels can be disabled independently
- ◆ With isolation between channels

2 Technical Parameters

General Parameters	
Power	Max.260mA@5.0VDC
Isolation	I/O to internal bus isolation voltage AC 500V The isolation voltage between channels is AC 500V
Field Power	Not used
Wiring	Max.: AWG 18 Min.: AWG 24
Installation	35mmDIN-Rail
Size	115*14*75mm
Weight	65g
Vibration Resistance	Comply with IEC 61131-2 and EC 60068-2-6
Impact resistance	Comply with IEC 61131-2 and IEC 60068-2-27
EMC Performance	Comply with IEC 61131-2 and IEC 61000-4
Environment Specification	
Operating Temperature of Horizontal Installation	-35°C~70°C
Operating Temperature of Vertical Installation	-35°C~60°C
Relative Humidity	< 95%RH (No Condensation)
Storage Temperature	-40°C~85°C
Storage Humidity	< 95%RH (No Condensation)
Manufacturing Test Temperature	-40°C~75°C
Ingress Protection Rating	IP20
Input Parameter	
Channel Number	4 channel voltage input
LED Indicator	4 channel input indicators
Input Voltage Range	0~5VDC, 0~10VDC, ±5VDC and ±10VDC
Resolution	16 bits
Accuracy	±0.3%@25°C ±0.5% @ -40~55°C
Sampling Rate	12ms/4 channel
Output Impedance	100KΩ (±5%)
Channel Disable	supported
Diagnostic Function	Channel disabled fault value: -32767 Overflow: 32767 (Overflow failure value supported only in standard mode) Underflow: -32768(Underflow fault value supported only in standard mode)

 **WARNING**

UNEXPECTED EQUIPMENT OPERATION

Do not exceed any of the ratings specified in the environmental and electrical characteristics table.

Failure to follow instructions specified by the manufacturer may result in serious consequences such as death, personal injury, or damage to equipment since the protection provided by the equipment may be impaired.

 **AVERTISSEMENT**

FONCTIONNEMENT INATTENDU DE L'EQUIPEMENT

Ne dépassez aucune évaluation spécifiée dans le tableau de caractéristiques environnementales et électriques.

Le fait de ne pas suivre les instructions peut entraîner une défaillance de la protection fournie par l'équipement, ce qui peut entraîner des conséquences graves, comme des blessures ou des dommages à l'équipement.

3 Hardware Interface

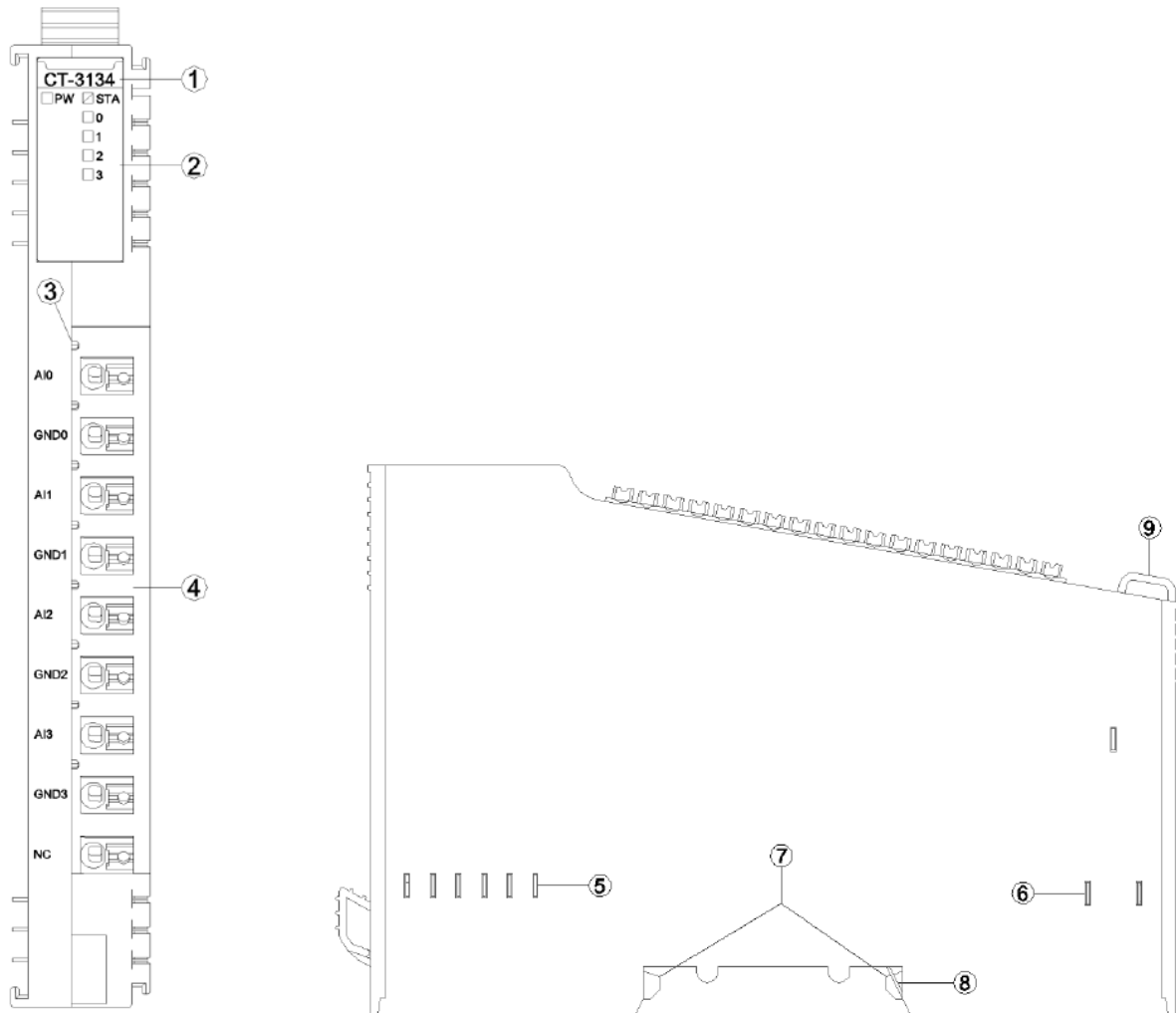

- ① Module Type
- ② State indicator
- ③ N/A
- ④ Wiring Terminal and identification
- ⑤ Internal Bus
- ⑥ Field Power
- ⑦ Buckle
- ⑧ Grounding Spring Sheet
- ⑨ Fixed Wiring Harness

3.1 LED indicator definition

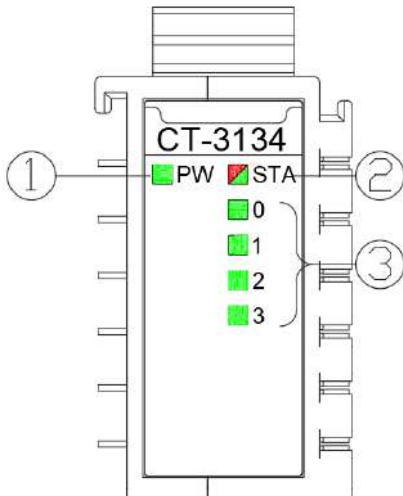

- ① Power LED indicator (green)
- ② Module State LED indicator (red/green)
- ③ Input channel LED indicator (green)

PW POWER STATE (GREEN)	Definition
ON	Internal bus Power Normal
OFF	Internal bus Power Failure
STA MODULE STATE (RED/GREEN)	Definition
Green slow flash (2.5Hz)	Module internal bus is not started
Red slow flash (2.5Hz)	Module internal bus is offline
ON (GREEN)	Operation normal
Flash(2.5Hz) (RED/GREEN)	Upgrading mode
Flash(10Hz) (RED/GREEN)	Firmware Update
Double Flash (RED)	Module Exception, has been soft-restarted
0-3 channel LED indicator (GREEN)	Definition
ON	The input signal exceeds 0.15V or - 0.15V
OFF	Input signal invalid

⚠ WARNING

UNEXPECTED EQUIPMENT OPERATION

By viewing the PW indicator, could determine the power supply status of a module. If the PW is steady green, the power supply is normal. Otherwise, the module cannot work properly.

When the module is initially powered on, there will be 3S for the backplane bus connection. After

the backplane bus is initialized, STA is in the green steady state. If STA is in the green blinking state, it indicates that the backplane bus has not been initialized, and it needs to be powered off and restarted for re-initialization.

STA abnormal working state occurs during the normal operation of the module, please check the firmware version information of all modules, and consult ODOT technical support for details.

If a module is upgraded, check that all modules are in the normal state after the upgrade. Otherwise, an exception may occur.

Failure to follow instructions specified by the manufacturer may result in serious consequences such as death, personal injury, or damage to equipment since the protection provided by the equipment may be impaired.

AVERTISSEMENT

FONCTIONNEMENT INATTENDU DE L'EQUIPEMENT

En regardant l'état de l'indicateur de PW, jugez l'état d'alimentation du module. Le feu vert PW reste allumé et l'alimentation est normale. Autrement, le module ne fonctionnera pas correctement.

Lorsque le module est alimenté initialement, il y aura 3S pour la connexion de bus de backboard. STA est un état vert permanent après l'initialisation du bus de backboard. Si STA est en état de clignotement vert, cela signifie que l'initialisation du bus de backboard n'est pas passée et doit être redémarrée hors tension et réinitialisée.

L'état de fonctionnement anormal de STA se produit pendant le fonctionnement normal du module, veuillez vérifier les informations de version du firmware de tous les modules, et consulter le support technique ODOT pour plus de détails.

Si le module a une opération de mise à niveau, après l'achèvement de la mise à niveau, le besoin de vérifier que tous les modules sont dans l'état normal avant de courir, sinon il conduira à une exception.

Le fait de ne pas suivre les instructions peut entraîner une défaillance de la protection fournie par l'équipement, ce qui peut entraîner des conséquences graves, comme des blessures ou des dommages à l'équipement.

3.2 Terminal definition

Terminal Number	Definition	Definition
1	AI0	Signal Input CH0
2	GND0	Common port CH0
3	AI1	Signal Input CH1
4	GND1	Common port CH1
5	AI2	Signal Input CH2
6	GND2	Common port CH2
7	AI3	Signal Input CH3
8	GND3	Common port CH3
9	NC	Not Connected

WARNING

UNEXPECTED EQUIPMENT OPERATION

Calculate the maximum field power current consumption of a single module based on the actual field load. If the total field power current consumption of all I/O modules exceeds the power supply capacity of the field power supply, you must add an extra power expansion module. Otherwise, an output channel exception may occur.

Failure to follow instructions specified by the manufacturer may result in serious consequences such as death, personal injury, or damage to equipment since the protection provided by the equipment may be impaired.

AVERTISSEMENT

FONCTIONNEMENT INATTENDU DE L'EQUIPEMENT

Calculez la consommation maximale de courant de champ d'un seul module en fonction de la charge de champ réelle. Si la consommation totale de courant de champ de tous les modules d'E/S dépasse la capacité d'alimentation de l'alimentation de champ, vous devez ajouter un module d'extension de puissance supplémentaire. Dans le cas contraire, une exception de canal de sortie peut se produire.

Le fait de ne pas suivre les instructions peut entraîner une défaillance de la protection fournie par l'équipement, ce qui peut entraîner des conséquences graves, comme des blessures ou des dommages à l'équipement.

When connecting a cold-pressed terminal, the terminal must be terminated and checked in strict accordance with the corresponding termination specifications or requirements, and connect the cold-pressed terminal according to the corresponding node serial number. The conductor should use copper conductor and the conductor core should be larger than 0.2mm² and smaller than 1mm² (AWG18~AWG24). Cold-

pressed terminal parameters are as follows:

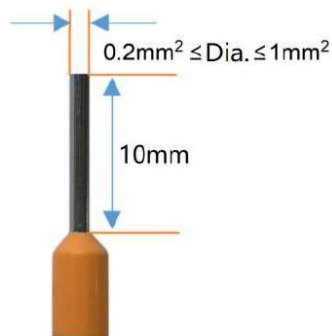

⚠ WARNING

UNEXPECTED EQUIPMENT OPERATION

Strip the length of the conductor insulation layer is greater than 10mm to ensure reliable signal connection.

The wire needs to use copper wire and the wire core is greater than or equal to 0.2mm^2 and less than or equal to 1mm^2 to ensure reliable signal connection.

When connecting a cold-press terminal, connect the cold-press terminal strictly in accordance with the corresponding termination specifications or requirements, and connect the cold-press terminal according to the corresponding node serial number.

Do not power on cold-press terminals until they are properly connected or fully locked.

Failure to follow instructions specified by the manufacturer may result in serious consequences such as death, personal injury, or damage to equipment since the protection provided by the equipment may be impaired.

⚠ AVERTISSEMENT

FONCTIONNEMENT INATTENDU DE L'EQUIPEMENT

Dépouillez la longueur de la couche isolante du fil plus de 10mm pour assurer la connexion fiable du signal.

Le conducteur doit utiliser le fil de cuivre et le noyau de fil est supérieur ou égal à $0,2\text{ mm}^2$, inférieur ou égal à 1mm^2 , afin d'assurer la connexion fiable du signal.

Lorsque les terminaux de presse à froid sont terminés, ils doivent être terminés et visualisés en stricte conformité avec les spécifications ou les exigences correspondantes et terminés selon le numéro de série de noeud correspondant.

Il est interdit d'activer les bornes à froid avant qu'elles ne soient correctement articulées ou complètement verrouillées.

Le fait de ne pas suivre les instructions peut entraîner une défaillance de la protection fournie par l'équipement, ce qui peut entraîner des conséquences graves, comme des blessures ou des dommages à l'équipement.

DANGER

FIRE DANGER

Use the correct wiring rules only for the maximum current capacity of the I/O channel and power supply.

Failure to follow instructions specified by the manufacturer may result in serious consequences such as death, personal injury, or damage to equipment since the protection provided by the equipment may be impaired.

WARNING

UNEXPECTED EQUIPMENT OPERATION

Do not exceed any of the ratings specified in the environmental and electrical characteristics table.

Failure to follow instructions specified by the manufacturer may result in serious consequences such as death, personal injury, or damage to equipment since the protection provided by the equipment may be impaired.

AVERTISSEMENT

FONCTIONNEMENT INATTENDU DE L'EQUIPEMENT

Ne dépassez aucune évaluation spécifiée dans le tableau de caractéristiques environnementales et électriques..

Le fait de ne pas suivre les instructions peut entraîner une défaillance de la protection fournie par l'équipement, ce qui peut entraîner des conséquences graves, comme des blessures ou des dommages à l'équipement.

4 Wiring

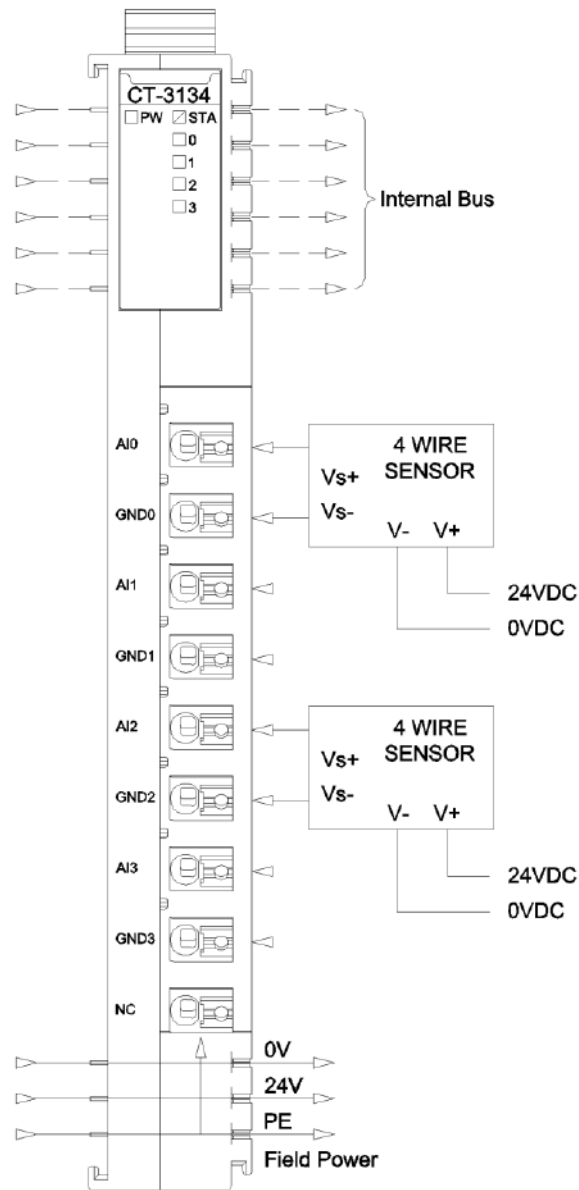

NOTICE

EQUIPMENT INOPERABLE

Do not crimp the spring terminal with more than the maximum pressure specified for the terminal. Otherwise, the resilience of the spring terminal may be damaged and the terminal rebound may be affected.

Do not press the spring terminal with a sharp tool when removing cable from the channel. Otherwise, the spring terminal will be damaged.

Failure to follow these instructions may result in equipment damage.

 **WARNING**

UNEXPECTED EQUIPMENT OPERATION

Do not link wires to unused terminals and/or terminals marked "NO CONNECTION (NC)"
Failure to follow instructions specified by the manufacturer may result in serious consequences such as death, personal injury, or damage to equipment since the protection provided by the equipment may be impaired.

 **AVERTISSEMENT**

FONCTIONNEMENT INATTENDU DE L'EQUIPEMENT

Ne reliez pas les fils aux terminaux inutilisés et/ou aux terminaux marqués «NO CONNECTION (NC)»

Le fait de ne pas suivre les instructions peut entraîner une défaillance de la protection fournie par l'équipement, ce qui peut entraîner des conséquences graves, comme des blessures ou des dommages à l'équipement.

5 Process data definition

Input Data								
Bit No	Bit 7	Bit 6	Bit 5	Bit 4	Bit 3	Bit 2	Bit 1	Bit 0
Byte 0	Analog Input Data (CH 0)							
Byte 1								
Byte 2	Analog Input Data (CH 1)							
Byte 3								
Byte 4	Analog Input Data (CH 2)							
Byte 5								
Byte 6	Analog Input Data (CH 3)							
Byte 7								
Byte 15								

5.1 Process data definition (Standard mode)

Data description:

Analog Input Data (CH0-7): Voltage input data value

Process data definition(8AI)						
Voltage (0-5V)	Voltage (0-10V)	Voltage ($\pm 5V$)	Voltage ($\pm 10V$)	Decimal	HEX	
>5.06	>10.12	>5.06	>10.12	32767	0x7FFF	Overflow
5.06	10.12	5.06	10.12	27979	0x6D4B	Exceeds the upper limit
5V+0.1808mv	10V+0.3617mv	5V+0.1808mv	10V+0.3617mv	27649	0x6C01	
5	10	5	10	27648	0x6C00	Rated range
.	
.	
2.5	5	2.5	5	13824	0x3600	
.	
.	
0	0	0	0	0	0x0000	
/	/	
/	/	
/	/	-2.5	-5	-13824	0XCA00	
/	/	
/	/	
/	/	-5	-10	-27648	0x9400	
/	/	-5V-0.1808mv	-10V-0.3617mv	-27649	0x93FF	Exceeds the lower limit
/	/	-5.06	-10.12	-27979	0x92B5	
/	/	-5.06<	-10.12<	-32768	0x8000	Underflow

5.2 Process data definition (special mode)

Process data definition (4AI)					
Voltage (0-5V)	Voltage (0-10V)	Voltage ($\pm 5V$)	Voltage ($\pm 10V$)	Decimal	HEX
5	10	5	10	32767	0x7FFF
.
.
2.5	5	2.5	5	16383	0x3FFF
.
.
0	0	0	0	0	0x0000
/	/
/	/
/	/	-2.5	-5	-16384	0xC000
/	/
/	/
/	/	-5	-10	-32768	0x8000

6 Configuration parameters definition

Configuration Parameters								
Bit No	Bit 7	Bit 6	Bit 5	Bit 4	Bit 3	Bit 2	Bit 1	Bit 0
Byte 0	Reserved						Range_Mode	16Bit Data Format
Byte 1	Voltage Type (CH 1)				Voltage Type (CH 0)			
Byte 2	Voltage Type (CH 3)				Voltage Type (CH 2)			
Byte 3	Reserved							
Byte 4								
Byte 5	Filtering Time (CH0)							
Byte 6								
Byte 7	Filtering Time (CH1)							
Byte 8								
Byte 9	Filtering Time (CH2)							
Byte 10								
Byte 11	Filtering Time (CH3)							
Byte 12								
Byte 13 ... Byte 29	Reserved							

Data description:

16Bit Data Format: Sequence of 16-bit data byte transmission (Default:0)

0: A_B

1: B_A

Range_Mode: Process data mode (default: standard mode)

Standard mode: same with SIEMENS process data definition

Special mode: max range of the hardware.

Voltage Type(CH 0-3): Input voltage type (Default:3)

0: disabled

1: 0~5VDC



2: -5~5VDC

3: 0~10VDC

4: -10~10VDC

Filtering Time(CH0-CH3): The input filtering time of the channel, unit in “ms”.

(Default: 10)

 WARNING
<p>UNEXPECTED EQUIPMENT OPERATION</p> <p>The filtering parameters could be adjusted according to the field conditions. If the parameter settings are inappropriate, the signal will be lost.</p> <p>Input voltage type parameters can be adjusted according to the site conditions. If the parameter Settings are inappropriate, signal loss will occur.</p> <p>Failure to follow instructions specified by the manufacturer may result in serious consequences such as death, personal injury, or damage to equipment since the protection provided by the equipment may be impaired.</p>
 AVERTISSEMENT
<p>FONCTIONNEMENT INATTENDU DE L'EQUIPEMENT</p> <p>Les paramètres de filtrage peuvent être ajustés en fonction des conditions du site. Si les paramètres ne sont pas réglés correctement, la perte de signal se produira.</p> <p>Les paramètres de type de tension d'entrée peuvent être ajustés selon les conditions du site. Si les paramètres sont inappropriés, une perte de signal se produira.</p> <p>Le fait de ne pas suivre les instructions peut entraîner une défaillance de la protection fournie par l'équipement, ce qui peut entraîner des conséquences graves, comme des blessures ou des dommages à l'équipement.</p>

A Dimension drawing

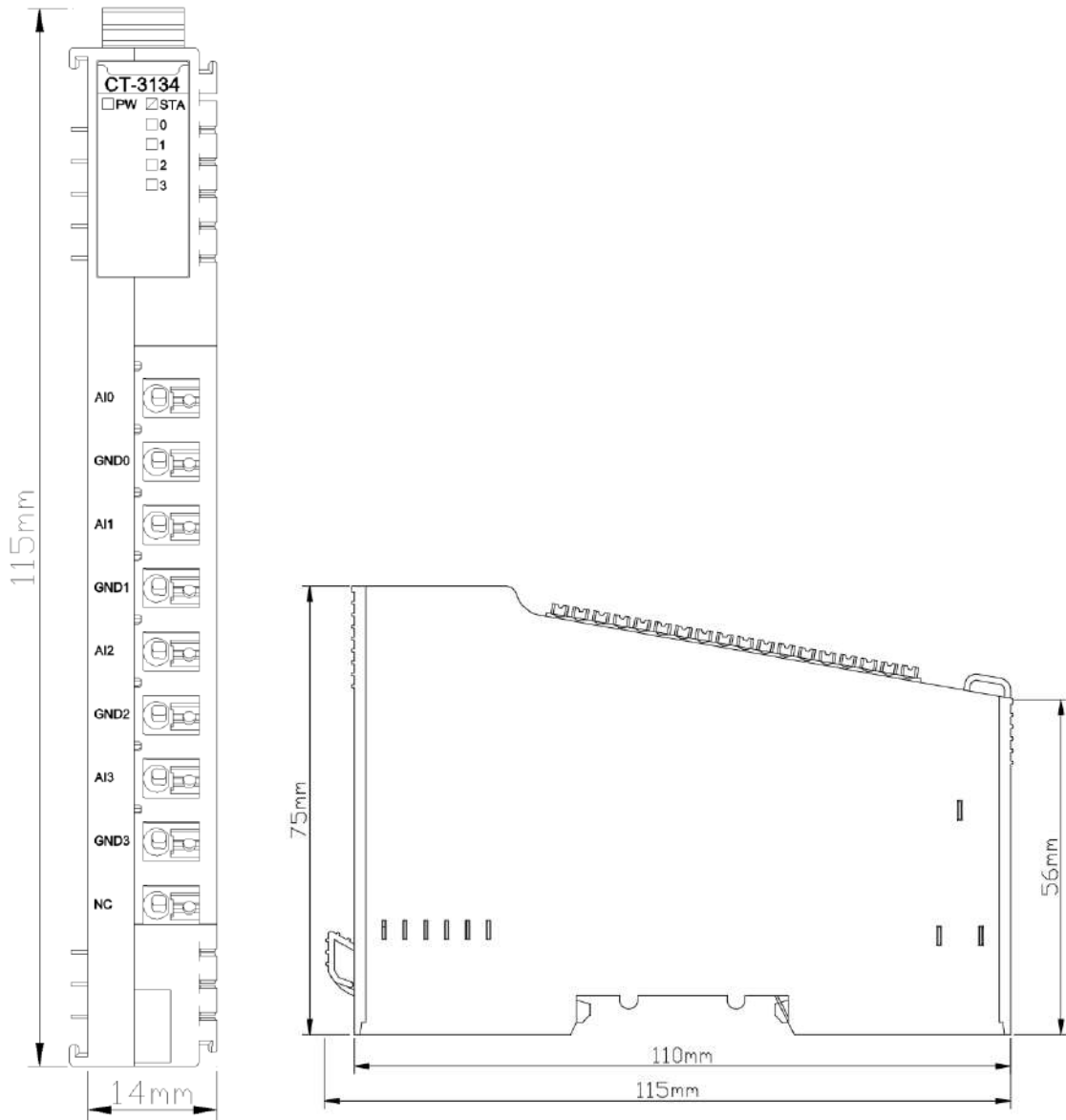

CT-3158: 8 channels voltage Input 0~5V/0~10/±5/±10VDC, 12Bits

1 Module features

- ◆ The module supports 8 channels of voltage signal input
- ◆ The module could collect 0~5VDC, 0~10VDC, ±5VDC, ±10VDC, with a 12-bit resolution
- ◆ The module carries with 8 analog input channel LED indicator
- ◆ The module input signal is a single ended common grounding input
- ◆ The filtering time could be set

2 Technical Parameters

General Parameters	
Power	Max.500mA@5.0VDC
Isolation	I/O to internal bus: opto-couple isolation (3KVrms)
Field Power	Not used
Wiring	Max.: AWG 18 Min.: AWG 24
Installation	35mm DIN-Rail
Size	115*14*75mm
Weight	65g
Environment Specification	
Operating Temperature of Horizontal Installation	-35°C~70°C
Operating Temperature of Vertical Installation	-35°C~60°C
Relative Humidity	< 95%RH (No Condensation)
Storage Temperature	-40°C~85°C
Storage Humidity	< 95%RH (No Condensation)
Manufacturing Test Temperature	-40°C~75°C
Ingress Protection Rating	IP20
Input Parameter	
Channel Number	8 channel voltage input
LED Indicator	8 channel input indicators
Input Voltage Range	0~5VDC, 0~10VDC, ±5VDC, ±10VDC
Resolution	12Bit
Accuracy	±0.3%@25°C ±0.5% @ -35~60°C
Sampling Rate	1ms/8 channels
Output Impedance	1MΩ
Common Terminal	Common Grounding Input

WARNING

UNEXPECTED EQUIPMENT OPERATION

Do not exceed any of the ratings specified in the environmental and electrical characteristics table.

Failure to follow instructions specified by the manufacturer may result in serious consequences such as death, personal injury, or damage to equipment since the protection provided by the equipment may be impaired.

AVERTISSEMENT

FONCTIONNEMENT INATTENDU DE L'EQUIPEMENT

Ne dépassez aucune évaluation spécifiée dans le tableau de caractéristiques environnementales et électriques.

Le fait de ne pas suivre les instructions peut entraîner une défaillance de la protection fournie par l'équipement, ce qui peut entraîner des conséquences graves, comme des blessures ou des dommages à l'équipement.

3 Hardware Interface

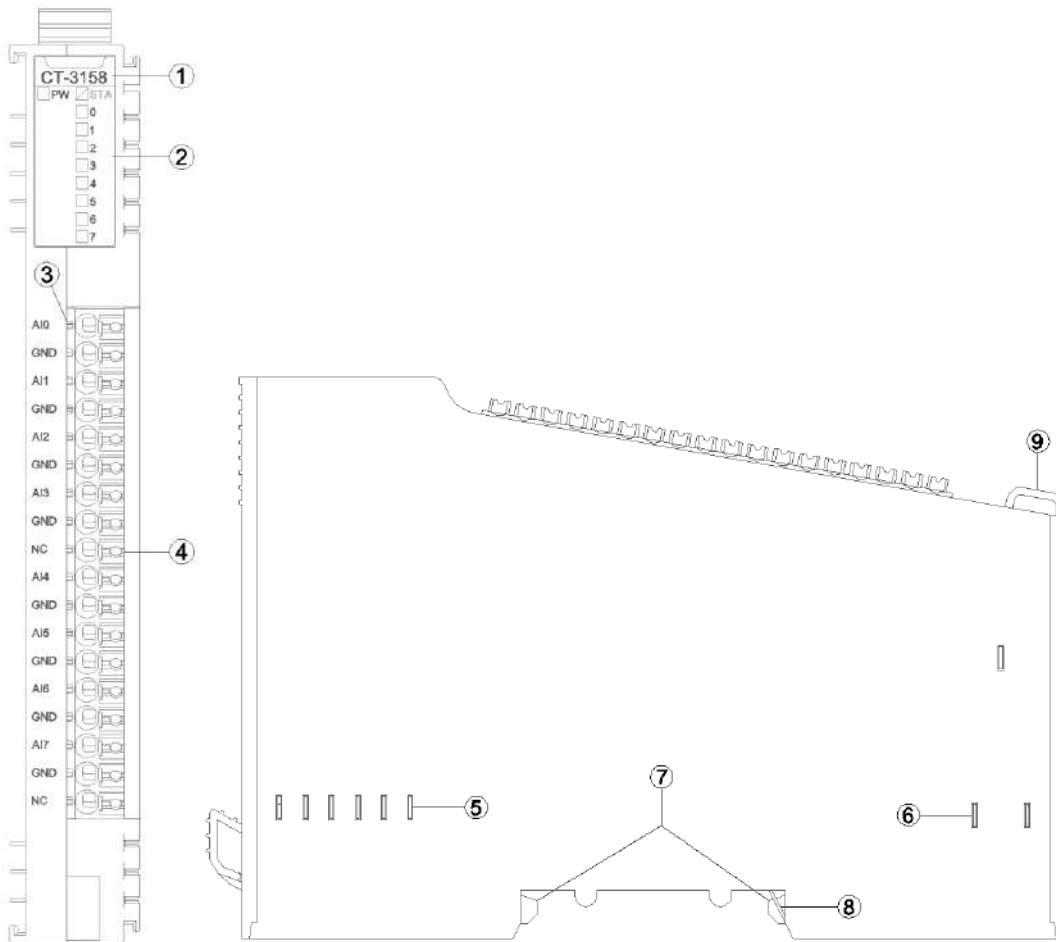

- ① Module Type
- ② State indicator
- ③ N/A
- ④ Wiring Terminal and identification
- ⑤ Internal Bus
- ⑥ Field Power
- ⑦ Buckle
- ⑧ Grounding Spring Sheet
- ⑨ Fixed Wiring Harness

3.1 LEDLED indicator definition

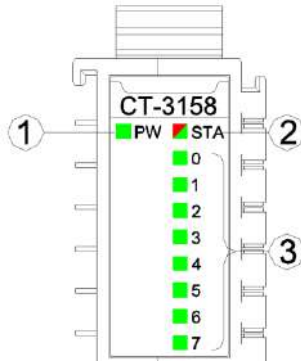

- ① Power LED indicator (green)
- ② Module State LED indicator (red/green)
- ③ Input channel LED indicator (green)

PW POWER STATE (GREEN)	Definition
ON	Internal bus Power Normal
OFF	Internal bus Power Failure
STA MODULE STATE (RED/GREEN)	Definition
Green slow flash (2.5Hz)	Module internal bus is not started
Red slow flash (2.5Hz)	Module internal bus offline
ON (GREEN)	Operation normal
Flash(2.5Hz) (RED/GREEN)	Upgrading mode
Flash(10Hz) (RED/GREEN)	Firmware Update
Double Flash (RED)	Module Exception has been soft-restarted
0-7 channel LED indicator (GREEN)	Definition
ON	The input signal exceeds 1% of the range
OFF	Invalid input signal

⚠ WARNING

UNEXPECTED EQUIPMENT OPERATION

By viewing the PW indicator, could determine the power supply status of a module. If the PW is steady green, the power supply is normal. Otherwise, the module cannot work properly.

When the module is initially powered on, there will be 3S for the backplane bus connection. After the backplane bus is initialized, STA is in the green steady state. If STA is in the green blinking state, it indicates that the backplane bus has not been initialized, and it needs to be powered off and restarted for re-initialization.

STA abnormal working state occurs during the normal operation of the module, please check the firmware version information of all modules, and consult ODOT technical support for details.

If a module is upgraded, check that all modules are in the normal state after the upgrade. Otherwise, an exception may occur.

Failure to follow instructions specified by the manufacturer may result in serious consequences such as death, personal injury, or damage to equipment since the protection provided by the equipment may be impaired.

AVERTISSEMENT

FONCTIONNEMENT INATTENDU DE L'EQUIPEMENT

En regardant l'état de l'indicateur de PW, jugez l'état d'alimentation du module. Le feu vert PW reste allumé et l'alimentation est normale. Autrement, le module ne fonctionnera pas correctement.

Lorsque le module est alimenté initialement, il y aura 3S pour la connexion de bus de backboard. STA est un état vert permanent après l'initialisation du bus de backboard. Si STA est en état de clignotement vert, cela signifie que l'initialisation du bus de backboard n'est pas passée et doit être redémarrée hors tension et réinitialisée.

L'état de fonctionnement anormal de STA se produit pendant le fonctionnement normal du module, veuillez vérifier les informations de version du firmware de tous les modules, et consulter le support technique ODOT pour plus de détails.

Si le module a une opération de mise à niveau, après l'achèvement de la mise à niveau, le besoin de vérifier que tous les modules sont dans l'état normal avant de courir, sinon il conduira à une exception.

Le fait de ne pas suivre les instructions peut entraîner une défaillance de la protection fournie par l'équipement, ce qui peut entraîner des conséquences graves, comme des blessures ou des dommages à l'équipement.

3.2 Terminal definition

Terminal Number	Definition	Description
1	AI0	Signal Input CH0
2	GND	
3	AI1	Signal Input CH1
4	GND	
5	AI2	Signal Input CH2
6	GND	
7	AI3	Signal Input CH3
8	GND	
9	NC	Not Connected
10	AI4	Signal Input CH4
11	GND	
12	AI5	Signal Input CH5
13	GND	
14	AI6	Signal Input CH6
15	GND	
16	AI7	Signal Input CH7
17	GND	
18	NC	Not Connected

WARNING

UNEXPECTED EQUIPMENT OPERATION

Calculate the maximum field power current consumption of a single module based on the actual field load. If the total field power current consumption of all I/O modules exceeds the power supply capacity of the field power supply, you must add an extra power expansion module. Otherwise, an output channel exception may occur.

Failure to follow instructions specified by the manufacturer may result in serious consequences such as death, personal injury, or damage to equipment since the protection provided by the equipment may be impaired.

AVERTISSEMENT

FONCTIONNEMENT INATTENDU DE L'EQUIPEMENT

Calculez la consommation maximale de courant de champ d'un seul module en fonction de la charge de champ réelle. Si la consommation totale de courant de champ de tous les modules d'E/S dépasse la capacité d'alimentation de l'alimentation de champ, vous devez ajouter un module d'extension de puissance supplémentaire. Dans le cas contraire, une exception de canal de sortie peut se produire.

Le fait de ne pas suivre les instructions peut entraîner une défaillance de la protection fournie par l'équipement, ce qui peut entraîner des conséquences graves, comme des blessures ou des dommages à l'équipement.

When connecting a cold-pressed terminal, the terminal must be terminated and checked in strict accordance with the corresponding termination specifications or requirements, and connect the cold-pressed terminal according to the corresponding node serial number. The conductor should use copper conductor and the conductor core should be larger than 0.2mm^2 and smaller than 1mm^2 (AWG18~AWG24). Cold-pressed terminal parameters are as follows:

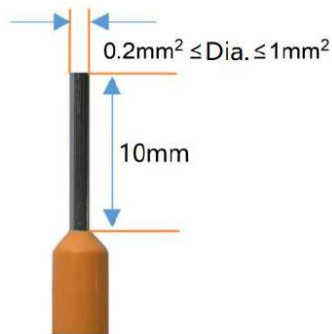

⚠️ WARNING

UNEXPECTED EQUIPMENT OPERATION

Strip the length of the conductor insulation layer is greater than 10mm to ensure reliable signal connection.

The wire needs to use copper wire and the wire core is greater than or equal to 0.2mm^2 and less than or equal to 1mm^2 to ensure reliable signal connection.

When connecting a cold-press terminal, connect the cold-press terminal strictly in accordance with the corresponding termination specifications or requirements, and connect the cold-press terminal according to the corresponding node serial number.

Do not power on cold-press terminals until they are properly connected or fully locked.

Failure to follow instructions specified by the manufacturer may result in serious consequences such as death, personal injury, or damage to equipment since the protection provided by the equipment may be impaired.

⚠️ AVERTISSEMENT

FONCTIONNEMENT INATTENDU DE L'EQUIPEMENT

Dépouillez la longueur de la couche isolante du fil plus de 10mm pour assurer la connexion fiable du signal.

Le conducteur doit utiliser le fil de cuivre et le noyau de fil est supérieur ou égal à $0,2\text{ mm}^2$, inférieur ou égal à 1mm^2 , afin d'assurer la connexion fiable du signal.

Lorsque les terminaux de presse à froid sont terminés, ils doivent être terminés et visualisés en stricte conformité avec les spécifications ou les exigences correspondantes et terminés selon le

numéro de série de noeud correspondant.

Il est interdit d'activer les bornes à froid avant qu'elles ne soient correctement articulées ou complètement verrouillées.

Le fait de ne pas suivre les instructions peut entraîner une défaillance de la protection fournie par l'équipement, ce qui peut entraîner des conséquences graves, comme des blessures ou des dommages à l'équipement.

DANGER

FIRE DANGER

Use the correct wiring rules only for the maximum current capacity of the I/O channel and power supply.

Failure to follow instructions specified by the manufacturer may result in serious consequences such as death, personal injury, or damage to equipment since the protection provided by the equipment may be impaired.

WARNING

UNEXPECTED EQUIPMENT OPERATION

Do not exceed any of the ratings specified in the environmental and electrical characteristics table.

Failure to follow instructions specified by the manufacturer may result in serious consequences such as death, personal injury, or damage to equipment since the protection provided by the equipment may be impaired.

AVERTISSEMENT

FONCTIONNEMENT INATTENDU DE L'EQUIPEMENT

Ne dépassez aucune évaluation spécifiée dans le tableau de caractéristiques environnementales et électriques..

Le fait de ne pas suivre les instructions peut entraîner une défaillance de la protection fournie par l'équipement, ce qui peut entraîner des conséquences graves, comme des blessures ou des dommages à l'équipement.

4 Wiring

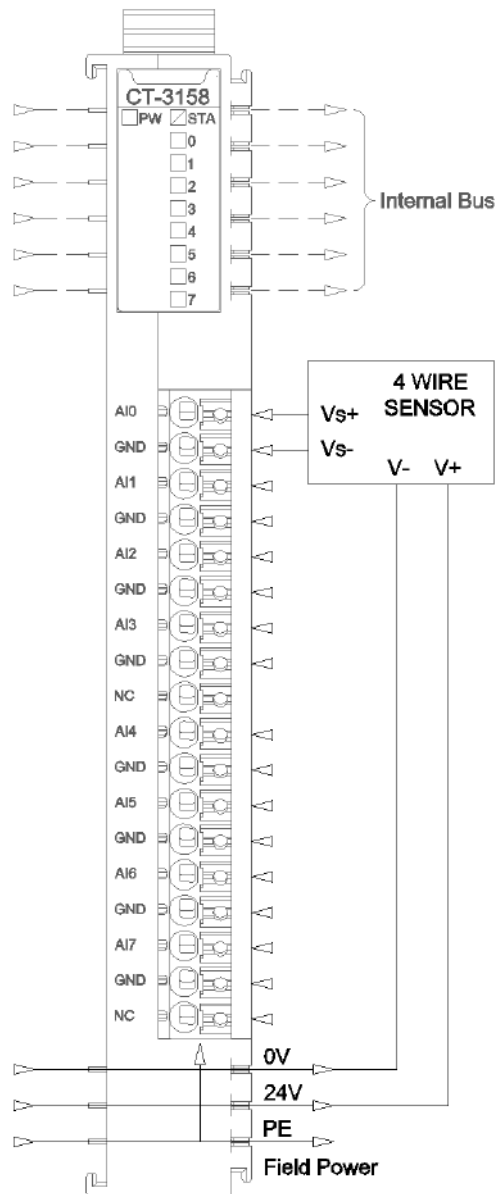

NOTICE

EQUIPMENT INOPERABLE

Do not crimp the spring terminal with more than the maximum pressure specified for the terminal. Otherwise, the resilience of the spring terminal may be damaged and the terminal rebound may be affected.

Do not press the spring terminal with a sharp tool when removing cable from the channel. Otherwise, the spring terminal will be damaged.

Failure to follow these instructions may result in equipment damage.

 **WARNING**

UNEXPECTED EQUIPMENT OPERATION

Do not link wires to unused terminals and/or terminals marked "NO CONNECTION (NC)"
Failure to follow instructions specified by the manufacturer may result in serious consequences such as death, personal injury, or damage to equipment since the protection provided by the equipment may be impaired.

 **AVERTISSEMENT**

FONCTIONNEMENT INATTENDU DE L'EQUIPEMENT

Ne reliez pas les fils aux terminaux inutilisés et/ou aux terminaux marqués «NO CONNECTION (NC)»

Le fait de ne pas suivre les instructions peut entraîner une défaillance de la protection fournie par l'équipement, ce qui peut entraîner des conséquences graves, comme des blessures ou des dommages à l'équipement.

5 Process data definition

Input Data								
Bit No	Bit 7	Bit 6	Bit 5	Bit 4	Bit 3	Bit 2	Bit 1	Bit 0
Byte 0	Analog Input Data (CH 0)							
Byte 1								
Byte 2	Analog Input Data (CH 1)							
Byte 3								
Byte 4	Analog Input Data (CH 2)							
Byte 5								
Byte 6	Analog Input Data (CH 3)							
Byte 7								
Byte 8	Analog Input Data (CH 4)							
Byte 9								
Byte 10	Analog Input Data (CH 5)							
Byte 11								
Byte 12	Analog Input Data (CH 6)							
Byte 13								
Byte 14	Analog Input Data (CH 7)							
Byte 15								

Data description:

Analog Input Data (CH0-7): Voltage input data value

Process Data Definition (8AI)					
Voltage(0-5V)	Voltage (0-10V)	Voltage (±5V)	Voltage (±10V)	Decimal	Hex
5	10	5	10	4095	0x0FFF
.
.
2.5	5	2.5	5	2047	0x07FF
.
.
0	0	0	0	0	0x0000
/	/
/	/
/	/	-2.5	-5	-2047	0xF801
/	/
/	/
/	/	-5	-10	-4095	0xF001

6 Configuration parameters definition

Configuration parameters								
Bit No	Bit 7	Bit 6	Bit 5	Bit 4	Bit 3	Bit 2	Bit 1	Bit 0
Byte 0	Reserved							16Bit Data Format
Byte 1	Voltage Type (CH 3)		Voltage Type (CH 2)		Voltage Type (CH 1)		Voltage Type (CH 0)	
Byte 2	Voltage Type (CH 7)		Voltage Type (CH 6)		Voltage Type (CH 5)		Voltage Type (CH 4)	
Byte 3	Filtering Time(CH0)							
Byte 4								
Byte 5	Filtering Time(CH1)							
Byte 6								
Byte 7	Filtering Time(CH2)							
Byte 8								
Byte 9	Filtering Time(CH3)							
Byte 10								
Byte 11	Filtering Time(CH4)							
Byte 12								
Byte 13	Filtering Time(CH5)							
Byte 14								
Byte 15	Filtering Time(CH6)							
Byte 16								
Byte 17	Filtering Time(CH7)							
Byte 18								

Data description:

16Bit Data Format: Sequence of 16-bit data byte transmission (Default:0)

0: A_B。

1: B_A。

Voltage Type(CH 0-7): Input voltage type (Default:2)

0: 0~5VDC。



1: -5~5VDC。

2: 0~10VDC。

3: -10~10VDC。

Filtering Time(CH0-CH7): The input filtering time of the channel, unit in “ms”.

(Default: 10)

 WARNING
<p>UNEXPECTED EQUIPMENT OPERATION</p> <p>The filtering parameters could be adjusted according to the field conditions. If the parameter settings are inappropriate, the signal will be lost.</p> <p>Input voltage type parameters can be adjusted according to the site conditions. If the parameter Settings are inappropriate, signal loss will occur.</p> <p>Failure to follow instructions specified by the manufacturer may result in serious consequences such as death, personal injury, or damage to equipment since the protection provided by the equipment may be impaired.</p>
 AVERTISSEMENT
<p>FONCTIONNEMENT INATTENDU DE L'EQUIPEMENT</p> <p>Les paramètres de filtrage peuvent être ajustés en fonction des conditions du site. Si les paramètres ne sont pas réglés correctement, la perte de signal se produira.</p> <p>Les paramètres de type de tension d'entrée peuvent être ajustés selon les conditions du site. Si les paramètres sont inappropriés, une perte de signal se produira.</p> <p>Le fait de ne pas suivre les instructions peut entraîner une défaillance de la protection fournie par l'équipement, ce qui peut entraîner des conséquences graves, comme des blessures ou des dommages à l'équipement.</p>

A Dimension drawing

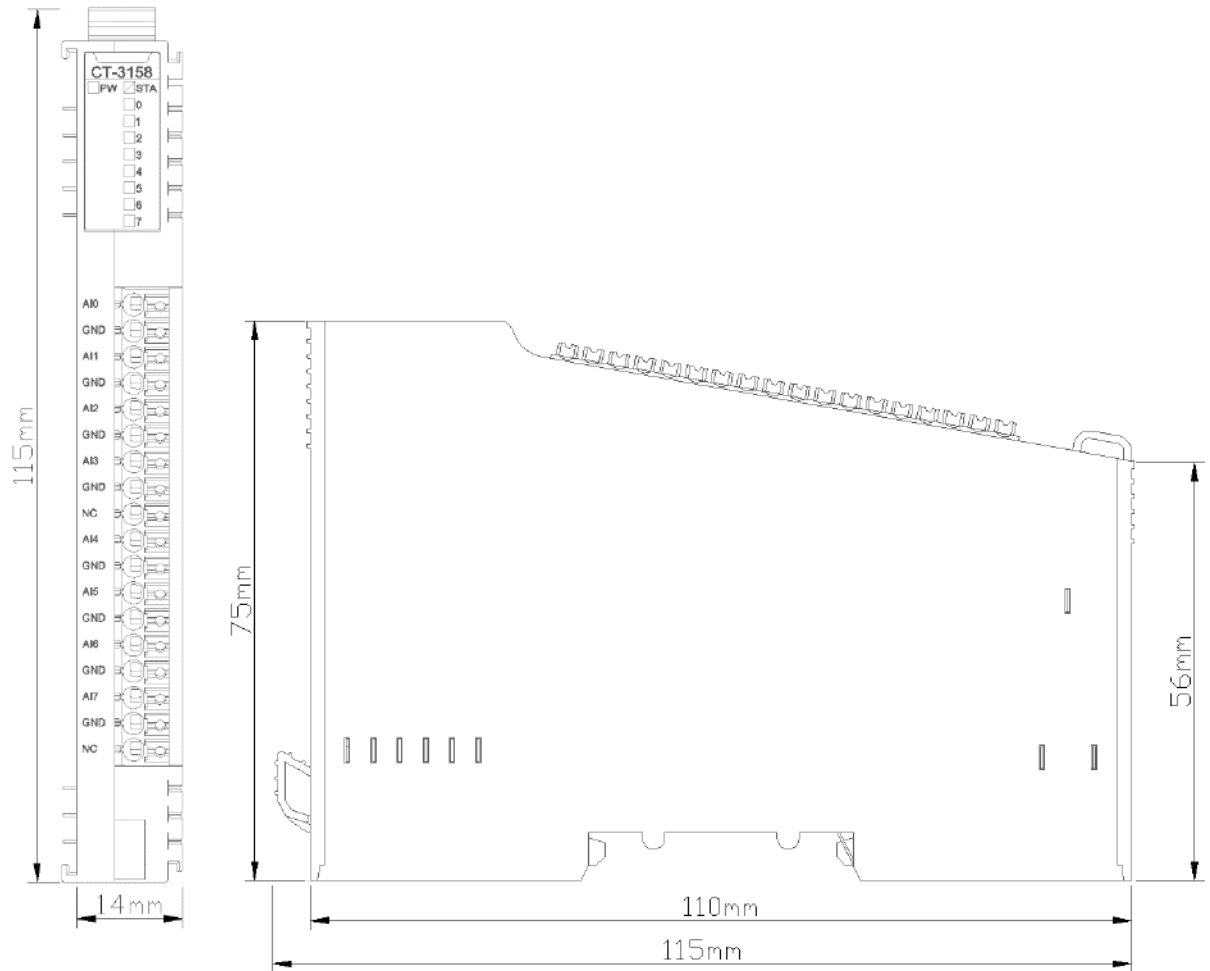

CT-3168 8 channels voltage Input
0~5/0~10/±5/±10VDC, 15Bit/16 Bit

1 Module features

- ◆ The module supports 8 channels of voltage signal input
- ◆ The module could collect 0~5VDC, 0~10VDC, ±5VDC, ±10VDC, with a 15-bit or 16-bit resolution
- ◆ The module carries with 8 analog input channel LED indicator
- ◆ The module input signal is a single ended common grounding input
- ◆ Filter time could be set
- ◆ Channels could be disabled independently

2 Technical Parameters

General Parameters	
Power	Max.100mA@5.0VDC
Isolation	I/O to internal bus: opto-couple isolation (3KVrms)
Field Power	Not used
Wiring	Max.: AWG 18 Min.: AWG 24
Installation	35mmDIN-Rail
Size	115*14*75mm
Weight	65g
Environment Specification	
Operating Temperature of Horizontal Installation	-35°C~70°C
Operating Temperature of Vertical Installation	-35°C~60°C
Relative Humidity	< 95%RH (No Condensation)
Storage Temperature	-40°C~85°C
Storage Humidity	< 95%RH (No Condensation)
Manufacturing Test Temperature	-40°C~75°C
Ingress Protection Rating	IP20
Input Parameter	
Channel Number	8 channel voltage input
LED Indicator	8 channel input indicators
Input Voltage Range	0~5VDC, 0~10VDC, ±5VDC, ±10VDC
Resolution	15Bit/16Bit
Accuracy	±0.3%@25°C ±0.5% @ -35~60°C
Sampling Speed	1ms/8 channels
Output Impedance	1MΩ
Common Terminal	Common Grounding Input
Channel Disable	supported
Diagnostic Function	Channel disabled fault value: -32767 Overflow: 32767 (Overflow failure value supported only in standard mode) Underflow: -32768(Underflow fault value supported only in standard mode)

WARNING

UNEXPECTED EQUIPMENT OPERATION

Do not exceed any of the ratings specified in the environmental and electrical characteristics table.

Failure to follow instructions specified by the manufacturer may result in serious consequences such as death, personal injury, or damage to equipment since the protection

provided by the equipment may be impaired.

 **AVERTISSEMENT**

FONCTIONNEMENT INATTENDU DE L'EQUIPEMENT

Ne dépassez aucune évaluation spécifiée dans le tableau de caractéristiques environnementales et électriques.

Le fait de ne pas suivre les instructions peut entraîner une défaillance de la protection fournie par l'équipement, ce qui peut entraîner des conséquences graves, comme des blessures ou des dommages à l'équipement.

3 Hardware Interface

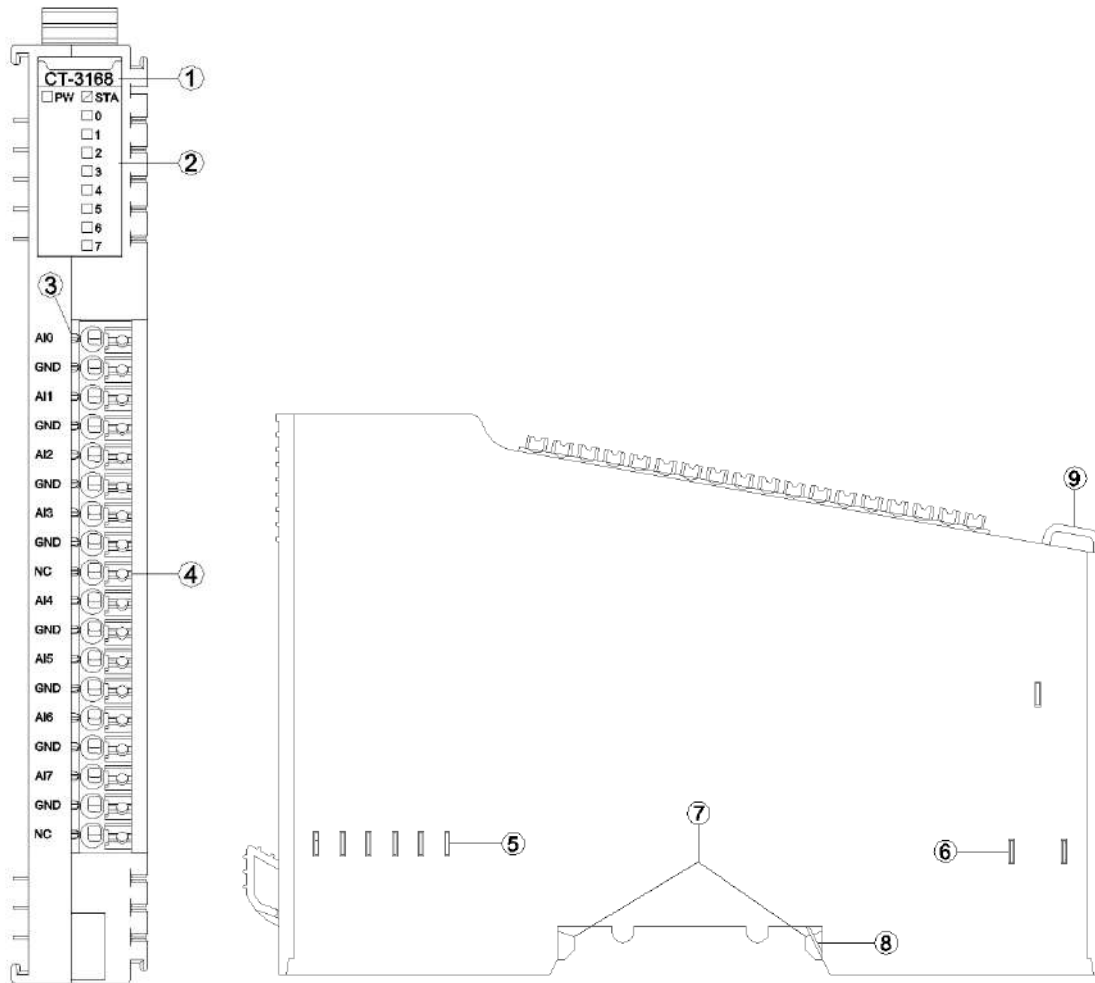

- ① Module Type
- ② State indicator
- ③ N/A
- ④ Wiring Terminal and identification
- ⑤ Internal Bus
- ⑥ Field Power
- ⑦ Buckle
- ⑧ Grounding Spring Sheet
- ⑨ Fixed Wiring Harness

3.1 LED indicator definition

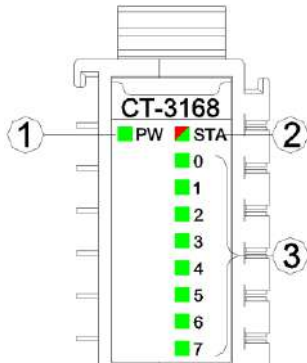

- ① Power LED indicator (green)
- ② Module State LED indicator (red/green)
- ③ Input channel LED indicator (green)

PW POWER STATE (GREEN)	Definition
ON	Internal bus Power Normal
OFF	Internal bus Power Failure
STA MODULE STATE (RED/GREEN)	Definition
Green slow flash (2.5Hz)	Module internal bus is not started
Red slow flash (2.5Hz)	Module internal bus offline
ON (GREEN)	Operation normal
Flash(2.5Hz) (RED/GREEN)	Upgrading mode
Flash(10Hz) (RED/GREEN)	Firmware Update
Double Flash (RED)	Module Exception has been soft-restarted
0-7 channel LED indicator (GREEN)	Definition
ON	Input signal exceeds 0.15V or -0.15V
OFF	Invalid input signal

⚠ WARNING

UNEXPECTED EQUIPMENT OPERATION

By viewing the PW indicator, could determine the power supply status of a module. If the PW is steady green, the power supply is normal. Otherwise, the module cannot work properly.

When the module is initially powered on, there will be 3S for the backplane bus connection. After the backplane bus is initialized, STA is in the green steady state. If STA is in the green blinking state, it indicates that the backplane bus has not been initialized, and it needs to be powered off and restarted for re-initialization.

STA abnormal working state occurs during the normal operation of the module, please check the firmware version information of all modules, and consult ODOT technical support for details.

If a module is upgraded, check that all modules are in the normal state after the upgrade. Otherwise, an exception may occur.

Failure to follow instructions specified by the manufacturer may result in serious consequences such as death, personal injury, or damage to equipment since the protection provided by the equipment may be impaired.

AVERTISSEMENT

FONCTIONNEMENT INATTENDU DE L'EQUIPEMENT

En regardant l'état de l'indicateur de PW, jugez l'état d'alimentation du module. Le feu vert PW reste allumé et l'alimentation est normale. Autrement, le module ne fonctionnera pas correctement.

Lorsque le module est alimenté initialement, il y aura 3S pour la connexion de bus de backboard. STA est un état vert permanent après l'initialisation du bus de backboard. Si STA est en état de clignotement vert, cela signifie que l'initialisation du bus de backboard n'est pas passée et doit être redémarrée hors tension et réinitialisée.

L'état de fonctionnement anormal de STA se produit pendant le fonctionnement normal du module, veuillez vérifier les informations de version du firmware de tous les modules, et consulter le support technique ODOT pour plus de détails.

Si le module a une opération de mise à niveau, après l'achèvement de la mise à niveau, le besoin de vérifier que tous les modules sont dans l'état normal avant de courir, sinon il conduira à une exception.

Le fait de ne pas suivre les instructions peut entraîner une défaillance de la protection fournie par l'équipement, ce qui peut entraîner des conséquences graves, comme des blessures ou des dommages à l'équipement.

3.2 Terminal definition

Terminal Number	Definition	Description
1	AI0	Signal Input CH0
2	GND	
3	AI1	Signal Input CH1
4	GND	
5	AI2	Signal Input CH2
6	GND	
7	AI3	Signal Input CH3
8	GND	
9	NC	Not Connected
10	AI4	Signal Input CH4
11	GND	
12	AI5	Signal Input CH5
13	GND	
14	AI6	Signal Input CH6
15	GND	
16	AI7	Signal Input CH7
17	GND	
18	NC	Not Connected

WARNING

UNEXPECTED EQUIPMENT OPERATION

Calculate the maximum field power current consumption of a single module based on the actual field load. If the total field power current consumption of all I/O modules exceeds the power supply capacity of the field power supply, you must add an extra power expansion module. Otherwise, an output channel exception may occur.

Failure to follow instructions specified by the manufacturer may result in serious consequences such as death, personal injury, or damage to equipment since the protection provided by the equipment may be impaired.

AVERTISSEMENT

FONCTIONNEMENT INATTENDU DE L'EQUIPEMENT

Calculez la consommation maximale de courant de champ d'un seul module en fonction de la charge de champ réelle. Si la consommation totale de courant de champ de tous les modules d'E/S dépasse la capacité d'alimentation de l'alimentation de champ, vous devez ajouter un module d'extension de puissance supplémentaire. Dans le cas contraire, une exception de canal de sortie peut se produire.

Le fait de ne pas suivre les instructions peut entraîner une défaillance de la protection fournie par l'équipement, ce qui peut entraîner des conséquences graves, comme des blessures ou des dommages à l'équipement.

When connecting a cold-pressed terminal, the terminal must be terminated and checked in strict accordance with the corresponding termination specifications or requirements, and connect the cold-pressed terminal according to the corresponding node serial number. The conductor should use copper conductor and the conductor core should be larger than 0.2mm^2 and smaller than 1mm^2 (AWG18~AWG24). Cold-pressed terminal parameters are as follows:



⚠️ WARNING

UNEXPECTED EQUIPMENT OPERATION

Strip the length of the conductor insulation layer is greater than 10mm to ensure reliable signal connection.

The wire needs to use copper wire and the wire core is greater than or equal to 0.2mm^2 and less than or equal to 1mm^2 to ensure reliable signal connection.

When connecting a cold-press terminal, connect the cold-press terminal strictly in accordance with the corresponding termination specifications or requirements, and connect the cold-press terminal according to the corresponding node serial number.

Do not power on cold-press terminals until they are properly connected or fully locked.

Failure to follow instructions specified by the manufacturer may result in serious consequences such as death, personal injury, or damage to equipment since the protection provided by the equipment may be impaired.

⚠️ AVERTISSEMENT

FONCTIONNEMENT INATTENDU DE L'EQUIPEMENT

Dépouillez la longueur de la couche isolante du fil plus de 10mm pour assurer la connexion fiable du signal.

Le conducteur doit utiliser le fil de cuivre et le noyau de fil est supérieur ou égal à $0,2\text{ mm}^2$, inférieur ou égal à 1mm^2 , afin d'assurer la connexion fiable du signal.

Lorsque les terminaux de presse à froid sont terminés, ils doivent être terminés et visualisés en stricte conformité avec les spécifications ou les exigences correspondantes et terminés selon le

numéro de série de noeud correspondant.

Il est interdit d'activer les bornes à froid avant qu'elles ne soient correctement articulées ou complètement verrouillées.

Le fait de ne pas suivre les instructions peut entraîner une défaillance de la protection fournie par l'équipement, ce qui peut entraîner des conséquences graves, comme des blessures ou des dommages à l'équipement.

DANGER

FIRE DANGER

Use the correct wiring rules only for the maximum current capacity of the I/O channel and power supply.

Failure to follow instructions specified by the manufacturer may result in serious consequences such as death, personal injury, or damage to equipment since the protection provided by the equipment may be impaired.

WARNING

UNEXPECTED EQUIPMENT OPERATION

Do not exceed any of the ratings specified in the environmental and electrical characteristics table.

Failure to follow instructions specified by the manufacturer may result in serious consequences such as death, personal injury, or damage to equipment since the protection provided by the equipment may be impaired.

AVERTISSEMENT

FONCTIONNEMENT INATTENDU DE L'EQUIPEMENT

Ne dépassez aucune évaluation spécifiée dans le tableau de caractéristiques environnementales et électriques..

Le fait de ne pas suivre les instructions peut entraîner une défaillance de la protection fournie par l'équipement, ce qui peut entraîner des conséquences graves, comme des blessures ou des dommages à l'équipement.

4 Wiring

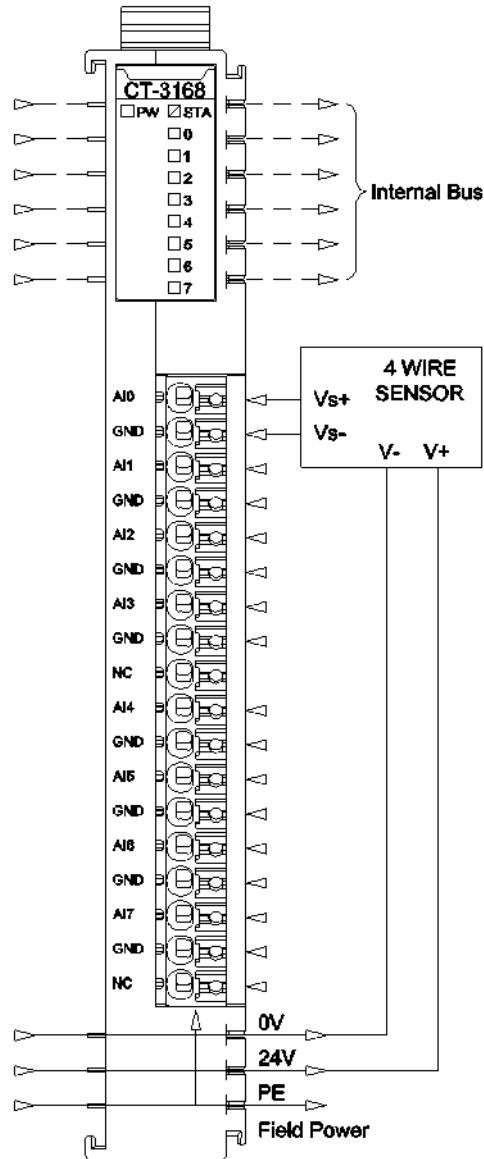

NOTICE

EQUIPMENT INOPERABLE

Do not crimp the spring terminal with more than the maximum pressure specified for the terminal. Otherwise, the resilience of the spring terminal may be damaged and the terminal rebound may be affected.

Do not press the spring terminal with a sharp tool when removing cable from the channel. Otherwise, the spring terminal will be damaged.

Failure to follow these instructions may result in equipment damage.

 **WARNING**

UNEXPECTED EQUIPMENT OPERATION

Do not link wires to unused terminals and/or terminals marked "NO CONNECTION (NC)"
Failure to follow instructions specified by the manufacturer may result in serious consequences such as death, personal injury, or damage to equipment since the protection provided by the equipment may be impaired.

 **AVERTISSEMENT**

FONCTIONNEMENT INATTENDU DE L'EQUIPEMENT

Ne reliez pas les fils aux terminaux inutilisés et/ou aux terminaux marqués «NO CONNECTION (NC)»
Le fait de ne pas suivre les instructions peut entraîner une défaillance de la protection fournie par l'équipement, ce qui peut entraîner des conséquences graves, comme des blessures ou des dommages à l'équipement.

5 Process data definition

Input Data								
Bit No	Bit 7	Bit 6	Bit 5	Bit 4	Bit 3	Bit 2	Bit 1	Bit 0
Byte 0	Analog Input Data (CH 0)							
Byte 1								
Byte 2	Analog Input Data (CH 1)							
Byte 3								
Byte 4	Analog Input Data (CH 2)							
Byte 5								
Byte 6	Analog Input Data (CH 3)							
Byte 7								
Byte 8	Analog Input Data (CH 4)							
Byte 9								
Byte 10	Analog Input Data (CH 5)							
Byte 11								
Byte 12	Analog Input Data (CH 6)							
Byte 13								
Byte 14	Analog Input Data (CH 7)							
Byte 15								

5.1 Process data definition (standard mode)

Data description:

Analog Input Data (CH0-7): Voltage input data value

Process data definition (8AI)						
Voltage (0-5V)	Voltage (0-10V)	Voltage ($\pm 5V$)	Voltage ($\pm 10V$)	Decimal	Hex	Range
>5.06	>10.12	>5.06	>10.12	32767	0x7FFF	Overflow
5.06	10.12	5.06	10.12	27979	0x6D4B	Exceeds the upper limit
5V+0.1808mv	10V+0.3617mv	5V+0.1808mv	10V+0.3617mv	27649	0x6C01	
5	10	5	10	27648	0x6C00	Rated range
.	
.	
2.5	5	2.5	5	13824	0x3600	
.	
.	
0	0	0	0	0	0x0000	
/	/	
/	/	
/	/	-2.5	-5	-13824	0XCA00	
/	/	
/	/	

/	/	-5	-10	-27648	0x9400	
/	/	-5V-0.1808mv	-10V-0.3617mv	-27649	0x93FF	Exceeds the lower limit
/	/	-5.06	-10.12	-27979	0x92B5	
/	/	-5.06	-10.12	-32767	0x7FFF	Channel disabled
/	/	-5.06<	-10.12<	-32768	0x8000	Underflow

5.2 Process data definition (special mode)

Process data definition (8AI)					
Voltage (0-5V)	Voltage (0-10V)	Voltage (±5V)	Voltage (±10V)	Decimal	Hex
5	10	5	10	32767	0x7FFF
.
.
2.5	5	2.5	5	16383	0x3FFF
.
.
0	0	0	0	0	0x0000
/	/
/	/
/	/	-2.5	-5	-16384	0xC000
/	/
/	/
/	/	-5	-10	-32768	0x8000

6 Configuration parameters definition

Configuration Parameters								
Bit No	Bit 7	Bit 6	Bit 5	Bit 4	Bit 3	Bit 2	Bit 1	Bit 0
Byte 0	Reserved						Range_Mode	16Bit Data Format
Byte 1	Voltage Type (CH 1)			Voltage Type (CH 0)				
Byte 2	Voltage Type (CH 3)			Voltage Type (CH 2)				
Byte 3	Voltage Type (CH 5)			Voltage Type (CH 4)				
Byte 4	Voltage Type (CH 7)			Voltage Type (CH 6)				
Byte 5	Filtering Time (CH0)							
Byte 6								
Byte 7	Filtering Time (CH1)							
Byte 8								
Byte 9	Filtering Time (CH2)							
Byte 10								
Byte 11	Filtering Time (CH3)							
Byte 12								
Byte 13	Filtering Time (CH4)							
Byte 14								
Byte 15	Filtering Time (CH5)							
Byte 16								
Byte 17	Filtering Time (CH6)							
Byte 18								
Byte 19	Filtering Time (CH7)							
Byte 20								
Byte 21 ... Byte 29	Reserved							

Data description:

16Bit Data Format: Sequence of 16-bit data byte transmission (Default:0)

0: A_B。

1: B_A。

Range_Mode: Process data mode (default: standard mode)

Standard mode: same with Siemens process data definition

Special mode: max range of the hardware

Voltage Type(CH 0-7): Input voltage type (Default:3)

0: disabled

1: 0~5VDC

2: -5~5VDC

3: 0~10VDC

4: -10~10VDC

Filtering Time(CH0-CH7): The input filtering time of the channel, in ms. (Default: 10)

WARNING

UNEXPECTED EQUIPMENT OPERATION

The filtering parameters could be adjusted according to the field conditions. If the parameter settings are inappropriate, the signal will be lost.

Input voltage type parameters can be adjusted according to the site conditions. If the parameter Settings are inappropriate, signal loss will occur.

Failure to follow instructions specified by the manufacturer may result in serious consequences such as death, personal injury, or damage to equipment since the protection provided by the equipment may be impaired.

AVERTISSEMENT

FONCTIONNEMENT INATTENDU DE L'EQUIPEMENT

Les paramètres de filtrage peuvent être ajustés en fonction des conditions du site. Si les paramètres ne sont pas réglés correctement, la perte de signal se produira.

Les paramètres de type de tension d'entrée peuvent être ajustés selon les conditions du site. Si les paramètres sont inappropriés, une perte de signal se produira.

Le fait de ne pas suivre les instructions peut entraîner une défaillance de la protection fournie par l'équipement, ce qui peut entraîner des conséquences graves, comme des blessures ou des dommages à l'équipement.

A Dimension drawing

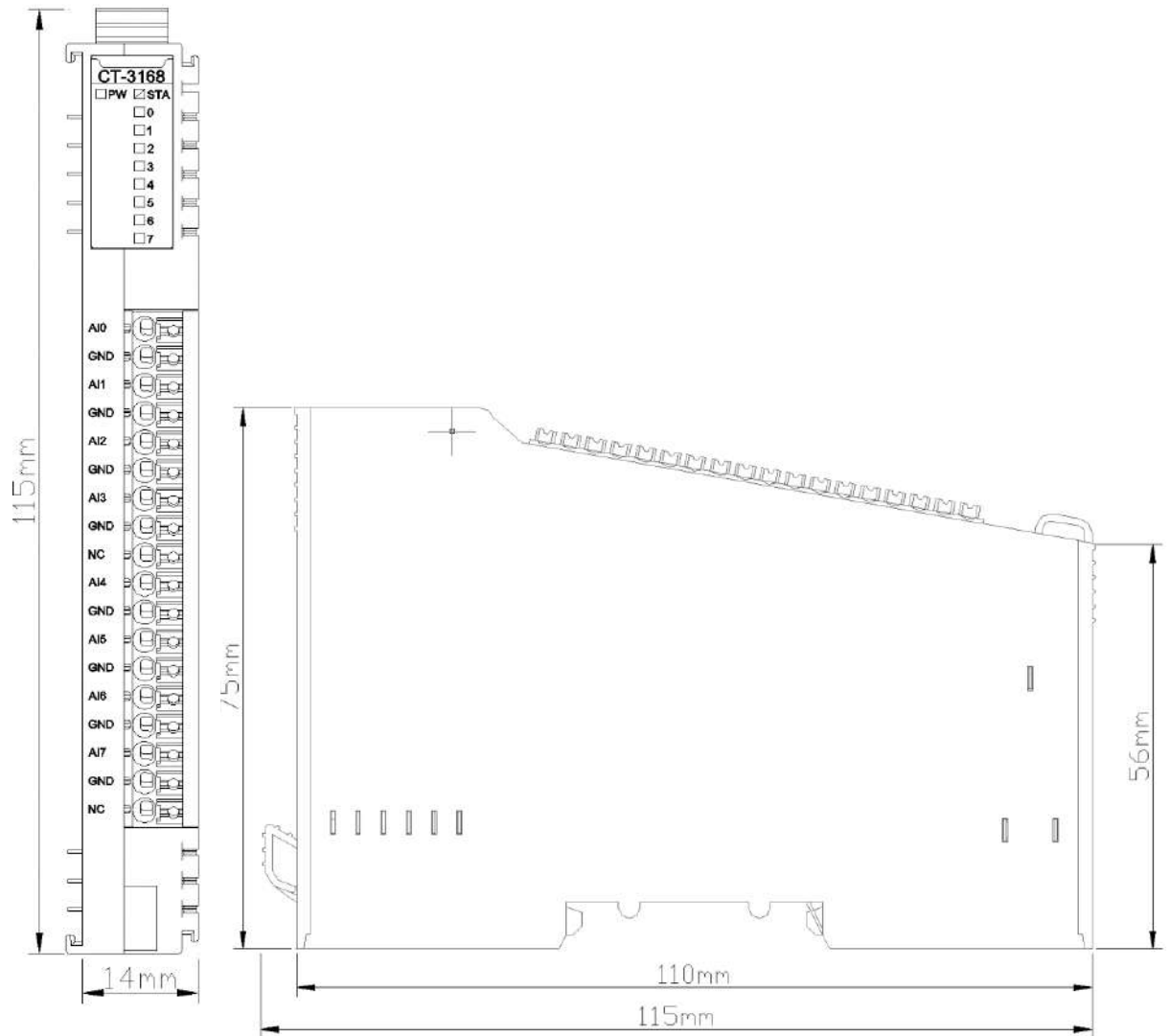

CT-3234 4 channels analog input /0&4-20mA/15-bit single-ended

1 Module features

- ◆ The module supports 4-channel current signal acquisition.
- ◆ The module can be configured for 0-20mA or 4-20mA current signal acquisition.
- ◆ The module supports 2-wire (non-loop output, external power supply is required) or 4-wire current sensor input.
- ◆ The internal bus of the module and field input adopts magnetic insulation.
- ◆ The module input channel is connected to the field active analog signal current output sensor.
- ◆ The module channel equips with TVS overvoltage protection.

2 Technical parameters

General Parameters	
Power	Max.65mA@5.0VDC
Isolation	I/O to internal bus: magnetic isolation (2.5KVrms) Power isolation: DC-DC
Wiring	Max.: AWG 18 Min.: AWG 24
Installation	35mm DIN-Rail
Size	115*14*75mm
Weight	65g
Vibration Resistance	Comply with IEC 61131-2 and EC 60068-2-6
Impact resistance	Comply with IEC 61131-2 and IEC 60068-2-27
EMC Performance	Comply with IEC 61131-2 and IEC 61000-4
Environmental parameters	
Operating Temperature of Horizontal Installation	-35°C~70°C
Operating Temperature of Vertical Installation	-35°C~60°C
Relative Humidity	< 95%RH (No Condensation)
Storage Temperature	-40°C~85°C
Storage Humidity	< 95%RH (No Condensation)
Manufacturing Test Temperature	-40°C~75°C
Ingress Protection Rating	IP20
Input Parameters	
Channel Number	4 channels
LED Indicator	4 LED channel state indicators
Input Range	Maximum: 0 ~ 23.5 mA
Resolution Ratio	15 Bits
Acquisition Precision	±0.3% full range, @25°C
	±0.5% full range, @-20~70°C
Sampling Rate	6ms / 4 channels (filter level 0)
Data Format	16-bit signed integer

 **WARNING**

UNEXPECTED EQUIPMENT OPERATION

Do not exceed any of the ratings specified in the environmental and electrical characteristics table.

Failure to follow instructions specified by the manufacturer may result in serious consequences such as death, personal injury, or damage to equipment since the protection provided by the equipment may be impaired.

 **AVERTISSEMENT**

FONCTIONNEMENT INATTENDU DE L'EQUIPEMENT

Ne dépassez aucune évaluation spécifiée dans le tableau de caractéristiques environnementales et électriques.

Le fait de ne pas suivre les instructions peut entraîner une défaillance de la protection fournie par l'équipement, ce qui peut entraîner des conséquences graves, comme des blessures ou des dommages à l'équipement.

3 Hardware interface

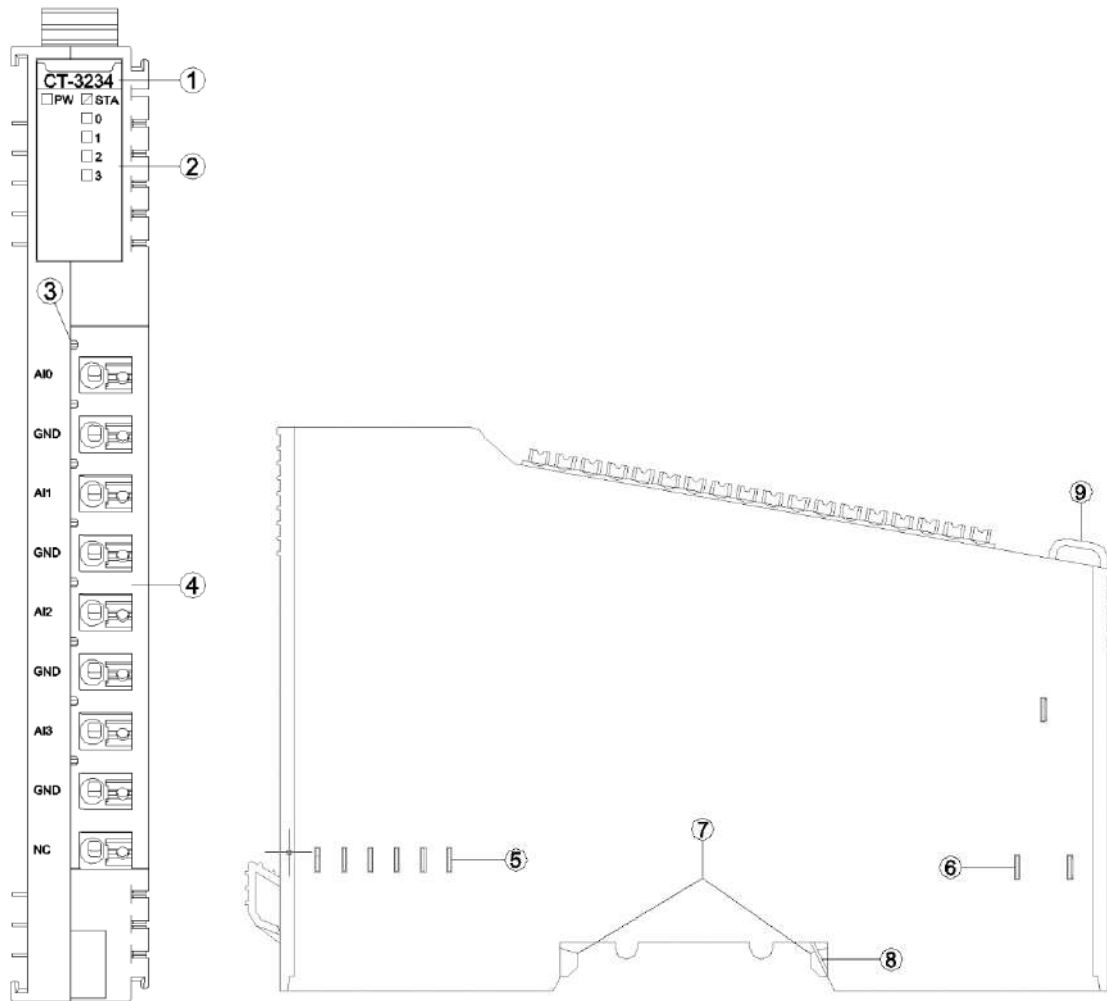

- ① Module Type
- ② State indicator
- ③ N/A
- ④ Wiring Terminal and identification
- ⑤ Internal Bus
- ⑥ Field Power
- ⑦ Buckle
- ⑧ Grounding Spring Sheet
- ⑨ Fixed Wiring Harness

3.1 LED indicator definition

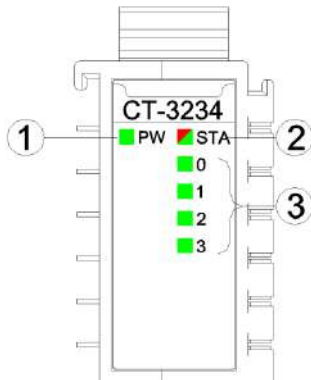

- ① Power indicator light (green)
- ② Module State indicator (red/green)
- ③ Input channel indicator light (green)

PW power indicator	Definition
ON	Internal bus power supply is normal
OFF	Internal bus power supply is failure
STA module State indicator	Definition
Green slow flash (2.5hz)	The internal bus of the module is not started
Red slow flash (2.5hz)	Module internal bus offline
Green on	Operation normal
Flash(2.5Hz) (RED/GREEN)	Upgrading mode
Flash(10Hz) (RED/GREEN)	Firmware upgrading
Red flashes twice	Module exception has been soft-restarted
0-3 channel indicator light	Definition
ON	Input signal $\geq 1\%$ range
OFF	Input signal $< 1\%$ range

⚠ WARNING

UNEXPECTED EQUIPMENT OPERATION

By viewing the PW indicator, could determine the power supply status of a module. If the PW is steady green, the power supply is normal. Otherwise, the module cannot work properly.

When the module is initially powered on, there will be 3S for the backplane bus connection. After the backplane bus is initialized, STA is in the green steady state. If STA is in the green blinking state, it indicates that the backplane bus has not been initialized, and it needs to be powered off and restarted for re-initialization.

STA abnormal working state occurs during the normal operation of the module, please check the firmware version information of all modules, and consult ODOT technical support for details.

If a module is upgraded, check that all modules are in the normal state after the upgrade. Otherwise, an exception may occur.

Failure to follow instructions specified by the manufacturer may result in serious consequences such as death, personal injury, or damage to equipment since the protection provided by the equipment may be impaired.

AVERTISSEMENT

FONCTIONNEMENT INATTENDU DE L'EQUIPEMENT

En regardant l'état de l'indicateur de PW, jugez l'état d'alimentation du module. Le feu vert PW reste allumé et l'alimentation est normale. Autrement, le module ne fonctionnera pas correctement.

Lorsque le module est alimenté initialement, il y aura 3S pour la connexion de bus de backboard. STA est un état vert permanent après l'initialisation du bus de backboard. Si STA est en état de clignotement vert, cela signifie que l'initialisation du bus de backboard n'est pas passée et doit être redémarrée hors tension et réinitialisée.

L'état de fonctionnement anormal de STA se produit pendant le fonctionnement normal du module, veuillez vérifier les informations de version du firmware de tous les modules, et consulter le support technique ODOT pour plus de détails.

Si le module a une opération de mise à niveau, après l'achèvement de la mise à niveau, le besoin de vérifier que tous les modules sont dans l'état normal avant de courir, sinon il conduira à une exception.

Le fait de ne pas suivre les instructions peut entraîner une défaillance de la protection fournie par l'équipement, ce qui peut entraîner des conséquences graves, comme des blessures ou des dommages à l'équipement.

3.2 Terminal definition

Terminal number	Definition	Description
1	AI0	Current input CH0
2	GND	
3	AI1	Current input CH1
4	GND	
5	AI2	Current input CH2
6	GND	
7	AI3	Current input CH3
8	GND	
9	NC	Not connected

WARNING

UNEXPECTED EQUIPMENT OPERATION

Calculate the maximum field power current consumption of a single module based on the actual field load. If the total field power current consumption of all I/O modules exceeds the power supply capacity of the field power supply, you must add an extra power expansion module. Otherwise, an output channel exception may occur.

Failure to follow instructions specified by the manufacturer may result in serious consequences such as death, personal injury, or damage to equipment since the protection provided by the equipment may be impaired.

AVERTISSEMENT

FONCTIONNEMENT INATTENDU DE L'EQUIPEMENT

Calculez la consommation maximale de courant de champ d'un seul module en fonction de la charge de champ réelle. Si la consommation totale de courant de champ de tous les modules d'E/S dépasse la capacité d'alimentation de l'alimentation de champ, vous devez ajouter un module d'extension de puissance supplémentaire. Dans le cas contraire, une exception de canal de sortie peut se produire.

Le fait de ne pas suivre les instructions peut entraîner une défaillance de la protection fournie par l'équipement, ce qui peut entraîner des conséquences graves, comme des blessures ou des dommages à l'équipement.

When connecting a cold-pressed terminal, the terminal must be terminated and checked in strict accordance with the corresponding termination specifications or requirements, and connect the cold-pressed terminal according to the corresponding

node serial number. The conductor should use copper conductor and the conductor core should be larger than 0.2mm^2 and smaller than 1mm^2 (AWG18~AWG24). Cold-pressed terminal parameters are as follows:

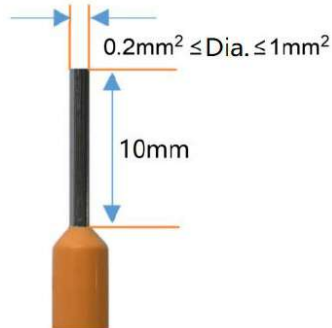

! WARNING

UNEXPECTED EQUIPMENT OPERATION

Strip the length of the conductor insulation layer is greater than 10mm to ensure reliable signal connection.

The wire needs to use copper wire and the wire core is greater than or equal to 0.2mm^2 and less than or equal to 1mm^2 to ensure reliable signal connection.

When connecting a cold-press terminal, connect the cold-press terminal strictly in accordance with the corresponding termination specifications or requirements, and connect the cold-press terminal according to the corresponding node serial number.

Do not power on cold-press terminals until they are properly connected or fully locked.

Failure to follow instructions specified by the manufacturer may result in serious consequences such as death, personal injury, or damage to equipment since the protection provided by the equipment may be impaired.

! AVERTISSEMENT

FONCTIONNEMENT INATTENDU DE L'EQUIPEMENT

Dépouillez la longueur de la couche isolante du fil plus de 10mm pour assurer la connexion fiable du signal.

Le conducteur doit utiliser le fil de cuivre et le noyau de fil est supérieur ou égal à $0,2\text{ mm}^2$, inférieur ou égal à 1mm^2 , afin d'assurer la connexion fiable du signal.

Lorsque les terminaux de presse à froid sont terminés, ils doivent être terminés et visualisés en stricte conformité avec les spécifications ou les exigences correspondantes et terminés selon le numéro de série de noeud correspondant.

Il est interdit d'activer les bornes à froid avant qu'elles ne soient correctement articulées ou complètement verrouillées.

Le fait de ne pas suivre les instructions peut entraîner une défaillance de la protection

fournie par l'équipement, ce qui peut entraîner des conséquences graves, comme des blessures ou des dommages à l'équipement.

DANGER

FIRE DANGER

Use the correct wiring rules only for the maximum current capacity of the I/O channel and power supply.

Failure to follow instructions specified by the manufacturer may result in serious consequences such as death, personal injury, or damage to equipment since the protection provided by the equipment may be impaired.

WARNING

UNEXPECTED EQUIPMENT OPERATION

Do not exceed any of the ratings specified in the environmental and electrical characteristics table.

Failure to follow instructions specified by the manufacturer may result in serious consequences such as death, personal injury, or damage to equipment since the protection provided by the equipment may be impaired.

AVERTISSEMENT

FONCTIONNEMENT INATTENDU DE L'EQUIPEMENT

Ne dépassez aucune évaluation spécifiée dans le tableau de caractéristiques environnementales et électriques..

Le fait de ne pas suivre les instructions peut entraîner une défaillance de la protection fournie par l'équipement, ce qui peut entraîner des conséquences graves, comme des blessures ou des dommages à l'équipement.

4 Wiring

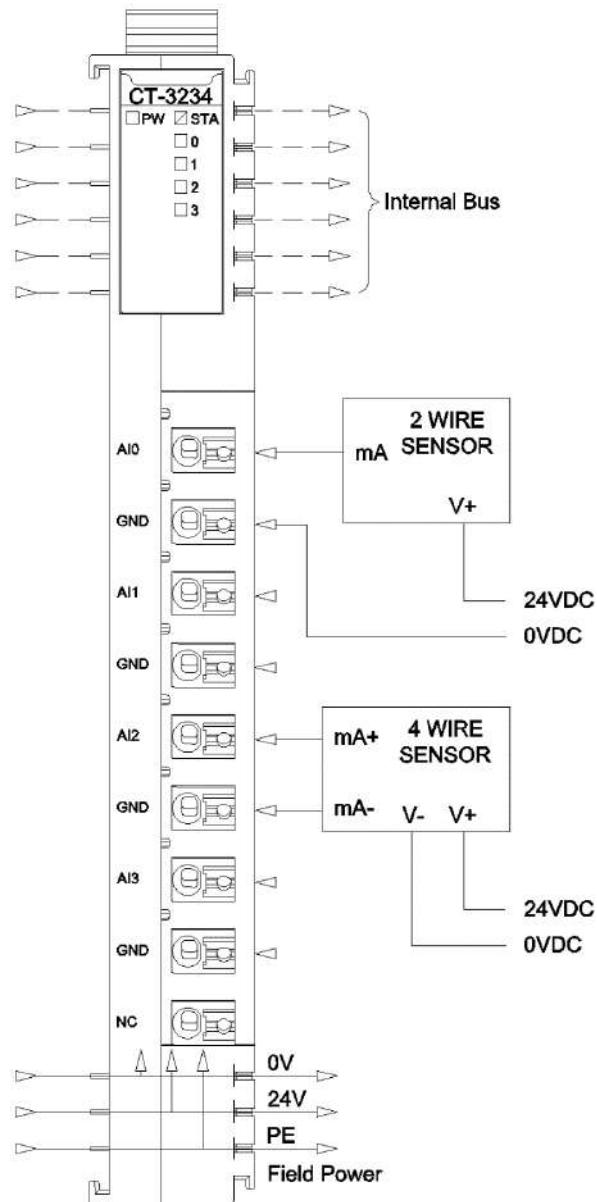

NOTICE

EQUIPMENT INOPERABLE

Do not crimp the spring terminal with more than the maximum pressure specified for the terminal. Otherwise, the resilience of the spring terminal may be damaged and the terminal rebound may be affected.

Do not press the spring terminal with a sharp tool when removing cable from the channel. Otherwise, the spring terminal will be damaged.

Failure to follow these instructions may result in equipment damage.

 **WARNING**

UNEXPECTED EQUIPMENT OPERATION

Do not link wires to unused terminals and/or terminals marked "NO CONNECTION (NC)"
Failure to follow instructions specified by the manufacturer may result in serious consequences such as death, personal injury, or damage to equipment since the protection provided by the equipment may be impaired.

 **AVERTISSEMENT**

FONCTIONNEMENT INATTENDU DE L'EQUIPEMENT

Ne reliez pas les fils aux terminaux inutilisés et/ou aux terminaux marqués «NO CONNECTION (NC)»

Le fait de ne pas suivre les instructions peut entraîner une défaillance de la protection fournie par l'équipement, ce qui peut entraîner des conséquences graves, comme des blessures ou des dommages à l'équipement.

5 Process data definition

Input data								
Bit No	Bit 7	Bit 6	Bit 5	Bit 4	Bit 3	Bit 2	Bit 1	Bit 0
Byte 0	Analog Input Data (CH 0)							
Byte 1								
Byte 2	Analog Input Data (CH 1)							
Byte 3								
Byte 4	Analog Input Data (CH 2)							
Byte 5								
Byte 6	Analog Input Data (CH 3)							
Byte 7								

Data description :

Analog Input Data (CH0-3): Analog signal Input value of corresponding channel.

Analog Input Data (CT-3234)				
Current (0-20mA)	Current (4-20mA)	Decimal	Hexadecimal	Location
>23.515	>22.810	32767	7FFF	Overflow
23.515	22.81	32511	7EFF	Exceed the upper limit
.	.	.	.	
.	.	.	.	
20.0007	20.0005	27649	6C01	
20	20	27648	6C00	Rated range
.	.	.	.	
.	.	.	.	
0	4	0	0000	
<0.0	3.9995	-1	FFFF	Exceed the lower limit
.	.	.	.	
.	.	.	.	
.	1.1852	-4864	ED00	
.	<1.1852	-32767	7FFF	Channel disabled
.	<1.1852	-32768	8000	Underflow

Note: ADC chip fault process data is 32765, disable channel upload process data is -

32767

6 Configuration parameter definition

Configuration parameters								
Bit No	Bit 7	Bit 6	Bit 5	Bit 4	Bit 3	Bit 2	Bit 1	Bit 0
Byte 0	Reserved							16Bit Data Format
Byte 1	Reserved				Channel Enable Ch#3	Channel Enable Ch#2	Channel Enable Ch#1	Channel Enable Ch#0
Byte 2	Reserved				Current Type Ch#3	Current Type Ch#2	Current Type Ch#1	Current Type Ch#0
Byte 3	Ch#0 Filter Level							
Byte 4	Ch#1 Filter Level							
Byte 5	Ch#2 Filter Level							
Byte 6	Ch#3 Filter Level							
Byte 7 ... Byte 10	Reserved							

Data description:

16Bit Data Format: Analog data storage format (default: 0).

0: A-B

1: B-A

Channel Enable Ch#(0-3): Type of channel enable (default: 1).

0: Disable

1: Enable

Current Type Ch#(0-3): Type of input signal (default: 1).

0: 0-20mA

1: 4-20mA

Filter Level Ch#(0-3): Filter level (default: 0).

0: level 0

1: level 1

2: level 2

- 3: level 3
- 4: level 4
- 5: level 5
- 6: level 6
- 7: level 7
- 8: level 8
- 9: level 9
- 10: level 10

 **WARNING**

UNEXPECTED EQUIPMENT OPERATION

The filtering parameters could be adjusted according to the field conditions. If the parameter settings are inappropriate, the signal will be lost.

Input current type parameters can be adjusted according to the site conditions. If the parameter Settings are inappropriate, signal loss will occur.

Failure to follow instructions specified by the manufacturer may result in serious consequences such as death, personal injury, or damage to equipment since the protection provided by the equipment may be impaired.

 **AVERTISSEMENT**

FONCTIONNEMENT INATTENDU DE L'EQUIPEMENT

Les paramètres de filtrage peuvent être ajustés en fonction des conditions du site. Si les paramètres ne sont pas réglés correctement, la perte de signal se produira.

Les paramètres de type courant d'entrée peuvent être ajustés en fonction des conditions du site. Si les paramètres sont inappropriés, une perte de signal se produira.

Le fait de ne pas suivre les instructions peut entraîner une défaillance de la protection fournie par l'équipement, ce qui peut entraîner des conséquences graves, comme des blessures ou des dommages à l'équipement.

A Dimension drawing

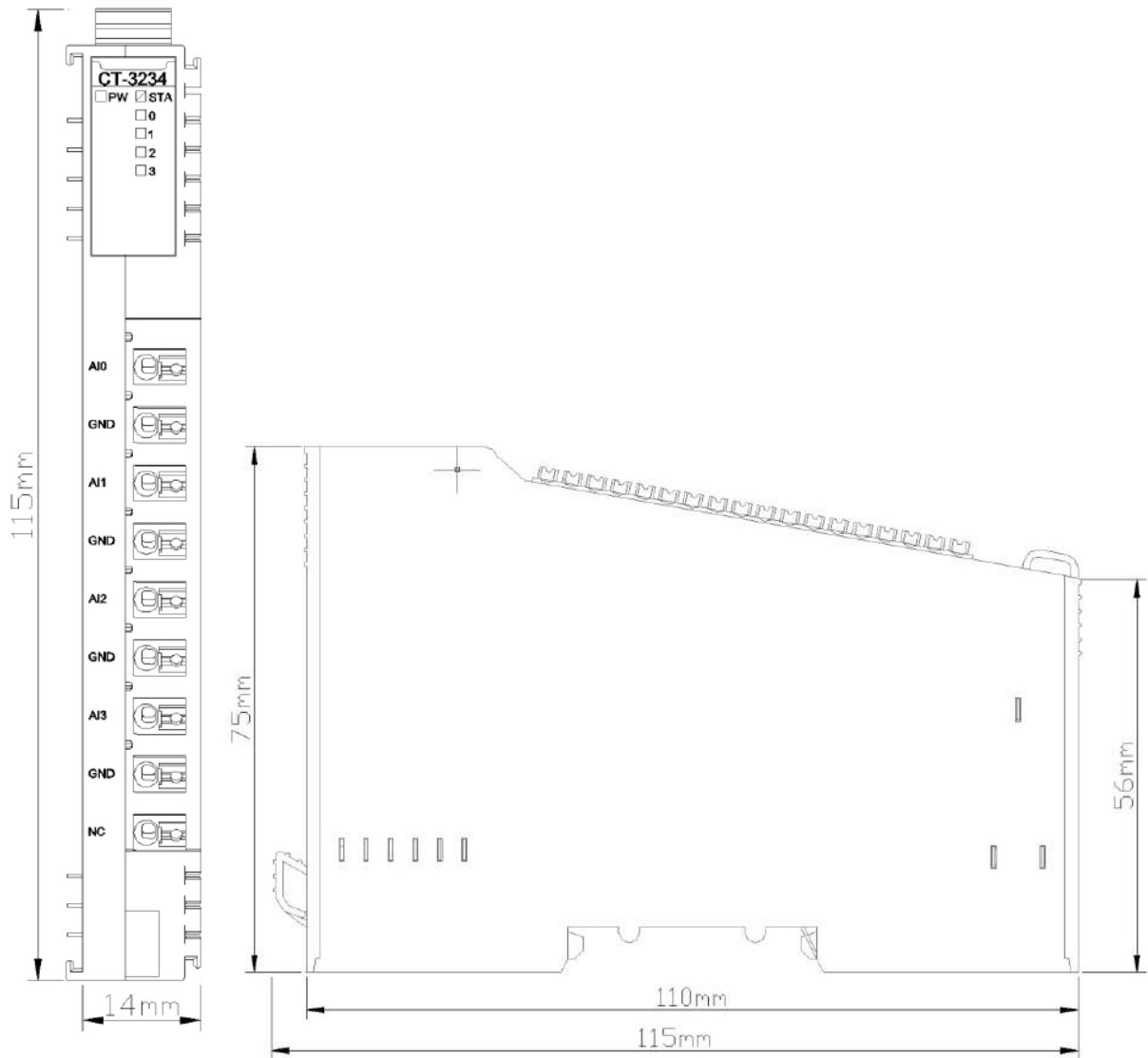

CT-3238: 8 channels analog input /0&4-20mA/15-bit single-terminal

1 Module features

- ◆ The module supports 8-channel current signal acquisition.
- ◆ The module can be configured for 0-20mA or 4-20mA current signal acquisition.
- ◆ The module supports 2-wire (non-loop output, external power supply is required) or 4-wire current sensor input.
- ◆ The internal bus of the module and field input adopts magnetic insulation.
- ◆ The module input channel is connected to the field active analog signal current output sensor.
- ◆ The module channel equips with TVS overvoltage protection.

2 Technical parameters

General Parameters	
Power	Max.65mA@5.0VDC
Isolation	I/O to internal bus: magnetic isolation (2.5KVrms) Power isolation: DC-DC
Wiring	Max.: AWG 18 Min.: AWG 24
Installation	35mm DIN-Rail
Size	115*14*75mm
Weight	65g
Vibration Resistance	Comply with IEC 61131-2 and EC 60068-2-6
Impact resistance	Comply with IEC 61131-2 and IEC 60068-2-27
EMC Performance	Comply with IEC 61131-2 and IEC 61000-4
Environmental parameters	
Operating Temperature of Horizontal Installation	-35°C~70°C
Operating Temperature of Vertical Installation	-35°C~60°C
Relative Humidity	< 95%RH (No Condensation)
Storage Temperature	-40°C~85°C
Storage Humidity	< 95%RH (No Condensation)
Manufacturing Test Temperature	-40°C~75°C
Ingress Protection Rating	IP20
Input Parameters	
Channel Number	8 channels
LED Indicator	8 LED channel state indicators
Input range	Maximum: 0 ~ 23.5 mA
Resolution Ratio	15 Bit
Acquisition Precision	±0.3% full range, @25°C
	±0.5% full range, @-20~70°C
Sampling Rate	28 ms / 8 channels
Data Format	16-bit signed integer

 **WARNING**

UNEXPECTED EQUIPMENT OPERATION

Do not exceed any of the ratings specified in the environmental and electrical characteristics table.

Failure to follow instructions specified by the manufacturer may result in serious consequences such as death, personal injury, or damage to equipment since the protection provided by the equipment may be impaired.

 **AVERTISSEMENT**

FONCTIONNEMENT INATTENDU DE L'EQUIPEMENT

Ne dépassez aucune évaluation spécifiée dans le tableau de caractéristiques environnementales et électriques.

Le fait de ne pas suivre les instructions peut entraîner une défaillance de la protection fournie par l'équipement, ce qui peut entraîner des conséquences graves, comme des blessures ou des dommages à l'équipement.

3 Hardware interfaces

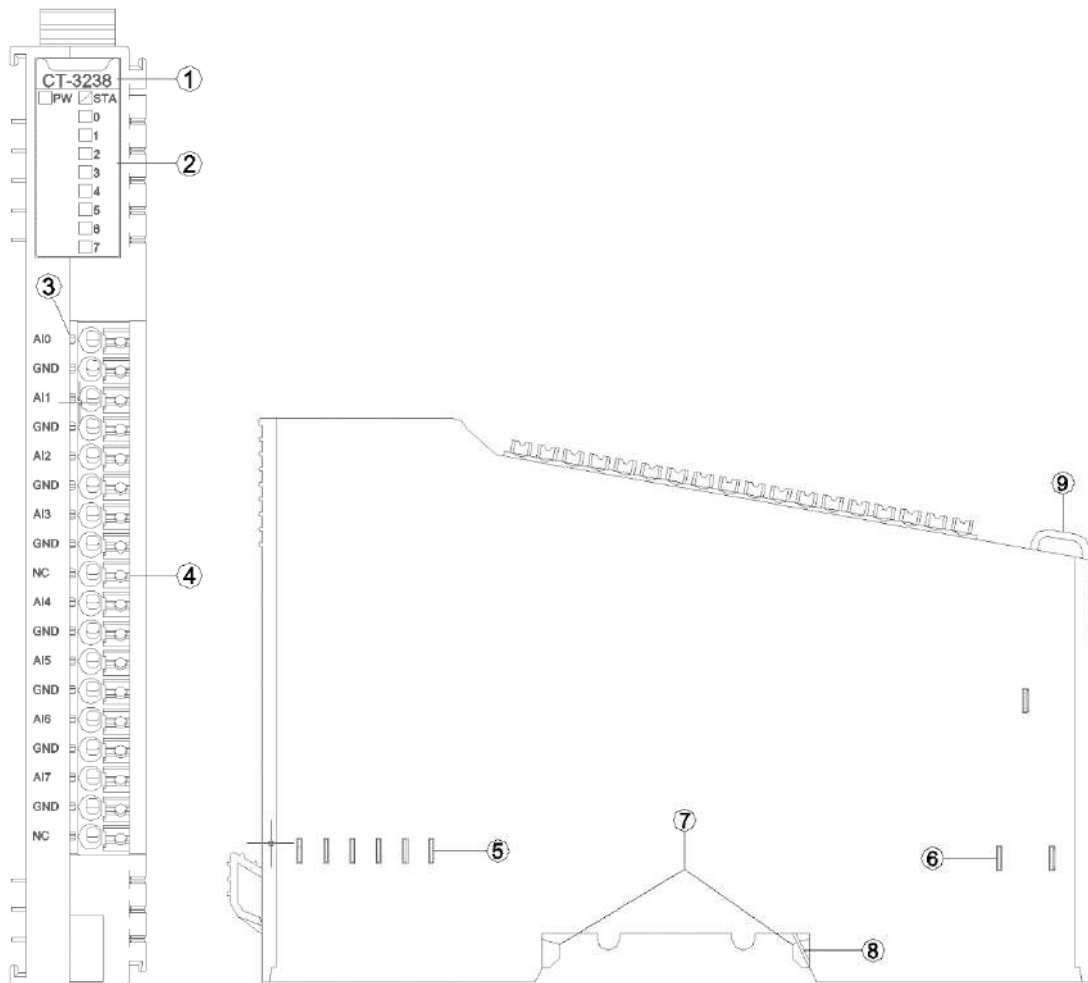

- ① Module Type
- ② State indicator
- ③ N/A
- ④ Wiring Terminal and identification
- ⑤ Internal Bus
- ⑥ Field Power
- ⑦ Buckle
- ⑧ Grounding Spring Sheet
- ⑨ Fixed Wiring Harness

3.1 LED indicator lights

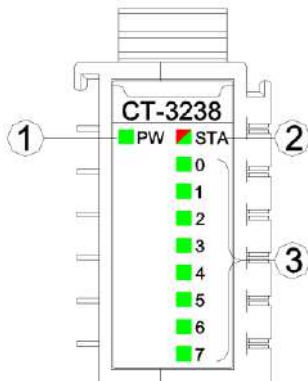

- ① Power indicator light (green)
- ② Module State indicator (red/green)
- ③ Input channel indicator light (green)

PW power indicator	Definition
ON	Internal bus power supply is normal
OFF	Internal bus power supply is failure
STA module State indicator	Definition
Green slow flash (2.5hz)	The internal bus of the module is not started
Red slow flash (2.5hz)	Module internal bus offline
Green on	Operation normal
Flash(2.5Hz) (RED/GREEN)	Upgrading mode
Flash(10Hz) (RED/GREEN)	Firmware upgrading
Red flashes twice	Module exception has been soft-restarted
0-7 channel indicator light	Definition
ON	Input signal $\geq 1\%$ range
OFF	Input signal $< 1\%$ range

⚠ WARNING

UNEXPECTED EQUIPMENT OPERATION

By viewing the PW indicator, could determine the power supply status of a module. If the PW is steady green, the power supply is normal. Otherwise, the module cannot work properly.

When the module is initially powered on, there will be 3S for the backplane bus connection. After the backplane bus is initialized, STA is in the green steady state. If STA is in the green blinking state, it indicates that the backplane bus has not been initialized, and it needs to be powered off and restarted for re-initialization.

STA abnormal working state occurs during the normal operation of the module, please check the firmware version information of all modules, and consult ODOT technical support for details.

If a module is upgraded, check that all modules are in the normal state after the upgrade. Otherwise, an exception may occur.

Failure to follow instructions specified by the manufacturer may result in serious consequences such as death, personal injury, or damage to equipment since the protection provided by the equipment may be impaired.

AVERTISSEMENT

FONCTIONNEMENT INATTENDU DE L'EQUIPEMENT

En regardant l'état de l'indicateur de PW, jugez l'état d'alimentation du module. Le feu vert PW reste allumé et l'alimentation est normale. Autrement, le module ne fonctionnera pas correctement.

Lorsque le module est alimenté initialement, il y aura 3S pour la connexion de bus de backboard. STA est un état vert permanent après l'initialisation du bus de backboard. Si STA est en état de clignotement vert, cela signifie que l'initialisation du bus de backboard n'est pas passée et doit être redémarrée hors tension et réinitialisée.

L'état de fonctionnement anormal de STA se produit pendant le fonctionnement normal du module, veuillez vérifier les informations de version du firmware de tous les modules, et consulter le support technique ODOT pour plus de détails.

Si le module a une opération de mise à niveau, après l'achèvement de la mise à niveau, le besoin de vérifier que tous les modules sont dans l'état normal avant de courir, sinon il conduira à une exception.

Le fait de ne pas suivre les instructions peut entraîner une défaillance de la protection fournie par l'équipement, ce qui peut entraîner des conséquences graves, comme des blessures ou des dommages à l'équipement.

3.2 Terminal definition

Terminal number	Definition	Description
1	AI0	Current input CH0
2	GND	
3	AI1	Current input CH1
4	GND	
5	AI2	Current input CH2
6	GND	
7	AI3	Current input CH3
8	GND	
9	NC	Not connected
10	AI4	Current input CH4
11	GND	
12	AI5	Current input CH5
13	GND	
14	AI6	Current input CH6
15	GND	
16	AI7	Current input CH7
17	GND	
18	NC	Not connected

WARNING

UNEXPECTED EQUIPMENT OPERATION

Calculate the maximum field power current consumption of a single module based on the actual field load. If the total field power current consumption of all I/O modules exceeds the power supply capacity of the field power supply, you must add an extra power expansion module. Otherwise, an output channel exception may occur.

Failure to follow instructions specified by the manufacturer may result in serious consequences such as death, personal injury, or damage to equipment since the protection provided by the equipment may be impaired.

AVERTISSEMENT

FONCTIONNEMENT INATTENDU DE L'EQUIPEMENT

Calculez la consommation maximale de courant de champ d'un seul module en fonction de la charge de champ réelle. Si la consommation totale de courant de champ de tous les modules d'E/S dépasse la capacité d'alimentation de l'alimentation de champ, vous devez ajouter un module d'extension de puissance supplémentaire. Dans le cas contraire, une exception de canal de sortie peut se produire.

Le fait de ne pas suivre les instructions peut entraîner une défaillance de la protection fournie

par l'équipement, ce qui peut entraîner des conséquences graves, comme des blessures ou des dommages à l'équipement.

When connecting a cold-pressed terminal, the terminal must be terminated and checked in strict accordance with the corresponding termination specifications or requirements, and connect the cold-pressed terminal according to the corresponding node serial number. The conductor should use copper conductor and the conductor core should be larger than 0.2mm^2 and smaller than 1mm^2 (AWG18~AWG24). Cold-pressed terminal parameters are as follows:

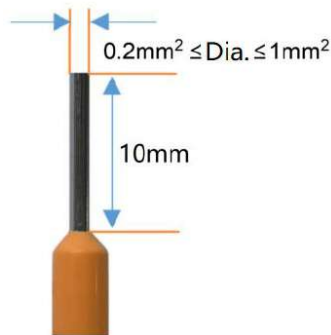

⚠ WARNING

UNEXPECTED EQUIPMENT OPERATION

Strip the length of the conductor insulation layer is greater than 10mm to ensure reliable signal connection.

The wire needs to use copper wire and the wire core is greater than or equal to 0.2mm^2 and less than or equal to 1mm^2 to ensure reliable signal connection.

When connecting a cold-press terminal, connect the cold-press terminal strictly in accordance with the corresponding termination specifications or requirements, and connect the cold-press terminal according to the corresponding node serial number.

Do not power on cold-press terminals until they are properly connected or fully locked.

Failure to follow instructions specified by the manufacturer may result in serious consequences such as death, personal injury, or damage to equipment since the protection provided by the equipment may be impaired.

⚠ AVERTISSEMENT

FONCTIONNEMENT INATTENDU DE L'EQUIPEMENT

Dépouillez la longueur de la couche isolante du fil plus de 10mm pour assurer la connexion fiable du signal.

Le conducteur doit utiliser le fil de cuivre et le noyau de fil est supérieur ou égal à 0,2 mm², inférieur ou égal à 1mm², afin d'assurer la connexion fiable du signal.

Lorsque les terminaux de presse à froid sont terminés, ils doivent être terminés et visualisés en stricte conformité avec les spécifications ou les exigences correspondantes et terminés selon le numéro de série de noeud correspondant.

Il est interdit d'activer les bornes à froid avant qu'elles ne soient correctement articulées ou complètement verrouillées.

Le fait de ne pas suivre les instructions peut entraîner une défaillance de la protection fournie par l'équipement, ce qui peut entraîner des conséquences graves, comme des blessures ou des dommages à l'équipement.

DANGER

FIRE DANGER

Use the correct wiring rules only for the maximum current capacity of the I/O channel and power supply.

Failure to follow instructions specified by the manufacturer may result in serious consequences such as death, personal injury, or damage to equipment since the protection provided by the equipment may be impaired.

WARNING

UNEXPECTED EQUIPMENT OPERATION

Do not exceed any of the ratings specified in the environmental and electrical characteristics table.

Failure to follow instructions specified by the manufacturer may result in serious consequences such as death, personal injury, or damage to equipment since the protection provided by the equipment may be impaired.

AVERTISSEMENT

FONCTIONNEMENT INATTENDU DE L'EQUIPEMENT

Ne dépassez aucune évaluation spécifiée dans le tableau de caractéristiques environnementales et électriques..

Le fait de ne pas suivre les instructions peut entraîner une défaillance de la protection fournie par l'équipement, ce qui peut entraîner des conséquences graves, comme des blessures ou des dommages à l'équipement.

4 Wiring

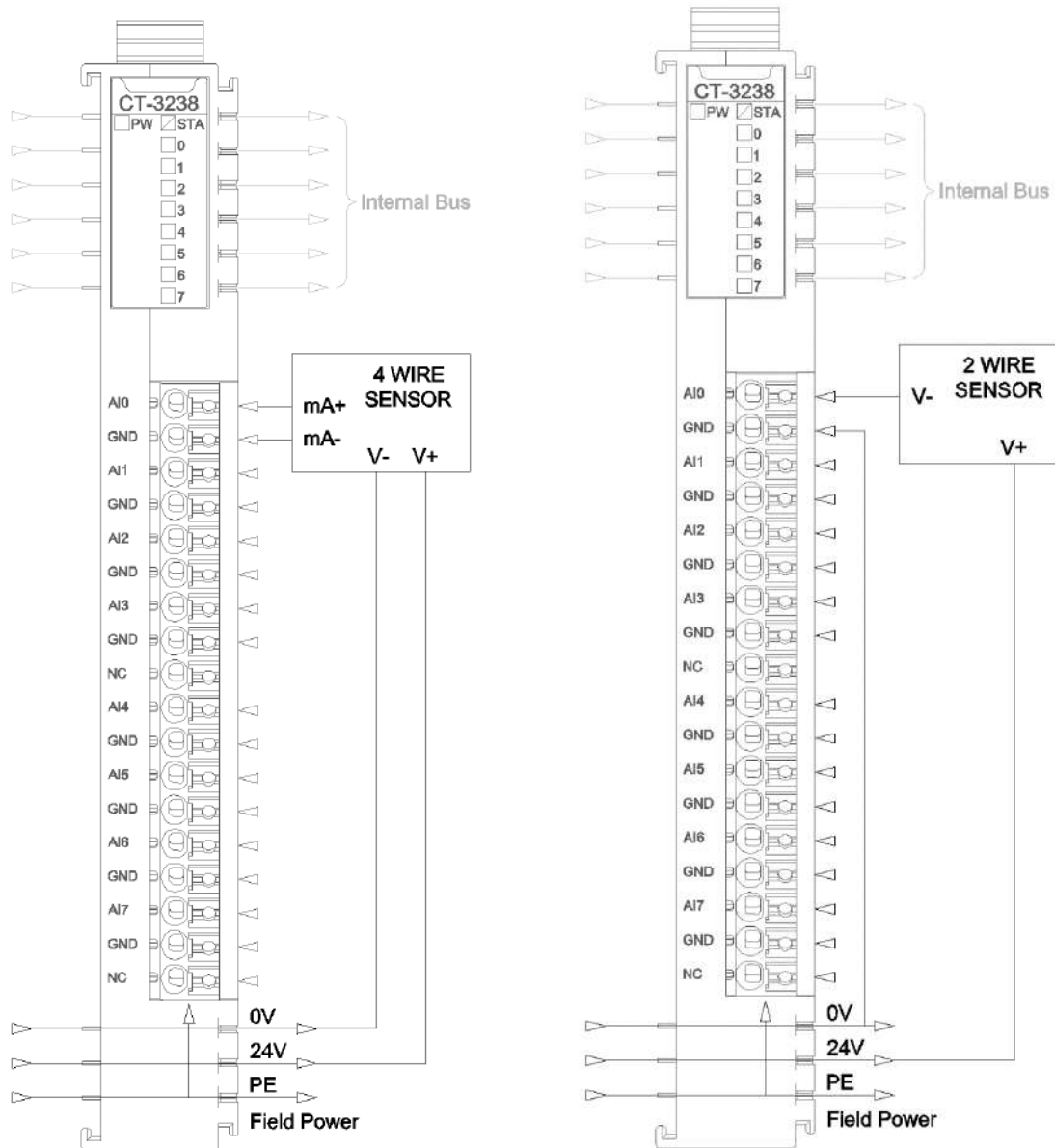

NOTICE

EQUIPMENT INOPERABLE

Do not crimp the spring terminal with more than the maximum pressure specified for the terminal. Otherwise, the resilience of the spring terminal may be damaged and the terminal rebound may be affected.

Do not press the spring terminal with a sharp tool when removing cable from the channel. Otherwise, the spring terminal will be damaged.

Failure to follow these instructions may result in equipment damage.

 **WARNING**

UNEXPECTED EQUIPMENT OPERATION

Do not link wires to unused terminals and/or terminals marked "NO CONNECTION (NC)"
Failure to follow instructions specified by the manufacturer may result in serious consequences such as death, personal injury, or damage to equipment since the protection provided by the equipment may be impaired.

 **AVERTISSEMENT**

FONCTIONNEMENT INATTENDU DE L'EQUIPEMENT

Ne reliez pas les fils aux terminaux inutilisés et/ou aux terminaux marqués «NO CONNECTION (NC)»

Le fait de ne pas suivre les instructions peut entraîner une défaillance de la protection fournie par l'équipement, ce qui peut entraîner des conséquences graves, comme des blessures ou des dommages à l'équipement.

5 Process data definition

Input data								
Bit No	Bit 7	Bit 6	Bit 5	Bit 4	Bit 3	Bit 2	Bit 1	Bit 0
Byte 0	Analog Input Data (CH 0)							
Byte 1								
Byte 2	Analog Input Data (CH 1)							
Byte 3								
Byte 4	Analog Input Data (CH 2)							
Byte 5								
Byte 6	Analog Input Data (CH 3)							
Byte 7								
Byte 8	Analog Input Data (CH 4)							
Byte 9								
Byte 10	Analog Input Data (CH 5)							
Byte 11								
Byte 12	Analog Input Data (CH 6)							
Byte 13								
Byte 14	Analog Input Data (CH 7)							
Byte 15								

Data description:

Analog Input Data (CH0-7): Analog signal Input value of corresponding channel.

Analog Input Data (CT-3238)				
Current (0-20mA)	Current (4-20mA)	Decimal	Hexadecimal	Location
>23.515	>22.810	32767	7FFF	Overflow
23.515	22.81	32511	7EFF	Exceed the upper limit
.	.	.	.	
.	.	.	.	
20.0007	20.0005	27649	6C01	
20	20	27648	6C00	Rated range
.	.	.	.	
.	.	.	.	
0	4	0	0000	
<0.0	3.9995	-1	FFFF	Exceed the lower limit
.	.	.	.	
.	.	.	.	
.	1.1852	-4864	ED00	
.	<1.1852	-32767	7FFF	Channel disabled
.	<1.1852	-32768	8000	Underflow

Note: ADC chip fault process data is 32765, disable channel upload process data is - 32767

For example: AI0 input monitoring value of the CT-3238 is 16#3126=12582, if it chooses the range of 4-20mA, then the theoretical input value of AI0 is: $12582/27648*16+4=11.28125\text{mA}$.

For example: AI0 input monitoring value of the CT-3238 is 16#3126=12582, if it chooses the range of 0-20mA, then the theoretical input value of AI0 is: $12582/27648*20=9.10156\text{mA}$

6 Configuration parameter definition

Configuration parameter								
Bit No	Bit 7	Bit 6	Bit 5	Bit 4	Bit 3	Bit 2	Bit 1	Bit 0
Byte 0	Reserved							16Bit Data Format
Byte 1	Channel Enable Ch#7	Channel Enable Ch#6	Channel Enable Ch#5	Channel Enable Ch#4	Channel Enable Ch#3	Channel Enable Ch#2	Channel Enable Ch#1	Channel Enable Ch#0
Byte 2	Current Type Ch#7	Current Type Ch#6	Current Type Ch#5	Current Type Ch#4	Current Type Ch#3	Current Type Ch#2	Current Type Ch#1	Current Type Ch#0
Byte 3	Ch#0 Filter Level							
Byte 4	Ch#1 Filter Level							
Byte 5	Ch#2 Filter Level							
Byte 6	Ch#3 Filter Level							
Byte 7	Ch#4 Filter Level							
Byte 8	Ch#5 Filter Level							
Byte 9	Ch#6 Filter Level							
Byte 10	Ch#7 Filter Level							

Data description:

16Bit Data Format: Analog data storage format (default: 0).

0: A-B

1: B-A

Channel Enable Ch#(0-7): Type of channel enable (default: 1).

0: Disable

1: Enable

Current Type Ch#(0-7): Type of input signal (default: 1).

0: 0-20mA

1: 4-20mA

Filter Level Ch#(0-7): Filter level (default: 0).

0: level 0

- 1: level 1
- 2: level 2
- 3: level 3
- 4: level 4
- 5: level 5
- 6: level 6
- 7: level 7
- 8: level 8
- 9: level 9
- 10: level 10

 **WARNING**

UNEXPECTED EQUIPMENT OPERATION

The filtering parameters could be adjusted according to the field conditions. If the parameter settings are inappropriate, the signal will be lost.

Input current type parameters can be adjusted according to the site conditions. If the parameter Settings are inappropriate, signal loss will occur.

Failure to follow instructions specified by the manufacturer may result in serious consequences such as death, personal injury, or damage to equipment since the protection provided by the equipment may be impaired.

 **AVERTISSEMENT**

FONCTIONNEMENT INATTENDU DE L'EQUIPEMENT

Les paramètres de filtrage peuvent être ajustés en fonction des conditions du site. Si les paramètres ne sont pas réglés correctement, la perte de signal se produira.

Les paramètres de type courant d'entrée peuvent être ajustés en fonction des conditions du site. Si les paramètres sont inappropriés, une perte de signal se produira.

Le fait de ne pas suivre les instructions peut entraîner une défaillance de la protection fournie par l'équipement, ce qui peut entraîner des conséquences graves, comme des blessures ou des dommages à l'équipement.

A Dimension drawing

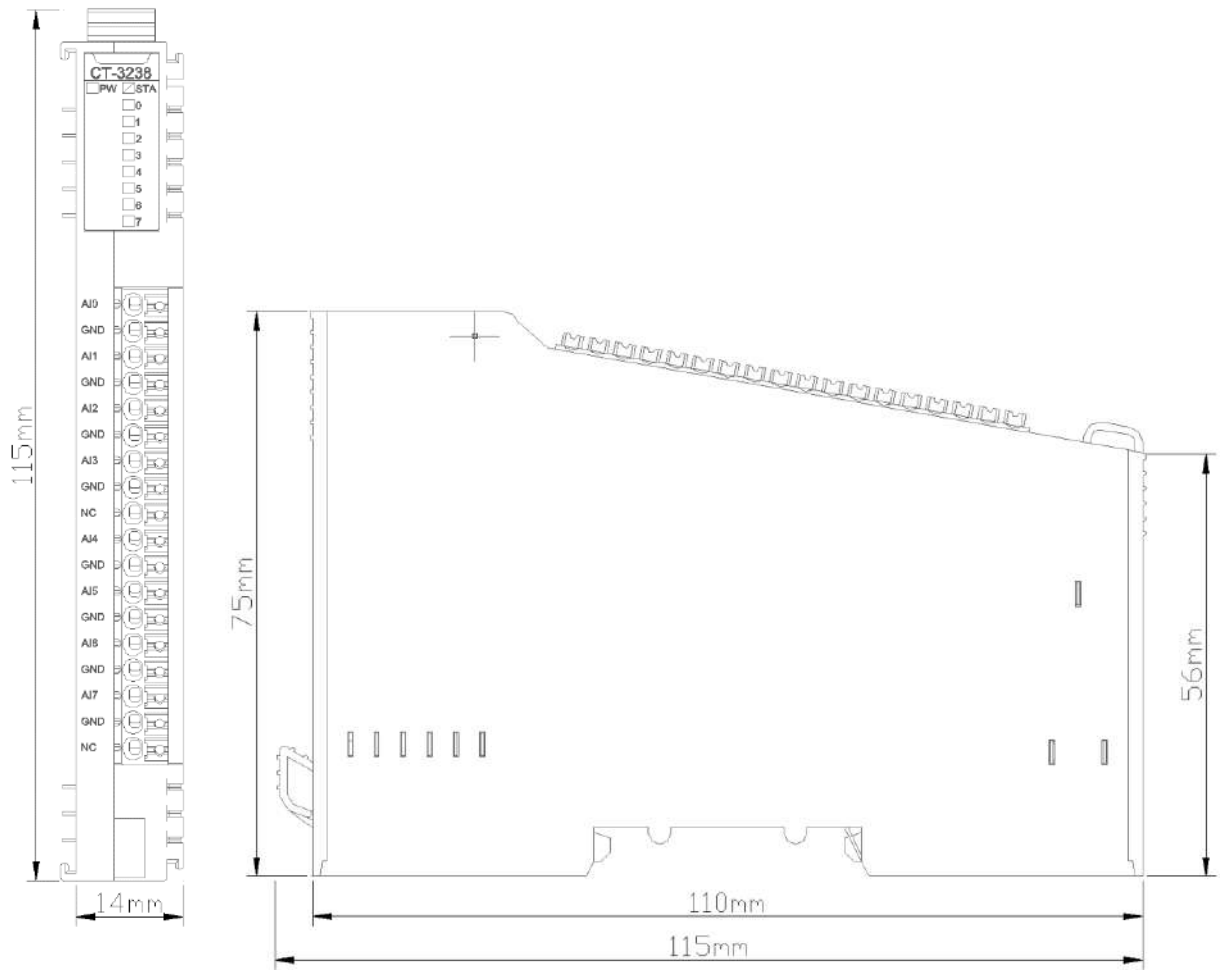

CT-3258 8 channels analog input /0 ~ 20mA OR -20~0mA OR ±20mA /12bit Single-ended bipolar

1 Module features

- ◆ The module supports 8-channel current signal acquisition.
- ◆ The module can be configured for 0~20mA or -20~0mA or ±20mA current signal acquisition.
- ◆ The module supports 2-wire (non-loop output, external power supply is required)
- ◆ The internal bus of the module and field input adopts magnetic insulation.
- ◆ The module input channel is to be connected to the field active analog signal current output sensor.
- ◆ The module channel equips with TVS overvoltage protection.

2 Technical parameters

General Parameters	
Power	Max.500mA@5.0VDC
Isolation	I/O to internal bus: magnetic isolation (2.5KVrms) Power isolation: DC-DC
Wiring	Max.: AWG 18 Min.: AWG 24
Installation	35mm DIN-Rail
Size	115*14*75mm
Weight	65g
Environmental parameters	
Operating Temperature of Horizontal Installation	-35°C~70°C
Operating Temperature of Vertical Installation	-35°C~60°C
Relative Humidity	< 95%RH (No Condensation)
Storage Temperature	-40°C~85°C
Storage Humidity	< 95%RH (No Condensation)
Manufacturing Test Temperature	-40°C~75°C
Ingress Protection Rating	IP20
Input Parameters	
Channel Number	8 channels
LED Indicator	8 LED channel state indicators
Input Range	Maximum: 0~24mA
Resolution Ratio	12 Bit
Acquisition Precision	±0.3% full range, @25°C
	±0.5% full range, @-20~70°C
Sampling Rate	28ms/8 channels
Data Format	16-bit signed integer

WARNING

UNEXPECTED EQUIPMENT OPERATION

Do not exceed any of the ratings specified in the environmental and electrical characteristics table.

Failure to follow instructions specified by the manufacturer may result in serious consequences such as death, personal injury, or damage to equipment since the protection provided by the equipment may be impaired.

 **AVERTISSEMENT**

FONCTIONNEMENT INATTENDU DE L'EQUIPEMENT

Ne dépassez aucune évaluation spécifiée dans le tableau de caractéristiques environnementales et électriques.

Le fait de ne pas suivre les instructions peut entraîner une défaillance de la protection fournie par l'équipement, ce qui peut entraîner des conséquences graves, comme des blessures ou des dommages à l'équipement.

3 Hardware interfaces

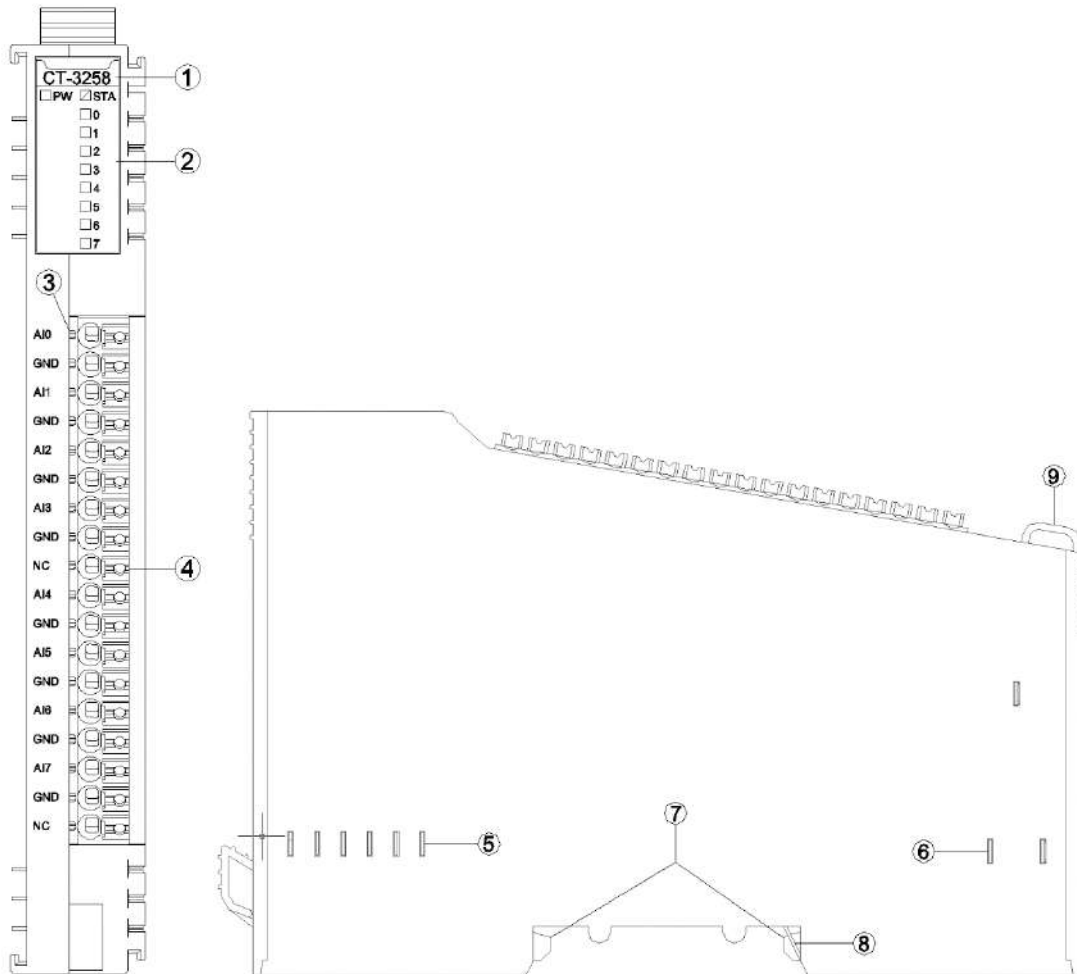

- ① Module Type
- ② State indicator
- ③ N/A
- ④ Wiring Terminal and marking
- ⑤ Internal Bus
- ⑥ Field Power
- ⑦ Buckle
- ⑧ Grounding Spring Sheet
- ⑨ Fixed Wiring Harness

3.1 LED indicator lights

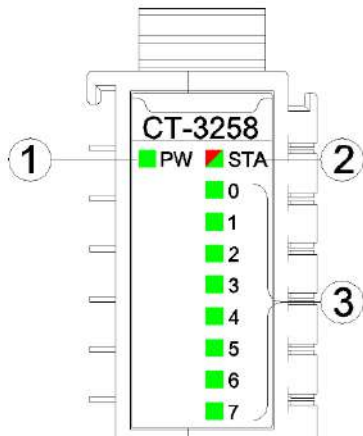

- ① Power indicator light (green)
- ② Module State indicator light (red/green)
- ③ Input channel indicator light (green)

PW power indicator	Definition
ON	Internal bus power supply is normal
OFF	Internal bus power supply is failure
STA module State indicator	Definition
Green slow flash (2.5hz)	The internal bus of the module is not started
Red slow flash (2.5hz)	Module internal bus offline
Green on	Operation normal
Flash(2.5Hz) (RED/GREEN)	Upgrading mode
Flash(10Hz) (RED/GREEN)	Firmware upgrading
Red flashes twice	Module exception has been soft-restarted
0-7 channel indicator light	Definition
ON	Input signal $\geq 1\%$ range
OFF	Input signal $< 1\%$ range

⚠ WARNING

UNEXPECTED EQUIPMENT OPERATION

By viewing the PW indicator, could determine the power supply status of a module. If the PW is steady green, the power supply is normal. Otherwise, the module cannot work properly.

When the module is initially powered on, there will be 3S for the backplane bus connection. After the backplane bus is initialized, STA is in the green steady state. If STA is in the green blinking state, it indicates that the backplane bus has not been initialized, and it needs to be powered off and restarted for re-initialization.

STA abnormal working state occurs during the normal operation of the module, please check the

firmware version information of all modules, and consult ODOT technical support for details.
If a module is upgraded, check that all modules are in the normal state after the upgrade.
Otherwise, an exception may occur.

Failure to follow instructions specified by the manufacturer may result in serious consequences such as death, personal injury, or damage to equipment since the protection provided by the equipment may be impaired.

AVERTISSEMENT

FONCTIONNEMENT INATTENDU DE L'EQUIPEMENT

En regardant l'état de l'indicateur de PW, jugez l'état d'alimentation du module. Le feu vert PW reste allumé et l'alimentation est normale. Autrement, le module ne fonctionnera pas correctement.

Lorsque le module est alimenté initialement, il y aura 3S pour la connexion de bus de backboard. STA est un état vert permanent après l'initialisation du bus de backboard. Si STA est en état de clignotement vert, cela signifie que l'initialisation du bus de backboard n'est pas passée et doit être redémarrée hors tension et réinitialisée.

L'état de fonctionnement anormal de STA se produit pendant le fonctionnement normal du module, veuillez vérifier les informations de version du firmware de tous les modules, et consulter le support technique ODOT pour plus de détails.

Si le module a une opération de mise à niveau, après l'achèvement de la mise à niveau, le besoin de vérifier que tous les modules sont dans l'état normal avant de courir, sinon il conduira à une exception.

Le fait de ne pas suivre les instructions peut entraîner une défaillance de la protection fournie par l'équipement, ce qui peut entraîner des conséquences graves, comme des blessures ou des dommages à l'équipement.

3.2 Terminal definition

Terminal number	Definition	Description
1	AI0	Current input CH0
2	GND	
3	AI1	Current input CH1
4	GND	
5	AI2	Current input CH2
6	GND	
7	AI3	Current input CH3
8	GND	
9	NC	Not connected
10	AI4	Current input CH4
11	GND	
12	AI5	Current input CH5
13	GND	
14	AI6	Current input CH6
15	GND	
16	AI7	Current input CH7
17	GND	
18	NC	Not connected

WARNING

UNEXPECTED EQUIPMENT OPERATION

Calculate the maximum field power current consumption of a single module based on the actual field load. If the total field power current consumption of all I/O modules exceeds the power supply capacity of the field power supply, you must add an extra power expansion module. Otherwise, an output channel exception may occur.

Failure to follow instructions specified by the manufacturer may result in serious consequences such as death, personal injury, or damage to equipment since the protection provided by the equipment may be impaired.

AVERTISSEMENT

FONCTIONNEMENT INATTENDU DE L'EQUIPEMENT

Calculez la consommation maximale de courant de champ d'un seul module en fonction de la charge de champ réelle. Si la consommation totale de courant de champ de tous les modules d'E/S dépasse la capacité d'alimentation de l'alimentation de champ, vous devez ajouter un module d'extension de puissance supplémentaire. Dans le cas contraire, une exception de canal de sortie peut se produire.

Le fait de ne pas suivre les instructions peut entraîner une défaillance de la protection fournie

par l'équipement, ce qui peut entraîner des conséquences graves, comme des blessures ou des dommages à l'équipement.

When connecting a cold-pressed terminal, the terminal must be terminated and checked in strict accordance with the corresponding termination specifications or requirements, and connect the cold-pressed terminal according to the corresponding node serial number. The conductor should use copper conductor and the conductor core should be larger than 0.2mm² and smaller than 1mm² (AWG18~AWG24). Cold-pressed terminal parameters are as follows:

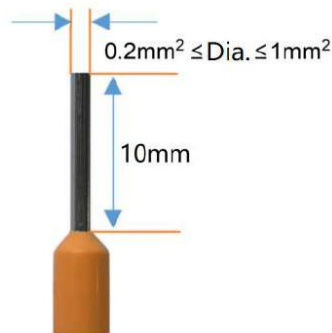

⚠ WARNING

UNEXPECTED EQUIPMENT OPERATION

Strip the length of the conductor insulation layer is greater than 10mm to ensure reliable signal connection.

The wire needs to use copper wire and the wire core is greater than or equal to 0.2mm² and less than or equal to 1mm² to ensure reliable signal connection.

When connecting a cold-press terminal, connect the cold-press terminal strictly in accordance with the corresponding termination specifications or requirements, and connect the cold-press terminal according to the corresponding node serial number.

Do not power on cold-press terminals until they are properly connected or fully locked.

Failure to follow instructions specified by the manufacturer may result in serious consequences such as death, personal injury, or damage to equipment since the protection provided by the equipment may be impaired.

⚠ AVERTISSEMENT

FONCTIONNEMENT INATTENDU DE L'EQUIPEMENT

Dépouillez la longueur de la couche isolante du fil plus de 10mm pour assurer la connexion fiable du signal.

Le conducteur doit utiliser le fil de cuivre et le noyau de fil est supérieur ou égal à 0,2 mm², inférieur ou égal à 1mm², afin d'assurer la connexion fiable du signal.

Lorsque les terminaux de presse à froid sont terminés, ils doivent être terminés et visualisés en stricte conformité avec les spécifications ou les exigences correspondantes et terminés selon le numéro de série de noeud correspondant.

Il est interdit d'activer les bornes à froid avant qu'elles ne soient correctement articulées ou complètement verrouillées.

Le fait de ne pas suivre les instructions peut entraîner une défaillance de la protection fournie par l'équipement, ce qui peut entraîner des conséquences graves, comme des blessures ou des dommages à l'équipement.

DANGER

FIRE DANGER

Use the correct wiring rules only for the maximum current capacity of the I/O channel and power supply.

Failure to follow instructions specified by the manufacturer may result in serious consequences such as death, personal injury, or damage to equipment since the protection provided by the equipment may be impaired.

WARNING

UNEXPECTED EQUIPMENT OPERATION

Do not exceed any of the ratings specified in the environmental and electrical characteristics table.

Failure to follow instructions specified by the manufacturer may result in serious consequences such as death, personal injury, or damage to equipment since the protection provided by the equipment may be impaired.

AVERTISSEMENT

FONCTIONNEMENT INATTENDU DE L'EQUIPEMENT

Ne dépassez aucune évaluation spécifiée dans le tableau de caractéristiques environnementales et électriques..

Le fait de ne pas suivre les instructions peut entraîner une défaillance de la protection fournie par l'équipement, ce qui peut entraîner des conséquences graves, comme des blessures ou des dommages à l'équipement.

4 Wiring

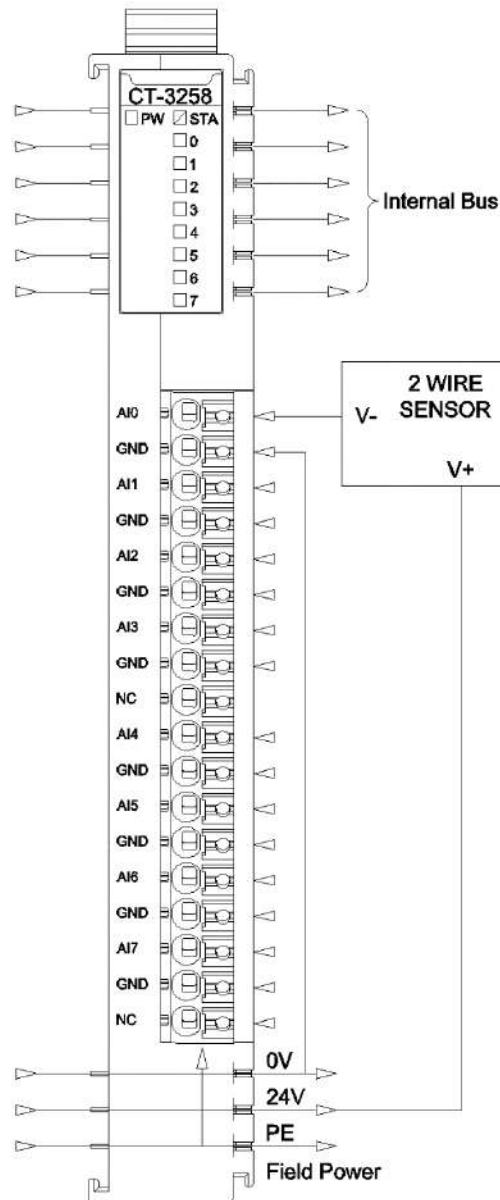

NOTICE

EQUIPMENT INOPERABLE

Do not crimp the spring terminal with more than the maximum pressure specified for the terminal. Otherwise, the resilience of the spring terminal may be damaged and the terminal rebound may be affected.

Do not press the spring terminal with a sharp tool when removing cable from the channel. Otherwise, the spring terminal will be damaged.

Failure to follow these instructions may result in equipment damage.

 **WARNING**

UNEXPECTED EQUIPMENT OPERATION

Do not link wires to unused terminals and/or terminals marked "NO CONNECTION (NC)"
Failure to follow instructions specified by the manufacturer may result in serious consequences such as death, personal injury, or damage to equipment since the protection provided by the equipment may be impaired.

 **AVERTISSEMENT**

FONCTIONNEMENT INATTENDU DE L'EQUIPEMENT

Ne reliez pas les fils aux terminaux inutilisés et/ou aux terminaux marqués «NO CONNECTION (NC)»

Le fait de ne pas suivre les instructions peut entraîner une défaillance de la protection fournie par l'équipement, ce qui peut entraîner des conséquences graves, comme des blessures ou des dommages à l'équipement.

5 Process data definition

Input data								
Bit No	Bit 7	Bit 6	Bit 5	Bit 4	Bit 3	Bit 2	Bit 1	Bit 0
Byte 0	Analog Input Data(CH 0)							
Byte 1								
Byte 2	Analog Input Data(CH 1)							
Byte 3								
Byte 4	Analog Input Data(CH 2)							
Byte 5								
Byte 6	Analog Input Data(CH 3)							
Byte 7								
Byte 8	Analog Input Data(CH 4)							
Byte 9								
Byte 10	Analog Input Data(CH 5)							
Byte 11								
Byte 12	Analog Input Data(CH 6)							
Byte 13								
Byte 14	Analog Input Data(CH 7)							
Byte 15								

Data description:

Analog Input Data (CH0-7): Analog signal Input value of corresponding channel.

Analog Input Data (CT-3258)				
Current (0-20mA)	Current (-20-0mA)	Current (± 20 mA)	Decimal	Hexadecimal
>24	>0	>24	32767	7FFF
24	.	24	4095	0FFF
.
20	.	20	3412	0D54
.
10	.	10	1706	06AA
.
0	0	0	0	0000
<0
.	-.10	-10	-1706	F956.
.
.	-.20	-20	-3412.	F2AC
.
.	-24	-24	-4095	F001
.	<-24	<-24	-32768	8000

6 Configuration parameter definition

Configuration parameters								
Bit No	Bit 7	Bit 6	Bit 5	Bit 4	Bit 3	Bit 2	Bit 1	Bit 0
Byte 0	16Bit Data Format							
Byte 1	Current Type Ch#7	Current Type Ch#6	Current Type Ch#5	Current Type Ch#4	Current Type Ch#3	Current Type Ch#2	Current Type Ch#1	Current Type Ch#0

Data description:

16Bit Data Format: Analog data storage format. (default: 0)

0: A-B

1: B-A

Current Type Ch#(0-7): Type of input signal. (default: 1)

0: N/A

1: 0~20mA

2: -20~0mA

3: ± 20 mA

WARNING

UNEXPECTED EQUIPMENT OPERATION

Input current type parameters can be adjusted according to the site conditions. If the parameter Settings are inappropriate, signal loss will occur.

Failure to follow instructions specified by the manufacturer may result in serious consequences such as death, personal injury, or damage to equipment since the protection provided by the equipment may be impaired.

AVERTISSEMENT

FONCTIONNEMENT INATTENDU DE L'EQUIPEMENT

Les paramètres de type courant d'entrée peuvent être ajustés en fonction des conditions du site. Si les paramètres sont inappropriés, une perte de signal se produira.

Le fait de ne pas suivre les instructions peut entraîner une défaillance de la protection fournie par l'équipement, ce qui peut entraîner des conséquences graves, comme des blessures ou des dommages à l'équipement.

A Dimension drawing

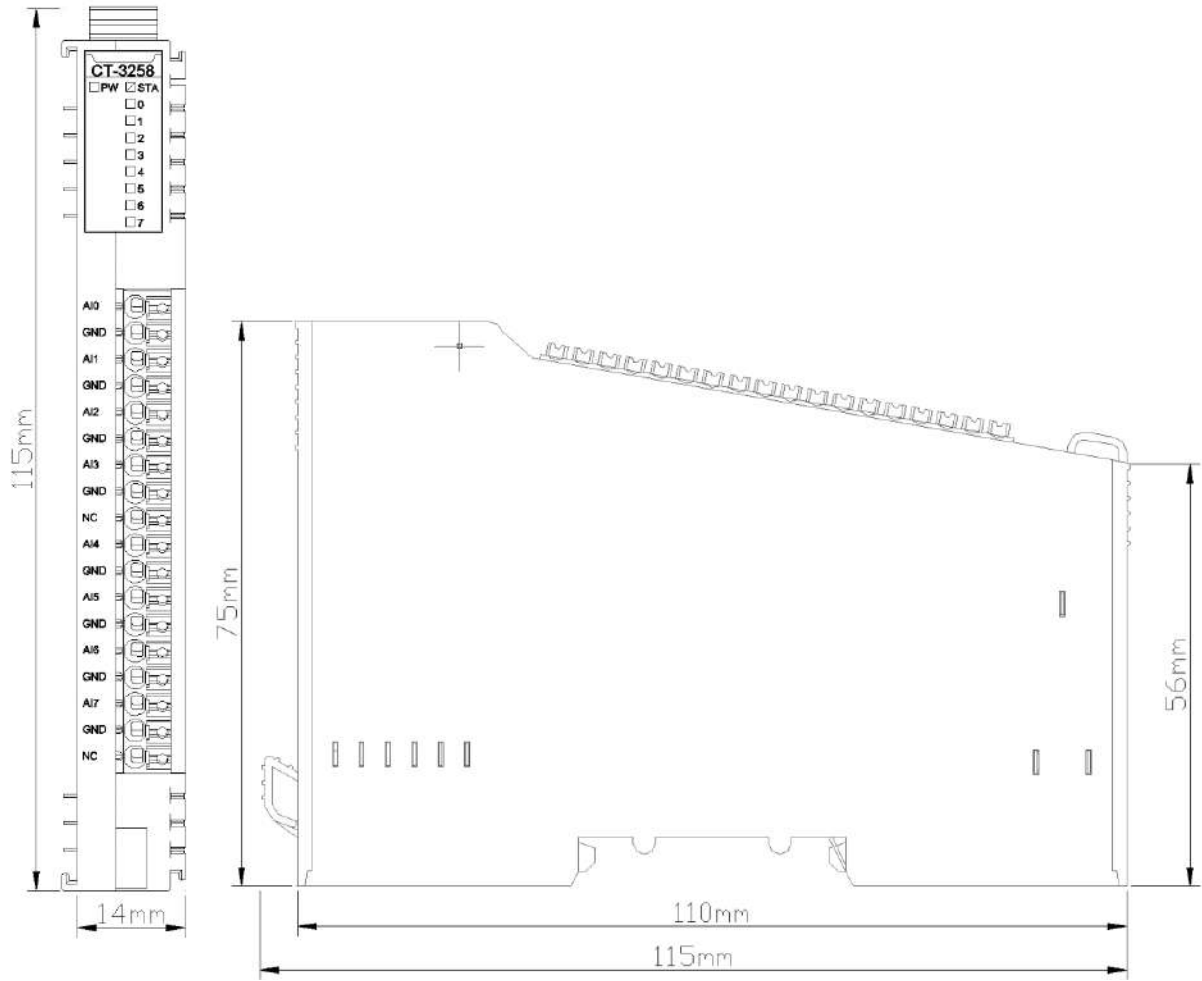

CT-3268 8 channels analog input /0 ~ 20mA OR -20~0mA OR ±20mA /15bit Single-ended bipolar

1 Module features

- ◆ The module supports 8-channel current signal acquisition.
- ◆ The module can be configured for 0~20mA or -20~0mA or ±20mA current signal acquisition.
- ◆ The module supports 2-wire (non-loop output, external power supply is required)
- ◆ The internal bus of the module and field input adopts magnetic insulation.
- ◆ The module input channel is to be connected to the field active analog signal current output sensor.
- ◆ The module channel equips with TVS overvoltage protection.

2 Technical parameters

General Parameters	
Power	Max.65mA@5.0VDC
Isolation	I/O to internal bus: magnetic isolation (2.5KVrms) Power isolation: DC-DC
Wiring	Max.: AWG 18 Min.: AWG 24
Installation	35mm DIN-Rail
Size	115*14*75mm
Weight	65g
Environmental parameters	
Operating Temperature of Horizontal Installation	-35°C~70°C
Operating Temperature of Vertical Installation	-35°C~60°C
Relative Humidity	< 95%RH (No Condensation)
Storage Temperature	-40°C~85°C
Storage Humidity	< 95%RH (No Condensation)
Manufacturing Test Temperature	-40°C~75°C
Ingress Protection Rating	IP20
Input Parameters	
Channel Number	8 channels
LED Indicator	8 LED channel state indicators
Input Range	Maximum: -23.5~23.5mA
Resolution Ratio	15 Bit
Acquisition Precision	±0.3% full range, @25°C
	±0.5% full range, @-20~70°C
Sampling Rrate	4ms/8 channels
Data Format	16-bit signed integer
Working Temperature	Standard mode: Overflow 32767 Standard mode: Underflow -32768 Channel disabled: -32767

WARNING

UNEXPECTED EQUIPMENT OPERATION

Do not exceed any of the ratings specified in the environmental and electrical characteristics table.

Failure to follow instructions specified by the manufacturer may result in serious consequences such as death, personal injury, or damage to equipment since the protection provided by the equipment may be impaired.

 **AVERTISSEMENT**

FONCTIONNEMENT INATTENDU DE L'EQUIPEMENT

Ne dépassez aucune évaluation spécifiée dans le tableau de caractéristiques environnementales et électriques.

Le fait de ne pas suivre les instructions peut entraîner une défaillance de la protection fournie par l'équipement, ce qui peut entraîner des conséquences graves, comme des blessures ou des dommages à l'équipement.

3 Hardware interfaces

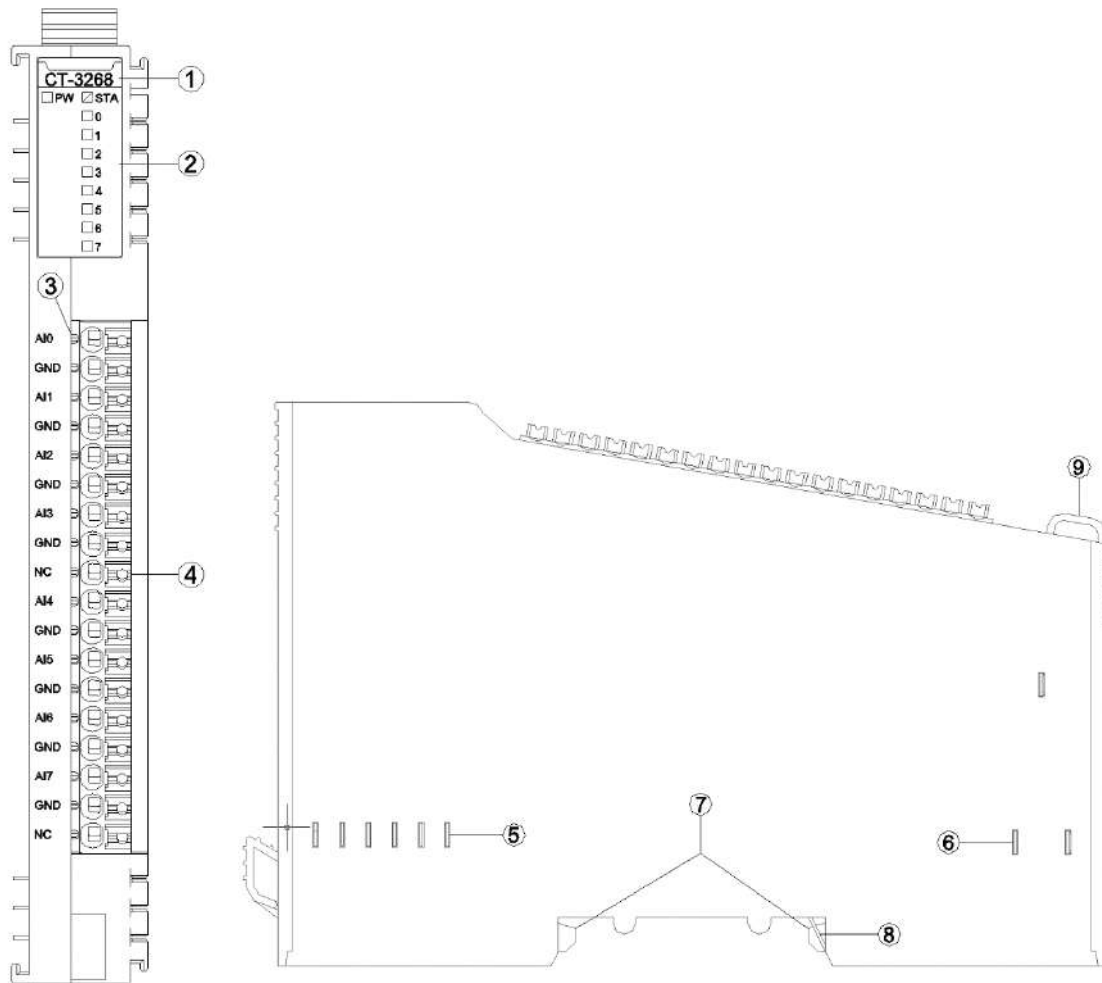

- ① Hardware interfaces
- ② State indicator
- ③ N/A
- ④ Wiring Terminal and marking
- ⑤ Internal Bus
- ⑥ Field Power
- ⑦ Buckle
- ⑧ Grounding Spring Sheet
- ⑨ Fixed Wiring Harness

3.1 LED indicator lights

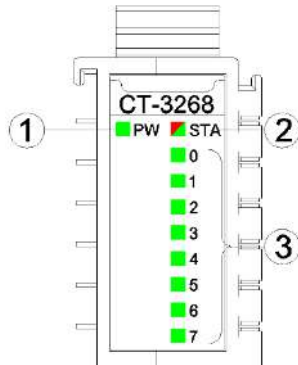

- ① Power indicator light (green)
- ② Module State indicator (red/green)
- ③ Input channel indicator light (green)

PW power indicator	Definition
ON	Internal bus power supply is normal
OFF	Internal bus power supply is failure
STA module State indicator	Definition
Green slow flash (2.5hz)	The internal bus of the module is not started
Red slow flash (2.5hz)	Module internal bus offline
Green on	Operation normal
Flash(2.5Hz) (RED/GREEN)	Upgrading mode
Flash(10Hz) (RED/GREEN)	Firmware upgrading
Red flashes twice	Module exception has been soft-restarted
0-7 channel indicator light	Definition
ON	Input signal $\geq 1\%$ range
OFF	Input signal $< 1\%$ range

⚠ WARNING

UNEXPECTED EQUIPMENT OPERATION

By viewing the PW indicator, could determine the power supply status of a module. If the PW is steady green, the power supply is normal. Otherwise, the module cannot work properly.

When the module is initially powered on, there will be 3S for the backplane bus connection. After the backplane bus is initialized, STA is in the green steady state. If STA is in the green blinking state, it indicates that the backplane bus has not been initialized, and it needs to be powered off and restarted for re-initialization.

STA abnormal working state occurs during the normal operation of the module, please check the firmware version information of all modules, and consult ODOT technical support for details.

If a module is upgraded, check that all modules are in the normal state after the upgrade. Otherwise, an exception may occur.

Failure to follow instructions specified by the manufacturer may result in serious consequences such as death, personal injury, or damage to equipment since the protection provided by the equipment may be impaired.

AVERTISSEMENT

FONCTIONNEMENT INATTENDU DE L'EQUIPEMENT

En regardant l'état de l'indicateur de PW, jugez l'état d'alimentation du module. Le feu vert PW reste allumé et l'alimentation est normale. Autrement, le module ne fonctionnera pas correctement.

Lorsque le module est alimenté initialement, il y aura 3S pour la connexion de bus de backboard. STA est un état vert permanent après l'initialisation du bus de backboard. Si STA est en état de clignotement vert, cela signifie que l'initialisation du bus de backboard n'est pas passée et doit être redémarrée hors tension et réinitialisée.

L'état de fonctionnement anormal de STA se produit pendant le fonctionnement normal du module, veuillez vérifier les informations de version du firmware de tous les modules, et consulter le support technique ODOT pour plus de détails.

Si le module a une opération de mise à niveau, après l'achèvement de la mise à niveau, le besoin de vérifier que tous les modules sont dans l'état normal avant de courir, sinon il conduira à une exception.

Le fait de ne pas suivre les instructions peut entraîner une défaillance de la protection fournie par l'équipement, ce qui peut entraîner des conséquences graves, comme des blessures ou des dommages à l'équipement.

3.2 Terminal definition

Terminal number	Definition	Description
1	AI0	Current input CH0
2	GND	
3	AI1	Current input CH1
4	GND	
5	AI2	Current input CH2
6	GND	
7	AI3	Current input CH3
8	GND	
9	NC	Not connected
10	AI4	Current input CH4
11	GND	
12	AI5	Current input CH5
13	GND	
14	AI6	Current input CH6
15	GND	
16	AI7	Current input CH7
17	GND	
18	NC	Not connected

WARNING

UNEXPECTED EQUIPMENT OPERATION

Calculate the maximum field power current consumption of a single module based on the actual field load. If the total field power current consumption of all I/O modules exceeds the power supply capacity of the field power supply, you must add an extra power expansion module. Otherwise, an output channel exception may occur.

Failure to follow instructions specified by the manufacturer may result in serious consequences such as death, personal injury, or damage to equipment since the protection provided by the equipment may be impaired.

AVERTISSEMENT

FONCTIONNEMENT INATTENDU DE L'EQUIPEMENT

Calculez la consommation maximale de courant de champ d'un seul module en fonction de la charge de champ réelle. Si la consommation totale de courant de champ de tous les modules d'E/S dépasse la capacité d'alimentation de l'alimentation de champ, vous devez ajouter un module d'extension de puissance supplémentaire. Dans le cas contraire, une exception de canal de sortie peut se produire.

Le fait de ne pas suivre les instructions peut entraîner une défaillance de la protection fournie

par l'équipement, ce qui peut entraîner des conséquences graves, comme des blessures ou des dommages à l'équipement.

When connecting a cold-pressed terminal, the terminal must be terminated and checked in strict accordance with the corresponding termination specifications or requirements, and connect the cold-pressed terminal according to the corresponding node serial number. The conductor should use copper conductor and the conductor core should be larger than 0.2mm² and smaller than 1mm² (AWG18~AWG24). Cold-pressed terminal parameters are as follows:

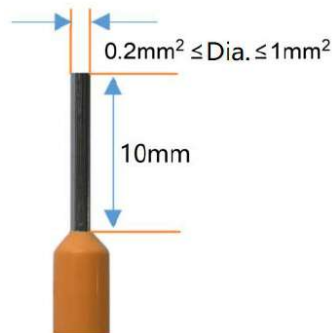

⚠️ WARNING

UNEXPECTED EQUIPMENT OPERATION

Strip the length of the conductor insulation layer is greater than 10mm to ensure reliable signal connection.

The wire needs to use copper wire and the wire core is greater than or equal to 0.2mm² and less than or equal to 1mm² to ensure reliable signal connection.

When connecting a cold-press terminal, connect the cold-press terminal strictly in accordance with the corresponding termination specifications or requirements, and connect the cold-press terminal according to the corresponding node serial number.

Do not power on cold-press terminals until they are properly connected or fully locked.

Failure to follow instructions specified by the manufacturer may result in serious consequences such as death, personal injury, or damage to equipment since the protection provided by the equipment may be impaired.

⚠️ AVERTISSEMENT

FONCTIONNEMENT INATTENDU DE L'EQUIPEMENT

Dépouillez la longueur de la couche isolante du fil plus de 10mm pour assurer la connexion fiable du signal.

Le conducteur doit utiliser le fil de cuivre et le noyau de fil est supérieur ou égal à 0,2 mm², inférieur ou égal à 1mm², afin d'assurer la connexion fiable du signal.

Lorsque les terminaux de presse à froid sont terminés, ils doivent être terminés et visualisés en stricte conformité avec les spécifications ou les exigences correspondantes et terminés selon le numéro de série de noeud correspondant.

Il est interdit d'activer les bornes à froid avant qu'elles ne soient correctement articulées ou complètement verrouillées.

Le fait de ne pas suivre les instructions peut entraîner une défaillance de la protection fournie par l'équipement, ce qui peut entraîner des conséquences graves, comme des blessures ou des dommages à l'équipement.

DANGER

FIRE DANGER

Use the correct wiring rules only for the maximum current capacity of the I/O channel and power supply.

Failure to follow instructions specified by the manufacturer may result in serious consequences such as death, personal injury, or damage to equipment since the protection provided by the equipment may be impaired.

WARNING

UNEXPECTED EQUIPMENT OPERATION

Do not exceed any of the ratings specified in the environmental and electrical characteristics table.

Failure to follow instructions specified by the manufacturer may result in serious consequences such as death, personal injury, or damage to equipment since the protection provided by the equipment may be impaired.

AVERTISSEMENT

FONCTIONNEMENT INATTENDU DE L'EQUIPEMENT

Ne dépassez aucune évaluation spécifiée dans le tableau de caractéristiques environnementales et électriques..

Le fait de ne pas suivre les instructions peut entraîner une défaillance de la protection fournie par l'équipement, ce qui peut entraîner des conséquences graves, comme des blessures ou des dommages à l'équipement.

4 Wiring

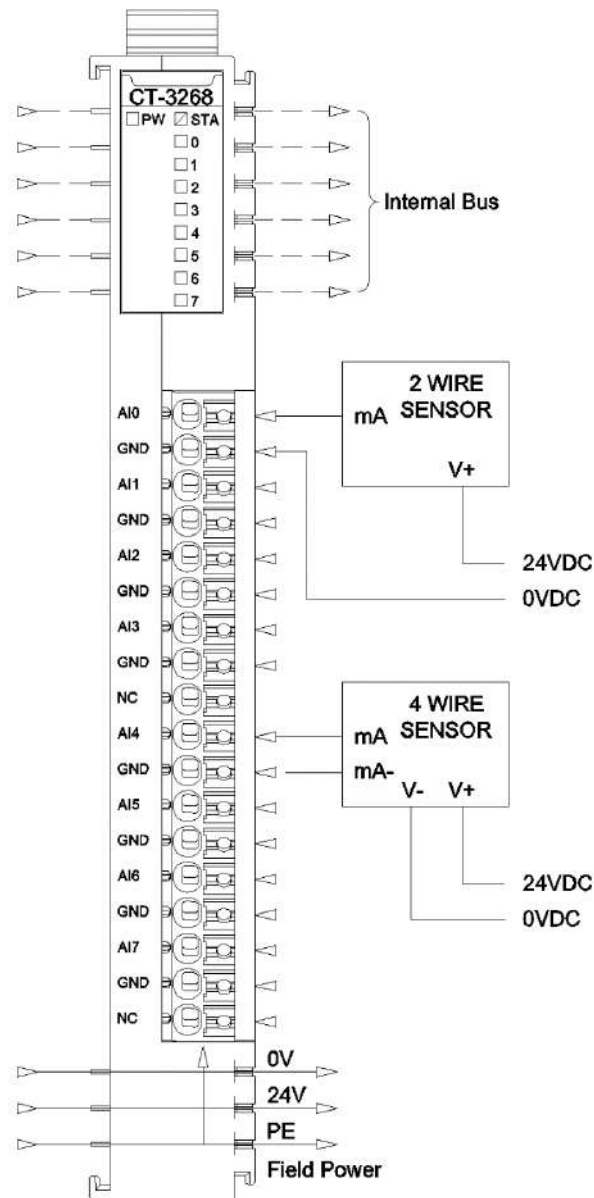

NOTICE

EQUIPMENT INOPERABLE

Do not crimp the spring terminal with more than the maximum pressure specified for the terminal. Otherwise, the resilience of the spring terminal may be damaged and the terminal rebound may be affected.

Do not press the spring terminal with a sharp tool when removing cable from the channel. Otherwise, the spring terminal will be damaged.

Failure to follow these instructions may result in equipment damage.

 **WARNING**

UNEXPECTED EQUIPMENT OPERATION

Do not link wires to unused terminals and/or terminals marked "NO CONNECTION (NC)"
Failure to follow instructions specified by the manufacturer may result in serious consequences such as death, personal injury, or damage to equipment since the protection provided by the equipment may be impaired.

 **AVERTISSEMENT**

FONCTIONNEMENT INATTENDU DE L'EQUIPEMENT

Ne reliez pas les fils aux terminaux inutilisés et/ou aux terminaux marqués «NO CONNECTION (NC)»

Le fait de ne pas suivre les instructions peut entraîner une défaillance de la protection fournie par l'équipement, ce qui peut entraîner des conséquences graves, comme des blessures ou des dommages à l'équipement.

5 Process data definition

Input data								
Bit No	Bit 7	Bit 6	Bit 5	Bit 4	Bit 3	Bit 2	Bit 1	Bit 0
Byte 0	Analog Input Data (CH 0)							
Byte 1								
Byte 2	Analog Input Data (CH 1)							
Byte 3								
Byte 4	Analog Input Data (CH 2)							
Byte 5								
Byte 6	Analog Input Data (CH 3)							
Byte 7								
Byte 8	Analog Input Data (CH 4)							
Byte 9								
Byte 10	Analog Input Data (CH 5)							
Byte 11								
Byte 12	Analog Input Data (CH 6)							
Byte 13								
Byte 14	Analog Input Data (CH 7)							
Byte 15								

5.1 Process data definition (standard mode)

Data description:

Analog Input Data (CH0-7): input value of the corresponding channel current signal.

Analog Input Data (CT-3268)			
Current (0-20mA)	Decimal	Hexadecimal	Remark
>23.52	32767	7FFF	Overflow
23.52	32511	7EFF	Exceed the upper limit
.	.	.	
>20	27649	6C01	
20	27648	6C00	Rated range
.	.	.	
10	13824	3600	
.	.	.	
0	0	0	
<0	0	0	Exceed the lower

	.	.	limit
-3.52	-4864	ED00	
<-23.52	-32767	7FFF	Channel disabled
<-3.52	-32768	8000	Underflow
Analog Input Data (CT-3268)			
Current (-20-0mA)	Decimal	Hexadecimal	Remark
>3.52	32767	7FFF	Overflow
3.52	4864	1300	Exceed the upper limit
.	.	.	
>0	0	0	
0	0	0	Rated range
.	.	.	
-10	-13824	CA00	
.	.	.	
-20	-27648	9400	
<-20	-27949	93FF	Exceed the lower limit
.	.	.	
-23.52	-32511	8101	
<-23.52	-32767	7FFF	Channel disabled
<-23.52	-32768	8000	Underflow

Analog Input Data (CT-3268)			
Current (-20-20mA)	Decimal	Hexadecimal	Remark
>23.52	32767	7FFF	Overflow
23.52	32511	7EFF	Exceed the upper limit
.	.	.	
>20	27649	6C01	
20	27648	6C00	Rated range
.	.	.	
10	13824	3600	
.	.	.	
0	0	0	
.	.	.	
-10	-13824	CA00	
.	.	.	
-20	-27648	9400	

<-20	-27949	93FF	Exceed the lower limit
.	.	.	
-23.52	-32511	8101	
<-23.52	-32767	7FFF	Channel disabled
<-23.52	-32768	8000	Underflow

5.2 Process data definition (special mode)

Data description:

Analog Input Data (CH0-7): input value of the corresponding channel current signal.

Analog Input Data (CT-3268)					
Current (0-20mA)	Current (-20-0mA)	Current (±20mA)	Decimal	Hexadecimal	Remarks
20	.	20	32767	7FFF	Normal range
.	
10	.	10	13824	3600	
.	
0	0	0	0	0	
<0	
.	-.10	-10	-13824	CA00	
.	
.	-.20	-20	-32768	8000	

6 Configuration parameter definition

Configuration parameter									
Bit No	Bit 7	Bit 6	Bit 5	Bit 4	Bit 3	Bit 2	Bit 1	Bit 0	
Byte 0	Reserved					Calculate Opposite Number	Data Range Mode	16Bit Data Format	
Byte 1	Current Type Ch#3		Current Type Ch#2		Current Type Ch#1		Current Type Ch#0		
Byte 2	Current Type Ch#7		Current Type Ch#6		Current Type Ch#5		Current Type Ch#4		
Byte 3	Filtering Time(CH0)								
Byte 4									
Byte 5	Filtering Time(CH1)								
Byte 6									
Byte 7	Filtering Time(CH2)								
Byte 8									
Byte 9	Filtering Time(CH3)								
Byte 10									
Byte 11	Filtering Time(CH4)								
Byte 12									
Byte 13	Filtering Time(CH5)								
Byte 14									
Byte 15	Filtering Time(CH6)								
Byte 16									
Byte 17	Filtering Time(CH7)								
Byte 18									
Byte 19	Reserved								

Data description:

16Bit Data Format: Analog data storage format. (default: 0)

0: A-B

1: B-A

Data Range Mode: Data mode (default: 0)

0: Standard mode

1: Special mode

Calculate Opposite Number: Calculate opposite number (default: 0)

0: Disable

1: Enable

Current Type Ch#(0-7): Type of input signal. (default: 0)

0: N/A

1: 0~20mA

2: -20~0mA

3: ±20mA

Filtering_Time Ch#(0-7): Filtering time。 (默认值:10)

Input range: 0~10000

Unit: ms

 **WARNING**

UNEXPECTED EQUIPMENT OPERATION

The filtering parameters could be adjusted according to the field conditions. If the parameter settings are inappropriate, the signal will be lost.

Input current type parameters can be adjusted according to the site conditions. If the parameter Settings are inappropriate, signal loss will occur.

Failure to follow instructions specified by the manufacturer may result in serious consequences such as death, personal injury, or damage to equipment since the protection provided by the equipment may be impaired.

 **AVERTISSEMENT**

FONCTIONNEMENT INATTENDU DE L'EQUIPEMENT

Les paramètres de filtrage peuvent être ajustés en fonction des conditions du site. Si les paramètres ne sont pas réglés correctement, la perte de signal se produira.

Les paramètres de type courant d'entrée peuvent être ajustés en fonction des conditions du site. Si les paramètres sont inappropriés, une perte de signal se produira.

Le fait de ne pas suivre les instructions peut entraîner une défaillance de la protection fournie par l'équipement, ce qui peut entraîner des conséquences graves, comme des blessures ou des dommages à l'équipement.

A Dimension drawing

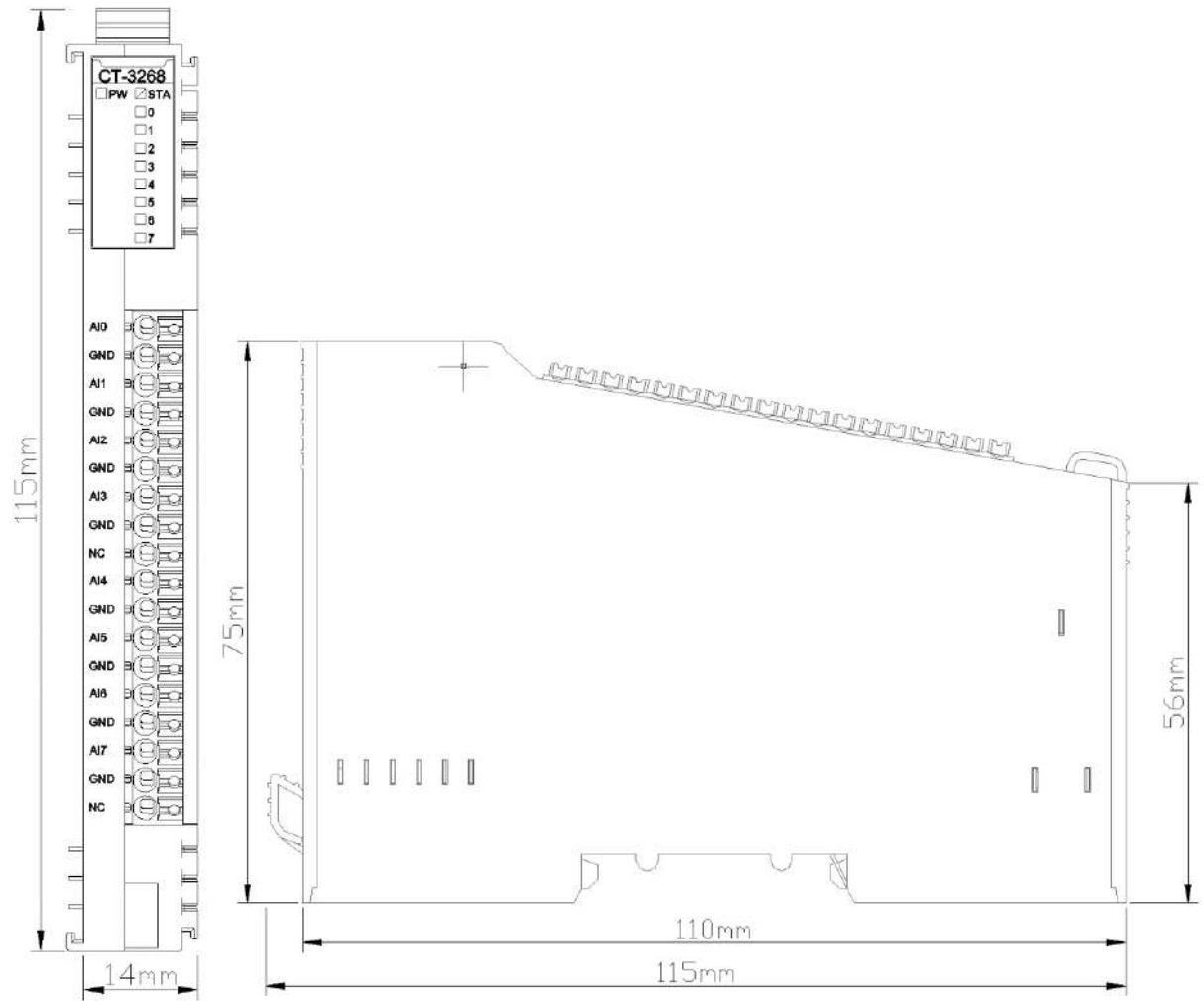

CT-3274 4 channels analog input /0&4-20mA/ ± 20 mA 16 bits differential input

1 Module features

- ◆ The module supports 4-channel current signal acquisition.
- ◆ The module can be configured for 0-20mA, 4-20mA or ± 20 mA current signal acquisition, 16 bits differential input.
- ◆ The module supports 2-wire (non-loop output, external power supply is required) or 4-wire current sensor input.
- ◆ Isolation between channels.
- ◆ Input acquisition precision is 0.1% (full range@25°C) or 0.3% (full range@-35~70°C).

2 Technical parameters

General Parameters	
Power	Max.175mA@5.0VDC
Isolation	The isolation voltage between the I/O channel and the system power supply: AC500V The isolation voltage between the I/O channel and the field power supply: AC500V Isolation voltage between the I/O channel and PE: AC 500V Isolation voltage between I/O channels: AC 500V
Field Power	NO
Wiring	Max.: AWG 18 Min.: AWG 24
Installation	35mm DIN-Rail
Size	115*14*75mm
Weight	65g
Environmental parameters	
Operating Temperature of Horizontal Installation	-35°C~70°C
Operating Temperature of Vertical Installation	-35°C~60°C
Relative Humidity	< 95%RH (No Condensation)
Storage Temperature	-40°C~85°C
Storage Humidity	< 95%RH (No Condensation)
Manufacturing Test Temperature	-40°C~75°C
Ingress Protection Rating	IP20
Input Parameters	
Channel Number	4 channels
LED Indicator	4 LED channel state indicators
Input Range	0~20mA, 4~20 mA, ± 20 mA, 16 bits differential input
Input Max. Voltage	DC 90V
Input Max. Current	25mA
Acquisition Precision	$\pm 0.1\%$ full range, @25°C
	$\pm 0.3\%$ full range, @-35~70°C
ADC Sampling Rate	1kHz
Input impedance	159 Ω
Sampling resistor	100 Ω
Input break detection	Support
EMC parameters	
Static Electricity	Air 8KV/ Contact 6KV

EFT	2KV
Surge	1KV

 WARNING

UNEXPECTED EQUIPMENT OPERATION

Do not exceed any of the ratings specified in the environmental and electrical characteristics table.

Failure to follow instructions specified by the manufacturer may result in serious consequences such as death, personal injury, or damage to equipment since the protection provided by the equipment may be impaired.

 AVERTISSEMENT

FONCTIONNEMENT INATTENDU DE L'EQUIPEMENT

Ne dépassez aucune évaluation spécifiée dans le tableau de caractéristiques environnementales et électriques.

Le fait de ne pas suivre les instructions peut entraîner une défaillance de la protection fournie par l'équipement, ce qui peut entraîner des conséquences graves, comme des blessures ou des dommages à l'équipement.

3 Hardware interface

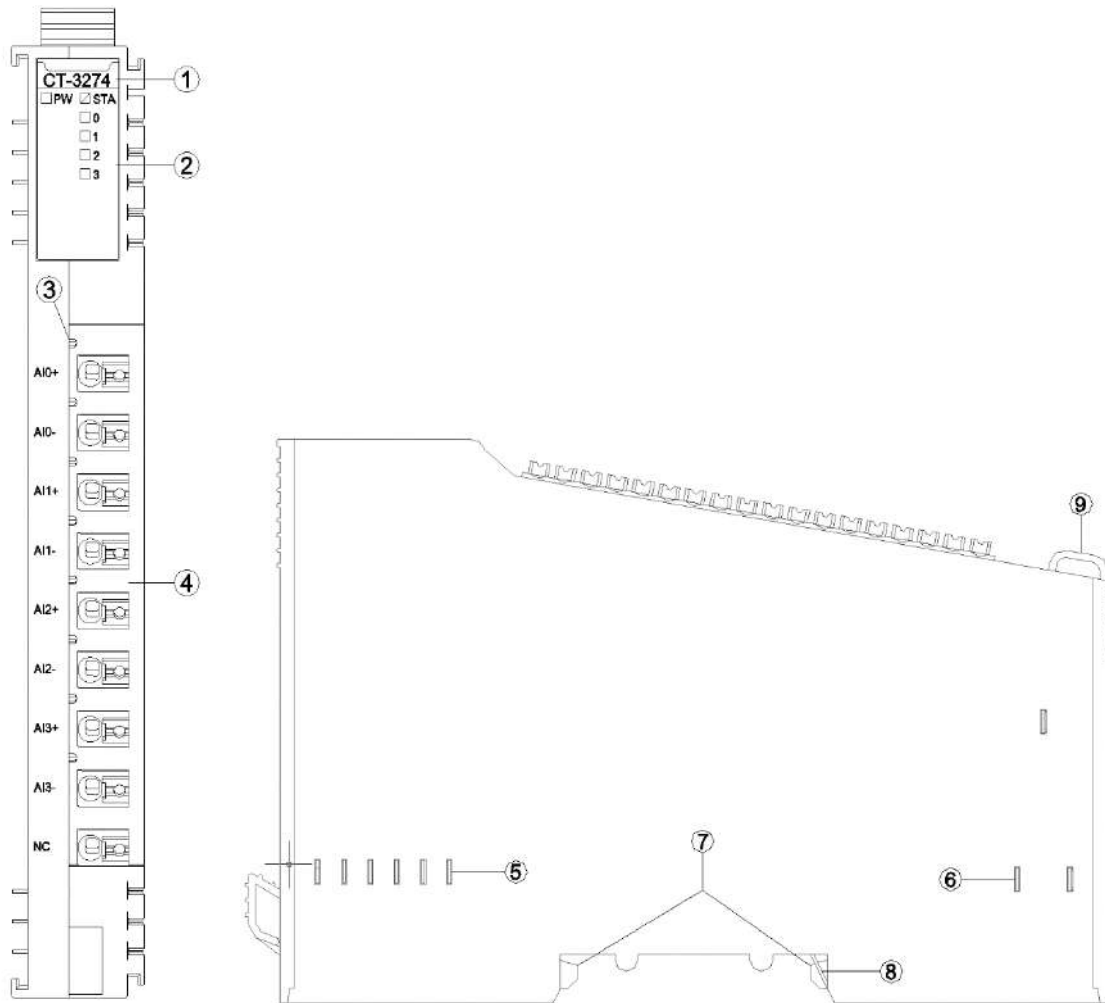

- ① Module Type
- ② State indicator
- ③ N/A
- ④ Wiring Terminal and identification
- ⑤ Internal Bus
- ⑥ Field Power
- ⑦ Buckle
- ⑧ Grounding Spring Sheet
- ⑨ Fixed Wiring Harness

3.1 LED indicator definition

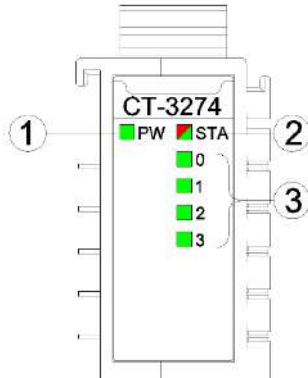

- ① Power indicator light (green)
- ② Module State indicator (red/green)
- ③ Input channel indicator light (green)

PW power indicator	Definition
ON	Internal bus power supply is normal
OFF	Internal bus power supply is failure
STA module State indicator	Definition
Green slow flash (2.5hz)	The internal bus of the module is not started
Red slow flash (2.5hz)	Module internal bus offline
Green on	Operation normal
Flash(2.5Hz) (RED/GREEN)	Upgrading mode
Flash(10Hz) (RED/GREEN)	Firmware upgrading
Red flashes twice	Module exception has been soft-restarted
0-3 channel indicator light	Definition
ON	Input signal $\geq 1\%$ range
OFF	Input signal $< 1\%$ range

⚠ WARNING

UNEXPECTED EQUIPMENT OPERATION

By viewing the PW indicator, could determine the power supply status of a module. If the PW is steady green, the power supply is normal. Otherwise, the module cannot work properly.

When the module is initially powered on, there will be 3S for the backplane bus connection. After the backplane bus is initialized, STA is in the green steady state. If STA is in the green blinking state, it indicates that the backplane bus has not been initialized, and it needs to be powered off and restarted for re-initialization.

STA abnormal working state occurs during the normal operation of the module, please check the firmware version information of all modules, and consult ODOT technical support for details.

If a module is upgraded, check that all modules are in the normal state after the upgrade. Otherwise, an exception may occur.

Failure to follow instructions specified by the manufacturer may result in serious consequences such as death, personal injury, or damage to equipment since the protection provided by the equipment may be impaired.

AVERTISSEMENT

FONCTIONNEMENT INATTENDU DE L'EQUIPEMENT

En regardant l'état de l'indicateur de PW, jugez l'état d'alimentation du module. Le feu vert PW reste allumé et l'alimentation est normale. Autrement, le module ne fonctionnera pas correctement.

Lorsque le module est alimenté initialement, il y aura 3S pour la connexion de bus de backboard. STA est un état vert permanent après l'initialisation du bus de backboard. Si STA est en état de clignotement vert, cela signifie que l'initialisation du bus de backboard n'est pas passée et doit être redémarrée hors tension et réinitialisée.

L'état de fonctionnement anormal de STA se produit pendant le fonctionnement normal du module, veuillez vérifier les informations de version du firmware de tous les modules, et consulter le support technique ODOT pour plus de détails.

Si le module a une opération de mise à niveau, après l'achèvement de la mise à niveau, le besoin de vérifier que tous les modules sont dans l'état normal avant de courir, sinon il conduira à une exception.

Le fait de ne pas suivre les instructions peut entraîner une défaillance de la protection fournie par l'équipement, ce qui peut entraîner des conséquences graves, comme des blessures ou des dommages à l'équipement.

3.2 Terminal definition

Terminal number	Definition	Description
1	AI0+	Current input CH0
2	AI0-	
3	AI1+	Current input CH1
4	AI1-	
5	AI2+	Current input CH2
6	AI2-	
7	AI3+	Current input CH3
8	AI3-	
9	NC	Not connected

WARNING

UNEXPECTED EQUIPMENT OPERATION

Calculate the maximum field power current consumption of a single module based on the actual field load. If the total field power current consumption of all I/O modules exceeds the power supply capacity of the field power supply, you must add an extra power expansion module. Otherwise, an output channel exception may occur.

Failure to follow instructions specified by the manufacturer may result in serious consequences such as death, personal injury, or damage to equipment since the protection provided by the equipment may be impaired.

AVERTISSEMENT

FONCTIONNEMENT INATTENDU DE L'EQUIPEMENT

Calculez la consommation maximale de courant de champ d'un seul module en fonction de la charge de champ réelle. Si la consommation totale de courant de champ de tous les modules d'E/S dépasse la capacité d'alimentation de l'alimentation de champ, vous devez ajouter un module d'extension de puissance supplémentaire. Dans le cas contraire, une exception de canal de sortie peut se produire.

Le fait de ne pas suivre les instructions peut entraîner une défaillance de la protection fournie par l'équipement, ce qui peut entraîner des conséquences graves, comme des blessures ou des dommages à l'équipement.

When connecting a cold-pressed terminal, the terminal must be terminated and checked in strict accordance with the corresponding termination specifications or requirements, and connect the cold-pressed terminal according to the corresponding

node serial number. The conductor should use copper conductor and the conductor core should be larger than 0.2mm^2 and smaller than 1mm^2 (AWG18~AWG24). Cold-pressed terminal parameters are as follows:

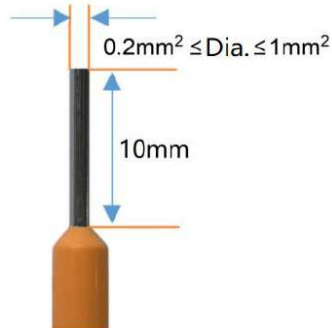

! WARNING

UNEXPECTED EQUIPMENT OPERATION

Strip the length of the conductor insulation layer is greater than 10mm to ensure reliable signal connection.

The wire needs to use copper wire and the wire core is greater than or equal to 0.2mm^2 and less than or equal to 1mm^2 to ensure reliable signal connection.

When connecting a cold-press terminal, connect the cold-press terminal strictly in accordance with the corresponding termination specifications or requirements, and connect the cold-press terminal according to the corresponding node serial number.

Do not power on cold-press terminals until they are properly connected or fully locked.

Failure to follow instructions specified by the manufacturer may result in serious consequences such as death, personal injury, or damage to equipment since the protection provided by the equipment may be impaired.

! AVERTISSEMENT

FONCTIONNEMENT INATTENDU DE L'EQUIPEMENT

Dépouillez la longueur de la couche isolante du fil plus de 10mm pour assurer la connexion fiable du signal.

Le conducteur doit utiliser le fil de cuivre et le noyau de fil est supérieur ou égal à $0,2\text{ mm}^2$, inférieur ou égal à 1mm^2 , afin d'assurer la connexion fiable du signal.

Lorsque les terminaux de presse à froid sont terminés, ils doivent être terminés et visualisés en stricte conformité avec les spécifications ou les exigences correspondantes et terminés selon le numéro de série de noeud correspondant.

Il est interdit d'activer les bornes à froid avant qu'elles ne soient correctement articulées ou complètement verrouillées.

Le fait de ne pas suivre les instructions peut entraîner une défaillance de la protection

fournie par l'équipement, ce qui peut entraîner des conséquences graves, comme des blessures ou des dommages à l'équipement.

DANGER

FIRE DANGER

Use the correct wiring rules only for the maximum current capacity of the I/O channel and power supply.

Failure to follow instructions specified by the manufacturer may result in serious consequences such as death, personal injury, or damage to equipment since the protection provided by the equipment may be impaired.

WARNING

UNEXPECTED EQUIPMENT OPERATION

Do not exceed any of the ratings specified in the environmental and electrical characteristics table.

Failure to follow instructions specified by the manufacturer may result in serious consequences such as death, personal injury, or damage to equipment since the protection provided by the equipment may be impaired.

AVERTISSEMENT

FONCTIONNEMENT INATTENDU DE L'EQUIPEMENT

Ne dépassez aucune évaluation spécifiée dans le tableau de caractéristiques environnementales et électriques..

Le fait de ne pas suivre les instructions peut entraîner une défaillance de la protection fournie par l'équipement, ce qui peut entraîner des conséquences graves, comme des blessures ou des dommages à l'équipement.

4 Wiring

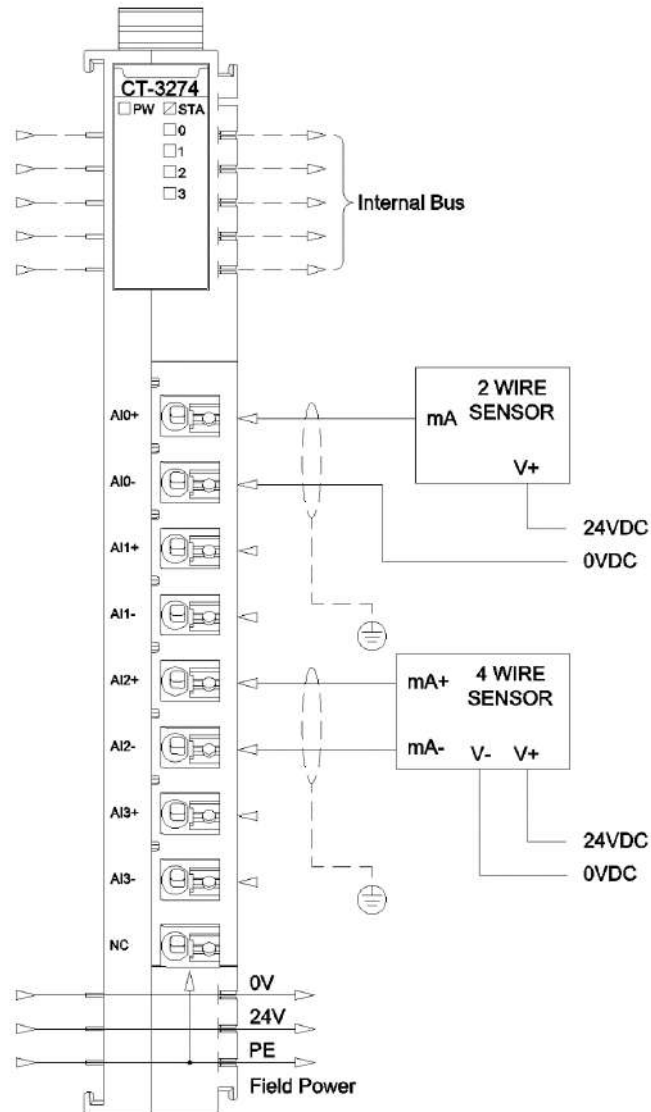

NOTICE

EQUIPMENT INOPERABLE

Do not crimp the spring terminal with more than the maximum pressure specified for the terminal. Otherwise, the resilience of the spring terminal may be damaged and the terminal rebound may be affected.

Do not press the spring terminal with a sharp tool when removing cable from the channel. Otherwise, the spring terminal will be damaged.

Failure to follow these instructions may result in equipment damage.

 **WARNING**

UNEXPECTED EQUIPMENT OPERATION

Do not link wires to unused terminals and/or terminals marked "NO CONNECTION (NC)"
Failure to follow instructions specified by the manufacturer may result in serious consequences such as death, personal injury, or damage to equipment since the protection provided by the equipment may be impaired.

 **AVERTISSEMENT**

FONCTIONNEMENT INATTENDU DE L'EQUIPEMENT

Ne reliez pas les fils aux terminaux inutilisés et/ou aux terminaux marqués «NO CONNECTION (NC)»

Le fait de ne pas suivre les instructions peut entraîner une défaillance de la protection fournie par l'équipement, ce qui peut entraîner des conséquences graves, comme des blessures ou des dommages à l'équipement.

5 Process data definition

Input data								
Bit No	Bit 7	Bit 6	Bit 5	Bit 4	Bit 3	Bit 2	Bit 1	Bit 0
Byte 0	Analog Input Data (CH 0)							
Byte 1								
Byte 2	Analog Input Data (CH 1)							
Byte 3								
Byte 4	Analog Input Data (CH 2)							
Byte 5								
Byte 6	Analog Input Data (CH 3)							
Byte 7								

Data description :

Analog Input Data (CH0-3): Analog signal Input value of corresponding channel.

Analog Input Data (CT-3274)			
Current (0-20mA)	Decimal	Hexadecimal	Description
>23.515	32767	7FFF	Overflow
>23.515	32765	7FFD	ADC fault
23.515	32511	7EFF	Exceed the upper limit
.	.	.	
20.0007	27649	6C01	
20	27648	6C00	Rated range
.	.	.	
0	0	0	
-0.0007	-1	FFFF	Exceed the lower limit
.	.	.	
-3.52	-4864	ED00	
<3.52	-32767	7FFF	Channel disabled
<3.52	-32768	8000	Underflow

Analog Input Data (CT-3274)			
Current (4-20mA)	Decimal	Hexadecimal	Description
>22.81	32767	7FFF	Overflow
>22.81	32765	7FFD	ADC fault
22.81	32511	7EFF	Exceed the upper limit
.	.	.	
20.0005	27649	6C01	

20	27648	6C00	Rated range
.	.	.	
4	0	0	
3.9995	-1	FFFF	Exceed the lower limit
.	.	.	
1.1852	-4864	ED00	
<1.1852	-32767	7FFF	Channel disabled
<1.1852	-32768	8000	Underflow

Analog Input Data (CT-3274)			
Current (-20-20mA)	Decimal	Hexadecimal	Description
>23.515	32767	7FFF	Overflow
>23.515	32765	7FFD	ADC fault
23.515	32511	7EFF	Exceed the upper limit
.	.	.	
20.0007	27649	6C01	
20	27648	6C00	Rated range Exceed the lower limit
.	.	.	
0	0	0	
.	.	.	
-20	-27648	9400	超出下限 Channel disabled
-0.0007	-1	FFFF	
.	.	.	
-23.52	-32511	7EFF	Overflow
<-23.52	-32767	7FFF	
<-23.52	-32768	8000	

6 Configuration parameter definition

Configuration parameters								
Bit No	Bit 7	Bit 6	Bit 5	Bit 4	Bit 3	Bit 2	Bit 1	Bit 0
Byte 0	Reserved							16Bit Data Format
Byte 1	Reserved				Channel Enable Ch#3	Channel Enable Ch#2	Channel Enable Ch#1	Channel Enable Ch#0
Byte 2	Reserved				Current Type Ch#3	Current Type Ch#2	Current Type Ch#1	Current Type Ch#0
Byte 3	Ch#0 Filter Level							
Byte 4	Ch#1 Filter Level							
Byte 5	Ch#2 Filter Level							
Byte 6	Ch#3 Filter Level							
Byte 7 ... Byte 10	Reserved							

Data description:

16Bit Data Format: Analog data storage format (default: 0).

0: A-B

1: B-A

Channel Enable Ch#(0-3): Type of channel enable (default: 1).

0: Disable

1: Enable

Current Type Ch#(0-3): Type of input signal (default: 1).

0: 0-20mA

1: 4-20mA

2: ± 20 mA

Filter Level Ch#(0-3): Filter level (default: 0).

0: level 0

1: level 1

- 2: level 2
- 3: level 3
- 4: level 4
- 5: level 5
- 6: level 6
- 7: level 7
- 8: level 8
- 9: level 9
- 10: level 10

 **WARNING**

UNEXPECTED EQUIPMENT OPERATION

The filtering parameters could be adjusted according to the field conditions. If the parameter settings are inappropriate, the signal will be lost.

Input current type parameters can be adjusted according to the site conditions. If the parameter Settings are inappropriate, signal loss will occur.

Failure to follow instructions specified by the manufacturer may result in serious consequences such as death, personal injury, or damage to equipment since the protection provided by the equipment may be impaired.

 **AVERTISSEMENT**

FONCTIONNEMENT INATTENDU DE L'EQUIPEMENT

Les paramètres de filtrage peuvent être ajustés en fonction des conditions du site. Si les paramètres ne sont pas réglés correctement, la perte de signal se produira.

Les paramètres de type courant d'entrée peuvent être ajustés en fonction des conditions du site. Si les paramètres sont inappropriés, une perte de signal se produira.

Le fait de ne pas suivre les instructions peut entraîner une défaillance de la protection fournie par l'équipement, ce qui peut entraîner des conséquences graves, comme des blessures ou des dommages à l'équipement.

A Dimension drawing

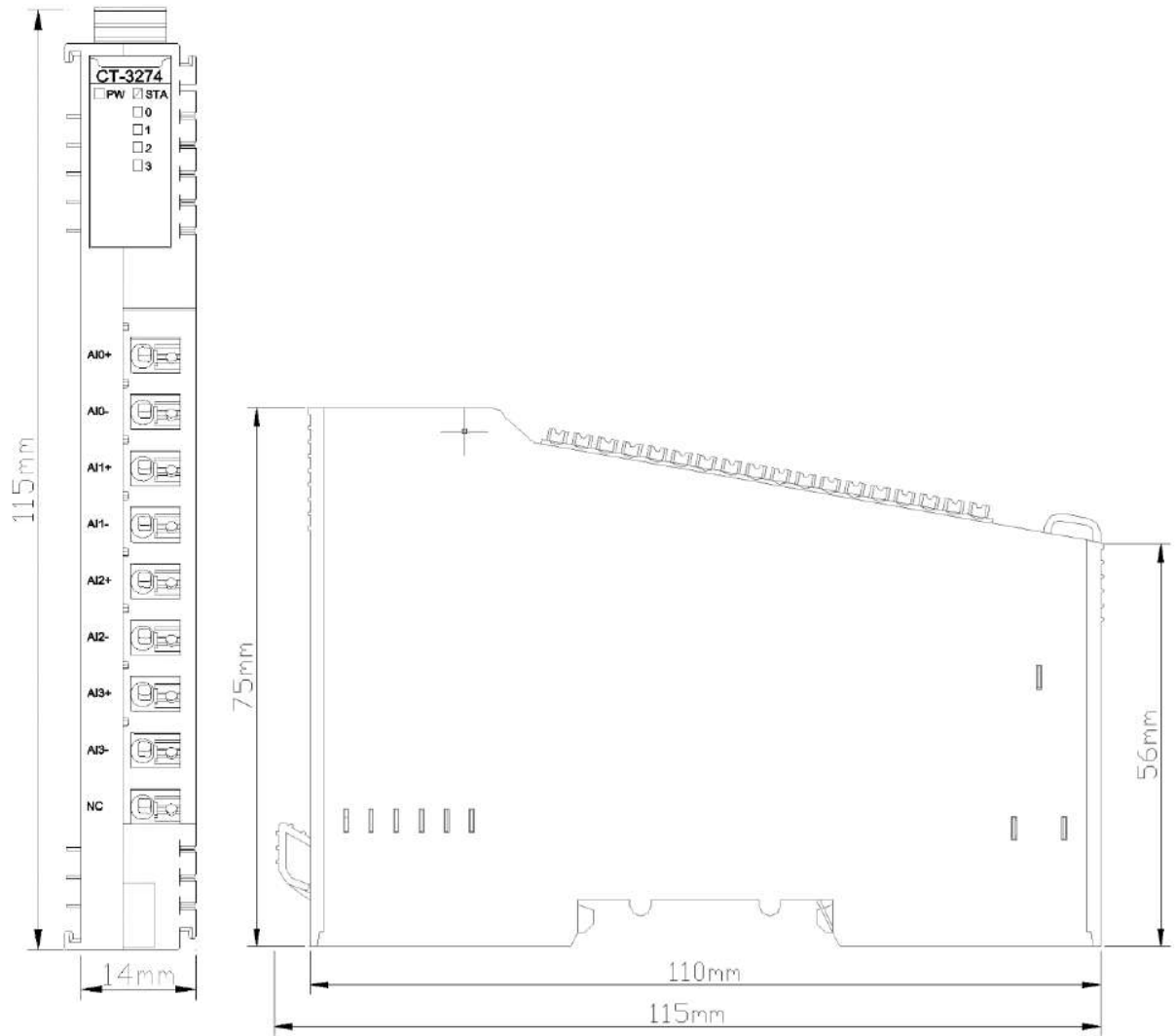

CT-3713 3 channels RTD-PT100 temperature acquisition module

1 Module features

- ◆ The module supports 3-channel RTD thermal resistance (PT100) temperature acquisition
- ◆ The module could be connected to a 2-wire or 3-wire PT100 temperature sensor
- ◆ The internal bus of the module and field input adopts magnetic isolation
- ◆ The module carries with 3 analog input channel LED indicator
- ◆ 15-bit ADC resolution

2 Technical Parameters

General Parameters	
Power	Max.35mA@5.0Vdc
Isolation	I/O to internal bus: magnetic isolation (2.5KVrms)
Field Power	Not used
Wiring	Max: AWG 18
Mounting Type	35mmDIN-Rail
Size	115*14*75mm
Weight	65g
Environment Specification	
Operating Temperature of Horizontal Installation	-35°C~70°C
Operating Temperature of Vertical Installation	-35°C~60°C
Relative Humidity	< 95%RH (No Condensation)
Storage Temperature	-40°C~85°C
Storage Humidity	< 95%RH (No Condensation)
Manufacturing Test Temperature	-40°C~75°C
Ingress Protection Rating	IP20
Input Parameter	
Channel Number	3 Channels
LED Indicator	3 Green LED
Resolution	15 bits
Sensor Type	PT100
Measurement Range	-240~870°C
Measurement Accuracy	0.5°C
Conversion Rate	400ms/3 channels
Diagnostic Function	32766: The sensor is not connected or the cable is disconnected -32766: short-circuit condition 32765: Chip failure 32767: Temperature overflow -32768: Temperature underflow

WARNING

UNEXPECTED EQUIPMENT OPERATION

Do not exceed any of the ratings specified in the environmental and electrical characteristics table.

Failure to follow instructions specified by the manufacturer may result in serious consequences such as death, personal injury, or damage to equipment since the protection provided by the equipment may be impaired.

 **AVERTISSEMENT**

FONCTIONNEMENT INATTENDU DE L'EQUIPEMENT

Ne dépassez aucune évaluation spécifiée dans le tableau de caractéristiques environnementales et électriques..

Le fait de ne pas suivre les instructions peut entraîner une défaillance de la protection fournie par l'équipement, ce qui peut entraîner des conséquences graves, comme des blessures ou des dommages à l'équipement.

3 Hardware Interface

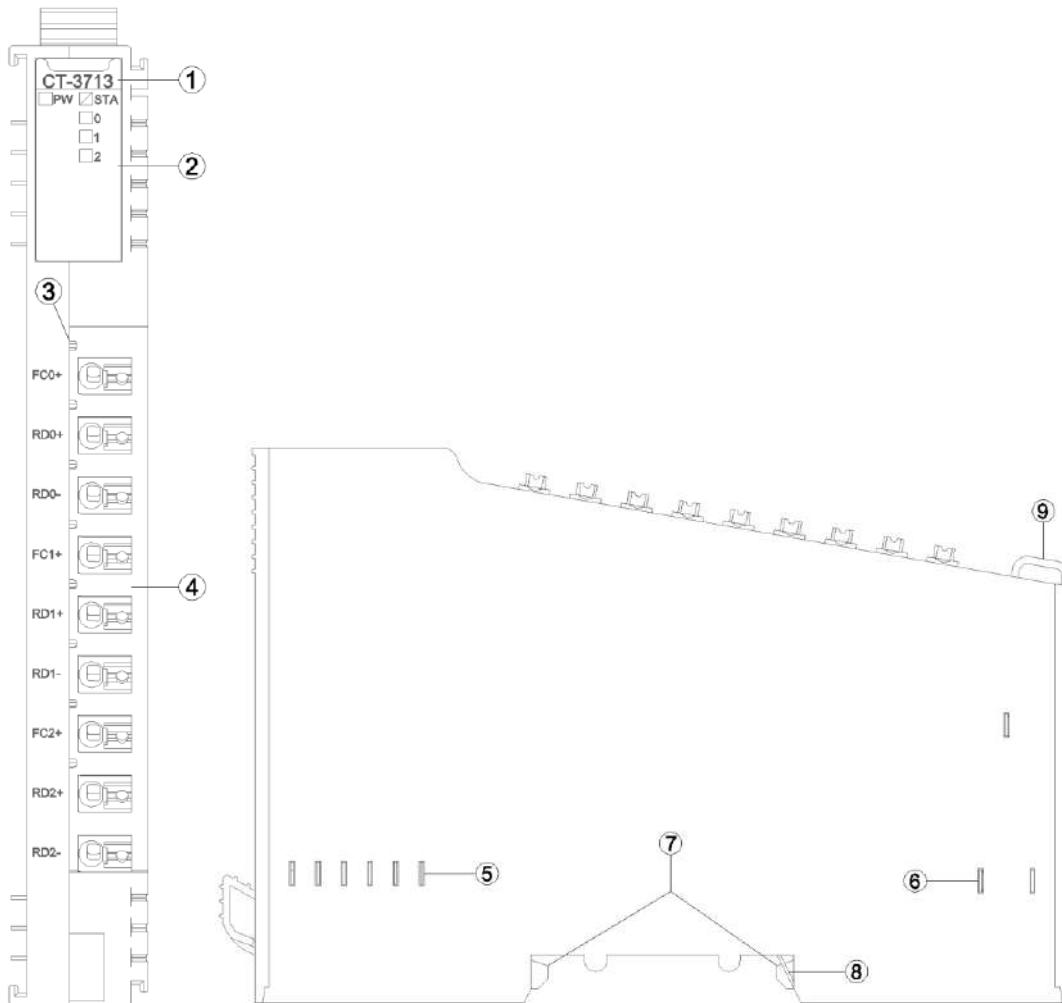

- ① Module Type
- ② State indicator
- ③ N/A
- ④ Wiring Terminal and identification
- ⑤ Internal Bus
- ⑥ Field Power
- ⑦ Buckle
- ⑧ Grounding Spring Sheet
- ⑨ Fixed Wiring Harness

3.1 LED indicator definition

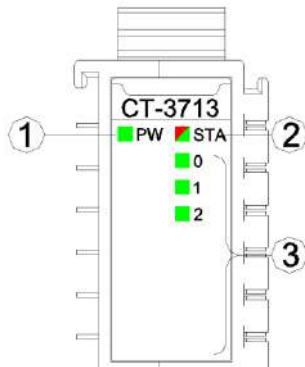

- ① Power LED indicator (green)
- ② Module State LED indicator (red/green)
- ③ Input channel LED indicator (green)

PW POWER STATE (GREEN)	Definition
ON	Internal bus Power Normal
OFF	Internal bus Power Failure
STA MODULE STATE (RED/GREEN)	Definition
Green slow flash (2.5Hz)	Module internal bus is not started
Red slow flash (2.5Hz)	Module internal bus offline
ON (GREEN)	Operation normal
Flash(2.5Hz) (RED/GREEN)	Upgrading mode
Flash(10Hz) (RED/GREEN)	Firmware Update
Double Flash (RED)	Module Exception has been soft-restarted
0-2 Channel Indicator	Definition
ON	The input signal exceeds 1% of the range
OFF	Invalid input signal

⚠️ WARNING

UNEXPECTED EQUIPMENT OPERATION

By viewing the PW indicator, could determine the power supply status of a module. If the PW is steady green, the power supply is normal. Otherwise, the module cannot work properly.

When the module is initially powered on, there will be 3S for the backplane bus connection. After the backplane bus is initialized, STA is in the green steady state. If STA is in the green blinking state, it indicates that the backplane bus has not been initialized, and it needs to be powered off and restarted for re-initialization.

STA abnormal working state occurs during the normal operation of the module, please check the firmware version information of all modules, and consult ODOT technical support for details.

If a module is upgraded, check that all modules are in the normal state after the upgrade. Otherwise, an exception may occur.

Failure to follow instructions specified by the manufacturer may result in serious consequences such as death, personal injury, or damage to equipment since the protection provided by the equipment may be impaired.

AVERTISSEMENT

FONCTIONNEMENT INATTENDU DE L'EQUIPEMENT

En regardant l'état de l'indicateur de PW, jugez l'état d'alimentation du module. Le feu vert PW reste allumé et l'alimentation est normale. Autrement, le module ne fonctionnera pas correctement.

Lorsque le module est alimenté initialement, il y aura 3S pour la connexion de bus de backboard. STA est un état vert permanent après l'initialisation du bus de backboard. Si STA est en état de clignotement vert, cela signifie que l'initialisation du bus de backboard n'est pas passée et doit être redémarrée hors tension et réinitialisée.

L'état de fonctionnement anormal de STA se produit pendant le fonctionnement normal du module, veuillez vérifier les informations de version du firmware de tous les modules, et consulter le support technique ODOT pour plus de détails.

Si le module a une opération de mise à niveau, après l'achèvement de la mise à niveau, le besoin de vérifier que tous les modules sont dans l'état normal avant de courir, sinon il conduira à une exception.

Le fait de ne pas suivre les instructions peut entraîner une défaillance de la protection fournie par l'équipement, ce qui peut entraîner des conséquences graves, comme des blessures ou des dommages à l'équipement.

3.2 Terminal definition

Terminal Number	Definition	Description
1	FC0+	Signal Input CH0
2	RD0+	
3	RD0-	
4	FC1+	Signal Input CH1
5	RD1+	
6	RD1-	
7	FC2+	Signal Input CH2
8	RD2+	
9	RD2-	

⚠ WARNING

UNEXPECTED EQUIPMENT OPERATION

Calculate the maximum field power current consumption of a single module based on the actual field load. If the total field power current consumption of all I/O modules exceeds the power supply capacity of the field power supply, you must add an extra power expansion module. Otherwise, an output channel exception may occur.

Failure to follow instructions specified by the manufacturer may result in serious consequences such as death, personal injury, or damage to equipment since the protection provided by the equipment may be impaired.

⚠ AVERTISSEMENT

FONCTIONNEMENT INATTENDU DE L'EQUIPEMENT

Calculez la consommation maximale de courant de champ d'un seul module en fonction de la charge de champ réelle. Si la consommation totale de courant de champ de tous les modules d'E/S dépasse la capacité d'alimentation de l'alimentation de champ, vous devez ajouter un module d'extension de puissance supplémentaire. Dans le cas contraire, une exception de canal de sortie peut se produire.

Le fait de ne pas suivre les instructions peut entraîner une défaillance de la protection fournie par l'équipement, ce qui peut entraîner des conséquences graves, comme des blessures ou des dommages à l'équipement.

When connecting a cold-pressed terminal, the terminal must be terminated and checked in strict accordance with the corresponding termination specifications or requirements, and connect the cold-pressed terminal according to the corresponding node serial number. The conductor should use copper conductor and the conductor core should be larger than 0.2mm^2 and smaller than 1mm^2 (AWG18~AWG24). Cold-pressed terminal parameters are as follows:



WARNING

UNEXPECTED EQUIPMENT OPERATION

Strip the length of the conductor insulation layer is greater than 10mm to ensure reliable signal connection.

The wire needs to use copper wire and the wire core is greater than or equal to 0.2mm² and less than or equal to 1mm² to ensure reliable signal connection.

When connecting a cold-press terminal, connect the cold-press terminal strictly in accordance with the corresponding termination specifications or requirements, and connect the cold-press terminal according to the corresponding node serial number.

Do not power on cold-press terminals until they are properly connected or fully locked.

Failure to follow instructions specified by the manufacturer may result in serious consequences such as death, personal injury, or damage to equipment since the protection provided by the equipment may be impaired.

AVERTISSEMENT

FONCTIONNEMENT INATTENDU DE L'ÉQUIPEMENT

Dépouillez la longueur de la couche isolante du fil plus de 10mm pour assurer la connexion fiable du signal.

Le conducteur doit utiliser le fil de cuivre et le noyau de fil est supérieur ou égal à 0,2 mm², inférieur ou égal à 1mm², afin d'assurer la connexion fiable du signal.

Lorsque les terminaux de presse à froid sont terminés, ils doivent être terminés et visualisés en stricte conformité avec les spécifications ou les exigences correspondantes et terminés selon le numéro de série de noeud correspondant.

Il est interdit d'activer les bornes à froid avant qu'elles ne soient correctement articulées ou complètement verrouillées.

Le fait de ne pas suivre les instructions peut entraîner une défaillance de la protection fournie par l'équipement, ce qui peut entraîner des conséquences graves, comme des blessures ou des dommages à l'équipement.

DANGER

FIRE DANGER

Use the correct wiring rules only for the maximum current capacity of the I/O channel and power supply.

Failure to follow instructions specified by the manufacturer may result in serious consequences such as death, personal injury, or damage to equipment since the protection provided by the equipment may be impaired.

 **WARNING**

UNEXPECTED EQUIPMENT OPERATION

Do not exceed any of the ratings specified in the environmental and electrical characteristics table.

Failure to follow instructions specified by the manufacturer may result in serious consequences such as death, personal injury, or damage to equipment since the protection provided by the equipment may be impaired.

 **AVERTISSEMENT**

FONCTIONNEMENT INATTENDU DE L'EQUIPEMENT

Ne dépassez aucune évaluation spécifiée dans le tableau de caractéristiques environnementales et électriques..

Le fait de ne pas suivre les instructions peut entraîner une défaillance de la protection fournie par l'équipement, ce qui peut entraîner des conséquences graves, comme des blessures ou des dommages à l'équipement.

4 Wiring

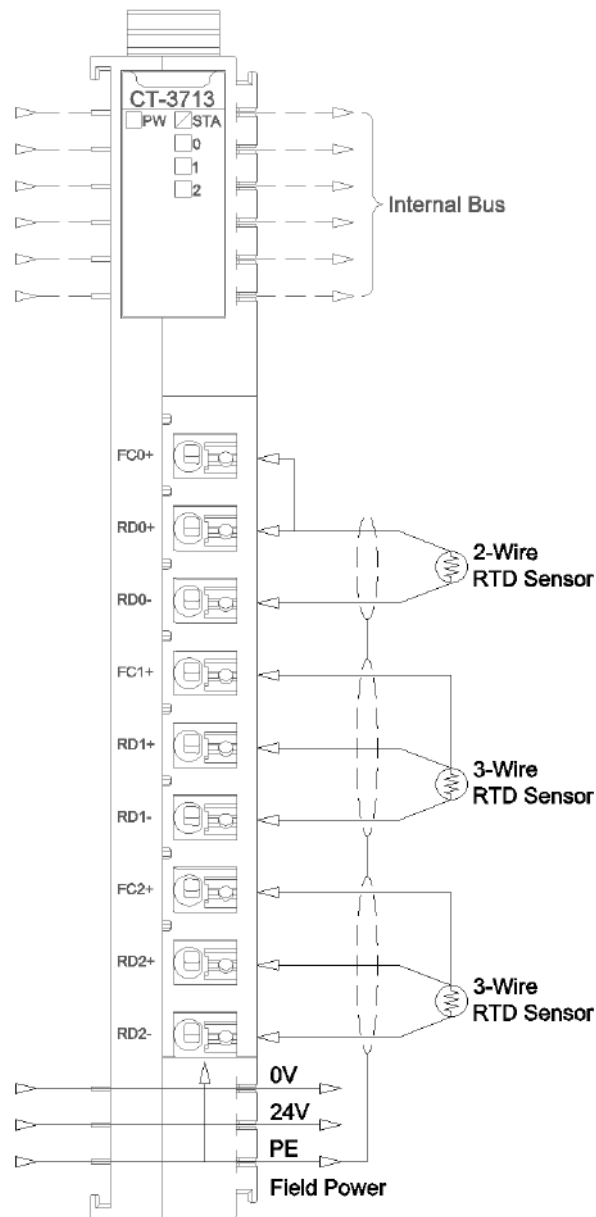

NOTICE

EQUIPMENT INOPERABLE

Do not crimp the spring terminal with more than the maximum pressure specified for the terminal. Otherwise, the resilience of the spring terminal may be damaged and the terminal rebound may be affected.

Do not press the spring terminal with a sharp tool when removing cable from the channel. Otherwise, the spring terminal will be damaged.

Failure to follow these instructions may result in equipment damage.

5 Process data definition

Input Data								
Bit No	Bit 7	Bit 6	Bit 5	Bit 4	Bit 3	Bit 2	Bit 1	Bit 0
Byte 0	Analog Input Data(CH 0)							
Byte 1								
Byte 2	Analog Input Data(CH 1)							
Byte 3								
Byte 4	Analog Input Data(CH 2)							
Byte 5								

Data description:

Analog Input Data (CH0-2): Analog channel input data values

Process Data Definition			
Temperature	Decimal	Hex	Location
>870.0	32767	7FFF	Overflow
>870.0	32766	7FFE	Channel break
>870.0	32765	7FFD	ADC Chip fault
>870.0	32764	7FFC	Overvoltage and undervoltage fault
>870.0	32763	7FFB	ADC Conversion fault
870.0	8800	2260	Exceeds the upper limit
.	.	.	
.	.	.	
850.1	8501	2135	Rated range
850.0	8500	2134	
.	.	.	
.	.	.	
-200.0	-2000	F830	Exceeds the lower limit
-200.1	-2001	F82F	
.	.	.	
.	.	.	
-240.0	-2400	F6A0	Channel disable
<-240.0	-32767	7FFF	
<-240.0	-32768	8000	Underflow

6 Configuration parameters definition

Configuration parameter								
Bit No	Bit 7	Bit 6	Bit 5	Bit 4	Bit 3	Bit 2	Bit 1	Bit 0
Byte 0	Number_of_filter_samples					Temperature Unit		16Bit Data Format

Data description:

16Bit Data Format: Sequence of 16-bit data byte transmission (Default: 0)

0: A_B

1: B_A

Temperature Unit: Temperature Unit. °C, °F or K are optional. (Default: 0)

0: °C

1: °F

2: K

Filter frequency(CH 0~CH5): Number of filtering, 1-31 could be set. (Default: 10)

WARNING

UNEXPECTED EQUIPMENT OPERATION

The filtering parameters could be adjusted according to the field conditions. If the parameter settings are inappropriate, the signal will be lost.

Failure to follow instructions specified by the manufacturer may result in serious consequences such as death, personal injury, or damage to equipment since the protection provided by the equipment may be impaired.

AVERTISSEMENT

FONCTIONNEMENT INATTENDU DE L'EQUIPEMENT

Les paramètres de filtrage peuvent être ajustés en fonction des conditions du site. Si les paramètres ne sont pas réglés correctement, la perte de signal se produira.

Le fait de ne pas suivre les instructions peut entraîner une défaillance de la protection fournie par l'équipement, ce qui peut entraîner des conséquences graves, comme des blessures ou des dommages à l'équipement.

A Dimension drawing

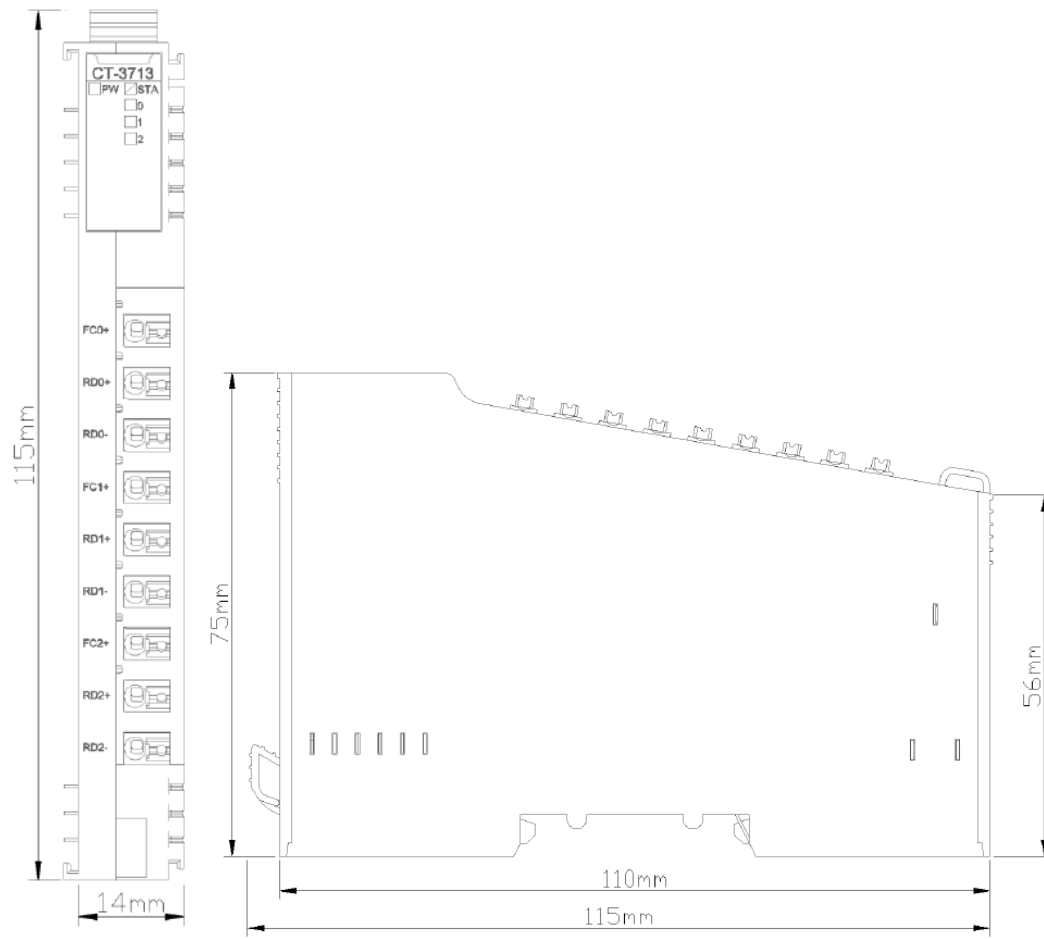

CT-3723 3 channels RTD-PT1000 temperature acquisition module

1 Module features

- ◆ The module supports 3-channel RTD thermal resistance (PT1000) temperature acquisition
- ◆ The module could be connected to a 2-wire or 3-wire PT1000 temperature sensor
- ◆ The internal bus of the module and field input adopts magnetic isolation
- ◆ The module carries with 3 analog input channel LED indicator
- ◆ 15-bits ADC resolution

2 Technical Parameters

General Parameters	
Power	Max.35mA@5.0Vdc
Isolation	I/O to internal bus: magnetic isolation (2.5KVrms)
Field Power	Not used
Wiring	Max.: AWG 18
Mounting Type	35mmDIN-Rail
Size	115*14*75mm
Weight	65g
Environment Specification	
Operating Temperature of Horizontal Installation	-35°C~70°C
Operating Temperature of Vertical Installation	-35°C~60°C
Relative Humidity	< 95%RH (No Condensation)
Storage Temperature	-40°C~85°C
Storage Humidity	< 95%RH (No Condensation)
Manufacturing Test Temperature	-40°C~75°C
Ingress Protection Rating	IP20
Input Parameter	
Channel Number	3 Channels
LED Indicator	3 Green LED
Resolution	15 bits
Sensor Type	PT1000
Measurement Range	-240~870°C
Measurement Accuracy	0.5°C
Conversion Rate	400ms/3 channels
Diagnostic Function	32766: The sensor is not connected or disconnected -32766: Short Circuited 32765: Chip failure 32767: Overflow -32768: Underflow

WARNING

UNEXPECTED EQUIPMENT OPERATION

Do not exceed any of the ratings specified in the environmental and electrical characteristics table.

Failure to follow instructions specified by the manufacturer may result in serious consequences such as death, personal injury, or damage to equipment since the protection provided by the equipment may be impaired.

 **AVERTISSEMENT**

FONCTIONNEMENT INATTENDU DE L'EQUIPEMENT

Ne dépassez aucune évaluation spécifiée dans le tableau de caractéristiques environnementales et électriques..

Le fait de ne pas suivre les instructions peut entraîner une défaillance de la protection fournie par l'équipement, ce qui peut entraîner des conséquences graves, comme des blessures ou des dommages à l'équipement.

3 Hardware Interface

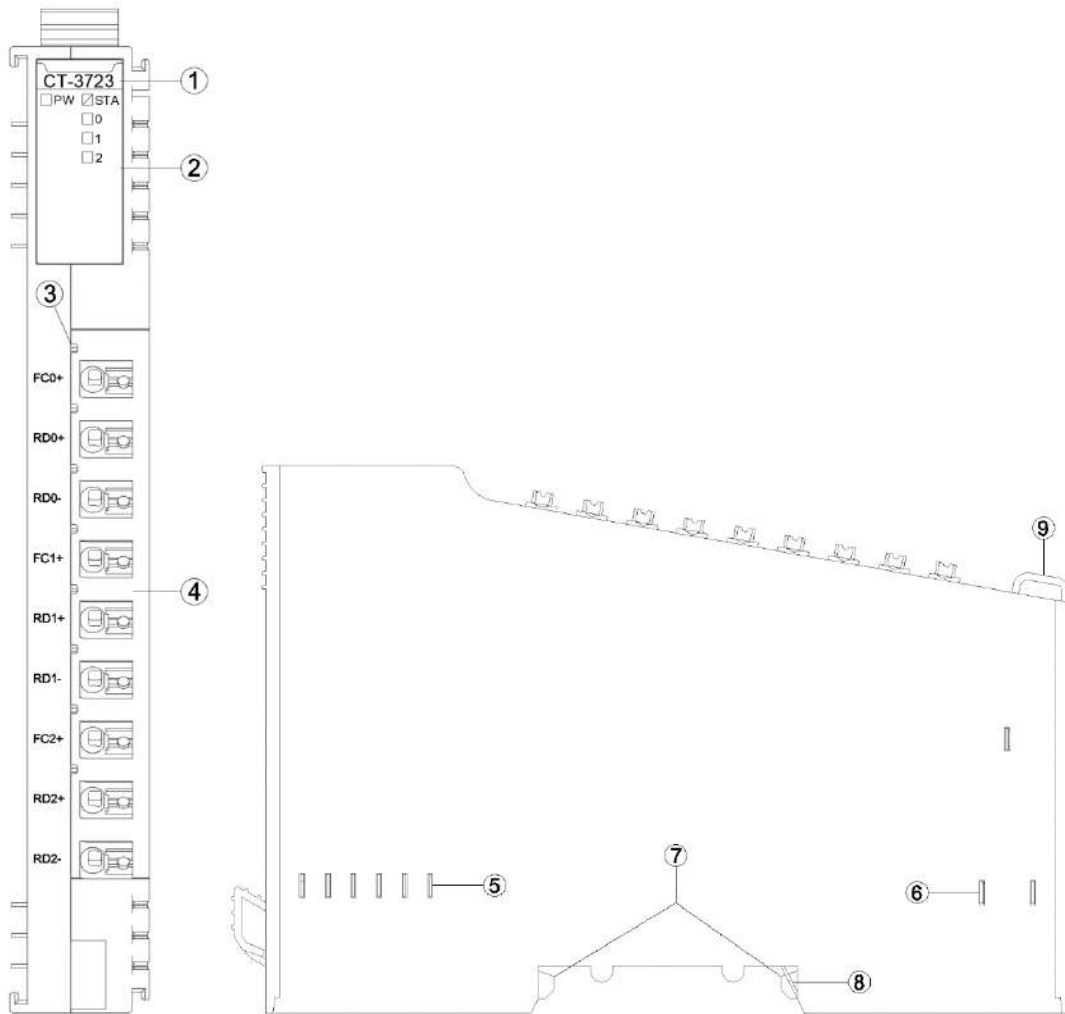

- ① Module Type
- ② State indicator
- ③ N/A
- ④ Wiring Terminal and identification
- ⑤ Internal Bus
- ⑥ Field Power
- ⑦ Buckle
- ⑧ Grounding Spring Sheet
- ⑨ Fixed Wiring Harness

3.1 LED indicator definition

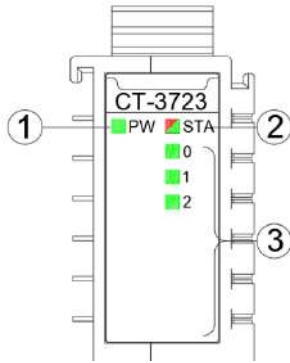

- ① Power LED indicator (green)
- ② Module State LED indicator (red/green)
- ③ Input channel LED indicator (green)

PW POWER STATE (GREEN)	Definition
ON	Internal bus Power Normal
OFF	Internal bus Power Failure
STA MODULE STATE (RED/GREEN)	Definition
Green slow flash (2.5Hz)	Module internal bus is not started
Red slow flash (2.5Hz)	Module internal bus offline
ON (GREEN)	Operation normal
Flash(2.5Hz) (RED/GREEN)	Upgrading mode
Flash(10Hz) (RED/GREEN)	Firmware Update
Double Flash (RED)	Module Exception, has been soft-restarted
0-2 Channel Indicator	Definition
ON	The input signal exceeds 1% of the range
OFF	Invalid input signal

⚠ WARNING

UNEXPECTED EQUIPMENT OPERATION

By viewing the PW indicator, could determine the power supply status of a module. If the PW is steady green, the power supply is normal. Otherwise, the module cannot work properly.

When the module is initially powered on, there will be 3S for the backplane bus connection. After the backplane bus is initialized, STA is in the green steady state. If STA is in the green blinking state, it indicates that the backplane bus has not been initialized, and it needs to be powered off and restarted for re-initialization.

STA abnormal working state occurs during the normal operation of the module, please check the

firmware version information of all modules, and consult ODOT technical support for details.
If a module is upgraded, check that all modules are in the normal state after the upgrade. Otherwise, an exception may occur.

Failure to follow instructions specified by the manufacturer may result in serious consequences such as death, personal injury, or damage to equipment since the protection provided by the equipment may be impaired.

AVERTISSEMENT

FONCTIONNEMENT INATTENDU DE L'EQUIPEMENT

En regardant l'état de l'indicateur de PW, jugez l'état d'alimentation du module. Le feu vert PW reste allumé et l'alimentation est normale. Autrement, le module ne fonctionnera pas correctement.

Lorsque le module est alimenté initialement, il y aura 3S pour la connexion de bus de backboard. STA est un état vert permanent après l'initialisation du bus de backboard. Si STA est en état de clignotement vert, cela signifie que l'initialisation du bus de backboard n'est pas passée et doit être redémarrée hors tension et réinitialisée.

L'état de fonctionnement anormal de STA se produit pendant le fonctionnement normal du module, veuillez vérifier les informations de version du firmware de tous les modules, et consulter le support technique ODOT pour plus de détails.

Si le module a une opération de mise à niveau, après l'achèvement de la mise à niveau, le besoin de vérifier que tous les modules sont dans l'état normal avant de courir, sinon il conduira à une exception.

Le fait de ne pas suivre les instructions peut entraîner une défaillance de la protection fournie par l'équipement, ce qui peut entraîner des conséquences graves, comme des blessures ou des dommages à l'équipement.

3.2 Terminal definition

Terminal Number	Definition	Description
1	FC0+	Signal Input CH0
2	RD0+	
3	RD0-	
4	FC1+	Signal Input CH1
5	RD1+	
6	RD1-	
7	FC2+	Signal Input CH2
8	RD2+	
9	RD2-	

⚠ WARNING

UNEXPECTED EQUIPMENT OPERATION

Calculate the maximum field power current consumption of a single module based on the actual field load. If the total field power current consumption of all I/O modules exceeds the power supply capacity of the field power supply, you must add an extra power expansion module. Otherwise, an output channel exception may occur.

Failure to follow instructions specified by the manufacturer may result in serious consequences such as death, personal injury, or damage to equipment since the protection provided by the equipment may be impaired.

⚠ AVERTISSEMENT

FONCTIONNEMENT INATTENDU DE L'EQUIPEMENT

Calculez la consommation maximale de courant de champ d'un seul module en fonction de la charge de champ réelle. Si la consommation totale de courant de champ de tous les modules d'E/S dépasse la capacité d'alimentation de l'alimentation de champ, vous devez ajouter un module d'extension de puissance supplémentaire. Dans le cas contraire, une exception de canal de sortie peut se produire.

Le fait de ne pas suivre les instructions peut entraîner une défaillance de la protection fournie par l'équipement, ce qui peut entraîner des conséquences graves, comme des blessures ou des dommages à l'équipement.

When connecting a cold-pressed terminal, the terminal must be terminated and checked in strict accordance with the corresponding termination specifications or requirements, and connect the cold-pressed terminal according to the corresponding node serial number. The conductor should use copper conductor and the conductor core should be larger than 0.2mm^2 and smaller than 1mm^2 (AWG18~AWG24). Cold-pressed terminal parameters are as follows:

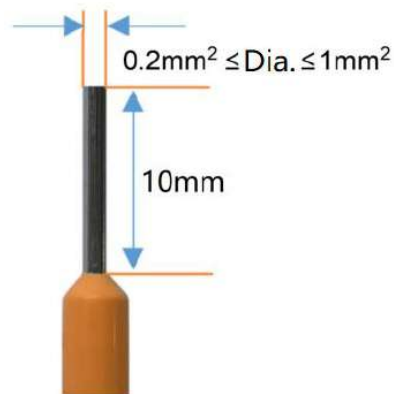

WARNING

UNEXPECTED EQUIPMENT OPERATION

Strip the length of the conductor insulation layer is greater than 10mm to ensure reliable signal connection.

The wire needs to use copper wire and the wire core is greater than or equal to 0.2mm² and less than or equal to 1mm² to ensure reliable signal connection.

When connecting a cold-press terminal, connect the cold-press terminal strictly in accordance with the corresponding termination specifications or requirements, and connect the cold-press terminal according to the corresponding node serial number.

Do not power on cold-press terminals until they are properly connected or fully locked.

Failure to follow instructions specified by the manufacturer may result in serious consequences such as death, personal injury, or damage to equipment since the protection provided by the equipment may be impaired.

AVERTISSEMENT

FONCTIONNEMENT INATTENDU DE L'ÉQUIPEMENT

Dépouillez la longueur de la couche isolante du fil plus de 10mm pour assurer la connexion fiable du signal.

Le conducteur doit utiliser le fil de cuivre et le noyau de fil est supérieur ou égal à 0,2 mm², inférieur ou égal à 1mm², afin d'assurer la connexion fiable du signal.

Lorsque les terminaux de presse à froid sont terminés, ils doivent être terminés et visualisés en stricte conformité avec les spécifications ou les exigences correspondantes et terminés selon le numéro de série de noeud correspondant.

Il est interdit d'activer les bornes à froid avant qu'elles ne soient correctement articulées ou complètement verrouillées.

Le fait de ne pas suivre les instructions peut entraîner une défaillance de la protection fournie par l'équipement, ce qui peut entraîner des conséquences graves, comme des blessures ou des dommages à l'équipement.

DANGER

FIRE DANGER

Use the correct wiring rules only for the maximum current capacity of the I/O channel and power supply.

Failure to follow instructions specified by the manufacturer may result in serious consequences such as death, personal injury, or damage to equipment since the protection provided by the equipment may be impaired.

 **WARNING**

UNEXPECTED EQUIPMENT OPERATION

Do not exceed any of the ratings specified in the environmental and electrical characteristics table.

Failure to follow instructions specified by the manufacturer may result in serious consequences such as death, personal injury, or damage to equipment since the protection provided by the equipment may be impaired.

 **AVERTISSEMENT**

FONCTIONNEMENT INATTENDU DE L'EQUIPEMENT

Ne dépassez aucune évaluation spécifiée dans le tableau de caractéristiques environnementales et électriques..

Le fait de ne pas suivre les instructions peut entraîner une défaillance de la protection fournie par l'équipement, ce qui peut entraîner des conséquences graves, comme des blessures ou des dommages à l'équipement.

4 Wiring

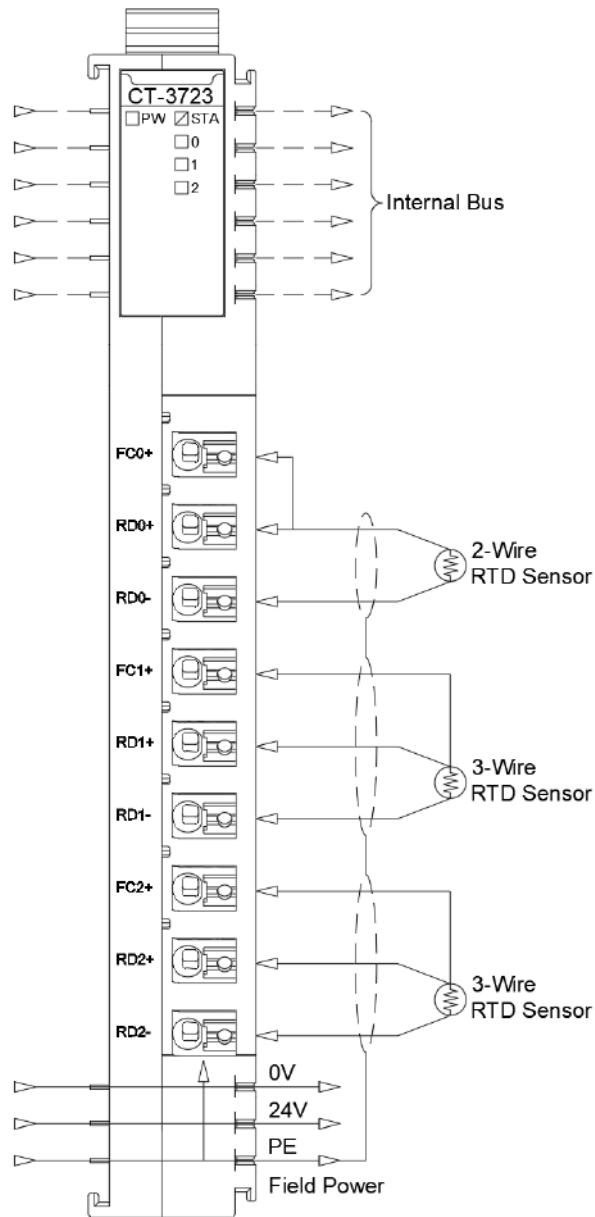

NOTE

EQUIPMENT INOPERABLE

Do not crimp the spring terminal with more than the maximum pressure specified for the terminal. Otherwise, the resilience of the spring terminal may be damaged and the terminal rebound may be affected.

Do not press the spring terminal with a sharp tool when removing cable from the channel. Otherwise, the spring terminal will be damaged.

Failure to follow these instructions may result in equipment damage.

5 Process data definition

Input Data								
Bit No	Bit 7	Bit 6	Bit 5	Bit 4	Bit 3	Bit 2	Bit 1	Bit 0
Byte 0	Analog Input Data (CH 0)							
Byte 1								
Byte 2	Analog Input Data (CH 1)							
Byte 3								
Byte 4	Analog Input Data (CH 2)							
Byte 5								

Data description:

Analog Input Data (CH0-2): Analog channel input data values

Process Data Definition			
Temperature	Decimal	Hex	Location
>870.0	32767	7FFF	Overflow
>870.0	32766	7FFE	Channel break
>870.0	32765	7FFD	ADC Chip fault
>870.0	32764	7FFC	Overvoltage and undervoltage fault
>870.0	32763	7FFB	ADC Conversion fault
870.0	8800	2260	Exceeds the upper limit
.	.	.	
.	.	.	
850.1	8501	2135	Rated range
850.0	8500	2134	
.	.	.	
.	.	.	
-200.0	-2000	F830	Exceeds the lower limit
-200.1	-2001	F82F	
.	.	.	
.	.	.	
-240.0	-2400	F6A0	Channel disable
<-240.0	-32767	7FFF	
<-240.0	-32768	8000	Underflow

6 Configuration parameters definition

Configuration Parameter								
Bit No	Bit 7	Bit 6	Bit 5	Bit 4	Bit 3	Bit 2	Bit 1	Bit 0
Byte 0	Reserved		Channel Enable (CH 2)	Channel Enable (CH 1)	Channel Enable (CH 0)	Temperature Unit		16Bit Data Format
Byte 1	Filter frequency (CH 0)							
Byte 2	Filter frequency (CH 1)							
Byte 3	Filter frequency (CH 2)							
Byte 4 - Byte 8	Reserved							

Data description:

16Bit Data Format: Sequence of 16-bit data byte transmission (Default: 0)

0: A_B

1: B_A

Temperature Unit: Temperature unit. Celsius, Fahrenheit, Kelvin is optional.

(Default: 0)

0: °C

1: °F

2: K-

Channel Enable(CH 0~CH 5): Channel enable, disable and enable are optional.

(Default: 1)

0: Disable

1: Enable

Filter frequency(CH 0~CH5): Filter frequency,1-31 can be set (Defaul:10)

WARNING

UNEXPECTED EQUIPMENT OPERATION

The filtering parameters could be adjusted according to the field conditions. If the parameter settings are inappropriate, the signal will be lost.

Failure to follow instructions specified by the manufacturer may result in serious consequences such as death, personal injury, or damage to equipment since the protection

provided by the equipment may be impaired.

 **AVERTISSEMENT**

FONCTIONNEMENT INATTENDU DE L'EQUIPEMENT

Les paramètres de filtrage peuvent être ajustés en fonction des conditions du site. Si les paramètres ne sont pas réglés correctement, la perte de signal se produira.

Le fait de ne pas suivre les instructions peut entraîner une défaillance de la protection fournie par l'équipement, ce qui peut entraîner des conséquences graves, comme des blessures ou des dommages à l'équipement.

A Dimension drawing

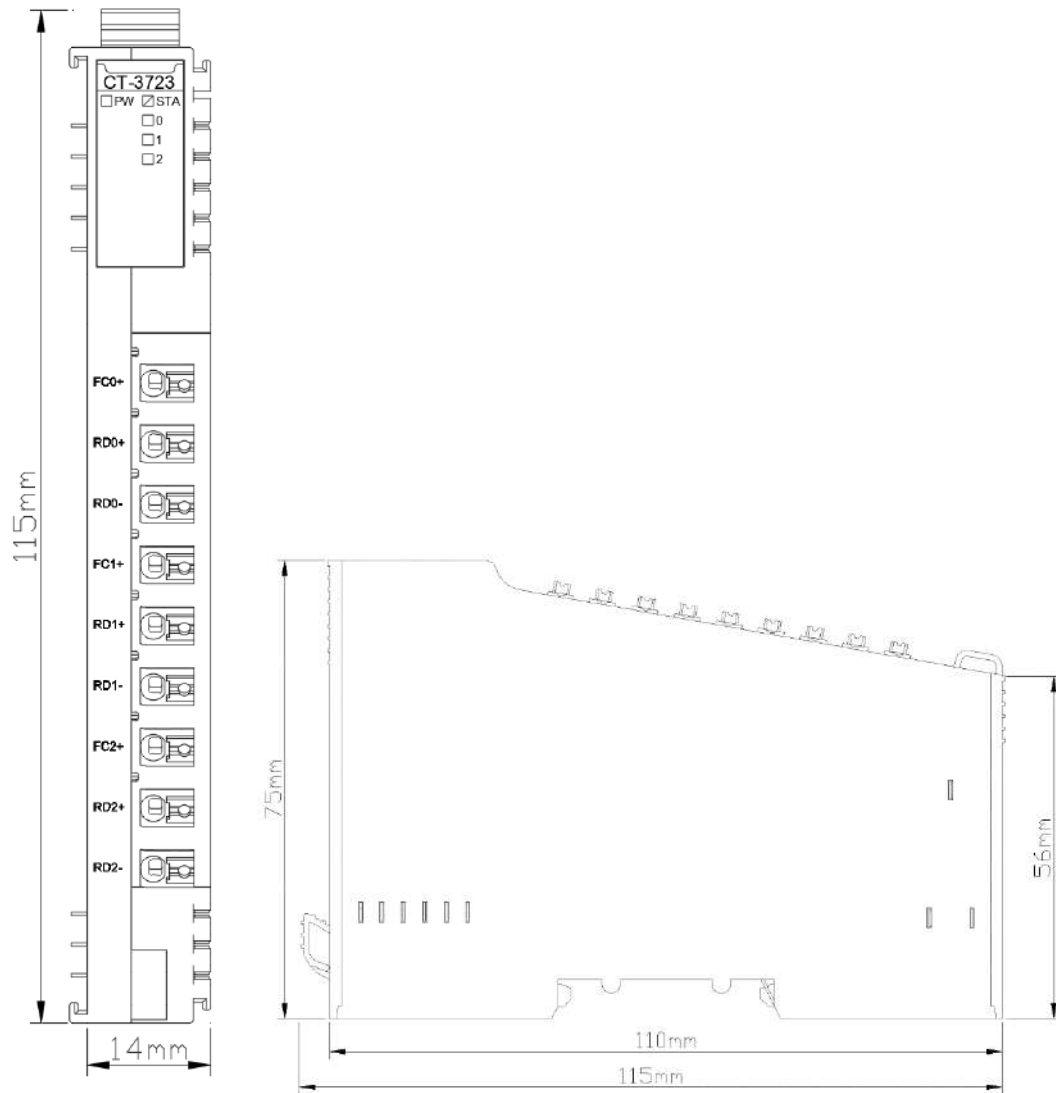

CT-3716 6-channel RTD-PT100 Temperature Acquisition Module

1 Module features

- ◆ The module supports 6-channel RTD thermal resistance (PT100) temperature acquisition
- ◆ The module can be connected to 2-wire or 3-wire PT100 temperature sensor
- ◆ The internal bus and field input of the module are magnetically isolated
- ◆ The module with 6 analog input channel LED indicators
- ◆ 15-bit ADC resolution

2 Technical Parameters

General Parameters	
Power Consumption	Max.50mA@5.0VDC
Isolation	I/O to Internal Bus: Magnetically Isolated (2.5KVrms)
Field Power	Unused
Wiring	Max.: AWG 18
Installation Mode	35mm DIN-Rail
Size	115*14*75mm
Weight	65g
Environment Specification	
Operating Temperature of Horizontal Installation	-35°C~70°C
Operating Temperature of Vertical Installation	-35°C~60°C
Relative Humidity	< 95%RH(No Condensation)
Storage Temperature	-40°C~85°C
Storage Humidity	< 95%RH(No Condensation)
Manufacturing Test Temperature	-40°C~75°C
Ingress Protection Rating	IP20
Input Parameters	
Channel Number	6 channels
LED Indicator	6 green LED
Resolution	15 bits
Sensor Type	PT100
Measuring Range	-240~870°C
Measurement Accuracy	0.5°C
Conversion Rate	400ms/6 channels
Diagnostic Function	32766: The sensor is not connected or the wire is disconnected -32766: Short-circuit condition 32765: Chip failure 32767: Temperature overflow -32768: Temperature underflow

WARNING

UNEXPECTED EQUIPMENT OPERATION

Do not exceed any of the ratings specified in the environmental and electrical characteristics table.

Failure to follow instructions specified by the manufacturer may result in serious consequences such as death, personal injury, or damage to equipment since the protection provided by the equipment may be impaired.

 **AVERTISSEMENT**

FONCTIONNEMENT INATTENDU DE L'EQUIPEMENT

Ne dépassez aucune évaluation spécifiée dans le tableau de caractéristiques environnementales et électriques..

Le fait de ne pas suivre les instructions peut entraîner une défaillance de la protection fournie par l'équipement, ce qui peut entraîner des conséquences graves, comme des blessures ou des dommages à l'équipement.

3 Hardware interface

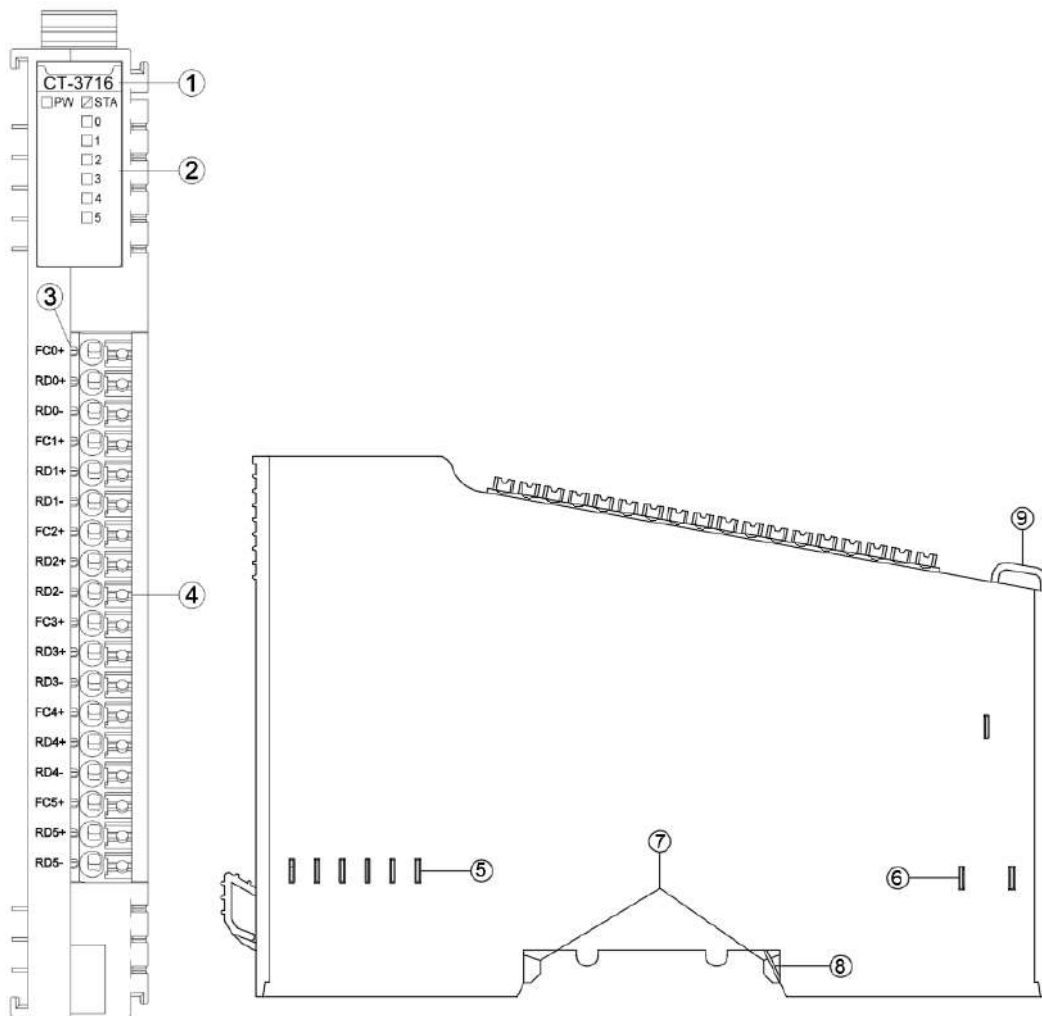

- ① Module Type
- ② State indicator
- ③ N/A
- ④ Wiring Terminal and identification
- ⑤ Internal Bus
- ⑥ Field Power
- ⑦ Buckle
- ⑧ Grounding Spring Sheet
- ⑨ Fixed Wiring Harness

3.1 LED Indicator Definition

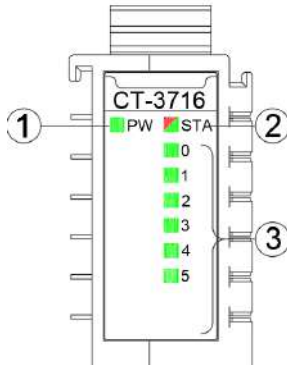

- ① Power LED indicator (green)
- ② Module State LED indicator (red/green)
- ③ Input channel LED indicator (green)

PW power state (GREEN)	Definition
ON	The internal bus power supply is normal
OFF	The internal bus power supply is abnormal
STA module state (RED/GREEN)	Definition
Green Slow Flashing (2.5Hz)	The module's internal bus is not started
Red Slow Flashing (2.5Hz)	The internal bus of the module is offline
On (GREEN)	Operation normal
Flash(2.5Hz) (RED/GREEN)	Upgrading mode
Flash(10Hz) (RED/GREEN)	Firmware Update
Double Flash (RED)	Module exception and program has been soft-restarted
0-5 channel indicator (GREEN)	Definition
ON	The input signal exceeds 1% of the range
OFF	The input signal is invalid

⚠ WARNING

UNEXPECTED EQUIPMENT OPERATION

By viewing the PW indicator, could determine the power supply status of a module. If the PW is steady green, the power supply is normal. Otherwise, the module cannot work properly.

When the module is initially powered on, there will be 3S for the backplane bus connection. After the backplane bus is initialized, STA is in the green steady state. If STA is in the green blinking state, it indicates that the backplane bus has not been initialized, and it needs to be powered off and restarted for re-initialization.

STA abnormal working state occurs during the normal operation of the module, please check the

firmware version information of all modules, and consult ODOT technical support for details.
 If a module is upgraded, check that all modules are in the normal state after the upgrade.
 Otherwise, an exception may occur.

Failure to follow instructions specified by the manufacturer may result in serious consequences such as death, personal injury, or damage to equipment since the protection provided by the equipment may be impaired.

AVERTISSEMENT

FONCTIONNEMENT INATTENDU DE L'ÉQUIPEMENT

En regardant l'état de l'indicateur de PW, jugez l'état d'alimentation du module. Le feu vert PW reste allumé et l'alimentation est normale. Autrement, le module ne fonctionnera pas correctement.

Lorsque le module est alimenté initialement, il y aura 3S pour la connexion de bus de backboard. STA est un état vert permanent après l'initialisation du bus de backboard. Si STA est en état de clignotement vert, cela signifie que l'initialisation du bus de backboard n'est pas passée et doit être redémarrée hors tension et réinitialisée.

L'état de fonctionnement anormal de STA se produit pendant le fonctionnement normal du module, veuillez vérifier les informations de version du firmware de tous les modules, et consulter le support technique ODOT pour plus de détails.

Si le module a une opération de mise à niveau, après l'achèvement de la mise à niveau, le besoin de vérifier que tous les modules sont dans l'état normal avant de courir, sinon il conduira à une exception.

Le fait de ne pas suivre les instructions peut entraîner une défaillance de la protection fournie par l'équipement, ce qui peut entraîner des conséquences graves, comme des blessures ou des dommages à l'équipement.

3.2 Terminal definition

Terminal serial number	definition	illustrate
1	FC0+	The signal input is CH0
2	RD0+	
3	RD0-	
4	FC1+	The signal input is CH1
5	RD1+	
6	RD1-	
7	FC2+	The signal input is CH2
8	RD2+	

9	RD2-	
10	FC3+	The signal input is CH3
11	RD3+	
12	RD3-	
13	FC4+	The signal input is CH4
14	RD4+	
15	RD4-	
16	FC5+	The signal input is CH5
17	RD5+	
18	RD5-	

 WARNING

UNEXPECTED EQUIPMENT OPERATION

Calculate the maximum field power current consumption of a single module based on the actual field load. If the total field power current consumption of all I/O modules exceeds the power supply capacity of the field power supply, you must add an extra power expansion module. Otherwise, an output channel exception may occur.

Failure to follow instructions specified by the manufacturer may result in serious consequences such as death, personal injury, or damage to equipment since the protection provided by the equipment may be impaired.

 AVERTISSEMENT

FONCTIONNEMENT INATTENDU DE L'EQUIPEMENT

Calculez la consommation maximale de courant de champ d'un seul module en fonction de la charge de champ réelle. Si la consommation totale de courant de champ de tous les modules d'E/S dépasse la capacité d'alimentation de l'alimentation de champ, vous devez ajouter un module d'extension de puissance supplémentaire. Dans le cas contraire, une exception de canal de sortie peut se produire.

Le fait de ne pas suivre les instructions peut entraîner une défaillance de la protection fournie par l'équipement, ce qui peut entraîner des conséquences graves, comme des blessures ou des dommages à l'équipement.

When connecting a cold-pressed terminal, the terminal must be terminated and checked in strict accordance with the corresponding termination specifications or requirements, and connect the cold-pressed terminal according to the corresponding node serial number. The conductor should use copper conductor and the conductor

core should be larger than 0.2mm² and smaller than 1mm² (AWG18~AWG24). Cold-pressed terminal parameters are as follows:

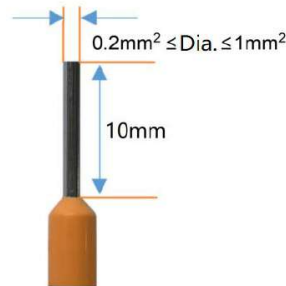

WARNING

UNEXPECTED EQUIPMENT OPERATION

Strip the length of the conductor insulation layer is greater than 10mm to ensure reliable signal connection.

The wire needs to use copper wire and the wire core is greater than or equal to 0.2mm² and less than or equal to 1mm² to ensure reliable signal connection.

When connecting a cold-press terminal, connect the cold-press terminal strictly in accordance with the corresponding termination specifications or requirements, and connect the cold-press terminal according to the corresponding node serial number.

Do not power on cold-press terminals until they are properly connected or fully locked.

Failure to follow instructions specified by the manufacturer may result in serious consequences such as death, personal injury, or damage to equipment since the protection provided by the equipment may be impaired.

AVERTISSEMENT

FONCTIONNEMENT INATTENDU DE L'EQUIPEMENT

Dépouillez la longueur de la couche isolante du fil plus de 10mm pour assurer la connexion fiable du signal.

Le conducteur doit utiliser le fil de cuivre et le noyau de fil est supérieur ou égal à 0,2 mm², inférieur ou égal à 1mm², afin d'assurer la connexion fiable du signal.

Lorsque les terminaux de presse à froid sont terminés, ils doivent être terminés et visualisés en stricte conformité avec les spécifications ou les exigences correspondantes et terminés selon le numéro de série de noeud correspondant.

Il est interdit d'activer les bornes à froid avant qu'elles ne soient correctement articulées ou complètement verrouillées.

Le fait de ne pas suivre les instructions peut entraîner une défaillance de la protection fournie par l'équipement, ce qui peut entraîner des conséquences graves, comme des blessures ou des dommages à l'équipement.

DANGER

FIRE DANGER

Use the correct wiring rules only for the maximum current capacity of the I/O channel and power supply.

Failure to follow instructions specified by the manufacturer may result in serious consequences such as death, personal injury, or damage to equipment since the protection provided by the equipment may be impaired.

WARNING

UNEXPECTED EQUIPMENT OPERATION

Do not exceed any of the ratings specified in the environmental and electrical characteristics table.

Failure to follow instructions specified by the manufacturer may result in serious consequences such as death, personal injury, or damage to equipment since the protection provided by the equipment may be impaired.

AVERTISSEMENT

FONCTIONNEMENT INATTENDU DE L'EQUIPEMENT

Ne dépassez aucune évaluation spécifiée dans le tableau de caractéristiques environnementales et électriques..

Le fait de ne pas suivre les instructions peut entraîner une défaillance de la protection fournie par l'équipement, ce qui peut entraîner des conséquences graves, comme des blessures ou des dommages à l'équipement.

4 Wiring

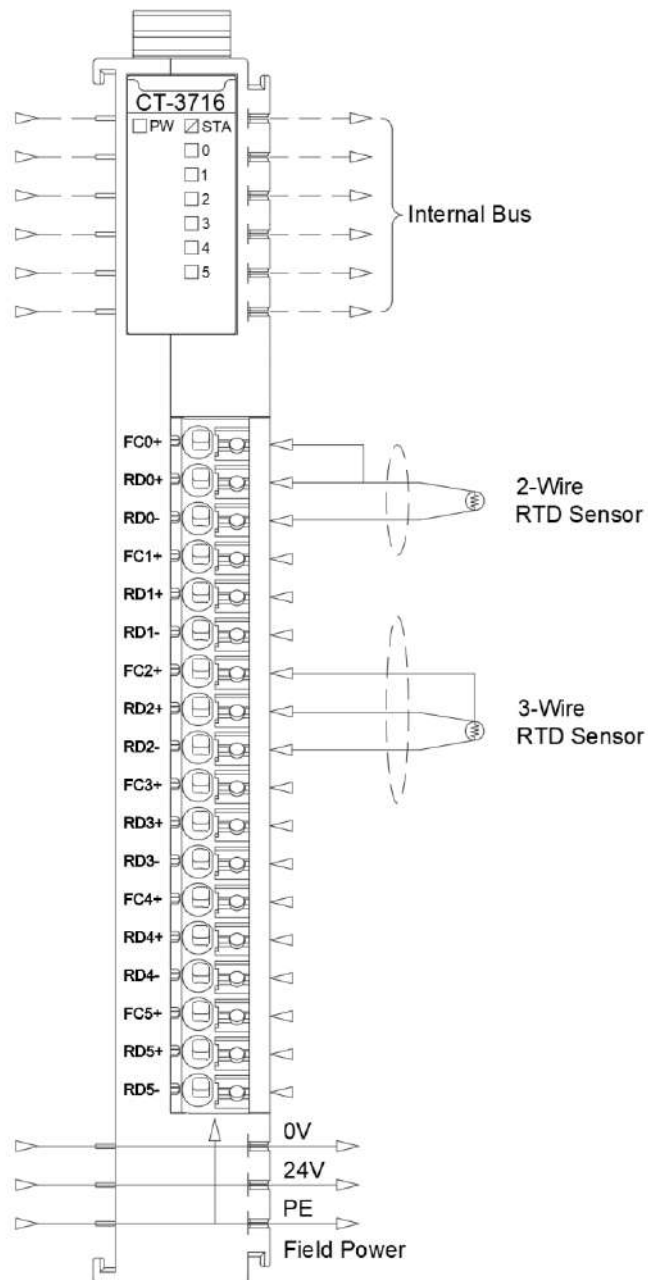

NOTICE

EQUIPMENT INOPERABLE

Do not crimp the spring terminal with more than the maximum pressure specified for the terminal. Otherwise, the resilience of the spring terminal may be damaged and the terminal rebound may be affected.

Do not press the spring terminal with a sharp tool when removing cable from the channel. Otherwise, the spring terminal will be damaged.

Failure to follow these instructions may result in equipment damage.

5 Process data definition

Input data								
Bit No	Bit 7	Bit 6	Bit 5	Bit 4	Bit 3	Bit 2	Bit 1	Bit 0
Byte 0	Analog Input Data(CH 0)							
Byte 1								
Byte 2	Analog Input Data(CH 1)							
Byte 3								
Byte 4	Analog Input Data(CH 2)							
Byte 5								
Byte 6	Analog Input Data(CH 3)							
Byte 7								
Byte 8	Analog Input Data(CH 4)							
Byte 9								
Byte 10	Analog Input Data(CH 5)							
Byte 11								

Data Description:

Analog Input Data (CH0-5): The value of the analog channel input data.

Process data definition			
Temperature	Decimal	Hexadecimal	Location
>880.0	32767	7FFF	Upflow
>880.0	32766	7FFE	Channel break
>880.0	32765	7FFD	ADC chip fault
>880.0	32764	7FFC	Overvoltage and undervoltage faults
>880.0	32763	7FFB	ADC conversion exception
880.0	8800	2260	Exceeding the upper limit
.	.	.	
.	.	.	
850.1	8501	2135	Rated range
850.0	8500	2134	
.	.	.	
.	.	.	
-200.0	-2000	F830	Lower limit exceeded
-200.1	-2001	F82F	
.	.	.	

.	.	.	
-240.0	-2400	F6A0	
<-240.0	-32767	7FFF	Channel disable
<-240.0	-32768	8000	underflow

6 Configuration parameter definition

配置参数								
Bit No	Bit 7	Bit 6	Bit 5	Bit 4	Bit 3	Bit 2	Bit 1	Bit 0
Byte 0	Reserved					Temperature Unit		16Bit Data Format
Byte 1	Reserved		Channel Enable (CH 5)	Channel Enable (CH 4)	Channel Enable (CH 3)	Channel Enable (CH 2)	Channel Enable (CH 1)	Channel Enable (CH 0)
Byte 2	CH0 Filter Level							
Byte 3	CH1 Filter Level							
Byte 4	CH2 Filter Level							
Byte 5	CH3 Filter Level							
Byte 6	CH4 Filter Level							
Byte 7	CH5 Filter Level							
Byte 8 - Byte 12	Reserved							

Data Description:

16Bit Data Format: 16-bit data byte transfer order. (Default: 0).

0: A_B

1: B_A

Temperature Unit: The unit of temperature. Degrees Celsius, Fahrenheit, Kelvin are optional. (Default: 0).

0: °C

1: °F

2: K

Channel Enable (CH 0): Channel Enable, Disable or Enable is optional. (Default: 1).

0: Disable

1: Enable

CH0 Filter Level: Filter level, grade 1~7 optional. (Default: 4).

1: Level 1

2: Level 2

3: Level 3

4: Level 4

5: Level 5

6: Level 6

7: Level 7

 **WARNING**

UNEXPECTED EQUIPMENT OPERATION

The filtering parameters could be adjusted according to the field conditions. If the parameter settings are inappropriate, the signal will be lost.

Failure to follow instructions specified by the manufacturer may result in serious consequences such as death, personal injury, or damage to equipment since the protection provided by the equipment may be impaired.

 **AVERTISSEMENT**

FONCTIONNEMENT INATTENDU DE L'EQUIPEMENT

Les paramètres de filtrage peuvent être ajustés en fonction des conditions du site. Si les paramètres ne sont pas réglés correctement, la perte de signal se produira.

Le fait de ne pas suivre les instructions peut entraîner une défaillance de la protection fournie par l'équipement, ce qui peut entraîner des conséquences graves, comme des blessures ou des dommages à l'équipement.

A Dimensional drawing

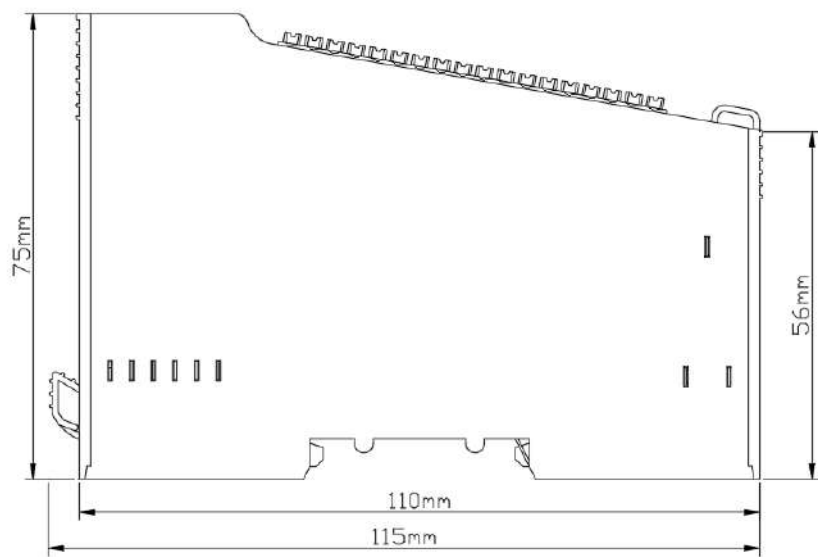
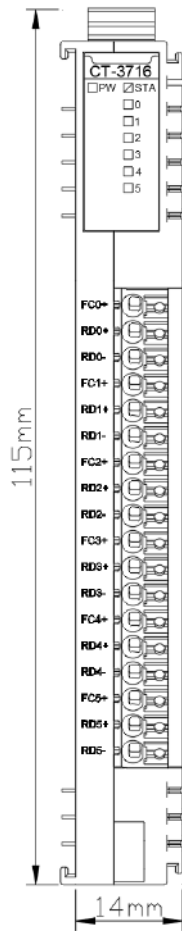

CT-3726 6-channel RTD-PT1000 Temperature Acquisition Module

1 Module features

- ◆ The module supports 6-channel RTD thermal resistance(PT1000) temperature acquisition
- ◆ The module can be connected to 2-wire or 3-wire PT1000 temperature sensor
- ◆ The internal bus and field input of the module are magnetically isolated
- ◆ The module with 6 analog input channel LED indicators
- ◆ 15-bit ADC resolution

2 Technical Parameters

General Parameters	
Power Consumption	Max.50mA@5.0VDC
Isolation	I/O to Internal Bus: Magnetically Isolated (2.5KVrms)
Field Power	Unused
Wiring	Max.: AWG 18
Installation mode	35mm DIN-Rail
Size	115*14*75mm
Weight	65g
Environment Specification	
Operating Temperature of Horizontal Installation	-35°C~70°C
Operating Temperature of Vertical Installation	-35°C~60°C
Relative Humidity	< 95%RH(No Condensation)
Storage Temperature	-40°C~85°C
Storage Humidity	< 95%RH(No Condensation)
Manufacturing Test Temperature	-40°C~75°C
Ingress Protection Rating	IP20
Enter the parameters	
Channel Number	6 channels
LED Indicator	6 green LED
Resolution	15 bits
Sensor Type	PT1000
Measuring Range	-240~870°C
Measurement Accuracy	0.5°C
Conversion Rate	400ms/6 channels
Diagnostic Function	32766: The sensor is not connected or the wire is disconnected -32766: Short-circuit condition 32765: Chip failure 32767: Temperature overflow -32768: Temperature underflow

WARNING

UNEXPECTED EQUIPMENT OPERATION

Do not exceed any of the ratings specified in the environmental and electrical characteristics table.

Failure to follow instructions specified by the manufacturer may result in serious consequences such as death, personal injury, or damage to equipment since the protection provided by the equipment may be impaired.

AVERTISSEMENT

FONCTIONNEMENT INATTENDU DE L'EQUIPEMENT

Ne dépassez aucune évaluation spécifiée dans le tableau de caractéristiques environnementales et électriques..

Le fait de ne pas suivre les instructions peut entraîner une défaillance de la protection fournie par l'équipement, ce qui peut entraîner des conséquences graves, comme des blessures ou des dommages à l'équipement.

3 Hardware interface

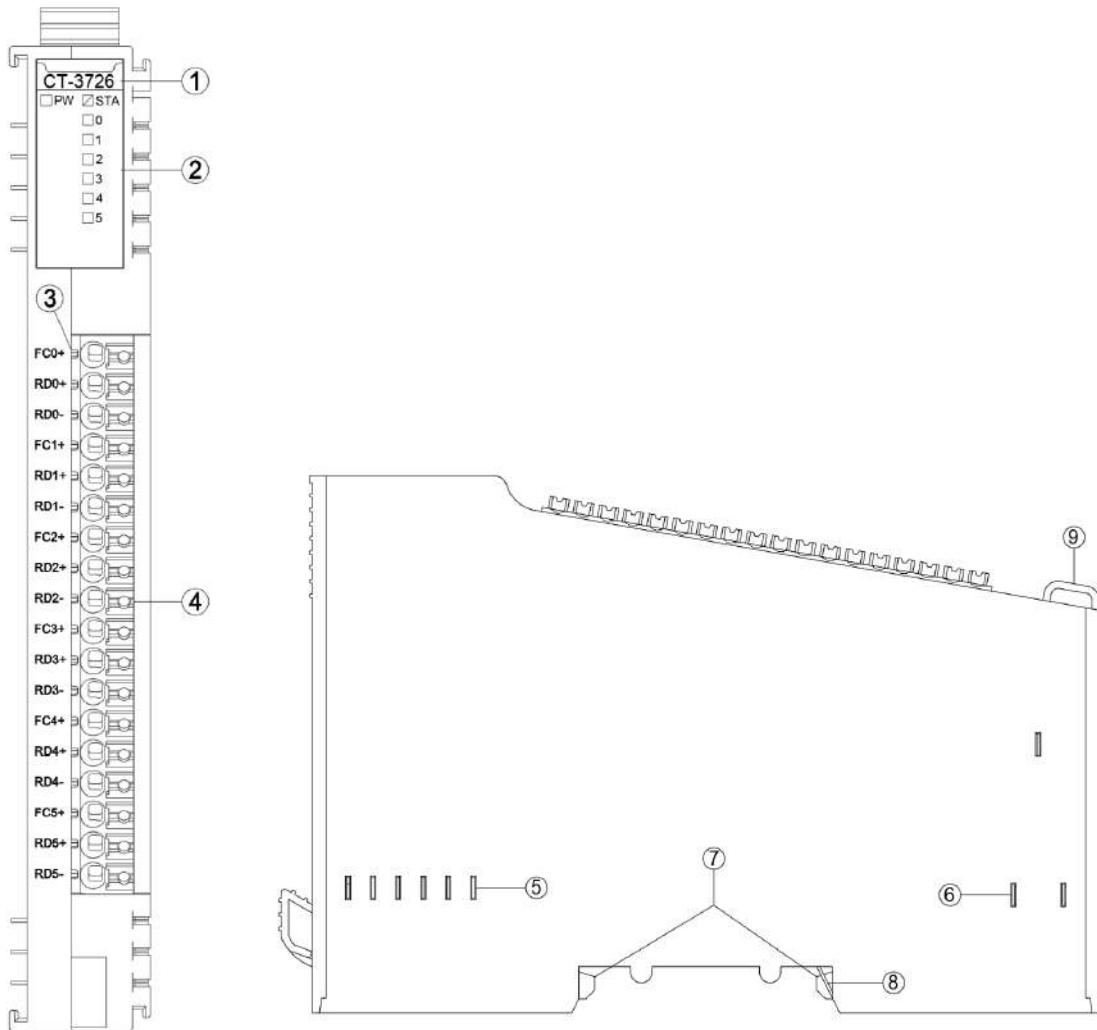

- ① Module Type
- ② State indicator
- ③ N/A
- ④ Wiring Terminal and identification
- ⑤ Internal Bus
- ⑥ Field Power
- ⑦ Buckle
- ⑧ Grounding Spring Sheet
- ⑨ Fixed Wiring Harness

3.1 LED Indicator Definition

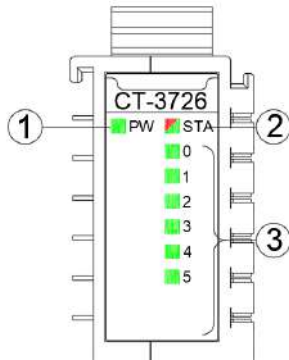

- ① Power LED indicator (green)
- ② Module State LED indicator (red/green)
- ③ Input channel LED indicator (green)

PW power state (GREEN)	Definition
ON	The internal bus power supply is normal
OFF	The internal bus power supply is abnormal
STA module state (RED/GREEN)	Definition
Green Slow Flashing (2.5Hz)	The module's internal bus is not started
Red Slow Flashing (2.5Hz)	The internal bus of the module is offline
On (GREEN)	Operation normal
Flash(2.5Hz) (RED/GREEN)	Upgrading mode
Flash(10Hz) (RED/GREEN)	Firmware Update
Double Flash (RED)	Module exception and program has been soft-restarted
0-5 channel indicator (GREEN)	Definition
ON	The input signal exceeds 1% of the range
OFF	The input signal is invalid

! WARNING

UNEXPECTED EQUIPMENT OPERATION

By viewing the PW indicator, could determine the power supply status of a module. If the PW is steady green, the power supply is normal. Otherwise, the module cannot work properly.

When the module is initially powered on, there will be 3S for the backplane bus connection. After the backplane bus is initialized, STA is in the green steady state. If STA is in the green blinking state, it indicates that the backplane bus has not been initialized, and it needs to be powered off and restarted for re-initialization.

STA abnormal working state occurs during the normal operation of the module, please check the

firmware version information of all modules, and consult ODOT technical support for details.
If a module is upgraded, check that all modules are in the normal state after the upgrade. Otherwise, an exception may occur.

Failure to follow instructions specified by the manufacturer may result in serious consequences such as death, personal injury, or damage to equipment since the protection provided by the equipment may be impaired.

AVERTISSEMENT

FONCTIONNEMENT INATTENDU DE L'ÉQUIPEMENT

En regardant l'état de l'indicateur de PW, jugez l'état d'alimentation du module. Le feu vert PW reste allumé et l'alimentation est normale. Autrement, le module ne fonctionnera pas correctement.

Lorsque le module est alimenté initialement, il y aura 3S pour la connexion de bus de backboard. STA est un état vert permanent après l'initialisation du bus de backboard. Si STA est en état de clignotement vert, cela signifie que l'initialisation du bus de backboard n'est pas passée et doit être redémarrée hors tension et réinitialisée.

L'état de fonctionnement anormal de STA se produit pendant le fonctionnement normal du module, veuillez vérifier les informations de version du firmware de tous les modules, et consulter le support technique ODOT pour plus de détails.

Si le module a une opération de mise à niveau, après l'achèvement de la mise à niveau, le besoin de vérifier que tous les modules sont dans l'état normal avant de courir, sinon il conduira à une exception.

Le fait de ne pas suivre les instructions peut entraîner une défaillance de la protection fournie par l'équipement, ce qui peut entraîner des conséquences graves, comme des blessures ou des dommages à l'équipement.

3.2 Terminal definition

Terminal serial number	definition	illustrate
1	FC0+	The signal input is CH0
2	RD0+	
3	RD0-	
4	FC1+	The signal input is CH1
5	RD1+	
6	RD1-	
7	FC2+	The signal input is CH2
8	RD2+	

9	RD2-	
10	FC3+	The signal input is CH3
11	RD3+	
12	RD3-	
13	FC4+	The signal input is CH4
14	RD4+	
15	RD4-	
16	FC5+	The signal input is CH5
17	RD5+	
18	RD5-	

WARNING

UNEXPECTED EQUIPMENT OPERATION

Calculate the maximum field power current consumption of a single module based on the actual field load. If the total field power current consumption of all I/O modules exceeds the power supply capacity of the field power supply, you must add an extra power expansion module. Otherwise, an output channel exception may occur.

Failure to follow instructions specified by the manufacturer may result in serious consequences such as death, personal injury, or damage to equipment since the protection provided by the equipment may be impaired.

AVERTISSEMENT

FONCTIONNEMENT INATTENDU DE L'EQUIPEMENT

Calculez la consommation maximale de courant de champ d'un seul module en fonction de la charge de champ réelle. Si la consommation totale de courant de champ de tous les modules d'E/S dépasse la capacité d'alimentation de l'alimentation de champ, vous devez ajouter un module d'extension de puissance supplémentaire. Dans le cas contraire, une exception de canal de sortie peut se produire.

Le fait de ne pas suivre les instructions peut entraîner une défaillance de la protection fournie par l'équipement, ce qui peut entraîner des conséquences graves, comme des blessures ou des dommages à l'équipement.

When connecting a cold-pressed terminal, the terminal must be terminated and checked in strict accordance with the corresponding termination specifications or requirements, and connect the cold-pressed terminal according to the corresponding node serial number. The conductor should use copper conductor and the conductor

core should be larger than 0.2mm² and smaller than 1mm² (AWG18~AWG24). Cold-pressed terminal parameters are as follows:



⚠️ WARNING

UNEXPECTED EQUIPMENT OPERATION

Strip the length of the conductor insulation layer is greater than 10mm to ensure reliable signal connection.

The wire needs to use copper wire and the wire core is greater than or equal to 0.2mm² and less than or equal to 1mm² to ensure reliable signal connection.

When connecting a cold-press terminal, connect the cold-press terminal strictly in accordance with the corresponding termination specifications or requirements, and connect the cold-press terminal according to the corresponding node serial number.

Do not power on cold-press terminals until they are properly connected or fully locked.

Failure to follow instructions specified by the manufacturer may result in serious consequences such as death, personal injury, or damage to equipment since the protection provided by the equipment may be impaired.

⚠️ AVERTISSEMENT

FONCTIONNEMENT INATTENDU DE L'EQUIPEMENT

Dépouillez la longueur de la couche isolante du fil plus de 10mm pour assurer la connexion fiable du signal.

Le conducteur doit utiliser le fil de cuivre et le noyau de fil est supérieur ou égal à 0,2 mm², inférieur ou égal à 1mm², afin d'assurer la connexion fiable du signal.

Lorsque les terminaux de presse à froid sont terminés, ils doivent être terminés et visualisés en stricte conformité avec les spécifications ou les exigences correspondantes et terminés selon le numéro de série de noeud correspondant.

Il est interdit d'activer les bornes à froid avant qu'elles ne soient correctement articulées ou complètement verrouillées.

Le fait de ne pas suivre les instructions peut entraîner une défaillance de la protection fournie par l'équipement, ce qui peut entraîner des conséquences graves, comme des

blessures ou des dommages à l'équipement.

DANGER

FIRE DANGER

Use the correct wiring rules only for the maximum current capacity of the I/O channel and power supply.

Failure to follow instructions specified by the manufacturer may result in serious consequences such as death, personal injury, or damage to equipment since the protection provided by the equipment may be impaired.

WARNING

UNEXPECTED EQUIPMENT OPERATION

Do not exceed any of the ratings specified in the environmental and electrical characteristics table.

Failure to follow instructions specified by the manufacturer may result in serious consequences such as death, personal injury, or damage to equipment since the protection provided by the equipment may be impaired.

AVERTISSEMENT

FONCTIONNEMENT INATTENDU DE L'EQUIPEMENT

Ne dépassez aucune évaluation spécifiée dans le tableau de caractéristiques environnementales et électriques..

Le fait de ne pas suivre les instructions peut entraîner une défaillance de la protection fournie par l'équipement, ce qui peut entraîner des conséquences graves, comme des blessures ou des dommages à l'équipement.

4 Wiring

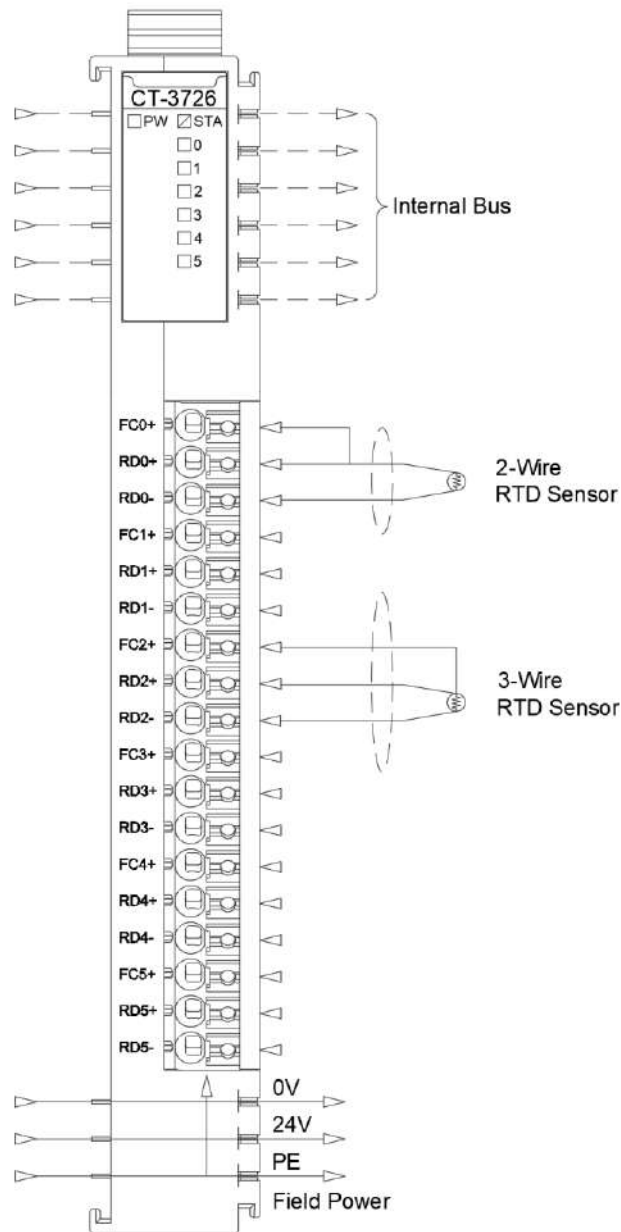

NOTICE

EQUIPMENT INOPERABLE

Do not crimp the spring terminal with more than the maximum pressure specified for the terminal. Otherwise, the resilience of the spring terminal may be damaged and the terminal rebound may be affected.

Do not press the spring terminal with a sharp tool when removing cable from the channel. Otherwise, the spring terminal will be damaged.

Failure to follow these instructions may result in equipment damage.

5 Process data definition

Input data								
Bit No	Bit 7	Bit 6	Bit 5	Bit 4	Bit 3	Bit 2	Bit 1	Bit 0
Byte 0	Analog Input Data(CH 0)							
Byte 1								
Byte 2	Analog Input Data(CH 1)							
Byte 3								
Byte 4	Analog Input Data(CH 2)							
Byte 5								
Byte 6	Analog Input Data(CH 3)							
Byte 7								
Byte 8	Analog Input Data(CH 4)							
Byte 9								
Byte 10	Analog Input Data(CH 5)							
Byte 11								

Data Description:

Analog Input Data (CH0-5): The value of the analog channel input data.

Process data definitions			
temperature	decimal	hexadecimal	location
>880.0	32767	7FFF	Overflow
880.0	8800	2260	Exceeding the upper limit
.	.	.	
.	.	.	
850.1	8501	2135	Rated range
850.0	8500	2134	
.	.	.	
.	.	.	
-200.0	-2000	F830	Lower limit exceeded
-200.1	-2001	F82F	
.	.	.	
.	.	.	
-240.0	-2400	F6A0	Underflow
<-240.0	-32768	8000	

6 Configuration parameter definition

配置参数								
Bit No	Bit 7	Bit 6	Bit 5	Bit 4	Bit 3	Bit 2	Bit 1	Bit 0
Byte 0	Reserved					Temperature Unit		16Bit Data Format
Byte 1	Reserved		Channel Enable (CH 5)	Channel Enable (CH 4)	Channel Enable (CH 3)	Channel Enable (CH 2)	Channel Enable (CH 1)	Channel Enable (CH 0)
Byte 2	CH0 Filter Level							
Byte 3	CH1 Filter Level							
Byte 4	CH2 Filter Level							
Byte 5	CH3 Filter Level							
Byte 6	CH4 Filter Level							
Byte 7	CH5 Filter Level							
Byte 8 - Byte 12	Reserved							

Data Description:

16Bit Data Format: 16-bit data byte transfer order. (Default: 0).

0: A_B

1: B_A

Temperature Unit: The unit of temperature. Degrees Celsius, Fahrenheit, Kelvin are optional. (Default: 0).

0: °C

1: °F

2: K

Channel Enable (CH 0-CH 5): Channel Enable, Disable or Enable is optional. (Default: 1).

0: Disable

1: Enable

CH0-CH5 Filter Level: Filter level, grade 1~7 optional. (Default: 4).

1: Level 1

2: Level 2

3: Level 3

4: Level 4

5: Level 5

6: Level 6

7: Level 7

 **WARNING**

UNEXPECTED EQUIPMENT OPERATION

The filtering parameters could be adjusted according to the field conditions. If the parameter settings are inappropriate, the signal will be lost.

Failure to follow instructions specified by the manufacturer may result in serious consequences such as death, personal injury, or damage to equipment since the protection provided by the equipment may be impaired.

 **AVERTISSEMENT**

FONCTIONNEMENT INATTENDU DE L'EQUIPEMENT

Les paramètres de filtrage peuvent être ajustés en fonction des conditions du site. Si les paramètres ne sont pas réglés correctement, la perte de signal se produira.

Le fait de ne pas suivre les instructions peut entraîner une défaillance de la protection fournie par l'équipement, ce qui peut entraîner des conséquences graves, comme des blessures ou des dommages à l'équipement.

A Dimensional drawing

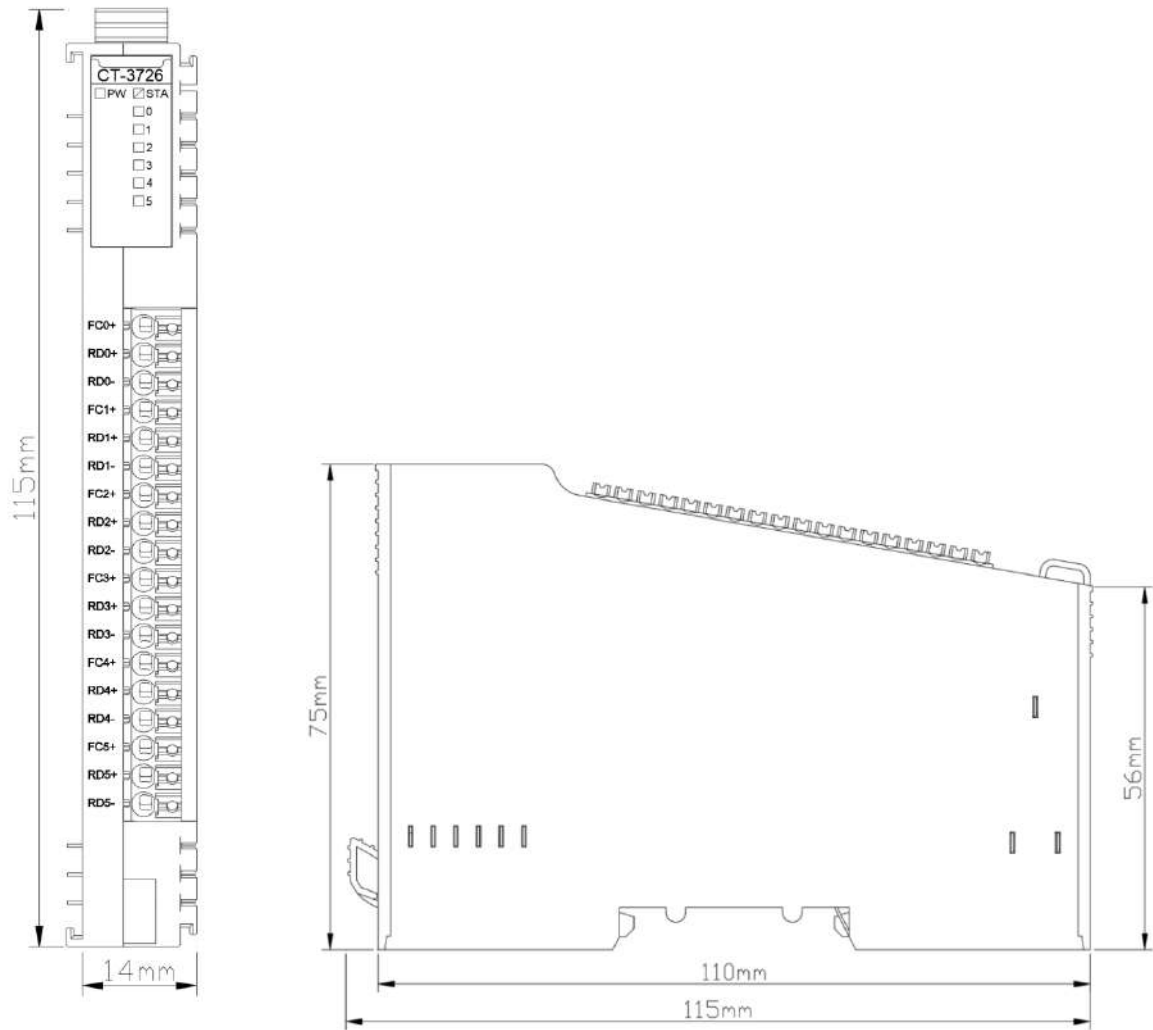

CT-3734 4 channels RTD-PT100 temperature acquisition module

1 Module features

- ◆ The module supports 4-channel RTD thermal resistance (PT100) temperature acquisition
- ◆ The channels are isolated, and the isolation voltage is 1500V
- ◆ The module could be connected to a 2-wire or 3-wire PT100 temperature sensor
- ◆ The internal bus of the module and field input adopts magnetic isolation
- ◆ The module carries with 4 analog input channel LED indicator
- ◆ 15-bits ADC resolution

2 Technical Parameters

General Parameters	
Power	Max.65mA@5.0Vdc
Isolation	I/O to internal bus: magnetic isolation (2.5KVrms)
Field Power	Not used
Wiring	Max.: AWG 18
Mounting Type	35mm Din-rail
Size	115*14*75mm
Weight	65g
Vibration Resistance	Comply with IEC 61131-2 and EC 60068-2-6
Impact resistance	Comply with IEC 61131-2 and IEC 60068-2-27
EMC Performance	Comply with IEC 61131-2 and IEC 61000-4
Environment Specification	
Operating Temperature of Horizontal Installation	-35°C~70°C
Operating Temperature of Vertical Installation	-35°C~60°C
Relative Humidity	< 95%RH (No Condensation)
Storage Temperature	-40°C~85°C
Storage Humidity	< 95%RH (No Condensation)
Manufacturing Test Temperature	-40°C~75°C
Ingress Protection Rating	IP20
Input Parameter	
Channel Number	4 channels
LED Indicator	4 Green LED
Resolution	15 Bits
Sensor Type	PT100
Measurement Range	-240~870°C
Measurement Accuracy	0.5°C
Conversion Rate	100ms/4 channels
Diagnostic Function	32766: The sensor is not connected or disconnected -32766: Short Circuited 32765: Chip failure 32767: Overflow -32768: Underflow

WARNING

UNEXPECTED EQUIPMENT OPERATION

Do not exceed any of the ratings specified in the environmental and electrical characteristics

table.

Failure to follow instructions specified by the manufacturer may result in serious consequences such as death, personal injury, or damage to equipment since the protection provided by the equipment may be impaired.

 AVERTISSEMENT

FONCTIONNEMENT INATTENDU DE L'EQUIPEMENT

Ne dépassez aucune évaluation spécifiée dans le tableau de caractéristiques environnementales et électriques..

Le fait de ne pas suivre les instructions peut entraîner une défaillance de la protection fournie par l'équipement, ce qui peut entraîner des conséquences graves, comme des blessures ou des dommages à l'équipement.

3 Hardware Interface

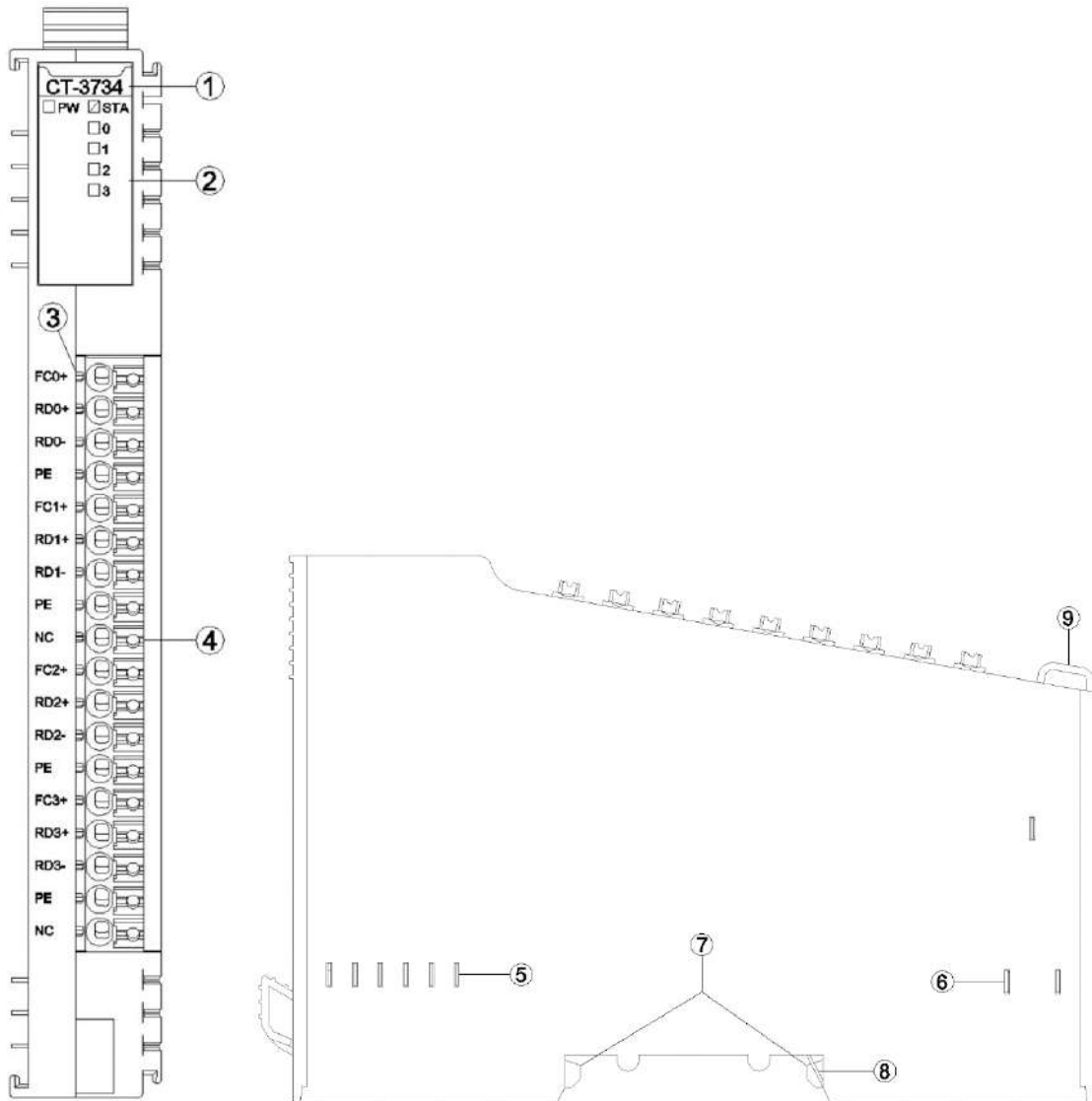

- ① Module Type
- ② State indicator
- ③ N/A
- ④ Wiring Terminal and identification
- ⑤ Internal Bus
- ⑥ Field Power
- ⑦ Buckle
- ⑧ Grounding Spring Sheet
- ⑨ Fixed Wiring Harness

3.1 LED indicator definition

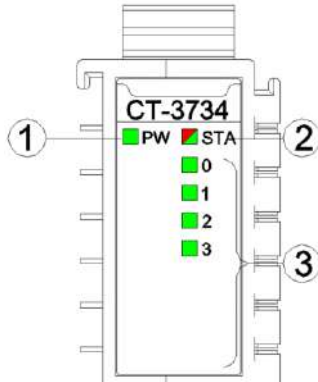

- ① Power LED indicator (green)
- ② Module State LED indicator (red/green)
- ③ Input channel LED indicator (green)

PW POWER STATE (GREEN)	Definition
ON	Internal bus Power Normal
OFF	Internal bus Power Failure
STA MODULE STATE (RED/GREEN)	Definition
Green slow flash (2.5Hz)	Module internal bus is not started
Red slow flash (2.5Hz)	Module internal bus offline
ON (GREEN)	Operation normal
Flash(2.5Hz) (RED/GREEN)	Upgrading mode
Flash(10Hz) (RED/GREEN)	Firmware Update
Double Flash (RED)	Module Exception, has been soft-restarted
0-3 Channel Indicator	Definition
ON	The input signal exceeds 1% of the range
OFF	Invalid input signal

⚠ WARNING

UNEXPECTED EQUIPMENT OPERATION

By viewing the PW indicator, could determine the power supply status of a module. If the PW is steady green, the power supply is normal. Otherwise, the module cannot work properly.

When the module is initially powered on, there will be 3S for the backplane bus connection. After the backplane bus is initialized, STA is in the green steady state. If STA is in the green blinking state, it indicates that the backplane bus has not been initialized, and it needs to be powered off and restarted for re-initialization.

STA abnormal working state occurs during the normal operation of the module, please check the

firmware version information of all modules, and consult ODOT technical support for details.
If a module is upgraded, check that all modules are in the normal state after the upgrade. Otherwise, an exception may occur.

Failure to follow instructions specified by the manufacturer may result in serious consequences such as death, personal injury, or damage to equipment since the protection provided by the equipment may be impaired.

AVERTISSEMENT

FONCTIONNEMENT INATTENDU DE L'EQUIPEMENT

En regardant l'état de l'indicateur de PW, jugez l'état d'alimentation du module. Le feu vert PW reste allumé et l'alimentation est normale. Autrement, le module ne fonctionnera pas correctement.

Lorsque le module est alimenté initialement, il y aura 3S pour la connexion de bus de backboard. STA est un état vert permanent après l'initialisation du bus de backboard. Si STA est en état de clignotement vert, cela signifie que l'initialisation du bus de backboard n'est pas passée et doit être redémarrée hors tension et réinitialisée.

L'état de fonctionnement anormal de STA se produit pendant le fonctionnement normal du module, veuillez vérifier les informations de version du firmware de tous les modules, et consulter le support technique ODOT pour plus de détails.

Si le module a une opération de mise à niveau, après l'achèvement de la mise à niveau, le besoin de vérifier que tous les modules sont dans l'état normal avant de courir, sinon il conduira à une exception.

Le fait de ne pas suivre les instructions peut entraîner une défaillance de la protection fournie par l'équipement, ce qui peut entraîner des conséquences graves, comme des blessures ou des dommages à l'équipement.

3.2 Terminal definition

Terminal Number	Definition	Description
1	FC0+	Signal Input CH0
2	RD0+	
3	RD0-	
4	PE	
5	FC1+	Signal Input CH1
6	RD1+	
7	RD1-	
8	PE	
9	NC	N/A
10	FC2+	Signal Input CH2

11	RD2+	
12	RD2-	
13	PE	
14	FC3+	Signal Input CH3
15	RD3+	
16	RD3-	
17	PE	
18	NC	N/A

WARNING

UNEXPECTED EQUIPMENT OPERATION

Calculate the maximum field power current consumption of a single module based on the actual field load. If the total field power current consumption of all I/O modules exceeds the power supply capacity of the field power supply, you must add an extra power expansion module. Otherwise, an output channel exception may occur.

Failure to follow instructions specified by the manufacturer may result in serious consequences such as death, personal injury, or damage to equipment since the protection provided by the equipment may be impaired.

AVERTISSEMENT

FONCTIONNEMENT INATTENDU DE L'EQUIPEMENT

Calculez la consommation maximale de courant de champ d'un seul module en fonction de la charge de champ réelle. Si la consommation totale de courant de champ de tous les modules d'E/S dépasse la capacité d'alimentation de l'alimentation de champ, vous devez ajouter un module d'extension de puissance supplémentaire. Dans le cas contraire, une exception de canal de sortie peut se produire.

Le fait de ne pas suivre les instructions peut entraîner une défaillance de la protection fournie par l'équipement, ce qui peut entraîner des conséquences graves, comme des blessures ou des dommages à l'équipement.

When connecting a cold-pressed terminal, the terminal must be terminated and checked in strict accordance with the corresponding termination specifications or requirements, and connect the cold-pressed terminal according to the corresponding node serial number. The conductor should use copper conductor and the conductor core should be larger than 0.2mm² and smaller than 1mm². Cold-pressed terminal parameters are as follows:



⚠️ WARNING

UNEXPECTED EQUIPMENT OPERATION

Strip the length of the conductor insulation layer is greater than 10mm to ensure reliable signal connection.

The wire needs to use copper wire and the wire core is greater than or equal to 0.2mm² and less than or equal to 1mm² to ensure reliable signal connection.

When connecting a cold-press terminal, connect the cold-press terminal strictly in accordance with the corresponding termination specifications or requirements, and connect the cold-press terminal according to the corresponding node serial number.

Do not power on cold-press terminals until they are properly connected or fully locked.

Failure to follow instructions specified by the manufacturer may result in serious consequences such as death, personal injury, or damage to equipment since the protection provided by the equipment may be impaired.

⚠️ AVERTISSEMENT

FONCTIONNEMENT INATTENDU DE L'EQUIPEMENT

Dépouillez la longueur de la couche isolante du fil plus de 10mm pour assurer la connexion fiable du signal.

Le conducteur doit utiliser le fil de cuivre et le noyau de fil est supérieur ou égal à 0,2 mm², inférieur ou égal à 1mm², afin d'assurer la connexion fiable du signal.

Lorsque les terminaux de presse à froid sont terminés, ils doivent être terminés et visualisés en stricte conformité avec les spécifications ou les exigences correspondantes et terminés selon le numéro de série de noeud correspondant.

Il est interdit d'activer les bornes à froid avant qu'elles ne soient correctement articulées ou complètement verrouillées.

Le fait de ne pas suivre les instructions peut entraîner une défaillance de la protection fournie par l'équipement, ce qui peut entraîner des conséquences graves, comme des blessures ou des dommages à l'équipement.

DANGER

FIRE DANGER

Use the correct wiring rules only for the maximum current capacity of the I/O channel and power supply.

Failure to follow instructions specified by the manufacturer may result in serious consequences such as death, personal injury, or damage to equipment since the protection provided by the equipment may be impaired.

WARNING

UNEXPECTED EQUIPMENT OPERATION

Do not exceed any of the ratings specified in the environmental and electrical characteristics table.

Failure to follow instructions specified by the manufacturer may result in serious consequences such as death, personal injury, or damage to equipment since the protection provided by the equipment may be impaired.

AVERTISSEMENT

FONCTIONNEMENT INATTENDU DE L'EQUIPEMENT

Ne dépassez aucune évaluation spécifiée dans le tableau de caractéristiques environnementales et électriques..

Le fait de ne pas suivre les instructions peut entraîner une défaillance de la protection fournie par l'équipement, ce qui peut entraîner des conséquences graves, comme des blessures ou des dommages à l'équipement.

4 Wiring

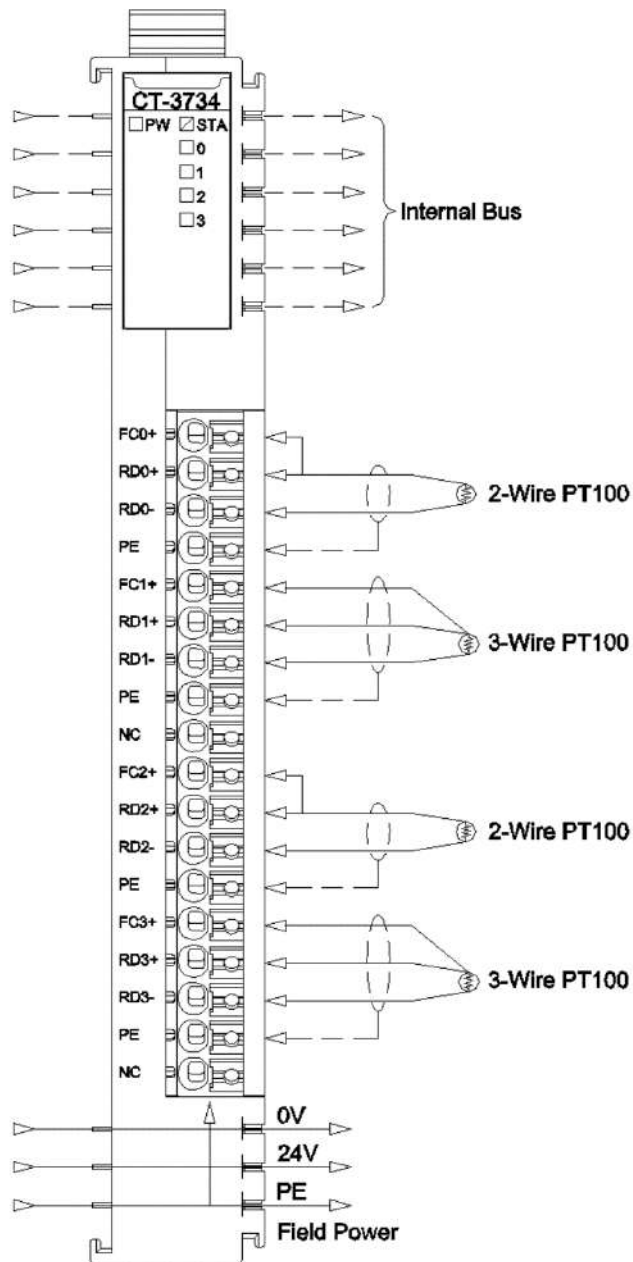

NOTICE

EQUIPMENT INOPERABLE

Do not crimp the spring terminal with more than the maximum pressure specified for the terminal. Otherwise, the resilience of the spring terminal may be damaged and the terminal rebound may be affected.

Do not press the spring terminal with a sharp tool when removing cable from the channel. Otherwise, the spring terminal will be damaged.

Failure to follow these instructions may result in equipment damage.

5 Process data definition

Input data								
Bit No	Bit 7	Bit 6	Bit 5	Bit 4	Bit 3	Bit 2	Bit 1	Bit 0
Byte 0	Analog Input Data (CH 0)							
Byte 1								
Byte 2	Analog Input Data (CH 1)							
Byte 3								
Byte 4	Analog Input Data (CH 2)							
Byte 5								
Byte 6	Analog Input Data (CH 3)							
Byte 7								

Data description:

Analog Input Data (CH0-2): Analog channel input data values

Process data definition			
Temperature	Decimal	Hexadecimal	Location
>880.0	32767	7FFF	Overflow
>880.0	32766	7FFE	Channel break
>880.0	32765	7FFD	ADC chip fault
>880.0	32764	7FFC	Overvoltage and undervoltage faults
>880.0	32763	7FFB	ADC conversion exception
880.0	8800	2260	Exceeding the upper limit
.	.	.	
.	.	.	
850.1	8501	2135	
850.0	8500	2134	Rated range
.	.	.	
.	.	.	
-200.0	-2000	F830	
-200.1	-2001	F82F	Lower limit exceeded
.	.	.	
.	.	.	
-240.0	-2400	F6A0	
<-240.0	-32767	7FFF	Channel disable
<-240.0	-32768	8000	underflow

6 Configuration parameters definition

配置参数								
Bit No	Bit 7	Bit 6	Bit 5	Bit 4	Bit 3	Bit 2	Bit 1	Bit 0
Byte 0	Reserved					Temperature Unit		16Bit Data Format
Byte 1	Filter_Level(CH 1)			Filter_Level (CH 0)				
Byte 1	Filter_Level(CH 3)			Filter_Level (CH 2)				
Byte 2	Reserved							

Data description:

16Bit Data Format: Sequence of 16-bit data byte transmission (Default: 0)

0: A_B

1: B_A

Temperature Unit: A unit of temperature. Degrees Celsius, Fahrenheit, Kelvin are optional. (Default :0)

0: °C

1: °F

2: K

Filtering Level Ch (0-3): Filtering Level. (Default: 6)

1: Level 1

2: Level 2

3: Level 3

4: Level 4

5: Level 5

6: Level 6

7: Level 7

8: Level 8

9: Level 9

 **WARNING**

UNEXPECTED EQUIPMENT OPERATION

The filtering parameters could be adjusted according to the field conditions. If the parameter settings are inappropriate, the signal will be lost.

Failure to follow instructions specified by the manufacturer may result in serious consequences such as death, personal injury, or damage to equipment since the protection provided by the equipment may be impaired.

 **AVERTISSEMENT**

FONCTIONNEMENT INATTENDU DE L'EQUIPEMENT

Les paramètres de filtrage peuvent être ajustés en fonction des conditions du site. Si les paramètres ne sont pas réglés correctement, la perte de signal se produira.

Le fait de ne pas suivre les instructions peut entraîner une défaillance de la protection fournie par l'équipement, ce qui peut entraîner des conséquences graves, comme des blessures ou des dommages à l'équipement.

A Dimension drawing

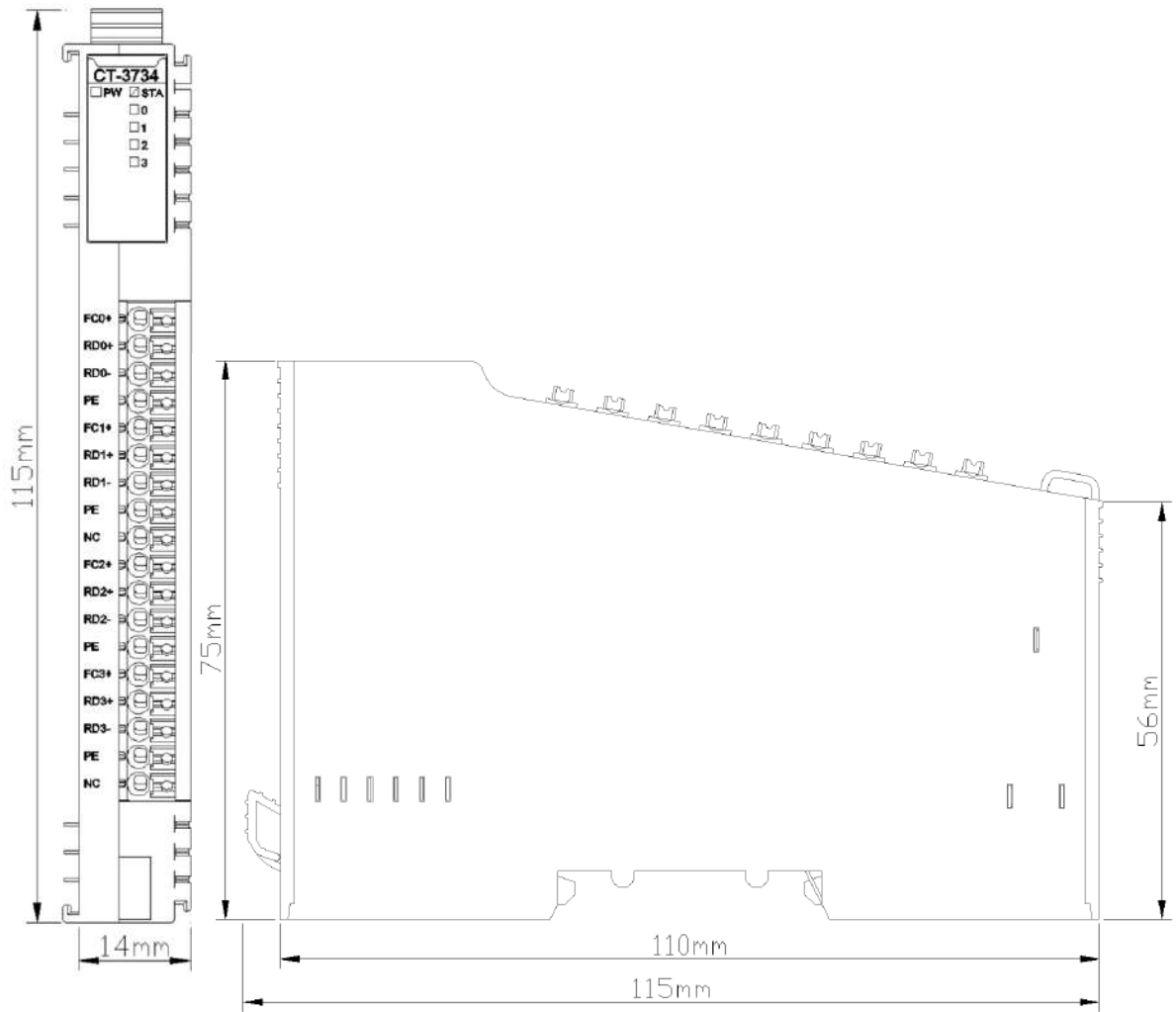

CT-3744 4-channel RTD-PT1000 Temperature Acquisition Module

1 Module Features

- ◆ The module supports 4-channel RTD thermal resistance (PT1000) temperature acquisition
- ◆ There is isolation between channels, and the isolation voltage is 500V
- ◆ The module could be connected to 2-wire or 3-wire PT1000 temperature sensor
- ◆ The module has 4 analog input channel LED indicators
- ◆ 15 bit ADC resolution

2 Technical Parameters

General Parameter	
Power	Max.115mA@5.0VDC
Isolation	The isolation voltage between I/O channel and system power is AC500V The isolation voltage between I/O channel and field power is AC500V The isolation voltage between I/O channel and PE is AC500V Channel isolation AC500V
Field power	Not used
Wiring	Max.: AWG 18 Min.: AWG 24
Mounting Type	35mm DIN-rail
Size	115*14*75mm
Weight	65g
Environment Specification	
Operating Temperature	-35~70°C
Ambient Humidity	5%~95% No condensation
Ingress Protection Rating	IP20
Input parameter	
Channel Number	4-channel input
Indicator	4 RTD channel input indicator
Resolution	15 Bits
Sensor type	PT1000 RTD
Measurement Range	-240~880°C
Measurement Accuracy	0.5°C
Conversion Rate	100ms/4 channel
Diagnostic Function	32766: The sensor is not connected or disconnected -32766: Short Circuited 32765: Chip failure 32767: Overflow -32768: Underflow
EMC Parameter	
Static	Contact 4KV/Air 8KV
EFT	2KV

⚠ WARNING

UNEXPECTED EQUIPMENT OPERATION

Do not exceed any of the ratings specified in the environmental and electrical characteristics table.

Failure to follow instructions specified by the manufacturer may result in serious consequences such as death, personal injury, or damage to equipment since the protection provided by the equipment may be impaired.

 **AVERTISSEMENT**

FONCTIONNEMENT INATTENDU DE L'EQUIPEMENT

Ne dépassez aucune évaluation spécifiée dans le tableau de caractéristiques environnementales et électriques..

Le fait de ne pas suivre les instructions peut entraîner une défaillance de la protection fournie par l'équipement, ce qui peut entraîner des conséquences graves, comme des blessures ou des dommages à l'équipement.

3 Hardware Interface

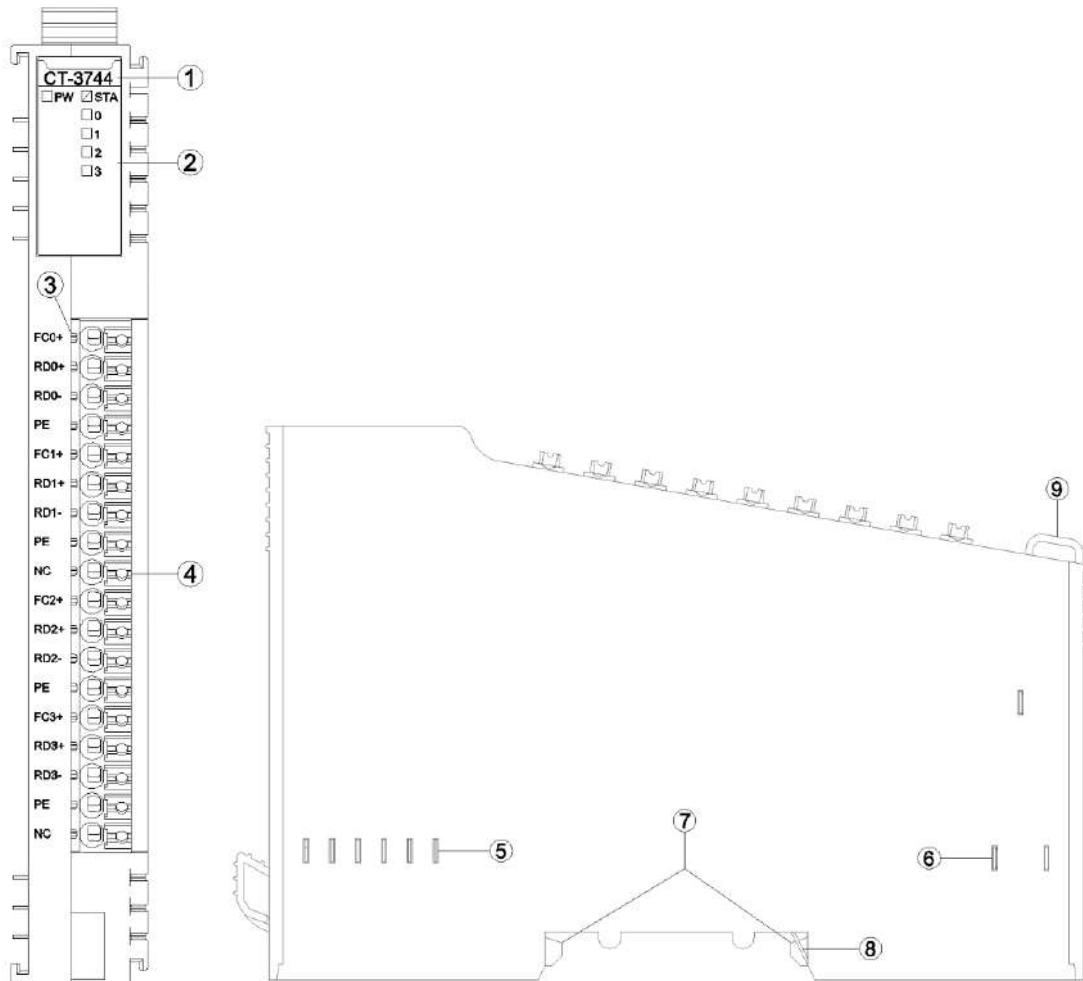

- ① Module Type
- ② State indicator
- ③ N/A
- ④ Wiring Terminal and identification
- ⑤ Internal Bus
- ⑥ Field Power
- ⑦ Buckle
- ⑧ Grounding Spring Sheet
- ⑨ Fixed Wiring Harness

3.1 LED indicator definition

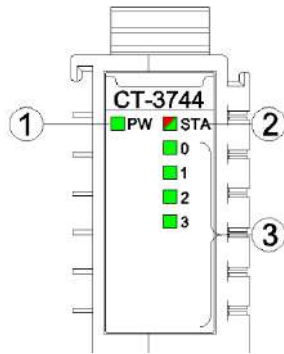

- ① Power LED indicator (green)
- ② Module State LED indicator (red/green)
- ③ Input channel LED indicator (green)

PW POWER STATE (GREEN)	Definition
ON	Internal bus Power Normal
OFF	Internal bus Power Failure
STA MODULE STATE (RED/GREEN)	Definition
Green slow flash (2.5Hz)	Module internal bus is not started
Red slow flash (2.5Hz)	Module internal bus offline
ON (GREEN)	Operation normal
Flash(2.5Hz) (RED/GREEN)	Upgrading mode
Flash(10Hz) (RED/GREEN)	Firmware Update
Double Flash (RED)	Module Exception, has been soft-restarted
0-3 Channel Indicator	Definition
ON	The input signal exceeds 1% of the range
OFF	Invalid input signal

⚠ WARNING

UNEXPECTED EQUIPMENT OPERATION

By viewing the PW indicator, could determine the power supply status of a module. If the PW is steady green, the power supply is normal. Otherwise, the module cannot work properly.

When the module is initially powered on, there will be 3S for the backplane bus connection. After the backplane bus is initialized, STA is in the green steady state. If STA is in the green blinking state, it indicates that the backplane bus has not been initialized, and it needs to be powered off and restarted for re-initialization.

STA abnormal working state occurs during the normal operation of the module, please check the

firmware version information of all modules, and consult ODOT technical support for details.
If a module is upgraded, check that all modules are in the normal state after the upgrade. Otherwise, an exception may occur.

Failure to follow instructions specified by the manufacturer may result in serious consequences such as death, personal injury, or damage to equipment since the protection provided by the equipment may be impaired.

AVERTISSEMENT

FONCTIONNEMENT INATTENDU DE L'EQUIPEMENT

En regardant l'état de l'indicateur de PW, jugez l'état d'alimentation du module. Le feu vert PW reste allumé et l'alimentation est normale. Autrement, le module ne fonctionnera pas correctement.

Lorsque le module est alimenté initialement, il y aura 3S pour la connexion de bus de backboard. STA est un état vert permanent après l'initialisation du bus de backboard. Si STA est en état de clignotement vert, cela signifie que l'initialisation du bus de backboard n'est pas passée et doit être redémarrée hors tension et réinitialisée.

L'état de fonctionnement anormal de STA se produit pendant le fonctionnement normal du module, veuillez vérifier les informations de version du firmware de tous les modules, et consulter le support technique ODOT pour plus de détails.

Si le module a une opération de mise à niveau, après l'achèvement de la mise à niveau, le besoin de vérifier que tous les modules sont dans l'état normal avant de courir, sinon il conduira à une exception.

Le fait de ne pas suivre les instructions peut entraîner une défaillance de la protection fournie par l'équipement, ce qui peut entraîner des conséquences graves, comme des blessures ou des dommages à l'équipement.

3.2 Terminal definition

端子序号	定义	说明
1	FC0+	Signal Input CH0
2	RD0+	
3	RD0-	
4	PE	
5	FC1+	Signal Input CH1
6	RD1+	
7	RD1-	
8	PE	
9	NC	N/A
10	FC2+	Signal Input CH2
11	RD2+	

12	RD2-	
13	PE	
14	FC3+	Signal Input CH3
15	RD3+	
16	RD3-	
17	PE	
18	NC	
		N/A

WARNING

UNEXPECTED EQUIPMENT OPERATION

Calculate the maximum field power current consumption of a single module based on the actual field load. If the total field power current consumption of all I/O modules exceeds the power supply capacity of the field power supply, you must add an extra power expansion module. Otherwise, an output channel exception may occur.

Failure to follow instructions specified by the manufacturer may result in serious consequences such as death, personal injury, or damage to equipment since the protection provided by the equipment may be impaired.

AVERTISSEMENT

FONCTIONNEMENT INATTENDU DE L'EQUIPEMENT

Calculez la consommation maximale de courant de champ d'un seul module en fonction de la charge de champ réelle. Si la consommation totale de courant de champ de tous les modules d'E/S dépasse la capacité d'alimentation de l'alimentation de champ, vous devez ajouter un module d'extension de puissance supplémentaire. Dans le cas contraire, une exception de canal de sortie peut se produire.

Le fait de ne pas suivre les instructions peut entraîner une défaillance de la protection fournie par l'équipement, ce qui peut entraîner des conséquences graves, comme des blessures ou des dommages à l'équipement.

When connecting a cold-pressed terminal, the terminal must be terminated and checked in strict accordance with the corresponding termination specifications or requirements, and connect the cold-pressed terminal according to the corresponding node serial number. The conductor should use copper conductor and the conductor core should be larger than 0.2mm² and smaller than 1mm² (AWG18~AWG24). Cold-pressed terminal parameters are as follows:

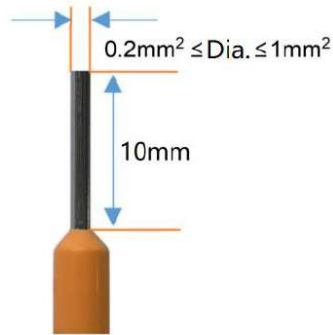

! WARNING

UNEXPECTED EQUIPMENT OPERATION

Strip the length of the conductor insulation layer is greater than 10mm to ensure reliable signal connection.

The wire needs to use copper wire and the wire core is greater than or equal to 0.2mm^2 and less than or equal to 1mm^2 to ensure reliable signal connection.

When connecting a cold-press terminal, connect the cold-press terminal strictly in accordance with the corresponding termination specifications or requirements, and connect the cold-press terminal according to the corresponding node serial number.

Do not power on cold-press terminals until they are properly connected or fully locked.

Failure to follow instructions specified by the manufacturer may result in serious consequences such as death, personal injury, or damage to equipment since the protection provided by the equipment may be impaired.

! AVERTISSEMENT

FONCTIONNEMENT INATTENDU DE L'EQUIPEMENT

Dépouillez la longueur de la couche isolante du fil plus de 10mm pour assurer la connexion fiable du signal.

Le conducteur doit utiliser le fil de cuivre et le noyau de fil est supérieur ou égal à $0,2\text{ mm}^2$, inférieur ou égal à 1mm^2 , afin d'assurer la connexion fiable du signal.

Lorsque les terminaux de presse à froid sont terminés, ils doivent être terminés et visualisés en stricte conformité avec les spécifications ou les exigences correspondantes et terminés selon le numéro de série de noeud correspondant.

Il est interdit d'activer les bornes à froid avant qu'elles ne soient correctement articulées ou complètement verrouillées.

Le fait de ne pas suivre les instructions peut entraîner une défaillance de la protection fournie par l'équipement, ce qui peut entraîner des conséquences graves, comme des blessures ou des dommages à l'équipement.

DANGER

FIRE DANGER

Use the correct wiring rules only for the maximum current capacity of the I/O channel and power supply.

Failure to follow instructions specified by the manufacturer may result in serious consequences such as death, personal injury, or damage to equipment since the protection provided by the equipment may be impaired.

WARNING

UNEXPECTED EQUIPMENT OPERATION

Do not exceed any of the ratings specified in the environmental and electrical characteristics table.

Failure to follow instructions specified by the manufacturer may result in serious consequences such as death, personal injury, or damage to equipment since the protection provided by the equipment may be impaired.

AVERTISSEMENT

FONCTIONNEMENT INATTENDU DE L'EQUIPEMENT

Ne dépassez aucune évaluation spécifiée dans le tableau de caractéristiques environnementales et électriques..

Le fait de ne pas suivre les instructions peut entraîner une défaillance de la protection fournie par l'équipement, ce qui peut entraîner des conséquences graves, comme des blessures ou des dommages à l'équipement.

4 Wiring

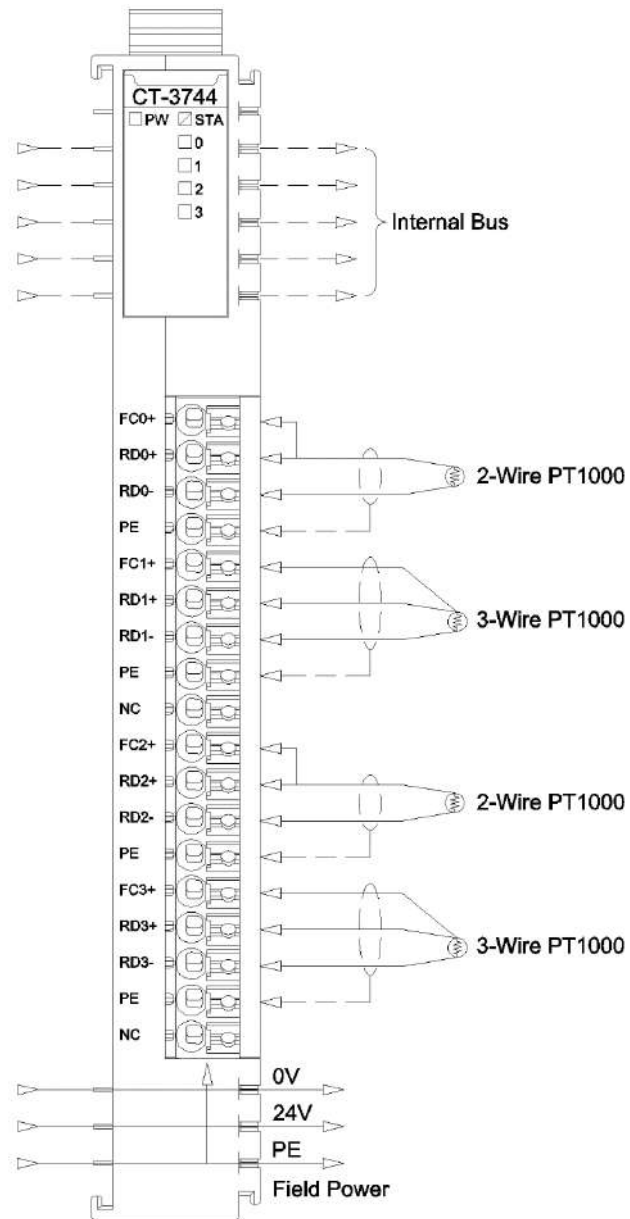

NOTICE

EQUIPMENT INOPERABLE

Do not crimp the spring terminal with more than the maximum pressure specified for the terminal. Otherwise, the resilience of the spring terminal may be damaged and the terminal rebound may be affected.

Do not press the spring terminal with a sharp tool when removing cable from the channel. Otherwise, the spring terminal will be damaged.

Failure to follow these instructions may result in equipment damage.

5 Process data definition

Input data								
Bit No	Bit 7	Bit 6	Bit 5	Bit 4	Bit 3	Bit 2	Bit 1	Bit 0
Byte 0	Analog Input Data(CH 0)							
Byte 1								
Byte 2	Analog Input Data(CH 1)							
Byte 3								
Byte 4	Analog Input Data(CH 2)							
Byte 5								
Byte 6	Analog Input Data(CH 3)							
Byte 7								

Data description:

Analog Input Data (CH0-2): Analog channel input data value.

Process data definition			
Temperature	Decimal	Hexadecimal	Location
>870.0	32767	7FFF	Overflow
>870.0	32766	7FFE	Channel break
>870.0	32765	7FFD	ADC chip fault
>870.0	32764	7FFC	Overvoltage and undervoltage fault
>870.0	32763	7FFB	ADC Conversation fault
870.0	8800	2260	Exceeding the upper limit
.	.	.	
.	.	.	
850.1	8501	2135	Rated range
850.0	8500	2134	
.	.	.	
-200.0	-2000	F830	
-200.1	-2001	F82F	Lower limit exceeded
.	.	.	
.	.	.	
-240.0	-2400	F6A0	
<-240.0	-32767	7FFF	Channel disable
<-240.0	-32768	8000	Underflow

6 Configuration parameters definition

Configuration parameter									
Bit No	Bit 7	Bit 6	Bit 5	Bit 4	Bit 3	Bit 2	Bit 1	Bit 0	
Byte 0	Reserved					Temperature Unit		16Bit Data Format	
Byte 1	Filter_Level(CH 1)			Filter_Level (CH 0)					
Byte 1	Filter_Level(CH 3)			Filter_Level (CH 2)					
Byte 2	Reserved								

Data description:

16Bit Data Format: 16-bit data byte transfer sequence. (Default: 0)

0: A_B

1: B_A

Temperature Unit: A unit of temperature. Degrees Celsius, Fahrenheit, Kelvin are optional. (Default :0)

0: °C

1: °F

2: K

Filtering Level Ch (0-3): Filtering Level. (Default: 6)

1: Level 1

2: Level 2

3: Level 3

4: Level 4

5: Level 5

6: Level 6

7: Level 7

8: Level 8

9: Level 9

WARNING

UNEXPECTED EQUIPMENT OPERATION

The filtering parameters could be adjusted according to the field conditions. If the parameter settings are inappropriate, the signal will be lost.

Failure to follow instructions specified by the manufacturer may result in serious consequences such as death, personal injury, or damage to equipment since the protection provided by the equipment may be impaired.

 AVERTISSEMENT

FONCTIONNEMENT INATTENDU DE L'EQUIPEMENT

Les paramètres de filtrage peuvent être ajustés en fonction des conditions du site. Si les paramètres ne sont pas réglés correctement, la perte de signal se produira.

Le fait de ne pas suivre les instructions peut entraîner une défaillance de la protection fournie par l'équipement, ce qui peut entraîner des conséquences graves, comme des blessures ou des dommages à l'équipement.

A Dimension drawing

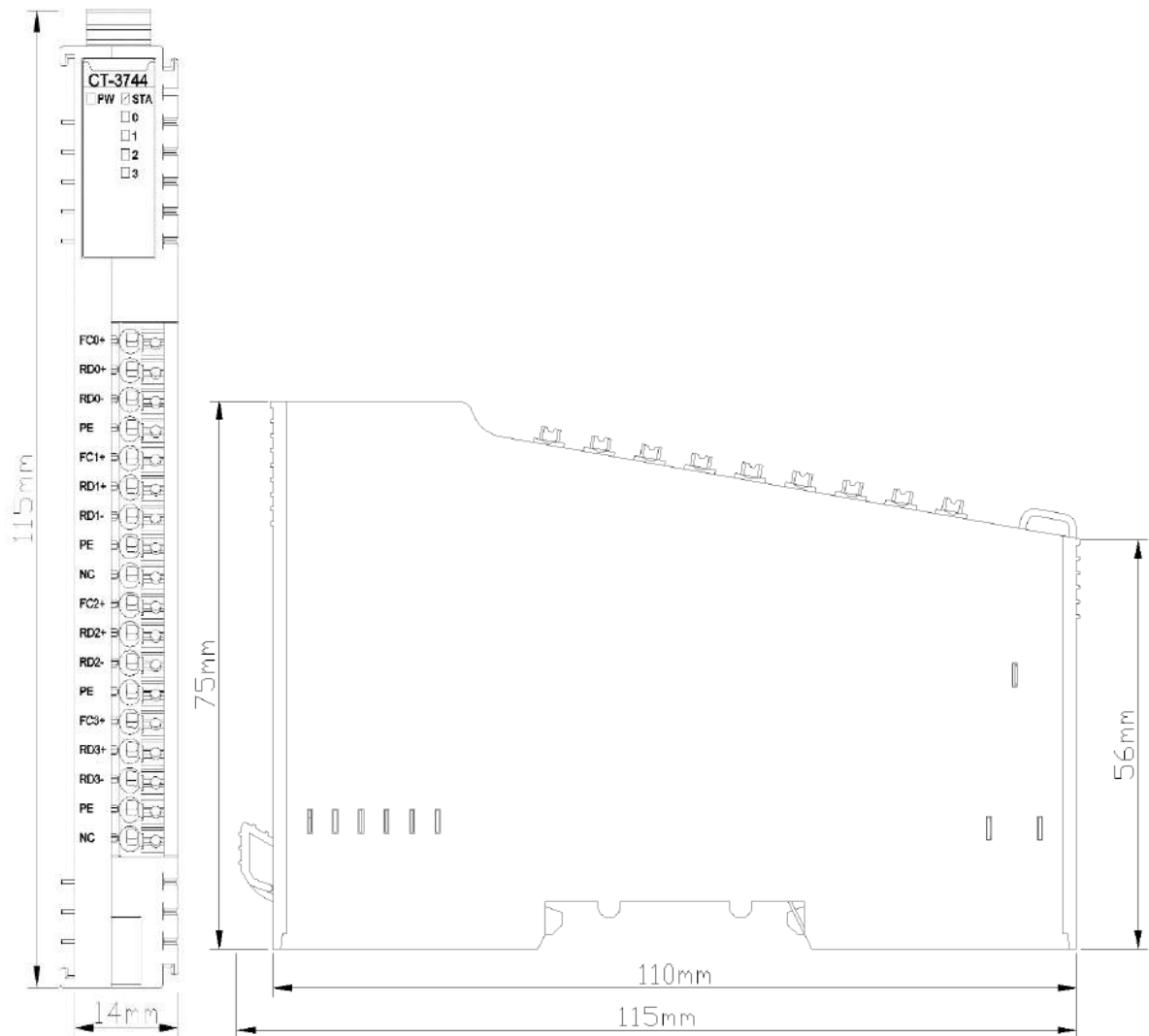

CT-3804 4-channel TC thermocouple temperature acquisition module

1 Module features

- ◆ The module supports 4-channel thermocouple signal acquisition
- ◆ The module carries with 4 analog LED indicators
- ◆ The module supports 8 kinds of conventional thermocouple temperature measurement type
- ◆ The internal bus of the module and field input adopts magnetic isolation
- ◆ The module input channel supports TVS overvoltage protection
- ◆ 24-bit ADC resolution (Σ - δ type)

2 Technical Parameters

General Parameters		
Power	Max.50mA@5.0Vdc	
Isolation	I/O to internal bus: magnetic isolation (2.5KVrms)	
Field Power	Not used	
Wiring	Max.: AWG 18	
Mounting Type	35mmDIN-Rail	
Size	115*14*75mm	
Weight	65g	
Environment Specification		
Operating Temperature of Horizontal Installation	-35°C~70°C	
Operating Temperature of Vertical Installation	-35°C~60°C	
Relative Humidity	< 95%RH (No Condensation)	
Storage Temperature	-40°C~85°C	
Storage Humidity	< 95%RH (No Condensation)	
Manufacturing Test Temperature	-40°C~75°C	
Ingress Protection Rating	IP20	
Input Parameter		
Channel Number	4 Channels	
LED Indicator	4 Input LED Indicators	
Sensor Type	J / K / E / T / S / R / B / N type thermocouples	
Acquisition Accuracy	±0.3% Full Scale, @25°C ±0.5% Full Scale, @-40~85°C	
Sampling Rate	70ms/4 channels	
Measuring Range °C	J Type	-210~1200°C
	K Type	-270~1370°C
	E Type	-270~1000°C
	T Type	-270~400°C
	S Type	-50~1760°C
	R Type	-50~1760°C
	B Type	0~1820°C
	N Type	-270~1300°C
C Type	0~2320°C (not available)	
Data Format	16-Bit Signed Integer (Integer)	
Diagnostic Function	-32767: No thermocouple model selected (that is, the channel is disabled) 32766: open circuit disconnection 32767: Temperature overflow -32768: Temperature underflow 32765: ADC chip fault 32764: cold junction compensation conversation fault value	

 **WARNING**

UNEXPECTED EQUIPMENT OPERATION

Do not exceed any of the ratings specified in the environmental and electrical characteristics table.

Failure to follow instructions specified by the manufacturer may result in serious consequences such as death, personal injury, or damage to equipment since the protection provided by the equipment may be impaired.

 **AVERTISSEMENT**

FONCTIONNEMENT INATTENDU DE L'EQUIPEMENT

Ne dépassez aucune évaluation spécifiée dans le tableau de caractéristiques environnementales et électriques..

Le fait de ne pas suivre les instructions peut entraîner une défaillance de la protection fournie par l'équipement, ce qui peut entraîner des conséquences graves, comme des blessures ou des dommages à l'équipement.

3 Hardware Interface

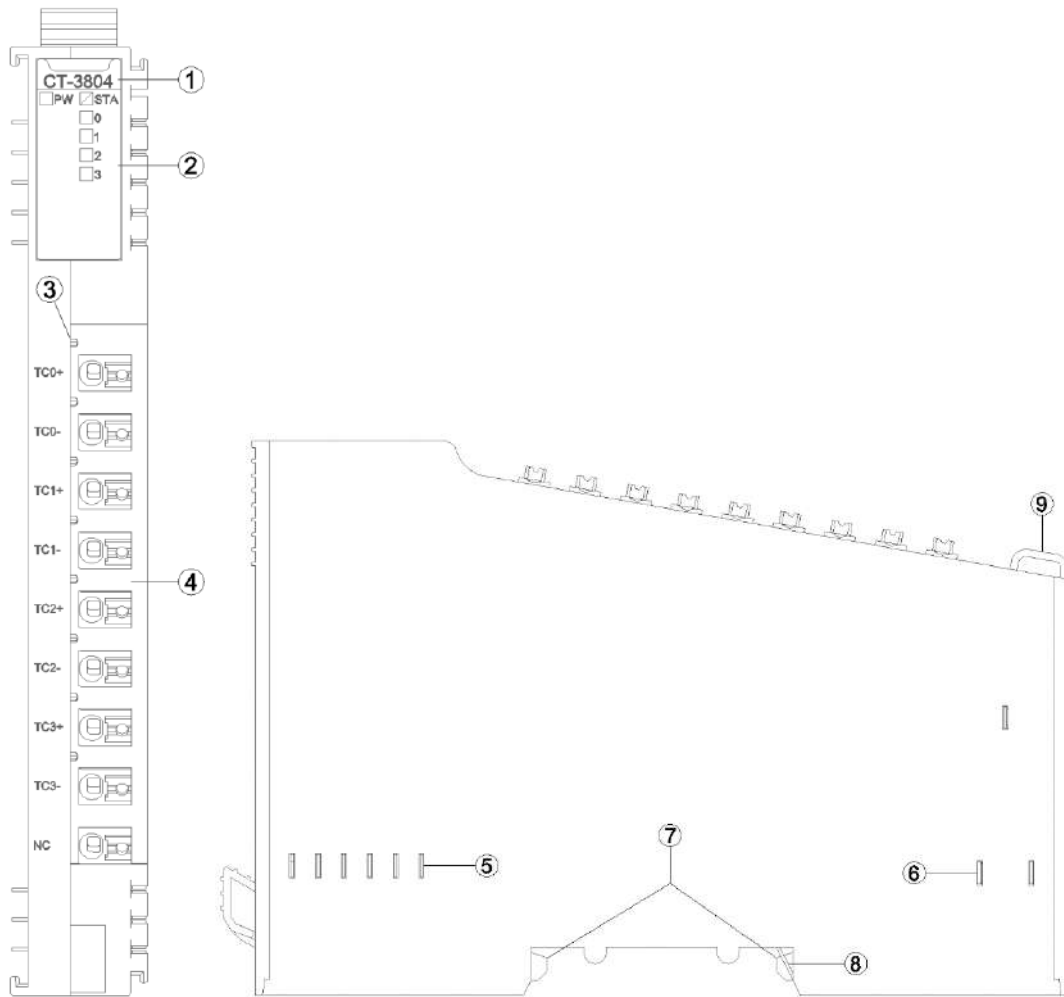

- ① Module Type
- ② State indicator
- ③ N/A
- ④ Wiring Terminal and identification
- ⑤ Internal Bus
- ⑥ Field Power
- ⑦ Buckle
- ⑧ Grounding Spring Sheet
- ⑨ Fixed Wiring Harness

3.1 LED indicator definition

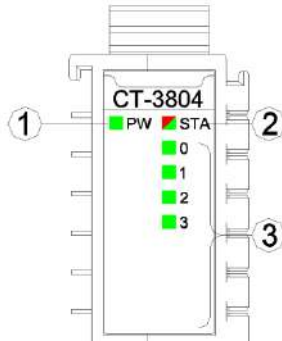

- ① Power LED indicator (green)
- ② Module State LED indicator (red/green)
- ③ Input channel LED indicator (green)

PW POWER STATE (GREEN)	Definition
ON	Internal bus Power Normal
OFF	Internal bus Power Failure
STA MODULE STATE (RED/GREEN)	Definition
Green slow flash (2.5Hz)	Module internal bus is not started
Red slow flash (2.5Hz)	Module internal bus offline
ON (GREEN)	Operation normal
Flash(2.5Hz) (RED/GREEN)	Upgrading mode
Flash(10Hz) (RED/GREEN)	Firmware Update
Double Flash (RED)	Module Exception has been soft-restarted
0-3 Channel Indicator	Definition
ON	The input signal exceeds 1% of the range
OFF	Invalid input signal

WARNING

UNEXPECTED EQUIPMENT OPERATION

By viewing the PW indicator, could determine the power supply status of a module. If the PW is steady green, the power supply is normal. Otherwise, the module cannot work properly.

When the module is initially powered on, there will be 3S for the backplane bus connection. After the backplane bus is initialized, STA is in the green steady state. If STA is in the green blinking state, it indicates that the backplane bus has not been initialized, and it needs to be powered off and restarted for re-initialization.

STA abnormal working state occurs during the normal operation of the module, please check the firmware version information of all modules, and consult ODOT technical support for details.

If a module is upgraded, check that all modules are in the normal state after the upgrade. Otherwise, an exception may occur.

Failure to follow instructions specified by the manufacturer may result in serious consequences such as death, personal injury, or damage to equipment since the protection provided by the equipment may be impaired.

AVERTISSEMENT

FONCTIONNEMENT INATTENDU DE L'EQUIPEMENT

En regardant l'état de l'indicateur de PW, jugez l'état d'alimentation du module. Le feu vert PW reste allumé et l'alimentation est normale. Autrement, le module ne fonctionnera pas correctement.

Lorsque le module est alimenté initialement, il y aura 3S pour la connexion de bus de backboard. STA est un état vert permanent après l'initialisation du bus de backboard. Si STA est en état de clignotement vert, cela signifie que l'initialisation du bus de backboard n'est pas passée et doit être redémarrée hors tension et réinitialisée.

L'état de fonctionnement anormal de STA se produit pendant le fonctionnement normal du module, veuillez vérifier les informations de version du firmware de tous les modules, et consulter le support technique ODOT pour plus de détails.

Si le module a une opération de mise à niveau, après l'achèvement de la mise à niveau, le besoin de vérifier que tous les modules sont dans l'état normal avant de courir, sinon il conduira à une exception.

Le fait de ne pas suivre les instructions peut entraîner une défaillance de la protection fournie par l'équipement, ce qui peut entraîner des conséquences graves, comme des blessures ou des dommages à l'équipement.

3.2 Terminal definition

Terminal Number	Definition	Description
1	TC0+	Signal Input CH0
2	TC0-	
3	TC1+	Signal Input CH1
4	TC1-	
5	TC2+	Signal Input CH2
6	TC2-	
7	TC3+	Signal Input CH3
8	TC3-	
9	NC	Not Connected

⚠️ WARNING

UNEXPECTED EQUIPMENT OPERATION

Calculate the maximum field power current consumption of a single module based on the actual field load. If the total field power current consumption of all I/O modules exceeds the power supply capacity of the field power supply, you must add an extra power expansion module. Otherwise, an output channel exception may occur.

Failure to follow instructions specified by the manufacturer may result in serious consequences such as death, personal injury, or damage to equipment since the protection provided by the equipment may be impaired.

⚠️ AVERTISSEMENT

FONCTIONNEMENT INATTENDU DE L'ÉQUIPEMENT

Calculez la consommation maximale de courant de champ d'un seul module en fonction de la charge de champ réelle. Si la consommation totale de courant de champ de tous les modules d'E/S dépasse la capacité d'alimentation de l'alimentation de champ, vous devez ajouter un module d'extension de puissance supplémentaire. Dans le cas contraire, une exception de canal de sortie peut se produire.

Le fait de ne pas suivre les instructions peut entraîner une défaillance de la protection fournie par l'équipement, ce qui peut entraîner des conséquences graves, comme des blessures ou des dommages à l'équipement.

When connecting a cold-pressed terminal, the terminal must be terminated and checked in strict accordance with the corresponding termination specifications or requirements, and connect the cold-pressed terminal according to the corresponding node serial number. The conductor should use copper conductor and the conductor core should be larger than 0.2mm^2 and smaller than 1mm^2 (AWG18~AWG24). Cold-pressed terminal parameters are as follows:

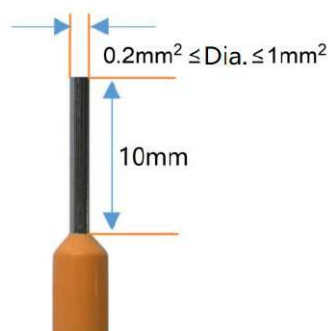

WARNING

UNEXPECTED EQUIPMENT OPERATION

Strip the length of the conductor insulation layer is greater than 10mm to ensure reliable signal connection.

The wire needs to use copper wire and the wire core is greater than or equal to 0.2mm² and less than or equal to 1mm² to ensure reliable signal connection.

When connecting a cold-press terminal, connect the cold-press terminal strictly in accordance with the corresponding termination specifications or requirements, and connect the cold-press terminal according to the corresponding node serial number.

Do not power on cold-press terminals until they are properly connected or fully locked.

Failure to follow instructions specified by the manufacturer may result in serious consequences such as death, personal injury, or damage to equipment since the protection provided by the equipment may be impaired.

AVERTISSEMENT

FONCTIONNEMENT INATTENDU DE L'EQUIPEMENT

Dépouillez la longueur de la couche isolante du fil plus de 10mm pour assurer la connexion fiable du signal.

Le conducteur doit utiliser le fil de cuivre et le noyau de fil est supérieur ou égal à 0,2 mm², inférieur ou égal à 1mm², afin d'assurer la connexion fiable du signal.

Lorsque les terminaux de presse à froid sont terminés, ils doivent être terminés et visualisés en stricte conformité avec les spécifications ou les exigences correspondantes et terminés selon le numéro de série de noeud correspondant.

Il est interdit d'activer les bornes à froid avant qu'elles ne soient correctement articulées ou complètement verrouillées.

Le fait de ne pas suivre les instructions peut entraîner une défaillance de la protection fournie par l'équipement, ce qui peut entraîner des conséquences graves, comme des blessures ou des dommages à l'équipement.

DANGER

FIRE DANGER

Use the correct wiring rules only for the maximum current capacity of the I/O channel and power supply.

Failure to follow instructions specified by the manufacturer may result in serious consequences such as death, personal injury, or damage to equipment since the protection provided by the equipment may be impaired.

 **WARNING**

UNEXPECTED EQUIPMENT OPERATION

Do not exceed any of the ratings specified in the environmental and electrical characteristics table.

Failure to follow instructions specified by the manufacturer may result in serious consequences such as death, personal injury, or damage to equipment since the protection provided by the equipment may be impaired.

 **AVERTISSEMENT**

FONCTIONNEMENT INATTENDU DE L'EQUIPEMENT

Ne dépassez aucune évaluation spécifiée dans le tableau de caractéristiques environnementales et électriques..

Le fait de ne pas suivre les instructions peut entraîner une défaillance de la protection fournie par l'équipement, ce qui peut entraîner des conséquences graves, comme des blessures ou des dommages à l'équipement.

4 Wiring

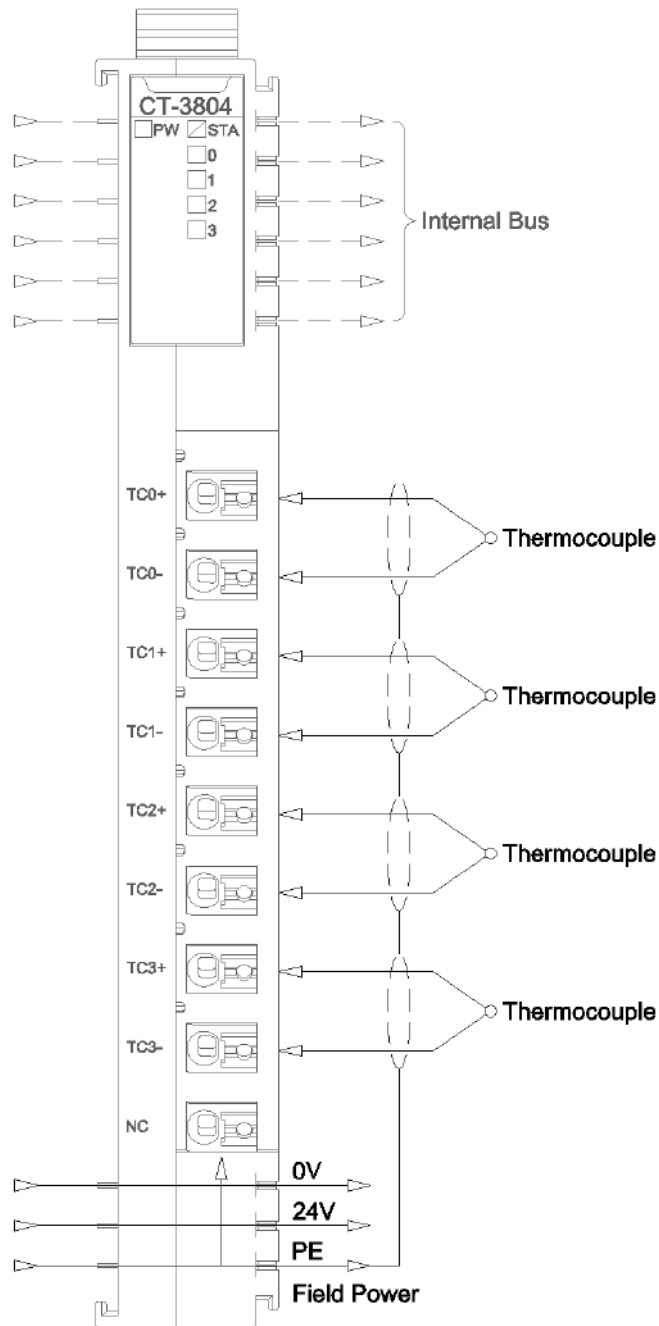

! WARNING

UNEXPECTED EQUIPMENT OPERATION

Do not link wires to unused terminals and/or terminals marked "NO CONNECTION (NC)".

Failure to follow instructions specified by the manufacturer may result in serious consequences such as death, personal injury, or damage to equipment since the protection provided by the equipment may be impaired.

AVERTISSEMENT

FONCTIONNEMENT INATTENDU DE L'EQUIPEMENT

Ne liez pas les fils aux bornes inutilisées et/ou aux bornes marquées «NO CONNECTION (NC)».

Le fait de ne pas suivre les instructions peut entraîner une défaillance de la protection fournie par l'équipement, ce qui peut entraîner des conséquences graves, comme des blessures ou des dommages à l'équipement.

NOTICE

EQUIPMENT INOPERABLE

Do not crimp the spring terminal with more than the maximum pressure specified for the terminal. Otherwise, the resilience of the spring terminal may be damaged and the terminal rebound may be affected.

Do not press the spring terminal with a sharp tool when removing cable from the channel. Otherwise, the spring terminal will be damaged.

Failure to follow these instructions may result in equipment damage.

5 Process data definition

Input Data								
Bit No	Bit 7	Bit 6	Bit 5	Bit 4	Bit 3	Bit 2	Bit 1	Bit 0
Byte 0	Analog Input Data(CH 0)							
Byte 1								
Byte 2	Analog Input Data(CH 1)							
Byte 3								
Byte 4	Analog Input Data(CH 2)							
Byte 5								
Byte 6	Analog Input Data(CH 3)							
Byte 7								

Data description:

Analog Input Data (CH0-3): The current temperature acquisition value of the corresponding channel

Process Data Definition - J Type			
Temperature	Decimal	Hex	Location
>1360.0	32767	7FFF	Overflow
>1360.0	32766	7FFE	Break line
>1360.0	32765	7FFD	ADC chip failure
>1360.0	32764	7FFC	Module cold junction compensation sensor chip fault
>1360.0	32763	7FFB	Module cold junction compensation sensor
1360.0	13600	3520	Exceeds the upper limit
.	.	.	
.	.	.	
1200.1	12001	2EE1	Rated range
1200.0	12000	2EE0	
.	.	.	
.	.	.	
-210.0	-2100	F7CC	Underflow
<-210.0	-32768	8000	

Process Data Definition - K Type			
Temperature	Decimal	Hex	Location
>1622.0	32767	7FFF	Overflow

1622.0	16220	3F5C	Exceeds the upper limit
.	.	.	
.	.	.	
1372.1	13721	3599	Rated range
1372.0	13720	3598	
.	.	.	
-270.0	-2700	F574	
<-270.0	-32768	8000	Underflow
Process Data Definition – E Type			
Temperature	Decimal	Hex	Location
>1200.0	32767	7FFF	Overflow
1200.0	12000	2EE0	Exceeds the upper limit
.	.	.	
.	.	.	
1000.1	10001	2711	Rated range
1000.0	10000	2710	
.	.	.	
.	.	.	
-270.0	-2700	F574	Underflow
<-270.0	-32768	8000	

Process Data Definition –T Type			
Temperature	Decimal	Hex	Location
>540.0	32767	7FFF	Overflow
540.0	5400	1518	Exceeds the upper limit
.	.	.	
.	.	.	
400.1	4001	FA1	Rated range
400.0	4000	FA0	
.	.	.	
.	.	.	
-270.0	-2700	F574	Underflow
<-270.0	-32768	8000	

Process Data Definition –S Type			
Temperature	Decimal	Hex	Location
>1850.0	32767	7FFF	Overflow
1850.0	18500	4844	Exceeds the upper limit
.	.	.	
.	.	.	
1769.1	17691	451B	
1769.0	17690	451A	Rated range
.	.	.	
.	.	.	
-50.0	-500	FE0C	
-50.1	-501	FE0B	Exceeds the lower limit
.	.	.	
.	.	.	
-170.0	-1700	F95C	
<-170.0	-32768	8000	Underflow

Process Data Definition – R Type			
Temperature	Decimal	Hex	Location
>2019.0	32767	7FFF	Overflow
2019.0	20190	4EDE	Exceeds the upper limit
.	.	.	
.	.	.	
1769.1	17691	451B	
1769.0	17690	451A	Rated range
.	.	.	
.	.	.	
-50.0	-500	FE0C	
-50.1	-501	FE0B	Exceeds the lower limit
.	.	.	
.	.	.	
-170.0	-1700	F95C	
<-170.0	-32768	8000	Underflow

Process Data Definition - B Type			
Temperature	Decimal	Hex	Location
>2070.0	32767	7FFF	Overflow
2070.0	20700	50DC	Exceeds the upper limit
.	.	.	
.	.	.	
1820.1	18201	4719	
1820.0	18200	4718	Rated range
.	.	.	
.	.	.	
0.0	0		
<0.0	-32768	8000	Underflow

Process Data Definition – N Type			
Temperature	Decimal	Hex	Location
>1550.0	32767	7FFF	Overflow
1550.0	15500	3C8C	Exceeds the upper limit
.	.	.	
.	.	.	
1300.1	13001	32C9	
1300.0	13000	32C8	Rated range
.	.	.	
.	.	.	
-270.0	-2700	F574	
<-270.0	-32768	8000	Underflow

Process Data Definition – C Type			
Temperature	Decimal	Hex	Location
>2320.0	32767	7FFF	Overflow
2320.0	23200	5AA0	Rated range
.	.	.	
.	.	.	
0.0	0		
<0.0	-32768	8000	Underflow

6 Configuration parameters definition

配置参数								
Bit No	Bit 7	Bit 6	Bit 5	Bit 4	Bit 3	Bit 2	Bit 1	Bit 0
Byte 0	Reserved					Temperature Unit		16Bit Data Format
Byte 1	TC Input Type (CH 1)				TC Input Type (CH 0)			
Byte 2	TC Input Type (CH 3)				TC Input Type (CH 2)			

Data description:

16Bit Data Format: Big-endian and little-endian format of data upload:

0: A_B

1: B_A

Temperature Unit: temperature unit: (Default:0)

0: degree centigrade °C

1: Fahrenheit °F

2: Kelvin K

TC Input Type(CH 0-3): Sensor type of the channel:

0: Channel is disabled

1: J Type

2: K Type

3: E Type

4: T Type

5: S Type

6: R Type

7: B Type

8: N Type

9: C Type

WARNING

UNEXPECTED EQUIPMENT OPERATION

The filtering parameters could be adjusted according to the field conditions. If the parameter settings are inappropriate, the signal will be lost.

Failure to follow instructions specified by the manufacturer may result in serious consequences such as death, personal injury, or damage to equipment since the protection provided by the equipment may be impaired.

 AVERTISSEMENT

FONCTIONNEMENT INATTENDU DE L'EQUIPEMENT

Les paramètres de filtrage peuvent être ajustés en fonction des conditions du site. Si les paramètres ne sont pas réglés correctement, la perte de signal se produira.

Le fait de ne pas suivre les instructions peut entraîner une défaillance de la protection fournie par l'équipement, ce qui peut entraîner des conséquences graves, comme des blessures ou des dommages à l'équipement.

V2.0 version

Configuration parameter								
Bit No	Bit 7	Bit 6	Bit 5	Bit 4	Bit 3	Bit 2	Bit 1	Bit 0
Byte 0	Reserved					Temperature Unit		16Bit Data Format
Byte 1	TC Input Type (CH 1)				TC Input Type (CH 0)			
Byte 2	TC Input Type (CH 3)				TC Input Type (CH 2)			
Byte 3	Filter_Level_CH1				Filter_Level_CH0			
Byte 4	Filter_Level_CH3				Filter_Level_CH2			
Byte 5	Reserved							

Data description:

16Bit Data Format: Size end format of data upload:

0: A_B

1: B_A

Temperature Unit: temperature unit: (默认: 0)

0: degree centigrade °C

1: Fahrenheit °F

2: Kelvin K

TC Input Type(CH 0-3): The type of thermocouple input for this channel:

0: N/A

1: J Type

2: K Type

3: E Type

4: T Type

5: S Type

6: R Type

7: B Type

8: N Type

Filtering Level Ch (0-3): Filtering level. (default: 1)

0: Level 0

1: Level 1

- 2: Level 2
- 3: Level 3
- 4: Level 4
- 5: Level 5
- 6: Level 6
- 7: Level 7
- 8: Level 8
- 9: Level 9
- 10: Level 10
- 11: Level 11
- 12: Level 12

 **WARNING**

UNEXPECTED EQUIPMENT OPERATION

The filtering parameters could be adjusted according to the field conditions. If the parameter settings are inappropriate, the signal will be lost.

Failure to follow instructions specified by the manufacturer may result in serious consequences such as death, personal injury, or damage to equipment since the protection provided by the equipment may be impaired.

 **AVERTISSEMENT**

FONCTIONNEMENT INATTENDU DE L'EQUIPEMENT

Les paramètres de filtrage peuvent être ajustés en fonction des conditions du site. Si les paramètres ne sont pas réglés correctement, la perte de signal se produira.

Le fait de ne pas suivre les instructions peut entraîner une défaillance de la protection fournie par l'équipement, ce qui peut entraîner des conséquences graves, comme des blessures ou des dommages à l'équipement.

A Dimension drawing

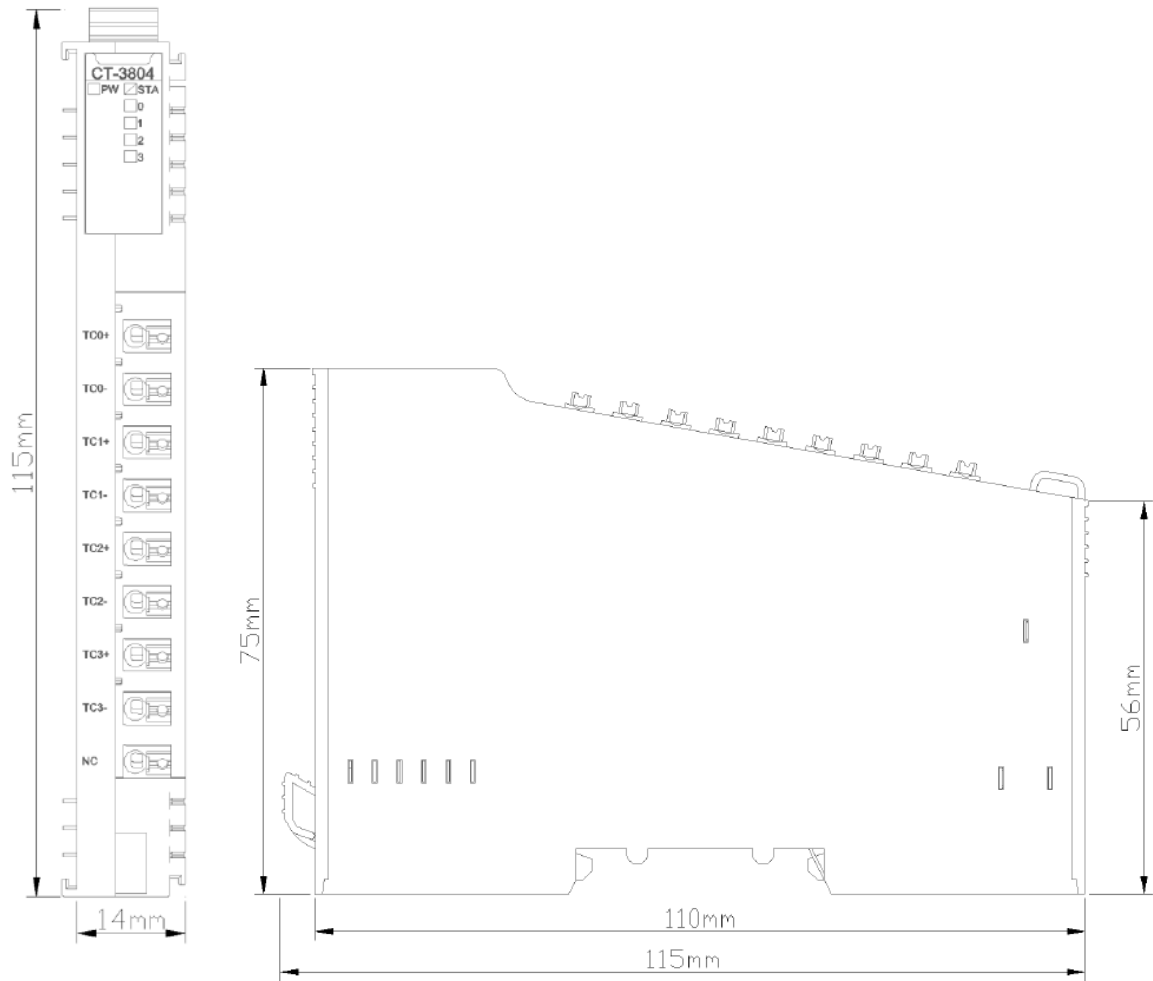

CT-3808 8 channels Analog Input, Thermocouple (TC-J, K, E, T, S, R, B, N) types

1 Module features

- ◆ The module supports 8-channel thermocouple signal acquisition
- ◆ The module carries 8 analog LED indicators
- ◆ The module supports 9 kinds of conventional thermocouple temperature measurement type
- ◆ The internal bus of the module and field input adopts magnetic isolation
- ◆ The module input channel supports TVS overvoltage protection
- ◆ 24-bit ADC resolution (Σ - δ type)
- ◆ Fixed Value Parameter

2 Technical parameters

General Parameters		
Power	Max.60mA@5.0Vdc	
Isolation	I/O to internal bus: magnetic isolation (2.5KVrms)	
Field Power	Not used	
Wiring	Max: AWG 18	
Mounting Type	35mmDIN-Rail	
Size	115*14*75mm	
Weight	65g	
Environment Specification		
Operating Temperature of Horizontal Installation	-35°C~70°C	
Operating Temperature of Vertical Installation	-35°C~60°C	
Relative Humidity	< 95%RH (No Condensation)	
Storage Temperature	-40°C~85°C	
Storage Humidity	< 95%RH (No Condensation)	
Manufacturing Test Temperature	-40°C~75°C	
Ingress Protection Rating	IP20	
Input Parameter		
Channel Number	8 Channels	
LED Indicator	8 Input LED Indicators	
Sensor Type	J / K / E / T / S / R / B / N thermocouples	
Acquisition Accuracy	±0.3% Full Scale, @25°C ±0.5% Full Scale, @-35~60°C	
Sampling Rate	70ms/4 channel	
Measuring Range°C	J Type	-210~1200°C
	K Type	-270~1370°C
	E Type	-270~1000°C
	T Type	-270~400°C
	S Type	-50~1760°C
	R Type	-50~1760°C
	B Type	100~1820°C
	N Type	-270~1300°C
C Type	-270~1300°C (not available)	
Data Format	16-Bit Signed Integer (Integer)	
Diagnostic Function	-32767: No thermocouple model selected (that is, the channel is disabled) 32766: open circuit disconnection 32767: Temperature overflow -32768: Temperature underflow	

 **WARNING**

UNEXPECTED EQUIPMENT OPERATION

Do not exceed any of the ratings specified in the environmental and electrical characteristics table.

Failure to follow instructions specified by the manufacturer may result in serious consequences such as death, personal injury, or damage to equipment since the protection provided by the equipment may be impaired.

 **AVERTISSEMENT**

FONCTIONNEMENT INATTENDU DE L'EQUIPEMENT

Ne dépassez aucune évaluation spécifiée dans le tableau de caractéristiques environnementales et électriques..

Le fait de ne pas suivre les instructions peut entraîner une défaillance de la protection fournie par l'équipement, ce qui peut entraîner des conséquences graves, comme des blessures ou des dommages à l'équipement.

3 Hardware Interface

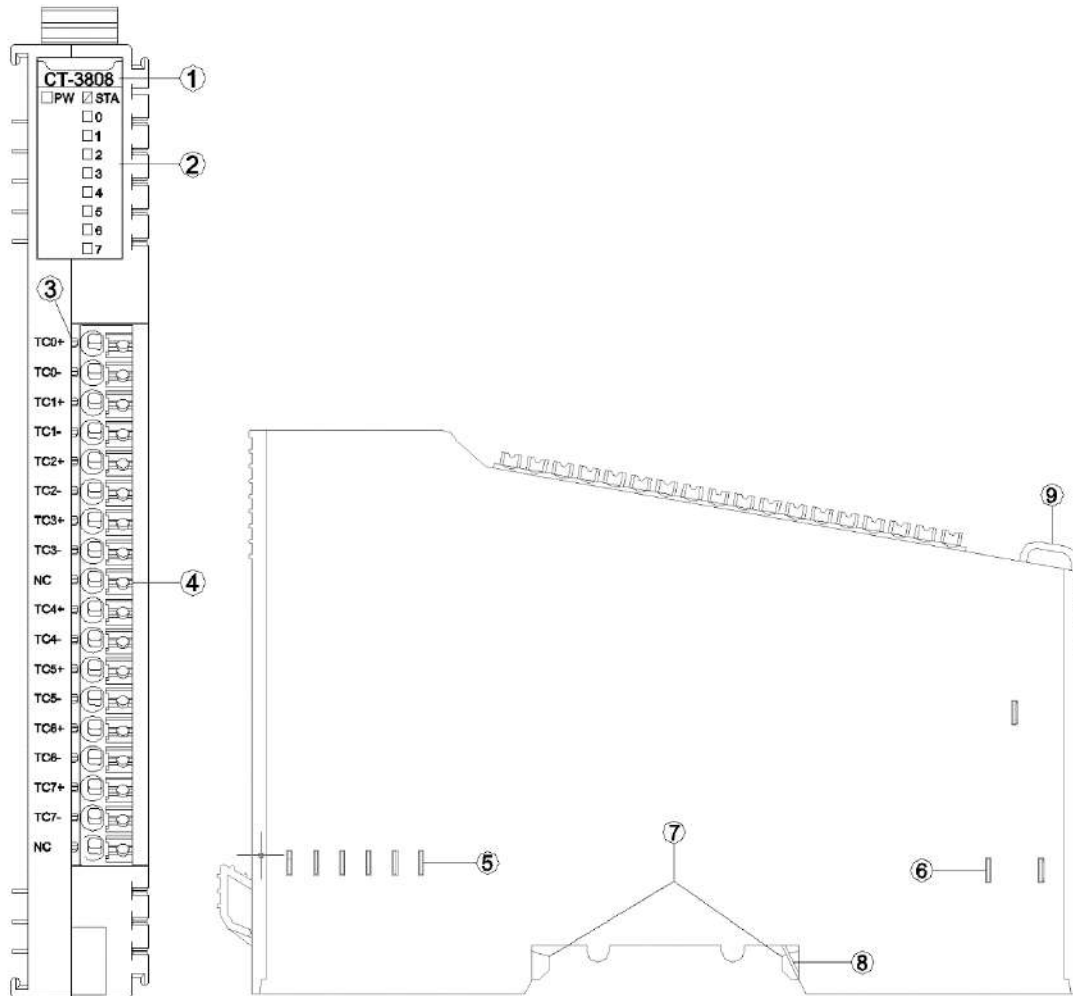

- ① Module Type
- ② State indicator
- ③ N/A
- ④ Wiring Terminal and identification
- ⑤ Internal Bus
- ⑥ Field Power
- ⑦⑦ Buckle
- ⑧ Grounding Spring Sheet
- ⑨ Fixed Wiring Harness

3.1 LED indicator definition

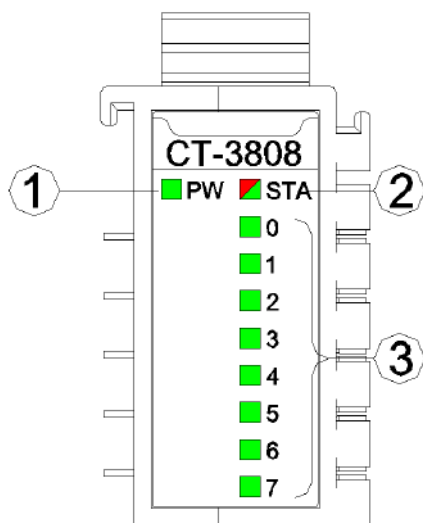

- ① Power LED indicator (green)
- ② Module State LED indicator (red/green)
- ③ Input channel LED indicator (green)

PW POWER STATE (GREEN)	Definition
ON	Internal bus Power Normal
OFF	Internal bus Power Failure
STA MODULE STATE (RED/GREEN)	Definition
Green slow flash (2.5Hz)	Module internal bus is not started
Red slow flash (2.5Hz)	Module internal bus offline
ON (GREEN)	Operation normal
Flash(2.5Hz) (RED/GREEN)	Upgrading mode
Flash(10Hz) (RED/GREEN)	Firmware Update
Double Flash (RED)	Module Exception has been soft-restarted
0-7 Channel Indicator	Definition
ON	The input signal exceeds 1% of the range
OFF	Invalid input signal

⚠️ WARNING

UNEXPECTED EQUIPMENT OPERATION

By viewing the PW indicator, could determine the power supply status of a module. If the PW is steady green, the power supply is normal. Otherwise, the module cannot work properly.

When the module is initially powered on, there will be 3S for the backplane bus connection. After the backplane bus is initialized, STA is in the green steady state. If STA is in the green blinking state, it indicates that the backplane bus has not been initialized, and it needs to be powered off and restarted for re-initialization.

STA abnormal working state occurs during the normal operation of the module, please check the firmware version information of all modules, and consult ODOT technical support for details.

If a module is upgraded, check that all modules are in the normal state after the upgrade. Otherwise, an exception may occur.

Failure to follow instructions specified by the manufacturer may result in serious consequences such as death, personal injury, or damage to equipment since the protection provided by the equipment may be impaired.

AVERTISSEMENT

FONCTIONNEMENT INATTENDU DE L'EQUIPEMENT

En regardant l'état de l'indicateur de PW, jugez l'état d'alimentation du module. Le feu vert PW reste allumé et l'alimentation est normale. Autrement, le module ne fonctionnera pas correctement.

Lorsque le module est alimenté initialement, il y aura 3S pour la connexion de bus de backboard. STA est un état vert permanent après l'initialisation du bus de backboard. Si STA est en état de clignotement vert, cela signifie que l'initialisation du bus de backboard n'est pas passée et doit être redémarrée hors tension et réinitialisée.

L'état de fonctionnement anormal de STA se produit pendant le fonctionnement normal du module, veuillez vérifier les informations de version du firmware de tous les modules, et consulter le support technique ODOT pour plus de détails.

Si le module a une opération de mise à niveau, après l'achèvement de la mise à niveau, le besoin de vérifier que tous les modules sont dans l'état normal avant de courir, sinon il conduira à une exception.

Le fait de ne pas suivre les instructions peut entraîner une défaillance de la protection fournie par l'équipement, ce qui peut entraîner des conséquences graves, comme des blessures ou des dommages à l'équipement.

3.2 Terminal definition

Terminal Number	Definition	Description
1	TC0+	Signal Input CH0
2	TC0-	
3	TC1+	Signal Input CH1
4	TC1-	
5	TC2+	Signal Input CH2
6	TC2-	
7	TC3+	Signal Input CH3
8	TC3-	
9	NC	Not Connected
10	TC4+	Signal Input CH4
11	TC4-	
12	TC5+	Signal Input CH5
13	TC5-	
14	TC6+	Signal Input CH6
15	TC6-	
16	TC7+	Signal Input CH7
17	TC7-	
18	NC	Not Connected

WARNING

UNEXPECTED EQUIPMENT OPERATION

Calculate the maximum field power current consumption of a single module based on the actual field load. If the total field power current consumption of all I/O modules exceeds the power supply capacity of the field power supply, you must add an extra power expansion module. Otherwise, an output channel exception may occur.

Failure to follow instructions specified by the manufacturer may result in serious consequences such as death, personal injury, or damage to equipment since the protection provided by the equipment may be impaired.

AVERTISSEMENT

FONCTIONNEMENT INATTENDU DE L'EQUIPEMENT

Calculez la consommation maximale de courant de champ d'un seul module en fonction de la charge de champ réelle. Si la consommation totale de courant de champ de tous les modules d'E/S dépasse la capacité d'alimentation de l'alimentation de champ, vous devez ajouter un module d'extension de puissance supplémentaire. Dans le cas contraire, une exception de canal de sortie peut se produire.

Le fait de ne pas suivre les instructions peut entraîner une défaillance de la protection fournie par l'équipement, ce qui peut entraîner des conséquences graves, comme des blessures ou des dommages à l'équipement.

When connecting a cold-pressed terminal, the terminal must be terminated and checked in strict accordance with the corresponding termination specifications or requirements, and connect the cold-pressed terminal according to the corresponding node serial number. The conductor should use copper conductor and the conductor core should be larger than 0.2mm^2 and smaller than 1mm^2 (AWG18~AWG24). Cold-pressed terminal parameters are as follows:

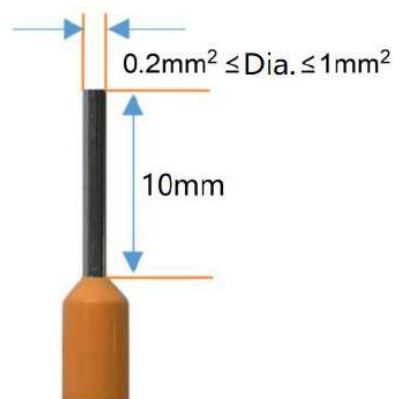

!WARNING

UNEXPECTED EQUIPMENT OPERATION

Strip the length of the conductor insulation layer is greater than 10mm to ensure reliable signal connection.

The wire needs to use copper wire and the wire core is greater than or equal to 0.2mm^2 and less than or equal to 1mm^2 to ensure reliable signal connection.

When connecting a cold-press terminal, connect the cold-press terminal strictly in accordance with the corresponding termination specifications or requirements, and connect the cold-press terminal according to the corresponding node serial number.

Do not power on cold-press terminals until they are properly connected or fully locked.

Failure to follow instructions specified by the manufacturer may result in serious consequences such as death, personal injury, or damage to equipment since the protection provided by the equipment may be impaired.

!AVERTISSEMENT

FONCTIONNEMENT INATTENDU DE L'EQUIPEMENT

Dépouillez la longueur de la couche isolante du fil plus de 10mm pour assurer la connexion fiable du signal.

Le conducteur doit utiliser le fil de cuivre et le noyau de fil est supérieur ou égal à $0,2\text{ mm}^2$,

inférieur ou égal à 1mm², afin d'assurer la connexion fiable du signal.

Lorsque les terminaux de presse à froid sont terminés, ils doivent être terminés et visualisés en stricte conformité avec les spécifications ou les exigences correspondantes et terminés selon le numéro de série de noeud correspondant.

Il est interdit d'activer les bornes à froid avant qu'elles ne soient correctement articulées ou complètement verrouillées.

Le fait de ne pas suivre les instructions peut entraîner une défaillance de la protection fournie par l'équipement, ce qui peut entraîner des conséquences graves, comme des blessures ou des dommages à l'équipement.

DANGER

FIRE DANGER

Use the correct wiring rules only for the maximum current capacity of the I/O channel and power supply.

Failure to follow instructions specified by the manufacturer may result in serious consequences such as death, personal injury, or damage to equipment since the protection provided by the equipment may be impaired.

WARNING

UNEXPECTED EQUIPMENT OPERATION

Do not exceed any of the ratings specified in the environmental and electrical characteristics table.

Failure to follow instructions specified by the manufacturer may result in serious consequences such as death, personal injury, or damage to equipment since the protection provided by the equipment may be impaired.

AVERTISSEMENT

FONCTIONNEMENT INATTENDU DE L'EQUIPEMENT

Ne dépassez aucune évaluation spécifiée dans le tableau de caractéristiques environnementales et électriques..

Le fait de ne pas suivre les instructions peut entraîner une défaillance de la protection fournie par l'équipement, ce qui peut entraîner des conséquences graves, comme des blessures ou des dommages à l'équipement.

4 Wiring

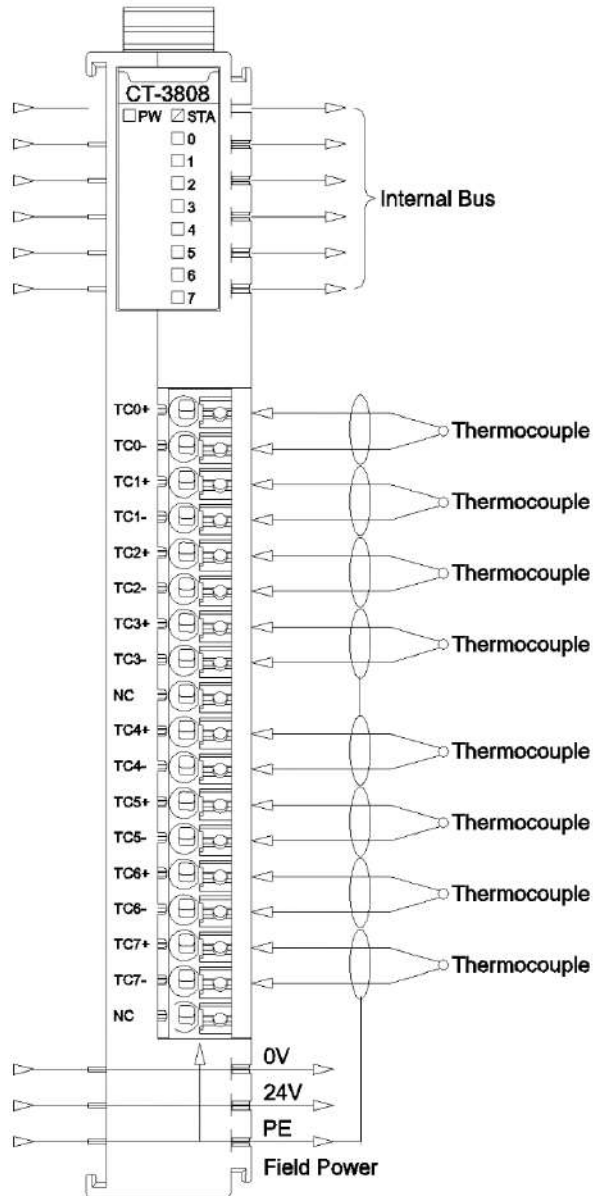

⚠ WARNING

UNEXPECTED EQUIPMENT OPERATION

Do not link wires to unused terminals and/or terminals marked "NO CONNECTION (NC)".

Failure to follow instructions specified by the manufacturer may result in serious consequences such as death, personal injury, or damage to equipment since the protection provided by the equipment may be impaired.

⚠ AVERTISSEMENT

FONCTIONNEMENT INATTENDU DE L'EQUIPEMENT

Ne liez pas les fils aux bornes inutilisées et/ou aux bornes marquées «NO CONNECTION (NC)».

Le fait de ne pas suivre les instructions peut entraîner une défaillance de la protection fournie par l'équipement, ce qui peut entraîner des conséquences graves, comme des blessures ou des dommages à l'équipement.

NOTICE

EQUIPMENT INOPERABLE

Do not crimp the spring terminal with more than the maximum pressure specified for the terminal. Otherwise, the resilience of the spring terminal may be damaged and the terminal rebound may be affected.

Do not press the spring terminal with a sharp tool when removing cable from the channel. Otherwise, the spring terminal will be damaged.

Failure to follow these instructions may result in equipment damage.

5 Process data definition

Input Data								
Bit No	Bit 7	Bit 6	Bit 5	Bit 4	Bit 3	Bit 2	Bit 1	Bit 0
Byte 0	Analog Input Data (CH 0)							
Byte 1								
Byte 2	Analog Input Data (CH 1)							
Byte 3								
Byte 4	Analog Input Data (CH 2)							
Byte 5								
Byte 6	Analog Input Data (CH 3)							
Byte 7								
Byte 8	Analog Input Data (CH 4)							
Byte 9								
Byte 10	Analog Input Data (CH 5)							
Byte 11								
Byte 12	Analog Input Data (CH 6)							
Byte 13								
Byte 14	Analog Input Data (CH 7)							
Byte 15								

Data description:

Analog Input Data (CH0-3) : The current temperature acquisition value of the corresponding channel

Process Data Definition - J Type			
Temperature	Decimal	Hex	Location
>1360.0	32767	7FFF	Overflow
>1360.0	32766	7FFE	Break line
>1360.0	32765	7FFD	ADC chip fault
>1360.0	32764	7FFC	Module cold junction compensation sensor chip fault
>1360.0	32763	7FFB	Module cold junction compensation sensor abnormal work environment
1360.0	13600	3520	Exceeds the upper limit
.	.	.	
.	.	.	

1200.1	12001	2EE1	
1200.0	12000	2EE0	Rated range
.	.	.	
.	.	.	
-210.0	-2100	F7CC	
<-210.0	-32767	7FFF	Channel disabled
<-210.0	-32768	8000	Underflow

Process Data Definition - K Type			
Temperature	Decimal	Hex	Location
>1622.0	32767	7FFF	Overflow
>1622.0	32766	7FFE	Break line
>1622.0	32765	7FFD	ADC chip fault
>1622.0	32764	7FFC	Module cold junction compensation sensor chip fault
>1622.0	32763	7FFB	Module cold junction compensation sensor abnormal work environment
1622.0	16220	3F5C	Exceeds the upper limit
.	.	.	
.	.	.	
1372.1	13721	3599	Rated range
1372.0	13720	3598	
.	.	.	
.	.	.	
-270.0	-2700	F574	Channel disabled
<-270.0	-32767	7FFF	
<-270.0	-32768	8000	

Process Data Definition – E Type			
Temperature	Decimal	Hex	Location
>1200.0	32767	7FFF	Overflow
>1200.0	32766	7FFE	Break line
>1200.0	32765	7FFD	ADC chip fault

>1200.0	32764	7FFC	Module cold junction compensation sensor chip fault
>1200.0	32763	7FFB	Module cold junction compensation sensor abnormal work environment
1200.0	12000	2EE0	Exceeds the upper limit
.	.	.	
.	.	.	
1000.1	10001	2711	
1000.0	10000	2710	Rated range
.	.	.	
.	.	.	
-270.0	-2700	F574	
<-270.0	-32767	7FFF	Channel disabled
<-270.0	-32768	8000	Underflow

Process Data Definition -T Type			
Temperature	Decimal	Hex	Location
>540.0	32767	7FFF	Overflow
>540.0	32766	7FFE	Break line
>540.0	32765	7FFD	ADC chip fault
>540.0	32764	7FFC	Module cold junction compensation sensor chip fault
>540.0	32763	7FFB	Module cold junction compensation sensor abnormal work environment
540.0	5400	1518	Exceeds the upper limit
.	.	.	
.	.	.	
400.1	4001	FA1	
400.0	4000	FA0	Rated range

.	.	.	
.	.	.	
-270.0	-2700	F574	
<-270.0	-32767	7FFF	Channel disabled
<-270.0	-32768	8000	Underflow

Process Data Definition –S Type			
Temperature	Decimal	Hex	Location
>1800.0	32767	7FFF	Overflow
>1800.0	32766	7FFE	Break line
>1800.0	32765	7FFD	ADC chip fault
>1800.0	32764	7FFC	Module cold junction compensation sensor chip fault
>1800.0	32763	7FFB	Module cold junction compensation sensor abnormal work environment
1850.0	18500	4844	Exceeds the upper limit
.	.	.	
.	.	.	
1769.1	17691	451B	Rated range
1769.0	17690	451A	
.	.	.	
.	.	.	
-50.0	-500	FE0C	
-50.1	-501	FE0B	Exceeds the lower limit
.	.	.	
.	.	.	
-170.0	-1700	F95C	Channel disabled
<-170.0	-32767	7FFF	
<-170.0	-32768	8000	

Process Data Definition – R Type			
Temperature	Decimal	Hex	Location
>1940.0	32767	7FFF	Overflow
>1940.0	32766	7FFE	Break line

>1940.0	32765	7FFD	ADC chip fault
>1940.0	32764	7FFC	Module cold junction compensation sensor chip fault
>1940.0	32763	7FFB	Module cold junction compensation sensor abnormal work environment
2019.0	20190	4EDE	Exceeds the upper limit
.	.	.	
.	.	.	
1769.1	17691	451B	Rated range
1769.0	17690	451A	
.	.	.	
.	.	.	
-50.0	-500	FE0C	Exceeds the lower limit
-50.1	-501	FE0B	
.	.	.	
.	.	.	
-170.0	-1700	F95C	Channel disabled
<-110.0	-32767	7FFF	
<-110.0	-32768	8000	Underflow

Process Data Definition - B Type			
Temperature	Decimal	Hex	Location
>2070.0	32767	7FFF	Overflow
>2070.0	32766	7FFE	Break line
>2070.0	32765	7FFD	ADC chip fault
>2070.0	32764	7FFC	Module cold junction compensation sensor chip fault
>2070.0	32763	7FFB	Module cold junction compensation sensor abnormal work environment

2070.0	20700	50DC	Exceeds the upper limit
.	.	.	
.	.	.	
1820.1	18201	4719	Rated range
1820.0	18200	4718	
.	.	.	
.	.	.	
0.0	0		
<100.0	-32767	7FFF	Channel disabled
<100.0	-32768	8000	Underflow

Process Data Definition – N Type			
Temperature	Decimal	Hex	Location
>1550.0	32767	7FFF	Overflow
>1550.0	32766	7FFE	Break line
>1550.0	32765	7FFD	ADC chip fault
>1550.0	32764	7FFC	Module cold junction compensation sensor chip fault
>1550.0	32763	7FFB	Module cold junction compensation sensor abnormal work environment
1550.0	15500	3C8C	Exceeds the upper limit
.	.	.	
.	.	.	
1300.1	13001	32C9	Rated range
1300.0	13000	32C8	
.	.	.	
.	.	.	
-270.0	-2700	F574	
<-270.0	-32767	7FFF	Channel disabled
<-270.0	-32768	8000	Underflow

Note: The cold compensation sensor of the module is in an abnormal working environment, with the high temperature exceeding 110°C and the low temperature below -50°C。

6 Configuration parameters definition

Configuration parameter								
Bit No	Bit 7	Bit 6	Bit 5	Bit 4	Bit 3	Bit 2	Bit 1	Bit 0
Byte 0	Reserved					Temperature Unit		16Bit Data Format
Byte 1	TC Input Type (CH 1)				TC Input Type (CH 0)			
Byte 2	TC Input Type (CH 3)				TC Input Type (CH 2)			
Byte 3	TC Input Type (CH 5)				TC Input Type (CH 4)			
Byte 4	TC Input Type (CH 7)				TC Input Type (CH 6)			

Data description:

16Bit Data Format: 16 bit data bytes transfer data (Default:0):

0: A_B

1: B_A

Temperature Unit: temperature unit: (Default:0)

0: degree centigrade °C

1: Fahrenheit °F

2: Kelvin K

TC Input Type(CH 0-7): Sensor type of the channel:

0: Channel is disabled

1: J Type

2: K Type

3: E Type

4: T Type

5: S Type

6: R Type

7: B Type

8: N Type

9: C Type

 **WARNING**

UNEXPECTED EQUIPMENT OPERATION

The filtering parameters could be adjusted according to the field conditions. If the parameter settings are inappropriate, the signal will be lost.

Failure to follow instructions specified by the manufacturer may result in serious consequences such as death, personal injury, or damage to equipment since the protection provided by the equipment may be impaired.

 **AVERTISSEMENT**

FONCTIONNEMENT INATTENDU DE L'EQUIPEMENT

Les paramètres de filtrage peuvent être ajustés en fonction des conditions du site. Si les paramètres ne sont pas réglés correctement, la perte de signal se produira.

Le fait de ne pas suivre les instructions peut entraîner une défaillance de la protection fournie par l'équipement, ce qui peut entraîner des conséquences graves, comme des blessures ou des dommages à l'équipement.

V2.0 version

Configuration parameter									
Bit No	Bit 7	Bit 6	Bit 5	Bit 4	Bit 3	Bit 2	Bit 1	Bit 0	
Byte 0	Reserved					Temperature Unit		16Bit Data Format	
Byte 1	TC Input Type (CH 1)				TC Input Type (CH 0)				
Byte 2	TC Input Type (CH 3)				TC Input Type (CH 2)				
Byte 3	TC Input Type (CH 5)				TC Input Type (CH 4)				
Byte 4	TC Input Type (CH 7)				TC Input Type (CH 6)				
Byte 5	Filter_Level_CH1				Filter_Level_CH0				
Byte 6	Filter_Level_CH3				Filter_Level_CH2				
Byte 7	Filter_Level_CH5				Filter_Level_CH4				
Byte 8	Filter_Level_CH7				Filter_Level_CH6				
Byte 9	Reserved								

Data description:

16Bit Data Format: 16 bit data bytes transfer data (Default:0):

0: A_B

1: B_A

Temperature Unit: temperature unit: (Default:0)

0: degree centigrade °C

1: Fahrenheit °F

2: Kelvin K

TC Input Type(CH 0-3): Sensor type of the channel:

0: N/A

1: J Type

2: K Type

3: E Type

4: T Type

5: S Type

6: R Type

7: B Type

8: N Type

Filtering Level Ch (0-7): filter level. (Default: 1)

- 0: Level 0
- 1: Level 1
- 2: Level 2
- 3: Level 3
- 4: Level 4
- 5: Level 5
- 6: Level 6
- 7: Level 7
- 8: Level 8
- 9: Level 9
- 10: Level 10
- 11: Level 11
- 12: Level 12

 **WARNING**

UNEXPECTED EQUIPMENT OPERATION

The filtering parameters could be adjusted according to the field conditions. If the parameter settings are inappropriate, the signal will be lost.

Failure to follow instructions specified by the manufacturer may result in serious consequences such as death, personal injury, or damage to equipment since the protection provided by the equipment may be impaired.

 **AVERTISSEMENT**

FONCTIONNEMENT INATTENDU DE L'EQUIPEMENT

Les paramètres de filtrage peuvent être ajustés en fonction des conditions du site. Si les paramètres ne sont pas réglés correctement, la perte de signal se produira.

Le fait de ne pas suivre les instructions peut entraîner une défaillance de la protection fournie par l'équipement, ce qui peut entraîner des conséquences graves, comme des blessures ou des dommages à l'équipement.

A Dimension drawing

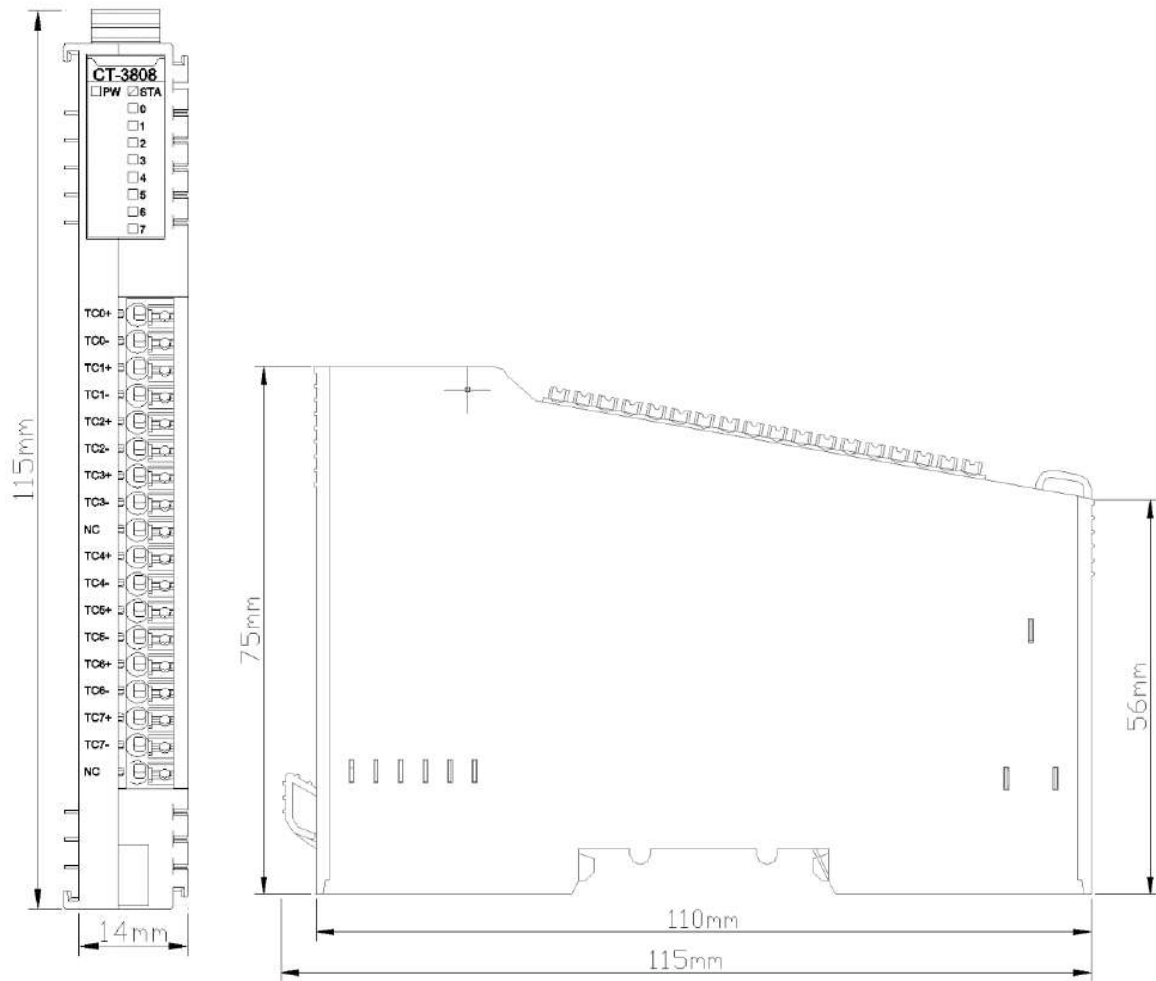

CT-3844 4 channels Analog Input, Thermocouple (TC-J/K/E/T/S/R/B/N) Types (filter adjustable)

1 Module features

- ◆ The module supports 4-channel thermocouple signal acquisition
- ◆ The module carries with 4 analog LED indicators
- ◆ The module supports 9 kinds of conventional thermocouple temperature measurement type
- ◆ The internal bus of the module and field input adopts magnetic isolation
- ◆ The module input channel supports TVS overvoltage protection
- ◆ 24-bit ADC resolution (Σ - δ type)
- ◆ The module supports adjustable filter parameters

2 Technical Parameters

General Parameters		
Power	Max.50mA@5.0Vdc	
Isolation	I/O to internal bus: magnetic isolation (2.5KVrms)	
Field Power	Not used	
Wiring	Max.: AWG 18	
Mounting Type	35mmDIN-Rail	
Size	115*14*75mm	
Weight	65g	
Environment Specification		
Operating Temperature of Horizontal Installation	-35°C~70°C	
Operating Temperature of Vertical Installation	-35°C~60°C	
Relative Humidity	< 95%RH (No Condensation)	
Storage Temperature	-40°C~85°C	
Storage Humidity	< 95%RH (No Condensation)	
Manufacturing Test Temperature	-40°C~75°C	
Ingress Protection Rating	IP20	
Input Parameter		
Channel Number	4 Channels	
LED Indicator	4 Input LED Indicators	
Sensor Type	J / K / E / T / S / R / B / N type thermocouples	
Acquisition Accuracy	±0.3% Full Scale, @25°C ±0.5% Full Scale, @-40~70°C	
Sampling Rate	70ms/4 channels	
Filter class	Adjustable	
Measuring Range °C	J Type	-210~1200°C
	K Type	-270~1370°C
	E Type	-270~1000°C
	T Type	-270~400°C
	S Type	-50~1760°C
	R Type	-50~1760°C
	B Type	0~1820°C
	N Type	-270~1300°C
Data Format	16-Bit Signed Integer (Integer)	
Diagnostic Function	-32767: No thermocouple model selected (that is, the channel is disabled) 32766: open circuit disconnection 32767: Temperature overflow -32768: Temperature underflow 32765: The ADC chip fault 32764: Cold-junction compensation transform fault value	

 **WARNING**

UNEXPECTED EQUIPMENT OPERATION

Do not exceed any of the ratings specified in the environmental and electrical characteristics table.

Failure to follow instructions specified by the manufacturer may result in serious consequences such as death, personal injury, or damage to equipment since the protection provided by the equipment may be impaired.

 **AVERTISSEMENT**

FONCTIONNEMENT INATTENDU DE L'EQUIPEMENT

Ne dépassez aucune évaluation spécifiée dans le tableau de caractéristiques environnementales et électriques..

Le fait de ne pas suivre les instructions peut entraîner une défaillance de la protection fournie par l'équipement, ce qui peut entraîner des conséquences graves, comme des blessures ou des dommages à l'équipement.

3 Hardware Interface

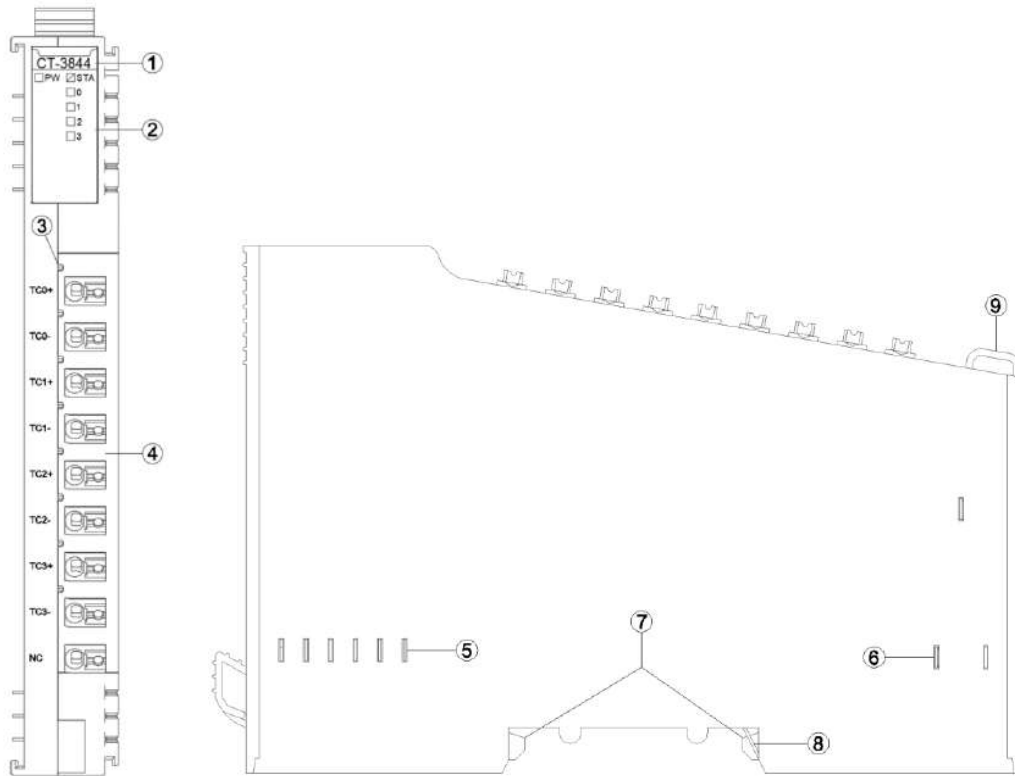

- ① Module Type
- ② State indicator
- ③ N/A
- ④ Wiring Terminal and identification
- ⑤ Internal Bus
- ⑥ Field Power
- ⑦ Buckle
- ⑧ Grounding Spring Sheet
- ⑨ Fixed Wiring Harness

3.1 LED LED indicator definition

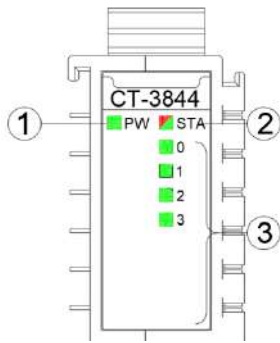

- ① Power LED indicator (green)
- ② Module State LED indicator (red/green)
- ③ Input channel LED indicator (green)

PW POWER STATE (GREEN)	Definition
ON	Internal bus Power Normal
OFF	Internal bus Power Failure
STA MODULE STATE (RED/GREEN)	Definition
Green slow flash (2.5Hz)	Module internal bus is not started
Red slow flash (2.5Hz)	Module internal bus offline
ON (GREEN)	Operation normal
Flash(2.5Hz) (RED/GREEN)	Upgrading mode
Flash(10Hz) (RED/GREEN)	Firmware Update
Double Flash (RED)	Module Exception has been soft-restarted
0-3 Channel Indicator	Definition
ON	The input signal exceeds 1% of the range
OFF	Invalid output signal

WARNING

UNEXPECTED EQUIPMENT OPERATION

By viewing the PW indicator, could determine the power supply status of a module. If the PW is steady green, the power supply is normal. Otherwise, the module cannot work properly.

When the module is initially powered on, there will be 3S for the backplane bus connection. After the backplane bus is initialized, STA is in the green steady state. If STA is in the green blinking state, it indicates that the backplane bus has not been initialized, and it needs to be powered off and restarted for re-initialization.

STA abnormal working state occurs during the normal operation of the module, please check the firmware version information of all modules, and consult ODOT technical support for details.
If a module is upgraded, check that all modules are in the normal state after the upgrade. Otherwise, an exception may occur.

Failure to follow instructions specified by the manufacturer may result in serious consequences such as death, personal injury, or damage to equipment since the protection provided by the equipment may be impaired.

AVERTISSEMENT

FONCTIONNEMENT INATTENDU DE L'EQUIPEMENT

En regardant l'état de l'indicateur de PW, jugez l'état d'alimentation du module. Le feu vert PW reste allumé et l'alimentation est normale. Autrement, le module ne fonctionnera pas correctement.

Lorsque le module est alimenté initialement, il y aura 3S pour la connexion de bus de backboard. STA est un état vert permanent après l'initialisation du bus de backboard. Si STA est en état de clignotement vert, cela signifie que l'initialisation du bus de backboard n'est pas passée et doit être redémarrée hors tension et réinitialisée.

L'état de fonctionnement anormal de STA se produit pendant le fonctionnement normal du module, veuillez vérifier les informations de version du firmware de tous les modules, et consulter le support technique ODOT pour plus de détails.

Si le module a une opération de mise à niveau, après l'achèvement de la mise à niveau, le besoin de vérifier que tous les modules sont dans l'état normal avant de courir, sinon il conduira à une exception.

Le fait de ne pas suivre les instructions peut entraîner une défaillance de la protection fournie par l'équipement, ce qui peut entraîner des conséquences graves, comme des blessures ou des dommages à l'équipement.

3.2 Terminal definition

Terminal Number	Definition	Description
1	TC0+	Signal Input CH0
2	TC0-	
3	TC1+	Signal Input CH1
4	TC1-	
5	TC2+	Signal Input CH2
6	TC2-	
7	TC3+	Signal Input CH3
8	TC3-	
9	NC	Not Connected

WARNING

UNEXPECTED EQUIPMENT OPERATION

Calculate the maximum field power current consumption of a single module based on the actual field load. If the total field power current consumption of all I/O modules exceeds the power supply capacity of the field power supply, you must add an extra power expansion module. Otherwise, an output channel exception may occur.

Failure to follow instructions specified by the manufacturer may result in serious consequences such as death, personal injury, or damage to equipment since the protection provided by the equipment may be impaired.

AVERTISSEMENT

FONCTIONNEMENT INATTENDU DE L'EQUIPEMENT

Calculez la consommation maximale de courant de champ d'un seul module en fonction de la charge de champ réelle. Si la consommation totale de courant de champ de tous les modules d'E/S dépasse la capacité d'alimentation de l'alimentation de champ, vous devez ajouter un module d'extension de puissance supplémentaire. Dans le cas contraire, une exception de canal de sortie peut se produire.

Le fait de ne pas suivre les instructions peut entraîner une défaillance de la protection fournie par l'équipement, ce qui peut entraîner des conséquences graves, comme des blessures ou des dommages à l'équipement.

When connecting a cold-pressed terminal, the terminal must be terminated and checked in strict accordance with the corresponding termination specifications or requirements, and connect the cold-pressed terminal according to the corresponding node serial number. The conductor should use copper conductor and the conductor core should be

larger than 0.2mm^2 and smaller than 1mm^2 (AWG18~AWG24). Cold-pressed terminal parameters are as follows:

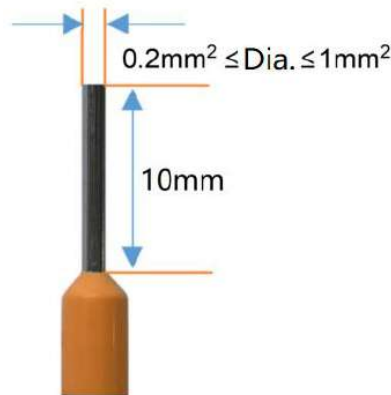

! WARNING

UNEXPECTED EQUIPMENT OPERATION

Strip the length of the conductor insulation layer is greater than 10mm to ensure reliable signal connection.

The wire needs to use copper wire and the wire core is greater than or equal to 0.2mm^2 and less than or equal to 1mm^2 to ensure reliable signal connection.

When connecting a cold-press terminal, connect the cold-press terminal strictly in accordance with the corresponding termination specifications or requirements, and connect the cold-press terminal according to the corresponding node serial number.

Do not power on cold-press terminals until they are properly connected or fully locked.

Failure to follow instructions specified by the manufacturer may result in serious consequences such as death, personal injury, or damage to equipment since the protection provided by the equipment may be impaired.

! AVERTISSEMENT

FONCTIONNEMENT INATTENDU DE L'EQUIPEMENT

Dépouillez la longueur de la couche isolante du fil plus de 10mm pour assurer la connexion fiable du signal.

Le conducteur doit utiliser le fil de cuivre et le noyau de fil est supérieur ou égal à $0,2\text{ mm}^2$, inférieur ou égal à 1mm^2 , afin d'assurer la connexion fiable du signal.

Lorsque les terminaux de presse à froid sont terminés, ils doivent être terminés et visualisés en stricte conformité avec les spécifications ou les exigences correspondantes et terminés selon le numéro de série de noeud correspondant.

Il est interdit d'activer les bornes à froid avant qu'elles ne soient correctement articulées ou

complètement verrouillées.

Le fait de ne pas suivre les instructions peut entraîner une défaillance de la protection fournie par l'équipement, ce qui peut entraîner des conséquences graves, comme des blessures ou des dommages à l'équipement.

DANGER

FIRE DANGER

Use the correct wiring rules only for the maximum current capacity of the I/O channel and power supply.

Failure to follow instructions specified by the manufacturer may result in serious consequences such as death, personal injury, or damage to equipment since the protection provided by the equipment may be impaired.

WARNING

UNEXPECTED EQUIPMENT OPERATION

Do not exceed any of the ratings specified in the environmental and electrical characteristics table.

Failure to follow instructions specified by the manufacturer may result in serious consequences such as death, personal injury, or damage to equipment since the protection provided by the equipment may be impaired.

AVERTISSEMENT

FONCTIONNEMENT INATTENDU DE L'EQUIPEMENT

Ne dépassez aucune évaluation spécifiée dans le tableau de caractéristiques environnementales et électriques..

Le fait de ne pas suivre les instructions peut entraîner une défaillance de la protection fournie par l'équipement, ce qui peut entraîner des conséquences graves, comme des blessures ou des dommages à l'équipement.

4 Wiring

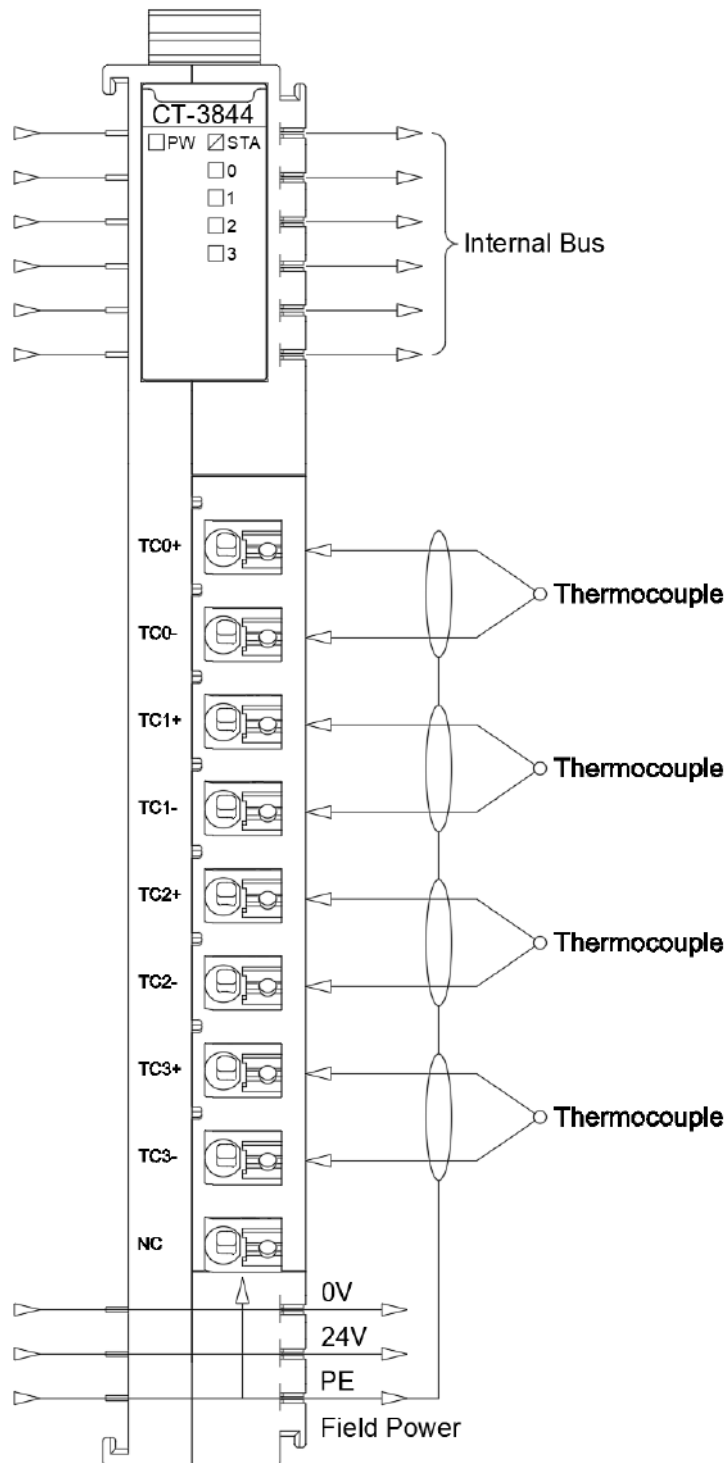

⚠ WARNING

UNEXPECTED EQUIPMENT OPERATION

Do not link wires to unused terminals and/or terminals marked "NO CONNECTION (NC)".

Failure to follow instructions specified by the manufacturer may result in serious

consequences such as death, personal injury, or damage to equipment since the protection provided by the equipment may be impaired.

AVERTISSEMENT

FONCTIONNEMENT INATTENDU DE L'EQUIPEMENT

Ne liez pas les fils aux bornes inutilisées et/ou aux bornes marquées «NO CONNECTION (NC)».

Le fait de ne pas suivre les instructions peut entraîner une défaillance de la protection fournie par l'équipement, ce qui peut entraîner des conséquences graves, comme des blessures ou des dommages à l'équipement.

NOTICE

EQUIPMENT INOPERABLE

Do not crimp the spring terminal with more than the maximum pressure specified for the terminal. Otherwise, the resilience of the spring terminal may be damaged and the terminal rebound may be affected.

Do not press the spring terminal with a sharp tool when removing cable from the channel. Otherwise, the spring terminal will be damaged.

Failure to follow these instructions may result in equipment damage.

5 Process data definition

Input Data								
Bit No	Bit 7	Bit 6	Bit 5	Bit 4	Bit 3	Bit 2	Bit 1	Bit 0
Byte 0	Analog Input Data (CH 0)							
Byte 1								
Byte 2	Analog Input Data (CH 1)							
Byte 3								
Byte 4	Analog Input Data (CH 2)							
Byte 5								
Byte 6	Analog Input Data (CH 3)							
Byte 7								

Data description:

Analog Input Data (CH0-3): The current temperature acquisition value of the corresponding channel

Process Data Definition - J Type			
Temperature	Decimal	Hex	Location
>1360.0	32767	7FFF	Overflow
>1360.0	32766	7FFE	Break line
>1360.0	32765	7FFD	ADC chip fault
>1360.0	32764	7FFC	Module cold junction compensation sensor chip fault
>1360.0	32763	7FFB	Module cold junction compensation sensor abnormal work environment
1360.0	13600	3520	Exceeds the upper limit
.	.	.	
.	.	.	
1200.1	12001	2EE1	Rated range
1200.0	12000	2EE0	
.	.	.	
.	.	.	
-210.0	-2100	F7CC	Channel disabled
<-210.0	-32767	7FFF	
<-210.0	-32768	8000	
			Underflow

Process Data Definition - K Type			
Temperature	Decimal	Hex	Location
>1622.0	32767	7FFF	Overflow
>1622.0	32766	7FFE	Break line
>1622.0	32765	7FFD	ADC chip fault
>1622.0	32764	7FFC	Module cold junction compensation sensor chip fault
>1622.0	32763	7FFB	Module cold junction compensation sensor abnormal work environment
1622.0	16220	3F5C	Exceeds the upper limit
.	.	.	
.	.	.	
1372.1	13721	3599	
1372.0	13720	3598	Rated range
.	.	.	
.	.	.	
-270.0	-2700	F574	
<-270.0	-32767	7FFF	Channel disabled
<-270.0	-32768	8000	Underflow

Process Data Definition – E Type			
Temperature	Decimal	Hex	Location
>1200.0	32767	7FFF	Overflow
>1200.0	32766	7FFE	Break line
>1200.0	32765	7FFD	ADC chip fault
>1200.0	32764	7FFC	Module cold junction compensation sensor chip fault
>1200.0	32763	7FFB	Module cold junction compensation sensor abnormal

			work environment
1200.0	12000	2EE0	Exceeds the upper limit
.	.	.	
.	.	.	
1000.1	10001	2711	Rated range
1000.0	10000	2710	
.	.	.	
.	.	.	
-270.0	-2700	F574	Channel disabled
<-270.0	-32767	7FFF	
<-270.0	-32768	8000	Underflow

Process Data Definition –T Type			
Temperature	Decimal	Hex	Location
>540.0	32767	7FFF	Overflow
>540.0	32766	7FFE	Break line
>540.0	32765	7FFD	ADC chip fault
>540.0	32764	7FFC	Module cold junction compensation sensor chip fault
>540.0	32763	7FFB	Module cold junction compensation sensor abnormal work environment
540.0	5400	1518	Exceeds the upper limit
.	.	.	
.	.	.	
400.1	4001	FA1	Rated range
400.0	4000	FA0	
.	.	.	
.	.	.	
-270.0	-2700	F574	Channel disabled
<-270.0	-32767	7FFF	
<-270.0	-32768	8000	Underflow

Process Data Definition –S Type

Temperature	Decimal	Hex	Location
>1800.0	32767	7FFF	Overflow
>1800.0	32766	7FFE	Break line
>1800.0	32765	7FFD	ADC chip fault
>1800.0	32764	7FFC	Module cold junction compensation sensor chip fault
>1800.0	32763	7FFB	Module cold junction compensation sensor abnormal work environment
1850.0	18500	4844	Exceeds the upper limit
.	.	.	
.	.	.	
1769.1	17691	451B	Rated range
1769.0	17690	451A	
.	.	.	
.	.	.	
-50.0	-500	FE0C	Exceeds the lower limit
-50.1	-501	FE0B	
.	.	.	
.	.	.	
-170.0	-1700	F95C	Channel disabled
<-170.0	-32767	7FFF	
<-170.0	-32768	8000	Underflow

Process Data Definition – R Type			
Temperature	Decimal	Hex	Location
>1940.0	32767	7FFF	Overflow
>1940.0	32766	7FFE	Break line
>1940.0	32765	7FFD	ADC chip fault
>1940.0	32764	7FFC	Module cold junction compensation sensor chip fault
>1940.0	32763	7FFB	Module cold junction compensation sensor abnormal work environment
2019.0	20190	4EDE	Exceeds the upper limit
.	.	.	
.	.	.	
1769.1	17691	451B	Rated range
1769.0	17690	451A	
.	.	.	
.	.	.	
-50.0	-500	FE0C	Exceeds the lower limit
-50.1	-501	FE0B	
.	.	.	
.	.	.	
-170.0	-1700	F95C	Channel disabled
<-110.0	-32767	7FFF	
<-110.0	-32768	8000	Underflow

Process Data Definition - B Type			
Temperature	Decimal	Hex	Location
>2070.0	32767	7FFF	Overflow
>2070.0	32766	7FFE	Break line
>2070.0	32765	7FFD	ADC chip fault
>2070.0	32764	7FFC	Module cold junction compensation sensor chip fault
>2070.0	32763	7FFB	Module cold junction

			compensation sensor abnormal work environment
2070.0	20700	50DC	Exceeds the upper limit
.	.	.	
.	.	.	
1820.1	18201	4719	Rated range
1820.0	18200	4718	
.	.	.	
.	.	.	
0.0	0		
<100.0	-32767	7FFF	Channel disabled
<100.0	-32768	8000	Underflow

Process Data Definition – N Type			
Temperature	Decimal	Hex	Location
>1550.0	32767	7FFF	Overflow
>1550.0	32766	7FFE	Break line
>1550.0	32765	7FFD	ADC chip fault
>1550.0	32764	7FFC	Module cold junction compensation sensor chip fault
>1550.0	32763	7FFB	Module cold junction compensation sensor abnormal work environment
1550.0	15500	3C8C	Exceeds the upper limit
.	.	.	
.	.	.	
1300.1	13001	32C9	Rated range
1300.0	13000	32C8	
.	.	.	
.	.	.	
-270.0	-2700	F574	
<-270.0	-32767	7FFF	Channel disabled
<-270.0	-32768	8000	Underflow

6 Configuration parameters definition

Configuration Parameter									
Bit No	Bit 7	Bit 6	Bit 5	Bit 4	Bit 3	Bit 2	Bit 1	Bit 0	
Byte 0	Reserved					Temperature Unit		16Bit Data Format	
Byte 1	CJC Model (CH 3)		CJC Model (CH 2)		CJC Model (CH 1)		CJC Model (CH 0)		
Byte 2	TC Input Type (CH 1)				TC Input Type (CH 0)				
Byte 3	TC Input Type (CH 3)				TC Input Type (CH 2)				
Byte 4	Filtering Level (CH 1)				Filtering Level (CH 0)				
Byte 5	Filtering Level (CH 3)				Filtering Level (CH 2)				

Data description:

16Bit Data Format: Big-endian and little-endian format of data upload

0: A_B

1: B_A

Temperature Unit: (Default: 0)

0: Degrees Celsius°C

1: Fahrenheit°F

2: Kelvin (K-)

CJC Model(CH 0-3): cold junction compensation mode (Default: 0)

0: Internal reference junction

1: Fixed reference temperature. 0°C

TC Input Type(CH 0-3): Sensor type of the channel (Default: 0: N/A)

0: N/A

1: J type

2: K type

3: E type

4: T type

5: S type

6: R type

7: B type

8: N type

Filtering Level Ch (0-3): Filter level (Default: 4)

- 0: Level 0
- 1: Level 1
- 2: Level 2
- 3: Level 3
- 4: Level 4
- 5: Level 5
- 6: Level 6
- 7: Level 7
- 8: Level 8
- 9: Level 9
- 10: Level 10
- 11: Level 11
- 12: Level 12

 **WARNING**

UNEXPECTED EQUIPMENT OPERATION

The filtering parameters could be adjusted according to the field conditions. If the parameter settings are inappropriate, the signal will be lost.

Failure to follow instructions specified by the manufacturer may result in serious consequences such as death, personal injury, or damage to equipment since the protection provided by the equipment may be impaired.

 **AVERTISSEMENT**

FONCTIONNEMENT INATTENDU DE L'EQUIPEMENT

Les paramètres de filtrage peuvent être ajustés en fonction des conditions du site. Si les paramètres ne sont pas réglés correctement, la perte de signal se produira.

Le fait de ne pas suivre les instructions peut entraîner une défaillance de la protection fournie par l'équipement, ce qui peut entraîner des conséquences graves, comme des blessures ou des dommages à l'équipement.

A Dimension drawing

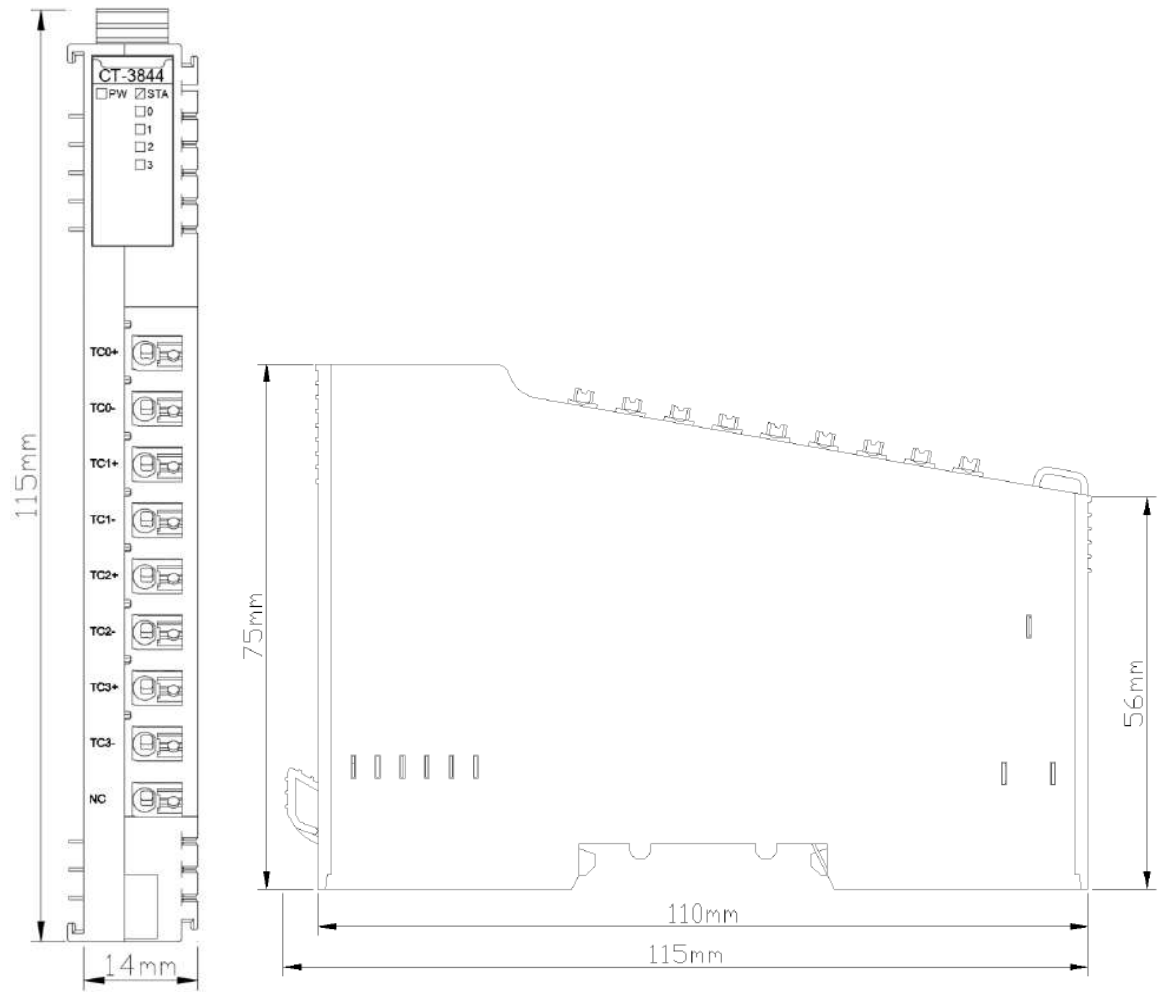

CT-3848 8 channels Analog Input Thermocouple (TC-J/K/E/T/S/R/B/N) types (filter adjustable)

1 Module features

- ◆ The module supports 8-channel thermocouple signal acquisition
- ◆ The module carries with 8 analog LED indicators
- ◆ The module supports 9 kinds of conventional thermocouple temperature measurement type
- ◆ The internal bus of the module and field input adopts magnetic isolation
- ◆ The module input channel supports TVS overvoltage protection
- ◆ 24-bit ADC resolution (Σ - δ type)
- ◆ The module supports adjustable filter parameters

2 Technical Parameters

General Parameters		
Power	Max.60mA@5.0Vdc	
Isolation	I/O to internal bus; magnetic isolation (2.5KVrms)	
Field Power	Not used	
Wiring	Max.: AWG 18	
Mounting Type	35mm Din-Rail	
Size	115*14*75mm	
Weight	65g	
Environment Specification		
Operating Temperature of Horizontal Installation	-35°C~70°C	
Operating Temperature of Vertical Installation	-35°C~60°C	
Relative Humidity	< 95%RH (No Condensation)	
Storage Temperature	-40°C~85°C	
Storage Humidity	< 95%RH (No Condensation)	
Manufacturing Test Temperature	-40°C~75°C	
Ingress Protection Rating	IP20	
Input Parameter		
Channel Number	8 Channels	
LED Indicator	8 Input LED Indicators	
Sensor Type	J / K / E / T / S / R / B / N thermocouples	
Acquisition Accuracy	±0.3% Full Scale, @25°C ±0.5% Full Scale, @-40~70°C	
Sampling Rate	70ms/4 channel	
Filter Level	Adjustable	
Measuring Range °C	J type	-210~1200°C
	K type	-270~1370°C
	E type	-270~1000°C
	T type	-270~400°C
	S type	-50~1760°C
	R type	-50~1760°C
	B type	0~1820°C
	N type	-270~1300°C
Data Format	16-Bit Signed Integer (Integer)	
Diagnostic Function	-32767: No thermocouple model selected (that is, the channel is disabled) 32766: open circuit disconnection 32767: Temperature overflow -32768: Temperature underflow 32765: The ADC chip fault 32764: Cold-junction compensation transform fault value	

 **WARNING**

UNEXPECTED EQUIPMENT OPERATION

Do not exceed any of the ratings specified in the environmental and electrical characteristics table.

Failure to follow instructions specified by the manufacturer may result in serious consequences such as death, personal injury, or damage to equipment since the protection provided by the equipment may be impaired.

 **AVERTISSEMENT**

FONCTIONNEMENT INATTENDU DE L'EQUIPEMENT

Ne dépassez aucune évaluation spécifiée dans le tableau de caractéristiques environnementales et électriques..

Le fait de ne pas suivre les instructions peut entraîner une défaillance de la protection fournie par l'équipement, ce qui peut entraîner des conséquences graves, comme des blessures ou des dommages à l'équipement.

3 Hardware Interface

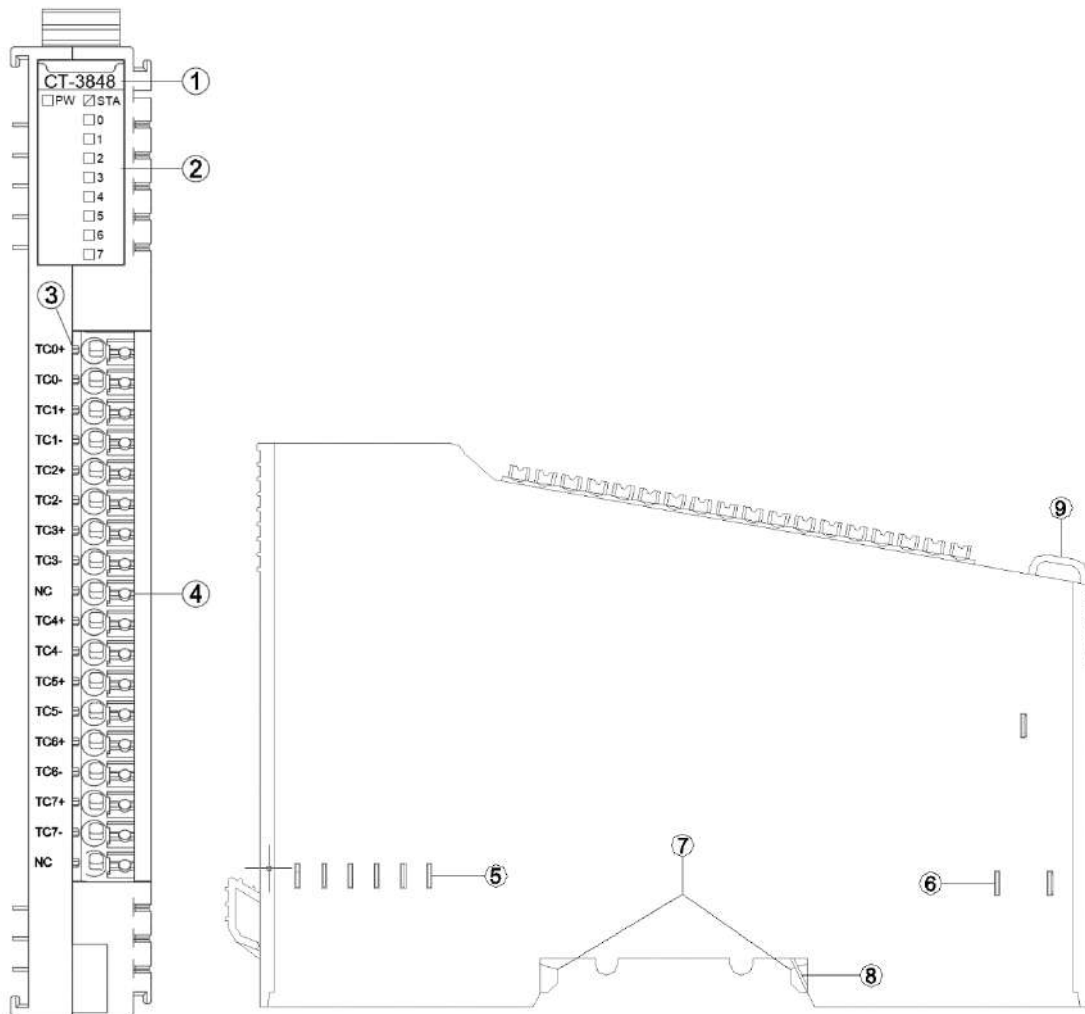

- ① Module Type
- ② State indicator
- ③ N/A
- ④ Wiring Terminal and identification
- ⑤ Internal Bus
- ⑥ Field Power
- ⑦ Buckle
- ⑧ Grounding Spring Sheet
- ⑨ Fixed Wiring Harness

3.1 LED Indicator definition

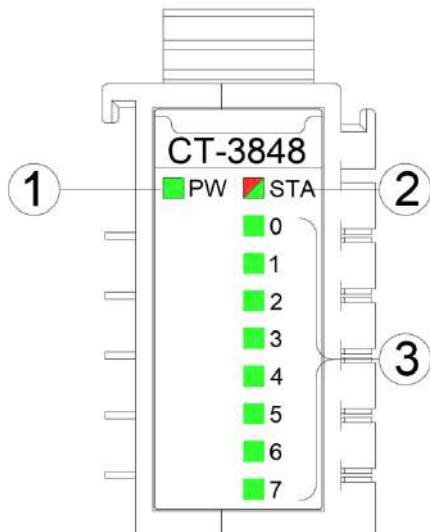

- ① Power LED indicator (green)
- ② Module State LED indicator (red/green)
- ③ Input channel LED indicator (green)

PW POWER STATE (GREEN)	Definition
ON	Internal bus Power Normal
OFF	Internal bus Power Failure
STA MODULE STATE (RED/GREEN)	Definition
Green slow flash (2.5Hz)	Module internal bus is not started
Red slow flash (2.5Hz)	Module internal bus offline
ON (GREEN)	Operation normal
Flash(2.5Hz) (RED/GREEN)	Upgrading mode
Flash(10Hz) (RED/GREEN)	Firmware Update
Double Flash (RED)	Module Exception, has been soft-restarted
0-7 Channel Indicator	Definition
ON	The input signal exceeds 1% of the range
OFF	Invalid output signal

⚠️ WARNING

UNEXPECTED EQUIPMENT OPERATION

By viewing the PW indicator, could determine the power supply status of a module. If the PW is steady green, the power supply is normal. Otherwise, the module cannot work properly.

When the module is initially powered on, there will be 3S for the backplane bus connection. After

the backplane bus is initialized, STA is in the green steady state. If STA is in the green blinking state, it indicates that the backplane bus has not been initialized, and it needs to be powered off and restarted for re-initialization.

STA abnormal working state occurs during the normal operation of the module, please check the firmware version information of all modules, and consult ODOT technical support for details.

If a module is upgraded, check that all modules are in the normal state after the upgrade. Otherwise, an exception may occur.

Failure to follow instructions specified by the manufacturer may result in serious consequences such as death, personal injury, or damage to equipment since the protection provided by the equipment may be impaired.

AVERTISSEMENT

FONCTIONNEMENT INATTENDU DE L'EQUIPEMENT

En regardant l'état de l'indicateur de PW, jugez l'état d'alimentation du module. Le feu vert PW reste allumé et l'alimentation est normale. Autrement, le module ne fonctionnera pas correctement.

Lorsque le module est alimenté initialement, il y aura 3S pour la connexion de bus de backboard. STA est un état vert permanent après l'initialisation du bus de backboard. Si STA est en état de clignotement vert, cela signifie que l'initialisation du bus de backboard n'est pas passée et doit être redémarrée hors tension et réinitialisée.

L'état de fonctionnement anormal de STA se produit pendant le fonctionnement normal du module, veuillez vérifier les informations de version du firmware de tous les modules, et consulter le support technique ODOT pour plus de détails.

Si le module a une opération de mise à niveau, après l'achèvement de la mise à niveau, le besoin de vérifier que tous les modules sont dans l'état normal avant de courir, sinon il conduira à une exception.

Le fait de ne pas suivre les instructions peut entraîner une défaillance de la protection fournie par l'équipement, ce qui peut entraîner des conséquences graves, comme des blessures ou des dommages à l'équipement.

3.2 Terminal definition

Terminal Number	Definition	Description
1	TC0+	Signal Input CH0
2	TC0-	
3	TC1+	Signal Input CH1
4	TC1-	
5	TC2+	Signal Input CH2
6	TC2-	
7	TC3+	Signal Input CH3
8	TC3-	
9	NC	Not connected
10	TC4+	Signal Input CH4
11	TC4-	
12	TC5+	Signal Input CH5
13	TC5-	
14	TC6+	Signal Input CH6
15	TC6-	
16	TC7+	Signal Input CH7
17	TC7-	
18	NC	Not connected

WARNING

UNEXPECTED EQUIPMENT OPERATION

Calculate the maximum field power current consumption of a single module based on the actual field load. If the total field power current consumption of all I/O modules exceeds the power supply capacity of the field power supply, you must add an extra power expansion module. Otherwise, an output channel exception may occur.

Failure to follow instructions specified by the manufacturer may result in serious consequences such as death, personal injury, or damage to equipment since the protection provided by the equipment may be impaired.

AVERTISSEMENT

FONCTIONNEMENT INATTENDU DE L'EQUIPEMENT

Calculez la consommation maximale de courant de champ d'un seul module en fonction de la charge de champ réelle. Si la consommation totale de courant de champ de tous les modules d'E/S dépasse la capacité d'alimentation de l'alimentation de champ, vous devez ajouter un module d'extension de puissance supplémentaire. Dans le cas contraire, une exception de canal de sortie peut se produire.

Le fait de ne pas suivre les instructions peut entraîner une défaillance de la protection fournie par l'équipement, ce qui peut entraîner des conséquences graves, comme des blessures ou des dommages à l'équipement.

When connecting a cold-pressed terminal, the terminal must be terminated and checked in strict accordance with the corresponding termination specifications or requirements, and connect the cold-pressed terminal according to the corresponding node serial number. The conductor should use copper conductor and the conductor core should be larger than 0.2mm^2 and smaller than 1mm^2 (AWG18~AWG24). Cold-pressed terminal parameters are as follows:

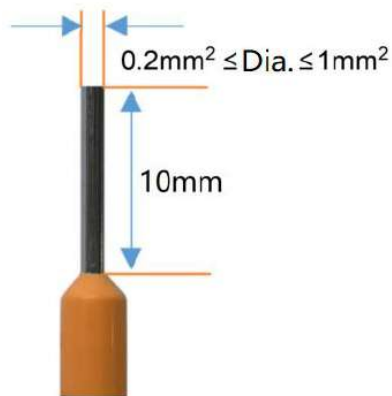

! WARNING

UNEXPECTED EQUIPMENT OPERATION

Strip the length of the conductor insulation layer is greater than 10mm to ensure reliable signal connection.

The wire needs to use copper wire and the wire core is greater than or equal to 0.2mm^2 and less than or equal to 1mm^2 to ensure reliable signal connection.

When connecting a cold-press terminal, connect the cold-press terminal strictly in accordance with the corresponding termination specifications or requirements, and connect the cold-press terminal according to the corresponding node serial number.

Do not power on cold-press terminals until they are properly connected or fully locked.

Failure to follow instructions specified by the manufacturer may result in serious consequences such as death, personal injury, or damage to equipment since the protection provided by the equipment may be impaired.

! AVERTISSEMENT

FONCTIONNEMENT INATTENDU DE L'EQUIPEMENT

Dépouillez la longueur de la couche isolante du fil plus de 10mm pour assurer la connexion fiable du signal.

Le conducteur doit utiliser le fil de cuivre et le noyau de fil est supérieur ou égal à $0,2\text{ mm}^2$, inférieur ou égal à 1mm^2 , afin d'assurer la connexion fiable du signal.

Lorsque les terminaux de presse à froid sont terminés, ils doivent être terminés et visualisés en stricte conformité avec les spécifications ou les exigences correspondantes et terminés selon le numéro de série de noeud correspondant.

Il est interdit d'activer les bornes à froid avant qu'elles ne soient correctement articulées ou complètement verrouillées.

Le fait de ne pas suivre les instructions peut entraîner une défaillance de la protection fournie par l'équipement, ce qui peut entraîner des conséquences graves, comme des blessures ou des dommages à l'équipement.

DANGER

FIRE DANGER

Use the correct wiring rules only for the maximum current capacity of the I/O channel and power supply.

Failure to follow instructions specified by the manufacturer may result in serious consequences such as death, personal injury, or damage to equipment since the protection provided by the equipment may be impaired.

WARNING

UNEXPECTED EQUIPMENT OPERATION

Do not exceed any of the ratings specified in the environmental and electrical characteristics table.

Failure to follow instructions specified by the manufacturer may result in serious consequences such as death, personal injury, or damage to equipment since the protection provided by the equipment may be impaired.

AVERTISSEMENT

FONCTIONNEMENT INATTENDU DE L'EQUIPEMENT

Ne dépassez aucune évaluation spécifiée dans le tableau de caractéristiques environnementales et électriques..

Le fait de ne pas suivre les instructions peut entraîner une défaillance de la protection fournie par l'équipement, ce qui peut entraîner des conséquences graves, comme des blessures ou des dommages à l'équipement.

4 Wiring

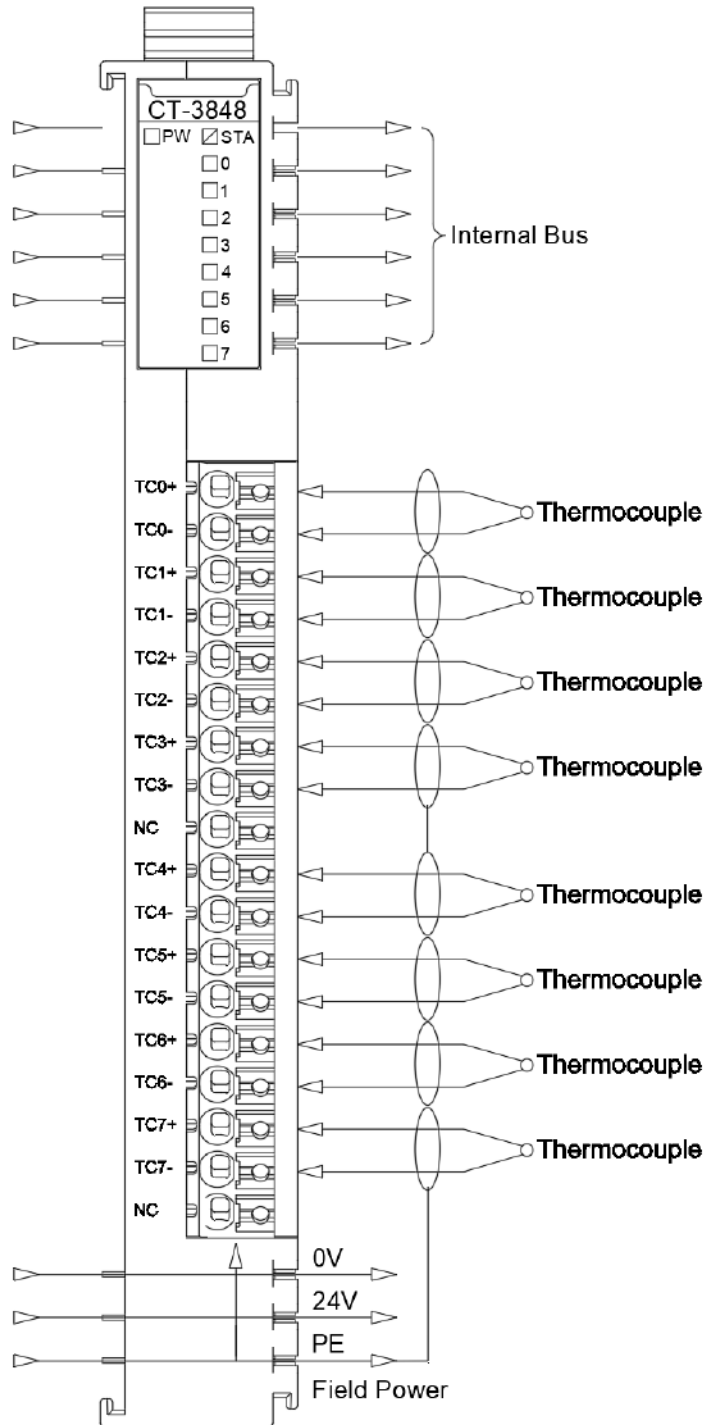

⚠️ WARNING

UNEXPECTED EQUIPMENT OPERATION

Do not link wires to unused terminals and/or terminals marked "NO CONNECTION (NC)".

Failure to follow instructions specified by the manufacturer may result in serious consequences such as death, personal injury, or damage to equipment since the protection

provided by the equipment may be impaired.

AVERTISSEMENT

FONCTIONNEMENT INATTENDU DE L'EQUIPEMENT

Ne liez pas les fils aux bornes inutilisées et/ou aux bornes marquées «NO CONNECTION (NC)».

Le fait de ne pas suivre les instructions peut entraîner une défaillance de la protection fournie par l'équipement, ce qui peut entraîner des conséquences graves, comme des blessures ou des dommages à l'équipement.

NOTICE

EQUIPMENT INOPERABLE

Do not crimp the spring terminal with more than the maximum pressure specified for the terminal. Otherwise, the resilience of the spring terminal may be damaged and the terminal rebound may be affected.

Do not press the spring terminal with a sharp tool when removing cable from the channel. Otherwise, the spring terminal will be damaged.

Failure to follow these instructions may result in equipment damage.

5 Process data definition

Input Data								
Bit No	Bit 7	Bit 6	Bit 5	Bit 4	Bit 3	Bit 2	Bit 1	Bit 0
Byte 0	Analog Input Data (CH 0)							
Byte 1								
Byte 2	Analog Input Data (CH 1)							
Byte 3								
Byte 4	Analog Input Data (CH 2)							
Byte 5								
Byte 6	Analog Input Data (CH 3)							
Byte 7								
Byte 8	Analog Input Data (CH 4)							
Byte 9								
Byte 10	Analog Input Data (CH 5)							
Byte 11								
Byte 12	Analog Input Data (CH 6)							
Byte 13								
Byte 14	Analog Input Data (CH 7)							
Byte 15								

Data description:

Analog Input Data (CH0-3): The current temperature acquisition value of the corresponding channel

Process Data Definition - J Type			
Temperature	Decimal	Hex	Location
>1360.0	32767	7FFF	Overflow
>1360.0	32766	7FFE	Break line
>1360.0	32765	7FFD	ADC chip fault
>1360.0	32764	7FFC	Module cold junction compensation sensor chip fault
>1360.0	32763	7FFB	Module cold junction compensation sensor abnormal work environment
1360.0	13600	3520	Exceeds the upper limit
.	.	.	
.	.	.	
1200.1	12001	2EE1	Rated range
1200.0	12000	2EE0	

.	.	.	
.	.	.	
-210.0	-2100	F7CC	
<-210.0	-32767	7FFF	Channel disabled
<-210.0	-32768	8000	Underflow

Process Data Definition - K Type			
Temperature	Decimal	Hex	Location
>1622.0	32767	7FFF	Overflow
>1622.0	32766	7FFE	Break line
>1622.0	32765	7FFD	ADC chip fault
>1622.0	32764	7FFC	Module cold junction compensation sensor chip fault
>1622.0	32763	7FFB	Module cold junction compensation sensor abnormal work environment
1622.0	16220	3F5C	Exceeds the upper limit
.	.	.	
.	.	.	
1372.1	13721	3599	
1372.0	13720	3598	Rated range
.	.	.	
.	.	.	
-270.0	-2700	F574	
<-270.0	-32767	7FFF	Channel disabled
<-270.0	-32768	8000	Underflow

Process Data Definition – E Type			
Temperature	Decimal	Hex	Location
>1200.0	32767	7FFF	Overflow
>1200.0	32766	7FFE	Break line
>1200.0	32765	7FFD	ADC chip fault
>1200.0	32764	7FFC	Module cold junction

			compensation sensor chip fault
>1200.0	32763	7FFB	Module cold junction compensation sensor abnormal work environment
1200.0	12000	2EE0	Exceeds the upper limit
.	.	.	
.	.	.	
1000.1	10001	2711	Rated range
1000.0	10000	2710	
.	.	.	
.	.	.	
-270.0	-2700	F574	Channel disabled
<-270.0	-32767	7FFF	
<-270.0	-32768	8000	Underflow

Process Data Definition –T Type			
Temperature	Decimal	Hex	Location
>540.0	32767	7FFF	Overflow
>540.0	32766	7FFE	Break line
>540.0	32765	7FFD	ADC chip fault
>540.0	32764	7FFC	Module cold junction compensation sensor chip fault
>540.0	32763	7FFB	Module cold junction compensation sensor abnormal work environment
540.0	5400	1518	Exceeds the upper limit
.	.	.	
.	.	.	
400.1	4001	FA1	Rated range
400.0	4000	FA0	
.	.	.	
.	.	.	

-270.0	-2700	F574	
<-270.0	-32767	7FFF	Channel disabled
<-270.0	-32768	8000	Underflow

Process Data Definition –S Type			
Temperature	Decimal	Hex	Location
>1800.0	32767	7FFF	Overflow
>1800.0	32766	7FFE	Break line
>1800.0	32765	7FFD	ADC chip fault
>1800.0	32764	7FFC	Module cold junction compensation sensor chip fault
>1800.0	32763	7FFB	Module cold junction compensation sensor abnormal work environment
1850.0	18500	4844	Exceeds the upper limit
.	.	.	
.	.	.	
1769.1	17691	451B	Rated range
1769.0	17690	451A	
.	.	.	
.	.	.	
-50.0	-500	FE0C	Exceeds the lower limit
-50.1	-501	FE0B	
.	.	.	
.	.	.	
-170.0	-1700	F95C	
<-170.0	-32767	7FFF	Channel disabled
<-170.0	-32768	8000	Underflow

Process Data Definition – R Type			
Temperature	Decimal	Hex	Location
>1940.0	32767	7FFF	Overflow
>1940.0	32766	7FFE	Break line
>1940.0	32765	7FFD	ADC chip fault
>1940.0	32764	7FFC	Module cold junction compensation sensor chip fault
>1940.0	32763	7FFB	Module cold junction compensation sensor abnormal work environment
2019.0	20190	4EDE	Exceeds the upper limit
.	.	.	
.	.	.	
1769.1	17691	451B	Rated range
1769.0	17690	451A	
.	.	.	
.	.	.	
-50.0	-500	FE0C	Exceeds the lower limit
-50.1	-501	FE0B	
.	.	.	
.	.	.	
-170.0	-1700	F95C	Channel disabled
<-110.0	-32767	7FFF	
<-110.0	-32768	8000	Underflow

Process Data Definition - B Type			
Temperature	Decimal	Hex	Location
>2070.0	32767	7FFF	Overflow
>2070.0	32766	7FFE	Break line
>2070.0	32765	7FFD	ADC chip fault
>2070.0	32764	7FFC	Module cold junction compensation sensor chip fault
>2070.0	32763	7FFB	Module cold junction

			compensation sensor abnormal work environment
2070.0	20700	50DC	Exceeds the upper limit
.	.	.	
.	.	.	
1820.1	18201	4719	Rated range
1820.0	18200	4718	
.	.	.	
.	.	.	
0.0	0		
<100.0	-32767	7FFF	Channel disabled
<100.0	-32768	8000	Underflow

Process Data Definition – N Type			
Temperature	Decimal	Hex	Location
>1550.0	32767	7FFF	Overflow
>1550.0	32766	7FFE	Break line
>1550.0	32765	7FFD	ADC chip fault
>1550.0	32764	7FFC	Module cold junction compensation sensor chip fault
>1550.0	32763	7FFB	Module cold junction compensation sensor abnormal work environment
1550.0	15500	3C8C	Exceeds the upper limit
.	.	.	
.	.	.	
1300.1	13001	32C9	Rated range
1300.0	13000	32C8	
.	.	.	
.	.	.	
-270.0	-2700	F574	
<-270.0	-32767	7FFF	Channel disabled
<-270.0	-32768	8000	Underflow

6 Configuration parameters definition

Configuration parameters								
Bit No	Bit 7	Bit 6	Bit 5	Bit 4	Bit 3	Bit 2	Bit 1	Bit 0
Byte 0	Reserved					Temperature Unit		16Bit Data Format
Byte 1	CJC Model (CH 3)		CJC Model (CH 2)		CJC Model (CH 1)		CJC Model (CH 0)	
Byte 2	CJC Model (CH 7)		CJC Model (CH 6)		CJC Model (CH 5)		CJC Model (CH 4)	
Byte 3	TC Input Type (CH 1)				TC Input Type (CH 0)			
Byte 4	TC Input Type (CH 3)				TC Input Type (CH 2)			
Byte 5	TC Input Type (CH 5)				TC Input Type (CH 4)			
Byte 6	TC Input Type (CH 7)				TC Input Type (CH 6)			
Byte 7	Filtering Level (CH 1)				Filtering Level (CH 0)			
Byte 8	Filtering Level (CH 3)				Filtering Level (CH 2)			
Byte 9	Filtering Level (CH 5)				Filtering Level (CH 4)			
Byte 10	Filtering Level (CH 7)				Filtering Level (CH 6)			

Data description:

16Bit Data Format: Big-endian and little-endian format of data upload

0: A_B

1: B_A

Temperature Unit: (Default: 0)

0: Degrees Celsius°C

1: Fahrenheit°F

2: Kelvin (K-)

CJC Model(CH 0-7): cold junction compensation mode (Default: 0)

0: Internal reference junction

1: Fixed reference temperature. 0°C

TC Input Type(CH 0-7): Sensor type of the channel (Default : 0: N/A)

0: N/A

1: J type

2: K type

3: E type

4: T type

5: S type

6: R type

7: B type

8: N type

Filtering Level Ch (0-7): Filter Level (Default: 4)

0: Level 0

1: Level 1

2: Level 2

3: Level 3

4: Level 4

5: Level 5

6: Level 6

7: Level 7

8: Level 8

9: Level 9

10: Level 10

11: Level 11

12: Level 12

 **WARNING**

UNEXPECTED EQUIPMENT OPERATION

The filtering parameters could be adjusted according to the field conditions. If the parameter settings are inappropriate, the signal will be lost.

Failure to follow instructions specified by the manufacturer may result in serious consequences such as death, personal injury, or damage to equipment since the protection provided by the equipment may be impaired.

 **AVERTISSEMENT**

FONCTIONNEMENT INATTENDU DE L'EQUIPEMENT

Les paramètres de filtrage peuvent être ajustés en fonction des conditions du site. Si les paramètres ne sont pas réglés correctement, la perte de signal se produira.

Le fait de ne pas suivre les instructions peut entraîner une défaillance de la protection fournie par l'équipement, ce qui peut entraîner des conséquences graves, comme des blessures ou des dommages à l'équipement.

A Dimension drawing

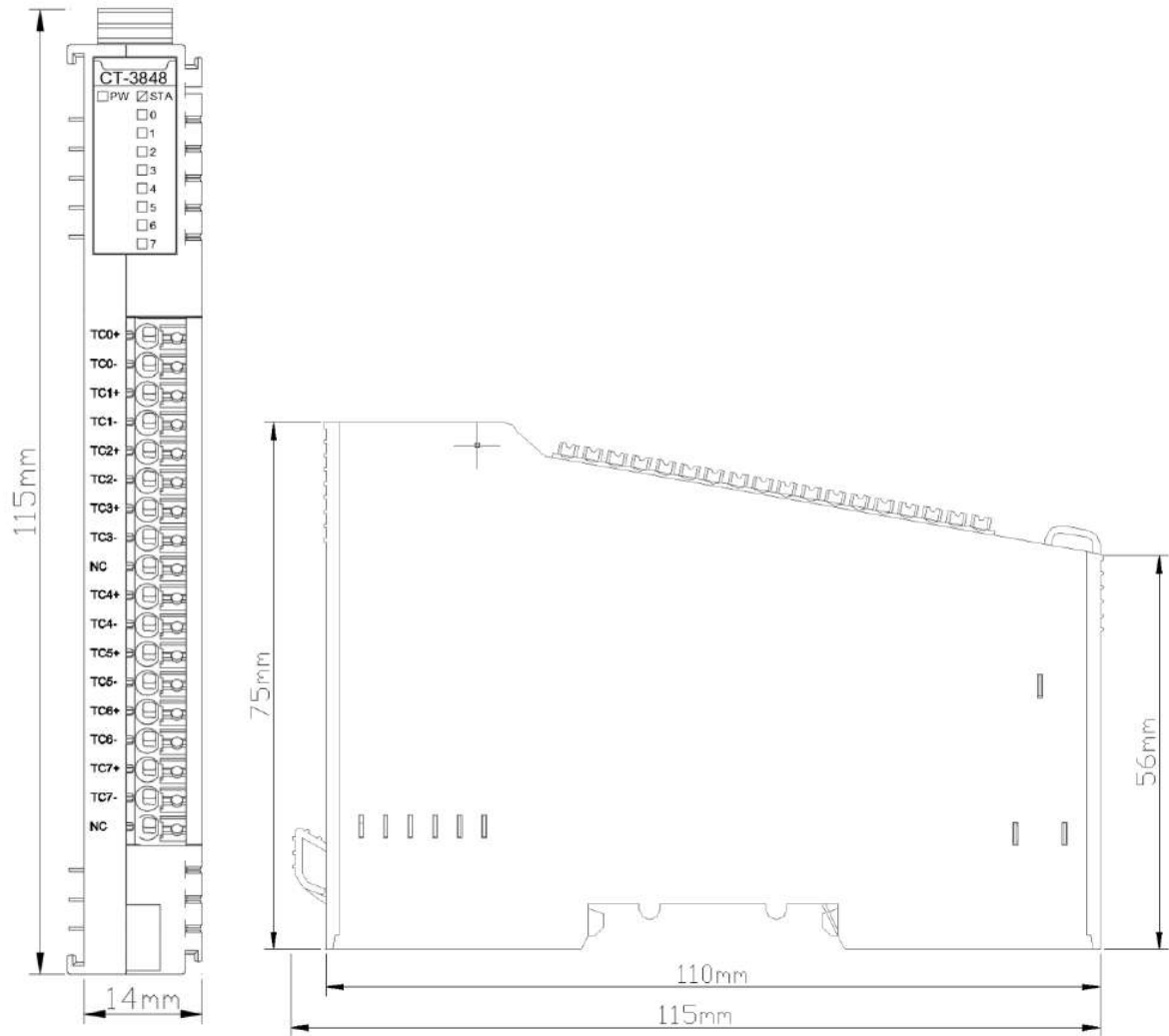

CT-4154 4 channels Voltage Output
0~5VDC/0~10VDC/±5VDC/±10VDC,16 bits

1 Module features

- ◆ The module supports 4 channels voltage signal output
- ◆ Output range: 0~5VDC, 0~10VDC, ±5VDC, ±10VDC, 16 bits
- ◆ The module carries with 4 analog output LED indicators
- ◆ Module output signal is single - ended common - grounded output

2 Technical Parameters

General Parameters	
Power	Max.500mA@5.0Vdc
Isolation	I/O to internal bus: magnetic isolation (3KVrms)
Field Power	Not used
Wiring	Max.: AWG 18
Mounting Type	35mmDIN-Rail
Size	115*14*75mm
Weight	65g
Environment Specification	
Operating Temperature of Horizontal Installation	-35°C~70°C
Operating Temperature of Vertical Installation	-35°C~60°C
Relative Humidity	< 95%RH (No Condensation)
Storage Temperature	-40°C~85°C
Storage Humidity	< 95%RH (No Condensation)
Manufacturing Test Temperature	-40°C~75°C
Ingress Protection Rating	IP20
Output Parameter	
Channel Number	4 Channels voltage output
LED Indicator	4 Channels voltage output indicator
Output Voltage Range	0~5VDC, 0~10VDC, ±5VDC, ±10VDC
Load Resistance	>5kΩ
Resolution	16 bits
Acquisition Accuracy	±0.1% (Full Scale) @25°C ±0.3(Full Scale) @-40~85°C
Conversion Time	1 ms / all channels
Diagnose	Overtemperature/overcurrent status monitoring
Protection Current	20mA.
Common Port	Common grounded output

WARNING

UNEXPECTED EQUIPMENT OPERATION

Do not exceed any of the ratings specified in the environmental and electrical characteristics table.

Failure to follow instructions specified by the manufacturer may result in serious consequences such as death, personal injury, or damage to equipment since the protection provided by the equipment may be impaired.

 **AVERTISSEMENT**

FONCTIONNEMENT INATTENDU DE L'EQUIPEMENT

Ne dépassez aucune évaluation spécifiée dans le tableau de caractéristiques environnementales et électriques..

Le fait de ne pas suivre les instructions peut entraîner une défaillance de la protection fournie par l'équipement, ce qui peut entraîner des conséquences graves, comme des blessures ou des dommages à l'équipement.

3 Hardware Interface

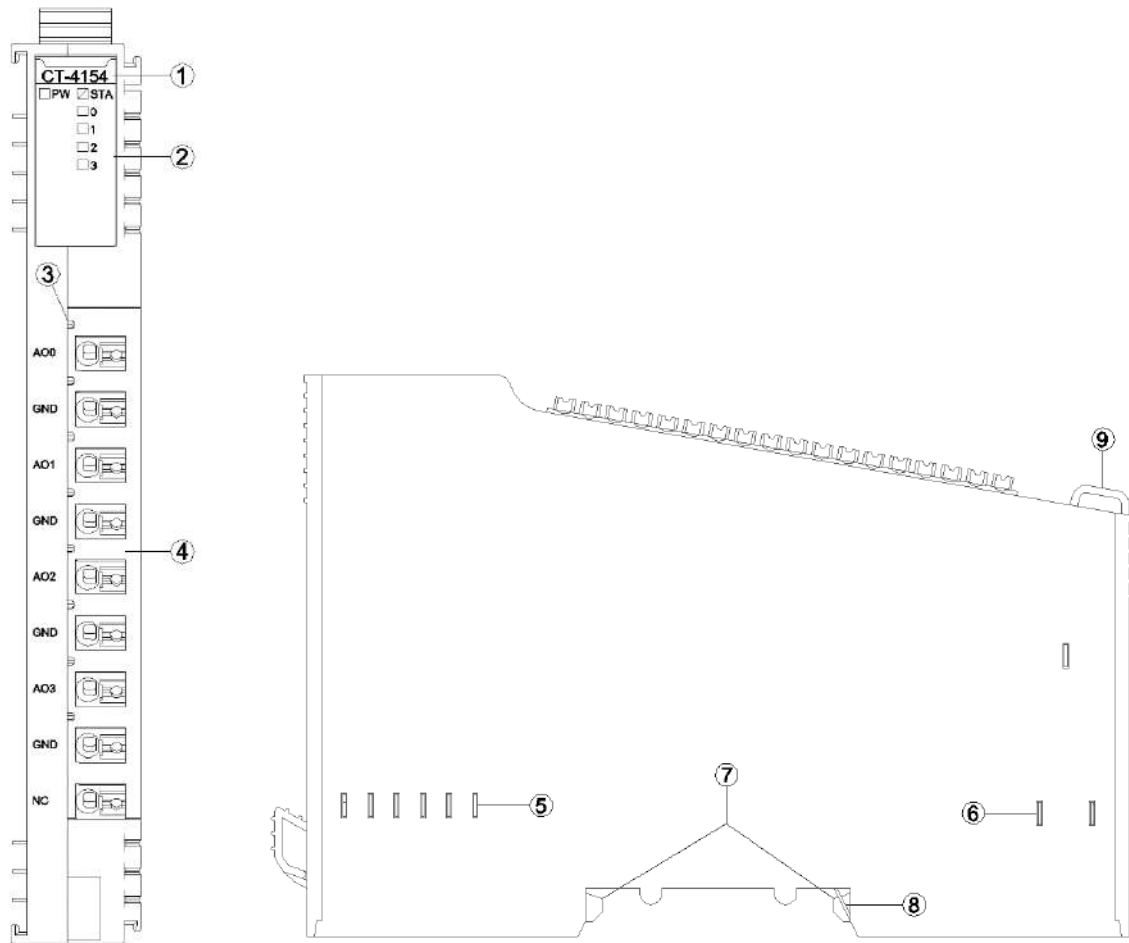

- ① Module Type
- ② State indicator
- ③ N/A
- ④ Wiring Terminal and identification
- ⑤ Internal Bus
- ⑥ Field Power
- ⑦ Buckle
- ⑧ Grounding Spring Sheet
- ⑨ Fixed Wiring Harness

3.1 LED indicator definition

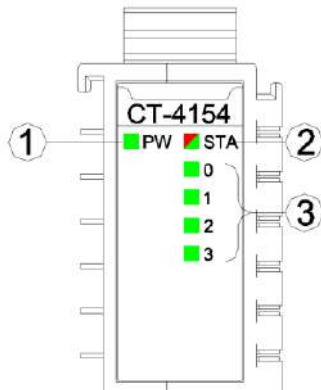

- ① Power LED indicator (green)
- ② Module State LED indicator (red/green)
- ③ Output channel LED indicator (green)

PW POWER STATE (GREEN)	Definition
ON	Internal bus Power Normal
OFF	Internal bus Power Failure
STA MODULE STATE (RED/GREEN)	Definition
Green slow flash (2.5Hz)	Module internal bus is not started
Red slow flash (2.5Hz)	Module internal bus offline
ON (GREEN)	Operation normal
Flash(2.5Hz) (RED/GREEN)	Upgrading mode
Flash(10Hz) (RED/GREEN)	Firmware Update
Double Flash (RED)	Module Exception has been soft-restarted
0-3 Channel Indicator	Definition
ON	The output value is not 0
OFF	The output value is 0

⚠️ WARNING

UNEXPECTED EQUIPMENT OPERATION

By viewing the PW indicator, could determine the power supply status of a module. If the PW is steady green, the power supply is normal. Otherwise, the module cannot work properly.

When the module is initially powered on, there will be 3S for the backplane bus connection. After the backplane bus is initialized, STA is in the green steady state. If STA is in the green blinking state, it indicates that the backplane bus has not been initialized, and it needs to be powered off

and restarted for re-initialization.

STA abnormal working state occurs during the normal operation of the module, please check the firmware version information of all modules, and consult ODOT technical support for details.

If a module is upgraded, check that all modules are in the normal state after the upgrade. Otherwise, an exception may occur.

Failure to follow instructions specified by the manufacturer may result in serious consequences such as death, personal injury, or damage to equipment since the protection provided by the equipment may be impaired.

AVERTISSEMENT

FONCTIONNEMENT INATTENDU DE L'EQUIPEMENT

En regardant l'état de l'indicateur de PW, jugez l'état d'alimentation du module. Le feu vert PW reste allumé et l'alimentation est normale. Autrement, le module ne fonctionnera pas correctement.

Lorsque le module est alimenté initialement, il y aura 3S pour la connexion de bus de backboard. STA est un état vert permanent après l'initialisation du bus de backboard. Si STA est en état de clignotement vert, cela signifie que l'initialisation du bus de backboard n'est pas passée et doit être redémarrée hors tension et réinitialisée.

L'état de fonctionnement anormal de STA se produit pendant le fonctionnement normal du module, veuillez vérifier les informations de version du firmware de tous les modules, et consulter le support technique ODOT pour plus de détails.

Si le module a une opération de mise à niveau, après l'achèvement de la mise à niveau, le besoin de vérifier que tous les modules sont dans l'état normal avant de courir, sinon il conduira à une exception.

Le fait de ne pas suivre les instructions peut entraîner une défaillance de la protection fournie par l'équipement, ce qui peut entraîner des conséquences graves, comme des blessures ou des dommages à l'équipement.

3.2 Terminal definition

Terminal Number	Definition	Description
1	AO0	Signal Output CH0
2	GND	
3	AO1	Signal Output CH1
4	GND	
5	AO2	Signal Output CH2
6	GND	
7	AO3	Signal Output CH3
8	GND	
NC	NC	Not Connected

! WARNING

UNEXPECTED EQUIPMENT OPERATION

Calculate the maximum field power current consumption of a single module based on the actual field load. If the total field power current consumption of all I/O modules exceeds the power supply capacity of the field power supply, you must add an extra power expansion module. Otherwise, an output channel exception may occur.

Failure to follow instructions specified by the manufacturer may result in serious consequences such as death, personal injury, or damage to equipment since the protection provided by the equipment may be impaired.

! AVERTISSEMENT

FONCTIONNEMENT INATTENDU DE L'EQUIPEMENT

Calculez la consommation maximale de courant de champ d'un seul module en fonction de la charge de champ réelle. Si la consommation totale de courant de champ de tous les modules d'E/S dépasse la capacité d'alimentation de l'alimentation de champ, vous devez ajouter un module d'extension de puissance supplémentaire. Dans le cas contraire, une exception de canal de sortie peut se produire.

Le fait de ne pas suivre les instructions peut entraîner une défaillance de la protection fournie par l'équipement, ce qui peut entraîner des conséquences graves, comme des blessures ou des dommages à l'équipement.

When connecting a cold-pressed terminal, the terminal must be terminated and checked in strict accordance with the corresponding termination specifications or requirements, and connect the cold-pressed terminal according to the corresponding node serial number. The conductor should use copper conductor and the conductor core should be larger than 0.2mm^2 and smaller than 1mm^2 (AWG18~AWG24). Cold-pressed terminal parameters are as follows:

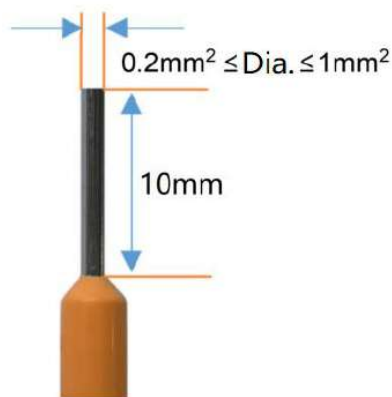

WARNING

UNEXPECTED EQUIPMENT OPERATION

Strip the length of the conductor insulation layer is greater than 10mm to ensure reliable signal connection.

The wire needs to use copper wire and the wire core is greater than or equal to 0.2mm² and less than or equal to 1mm² to ensure reliable signal connection.

When connecting a cold-press terminal, connect the cold-press terminal strictly in accordance with the corresponding termination specifications or requirements, and connect the cold-press terminal according to the corresponding node serial number.

Do not power on cold-press terminals until they are properly connected or fully locked.

Failure to follow instructions specified by the manufacturer may result in serious consequences such as death, personal injury, or damage to equipment since the protection provided by the equipment may be impaired.

AVERTISSEMENT

FONCTIONNEMENT INATTENDU DE L'EQUIPEMENT

Dépouillez la longueur de la couche isolante du fil plus de 10mm pour assurer la connexion fiable du signal.

Le conducteur doit utiliser le fil de cuivre et le noyau de fil est supérieur ou égal à 0,2 mm², inférieur ou égal à 1mm², afin d'assurer la connexion fiable du signal.

Lorsque les terminaux de presse à froid sont terminés, ils doivent être terminés et visualisés en stricte conformité avec les spécifications ou les exigences correspondantes et terminés selon le numéro de série de noeud correspondant.

Il est interdit d'activer les bornes à froid avant qu'elles ne soient correctement articulées ou complètement verrouillées.

Le fait de ne pas suivre les instructions peut entraîner une défaillance de la protection fournie par l'équipement, ce qui peut entraîner des conséquences graves, comme des blessures ou des dommages à l'équipement.

DANGER

FIRE DANGER

Use the correct wiring rules only for the maximum current capacity of the I/O channel and power supply.

Failure to follow instructions specified by the manufacturer may result in serious consequences such as death, personal injury, or damage to equipment since the protection provided by the equipment may be impaired.

 **WARNING**

UNEXPECTED EQUIPMENT OPERATION

Do not exceed any of the ratings specified in the environmental and electrical characteristics table.

Failure to follow instructions specified by the manufacturer may result in serious consequences such as death, personal injury, or damage to equipment since the protection provided by the equipment may be impaired.

 **AVERTISSEMENT**

FONCTIONNEMENT INATTENDU DE L'EQUIPEMENT

Ne dépassez aucune évaluation spécifiée dans le tableau de caractéristiques environnementales et électriques..

Le fait de ne pas suivre les instructions peut entraîner une défaillance de la protection fournie par l'équipement, ce qui peut entraîner des conséquences graves, comme des blessures ou des dommages à l'équipement.

4 Wiring

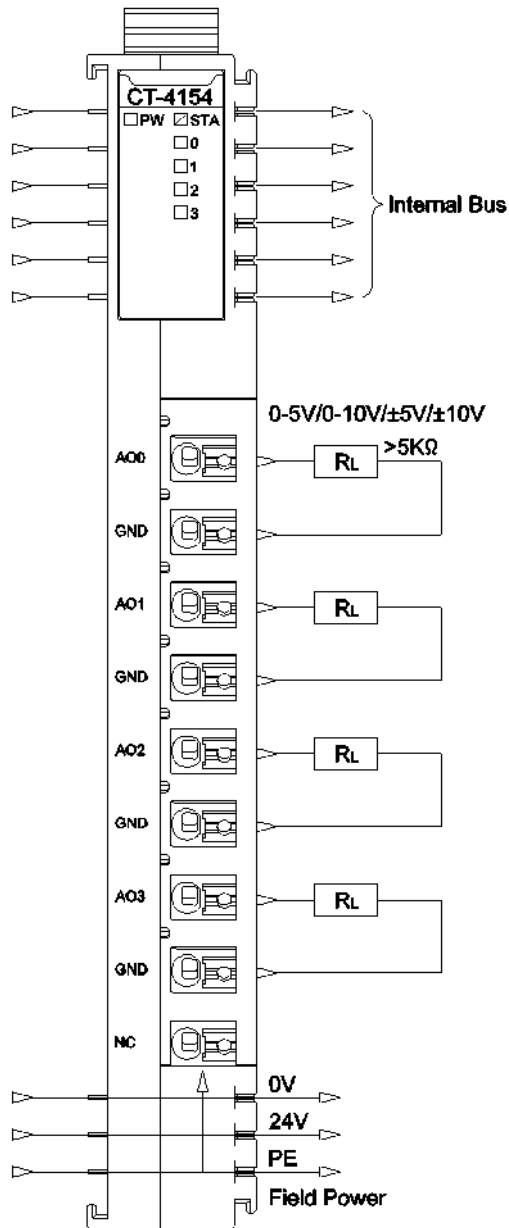

WARNING

UNEXPECTED EQUIPMENT OPERATION

Do not link wires to unused terminals and/or terminals marked "NO CONNECTION (NC)".

Failure to follow instructions specified by the manufacturer may result in serious consequences such as death, personal injury, or damage to equipment since the protection provided by the equipment may be impaired.

AVERTISSEMENT

FONCTIONNEMENT INATTENDU DE L'EQUIPEMENT

Ne liez pas les fils aux bornes inutilisées et/ou aux bornes marquées «NO CONNECTION (NC)».

Le fait de ne pas suivre les instructions peut entraîner une défaillance de la protection fournie par l'équipement, ce qui peut entraîner des conséquences graves, comme des blessures ou des dommages à l'équipement.

NOTICE

EQUIPMENT INOPERABLE

Do not crimp the spring terminal with more than the maximum pressure specified for the terminal. Otherwise, the resilience of the spring terminal may be damaged and the terminal rebound may be affected.

Do not press the spring terminal with a sharp tool when removing cable from the channel. Otherwise, the spring terminal will be damaged.

Failure to follow these instructions may result in equipment damage.

5 Process data definition

Input Data								
Bit No	Bit 7	Bit 6	Bit 5	Bit 4	Bit 3	Bit 2	Bit 1	Bit 0
Byte 0	Reserved							
Output Data								
Bit No	Bit 7	Bit 6	Bit 5	Bit 4	Bit 3	Bit 2	Bit 1	Bit 0
Byte 0	Analog Output Data (CH 0)							
Byte 1								
Byte 2	Analog Output Data (CH 1)							
Byte 3								
Byte 4	Analog Output Data (CH 2)							
Byte 5								
Byte 6	Analog Output Data (CH 3)							
Byte 7								

5.1 Process data definition (standard mode)

Data description:

Analog Output Data (CH0-3): voltage output value

Unipolarity 0-5V/0-10V output value

Analog Output Data (CT-4154) (0-5V/0-10V)			
Voltage (0-5V)	Voltage (0-10V)	Decimal	Hex
5	10	27648	0x6C00
.	.	.	.
.	.	.	.
2.5	5	13824	0x3600
.	.	.	.
.	.	.	.
0	0	0	0x0000

Bipolar $\pm 5V/\pm 10V$ Output value

Analog Output Data (CT-4154) ($\pm 5V/\pm 10V$)			
Voltage ($\pm 5V$)	Voltage ($\pm 10V$)	Decimal	Hex
5	10	27648	0x6C00
.	.	.	.
.	.	.	.
2.5	5	13824	0x3600
.	.	.	.
.	.	.	.
0	0	0	0x0000
.	.	.	.
.	.	.	.
-2.5	-5	-13824	0xCA00
.	.	.	.
.	.	.	.
-5	-10	-27648	0x9400

5.2 Process data definition (special mode)

Data description:

Analog Output Data (CH0-3): voltage output value

Unipolarity 0-5V/0-10V output value

Analog Output Data (CT-4154) (0-5V/0-10V)			
Voltage (0-5V)	Voltage (0-10V)	Decimal	Hex
5	10	65535	0xFFFF
.	.	.	.
.	.	.	.
2.5	5	32767	0x7FFF
.	.	.	.
.	.	.	.
0	0	0	0x0000

Bipolar $\pm 5V/\pm 10V$ Output value

Analog Output Data (CT-4154) ($\pm 5V/\pm 10V$)			
Voltage ($\pm 5V$)	Voltage ($\pm 10V$)	Decimal	Hex
5	10	32767	0x7FFF
.	.	.	.
.	.	.	.
2.5	5	16383	0x3FFF
.	.	.	.
.	.	.	.
0	0	0	0x0000
.	.	.	.
.	.	.	.
-2.5	-5	-16384	0xC000
.	.	.	.
.	.	.	.
-5	-10	-32768	0x8000

6 Configuration parameters definition

Configuration parameter								
Bit No	Bit 7	Bit 6	Bit 5	Bit 4	Bit 3	Bit 2	Bit 1	Bit 0
Byte 0	Reserved						Range_ Mode	16Bit Data Format
Byte 1	Voltage Type(CH 1)				Voltage Type(CH 0)			
Byte 2	Voltage Type(CH 3)				Voltage Type(CH 2)			

Data description:

16Bit Data Format: 16 bits data byte transmission sequence (default value: A_B)

A_B: Big-endian format transmission

B_A: Little-endian format transmission

Range_Mode: Process data mode (default: standard mode)

Standard mode: same with Siemens process data definition

Special mode: max range of the hardware

Voltage Type(CH 0-3): Output voltage type (default value: 0~10Vdc)

Disable: Output disabled

0~5Vdc: 0~5V Direct-current output

0~10Vdc: 0~10V Direct-current output

-5~5Vdc: -5~5V Direct-current output

-10~10Vdc: -10~10V Direct-current output

A Dimension drawing

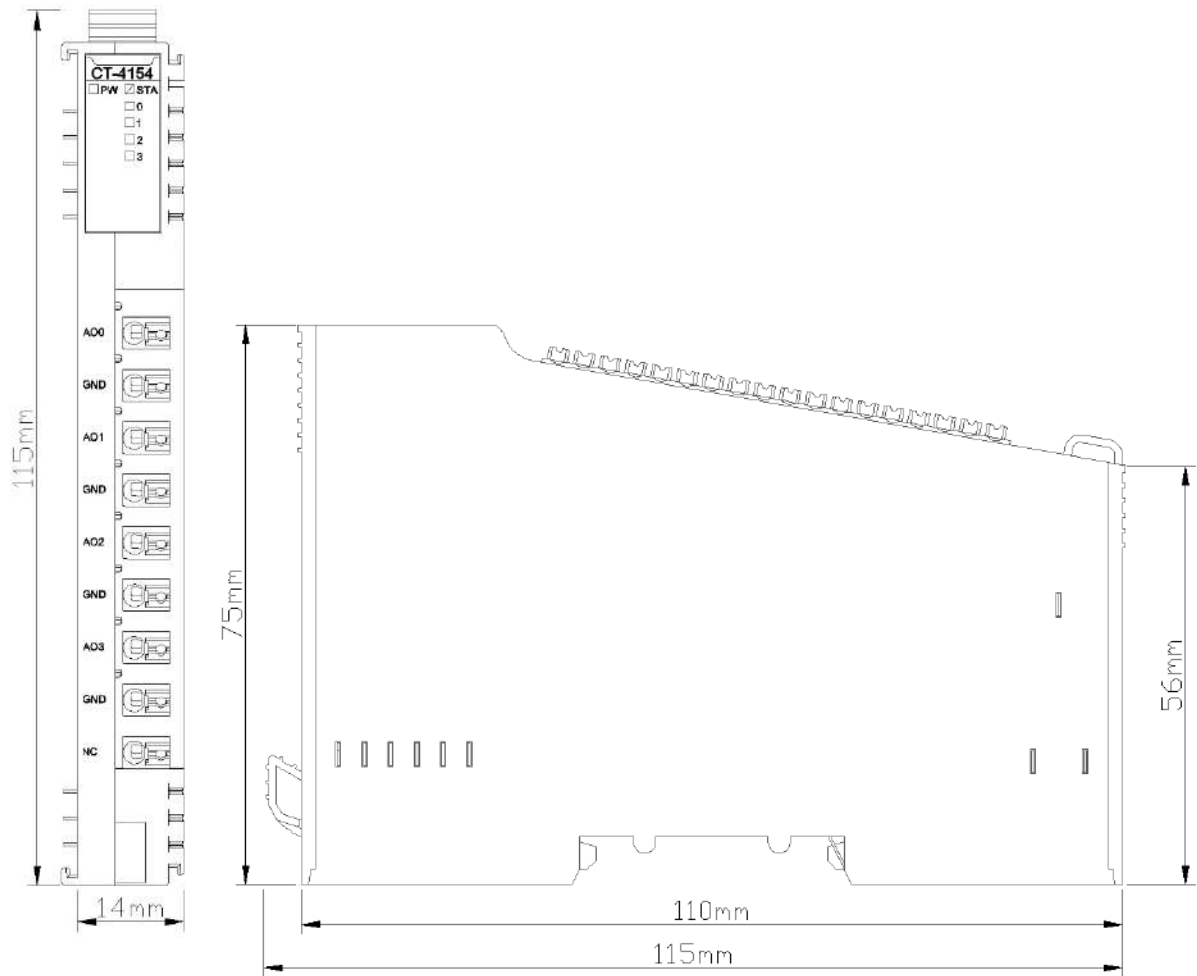

CT-4158 8 channels Voltage Output
0~5VDC/0~10VDC/±5VDC/±10VDC,16bits

1 Module features

- ◆The module supports 8 channels voltage signal output
- ◆Output range: 0~5VDC, 0~10VDC, ±5VDC, ±10VDC, 16 bits
- ◆The module carries with 8 analog output LED indicators
- ◆Module output signal is single - ended common - grounded output

2 Technical Parameters

General Parameters	
Power	Max.500mA@5.0Vdc
Isolation	I/O to internal bus: magnetic isolation (3KVrms)
Field Power	Not used
Wiring	Max.: AWG 18
Mounting Type	35mmDIN-Rail
Size	115*14*75mm
Weight	65g
Vibration Resistance	Comply with IEC 61131-2 and EC 60068-2-6
Impact resistance	Comply with IEC 61131-2 and IEC 60068-2-27
EMC Performance	Comply with IEC 61131-2 and IEC 61000-4
Environment Specification	
Operating Temperature of Horizontal Installation	-35°C~70°C
Operating Temperature of Vertical Installation	-35°C~60°C
Relative Humidity	< 95%RH (No Condensation)
Storage Temperature	-40°C~85°C
Storage Humidity	< 95%RH (No Condensation)
Manufacturing Test Temperature	-40°C~75°C
Ingress Protection Rating	IP20
Output Parameter	
Channel Number	8Channels voltage output
LED Indicator	8 Channels voltage output indicator
Output Voltage Range	0~5VDC, 0~10VDC, ±5VDC, ±10VDC
Load Resistance	>5kΩ
Resolution	16 bits
Acquisition Accuracy	±0.1% (Full Scale) @25°C ±0.3(Full Scale) @-40~85°C
Conversion Time	1 ms / all channels
Diagnose	Overtemperature/overcurrent status monitoring
Protection Current	20mA.
Common Port	Common grounded output

WARNING

UNEXPECTED EQUIPMENT OPERATION

Do not exceed any of the ratings specified in the environmental and electrical characteristics table.

Failure to follow instructions specified by the manufacturer may result in serious

consequences such as death, personal injury, or damage to equipment since the protection provided by the equipment may be impaired.

 **AVERTISSEMENT**

FONCTIONNEMENT INATTENDU DE L'EQUIPEMENT

Ne dépassez aucune évaluation spécifiée dans le tableau de caractéristiques environnementales et électriques..

Le fait de ne pas suivre les instructions peut entraîner une défaillance de la protection fournie par l'équipement, ce qui peut entraîner des conséquences graves, comme des blessures ou des dommages à l'équipement.

3 Hardware Interface

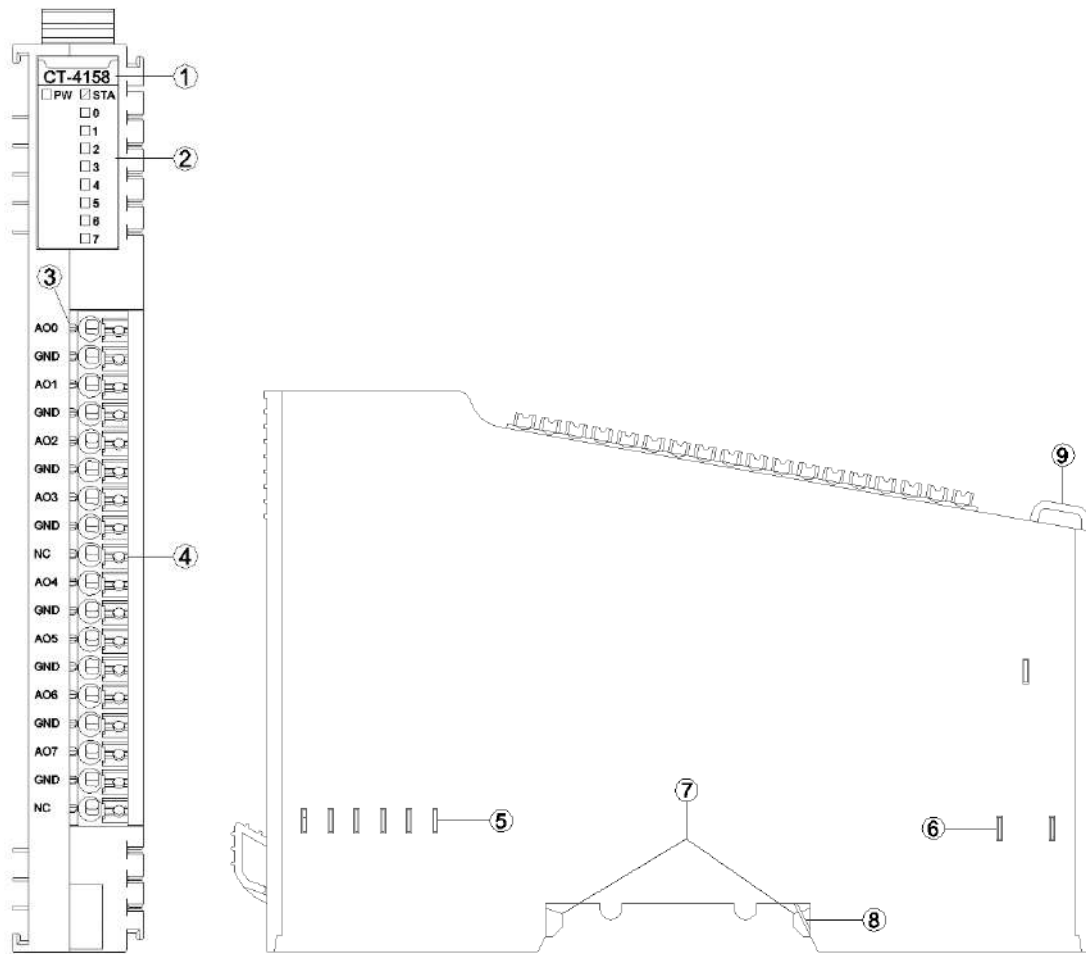

- ① Module Type
- ② State indicator
- ③ N/A
- ④ Wiring Terminal and identification
- ⑤ Internal Bus
- ⑥ Field Power
- ⑦ Buckle
- ⑧ Grounding Spring Sheet
- ⑨ Fixed Wiring Harness

3.1 LED indicator definition

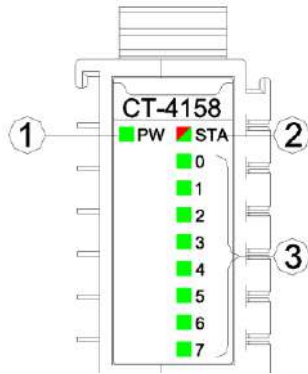

- ① Power LED indicator (green)
- ② Module State LED indicator (red/green)
- ③ Output channel LED indicator (green)

PW POWER STATE (GREEN)	Definition
ON	Internal bus Power Normal
OFF	Internal bus Power Failure
STA MODULE STATE (RED/GREEN)	Definition
Green slow flash (2.5Hz)	Module internal bus is not started
Red slow flash (2.5Hz)	Module internal bus offline
ON (GREEN)	Operation normal
Flash(2.5Hz) (RED/GREEN)	Upgrading mode
Flash(10Hz) (RED/GREEN)	Firmware Update
Double Flash (RED)	Module Exception has been soft-restarted
0-7 Channel Indicator	Definition
ON	The output value is not 0
OFF	The output value is 0

! WARNING

UNEXPECTED EQUIPMENT OPERATION

By viewing the PW indicator, could determine the power supply status of a module. If the PW is steady green, the power supply is normal. Otherwise, the module cannot work properly.

When the module is initially powered on, there will be 3S for the backplane bus connection. After the backplane bus is initialized, STA is in the green steady state. If STA is in the green blinking state, it indicates that the backplane bus has not been initialized, and it needs to be powered off and restarted for re-initialization.

STA abnormal working state occurs during the normal operation of the module, please check the firmware version information of all modules, and consult ODOT technical support for details.

If a module is upgraded, check that all modules are in the normal state after the upgrade. Otherwise, an exception may occur.

Failure to follow instructions specified by the manufacturer may result in serious consequences such as death, personal injury, or damage to equipment since the protection provided by the equipment may be impaired.

AVERTISSEMENT

FONCTIONNEMENT INATTENDU DE L'EQUIPEMENT

En regardant l'état de l'indicateur de PW, jugez l'état d'alimentation du module. Le feu vert PW reste allumé et l'alimentation est normale. Autrement, le module ne fonctionnera pas correctement.

Lorsque le module est alimenté initialement, il y aura 3S pour la connexion de bus de backboard. STA est un état vert permanent après l'initialisation du bus de backboard. Si STA est en état de clignotement vert, cela signifie que l'initialisation du bus de backboard n'est pas passée et doit être redémarrée hors tension et réinitialisée.

L'état de fonctionnement anormal de STA se produit pendant le fonctionnement normal du module, veuillez vérifier les informations de version du firmware de tous les modules, et consulter le support technique ODOT pour plus de détails.

Si le module a une opération de mise à niveau, après l'achèvement de la mise à niveau, le besoin de vérifier que tous les modules sont dans l'état normal avant de courir, sinon il conduira à une exception.

Le fait de ne pas suivre les instructions peut entraîner une défaillance de la protection fournie par l'équipement, ce qui peut entraîner des conséquences graves, comme des blessures ou des dommages à l'équipement.

3.2 Terminal definition

Terminal Number	Definition	Description
1	AO0	Signal Output CH0
2	GND	
3	AO1	Signal Output CH1
4	GND	
5	AO2	Signal Output CH2
6	GND	
7	AO3	Signal Output CH3
8	GND	
9	NC	Not Connected
10	AO4	Signal Output CH4
11	GND	
12	AO5	Signal Output CH5
13	GND	
14	AO6	Signal Output CH6
15	GND	
16	AO7	Signal Output CH7
17	GND	
18	NC	Not Connected

WARNING

UNEXPECTED EQUIPMENT OPERATION

Calculate the maximum field power current consumption of a single module based on the actual field load. If the total field power current consumption of all I/O modules exceeds the power supply capacity of the field power supply, you must add an extra power expansion module. Otherwise, an output channel exception may occur.

Failure to follow instructions specified by the manufacturer may result in serious consequences such as death, personal injury, or damage to equipment since the protection provided by the equipment may be impaired.

AVERTISSEMENT

FONCTIONNEMENT INATTENDU DE L'EQUIPEMENT

Calculez la consommation maximale de courant de champ d'un seul module en fonction de la charge de champ réelle. Si la consommation totale de courant de champ de tous les modules d'E/S dépasse la capacité d'alimentation de l'alimentation de champ, vous devez ajouter un module d'extension de puissance supplémentaire. Dans le cas contraire, une exception de canal de sortie peut se produire.

Le fait de ne pas suivre les instructions peut entraîner une défaillance de la protection fournie par l'équipement, ce qui peut entraîner des conséquences graves, comme des blessures ou des dommages à l'équipement.

When connecting a cold-pressed terminal, the terminal must be terminated and checked in strict accordance with the corresponding termination specifications or requirements, and connect the cold-pressed terminal according to the corresponding node serial number. The conductor should use copper conductor and the conductor core should be larger than 0.2mm^2 and smaller than 1mm^2 (AWG18~AWG24). Cold-pressed terminal parameters are as follows:

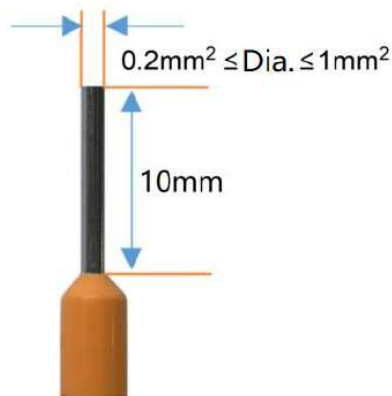

!WARNING

UNEXPECTED EQUIPMENT OPERATION

Strip the length of the conductor insulation layer is greater than 10mm to ensure reliable signal connection.

The wire needs to use copper wire and the wire core is greater than or equal to 0.2mm^2 and less than or equal to 1mm^2 to ensure reliable signal connection.

When connecting a cold-press terminal, connect the cold-press terminal strictly in accordance with the corresponding termination specifications or requirements, and connect the cold-press terminal according to the corresponding node serial number.

Do not power on cold-press terminals until they are properly connected or fully locked.

Failure to follow instructions specified by the manufacturer may result in serious consequences such as death, personal injury, or damage to equipment since the protection provided by the equipment may be impaired.

!AVERTISSEMENT

FONCTIONNEMENT INATTENDU DE L'EQUIPEMENT

Dépouillez la longueur de la couche isolante du fil plus de 10mm pour assurer la connexion fiable du signal.

Le conducteur doit utiliser le fil de cuivre et le noyau de fil est supérieur ou égal à $0,2\text{ mm}^2$, inférieur ou égal à 1mm^2 , afin d'assurer la connexion fiable du signal.

Lorsque les terminaux de presse à froid sont terminés, ils doivent être terminés et visualisés en stricte conformité avec les spécifications ou les exigences correspondantes et terminés selon le numéro de série de noeud correspondant.

Il est interdit d'activer les bornes à froid avant qu'elles ne soient correctement articulées ou complètement verrouillées.

Le fait de ne pas suivre les instructions peut entraîner une défaillance de la protection fournie par l'équipement, ce qui peut entraîner des conséquences graves, comme des blessures ou des dommages à l'équipement.

DANGER

FIRE DANGER

Use the correct wiring rules only for the maximum current capacity of the I/O channel and power supply.

Failure to follow instructions specified by the manufacturer may result in serious consequences such as death, personal injury, or damage to equipment since the protection provided by the equipment may be impaired.

WARNING

UNEXPECTED EQUIPMENT OPERATION

Do not exceed any of the ratings specified in the environmental and electrical characteristics table.

Failure to follow instructions specified by the manufacturer may result in serious consequences such as death, personal injury, or damage to equipment since the protection provided by the equipment may be impaired.

AVERTISSEMENT

FONCTIONNEMENT INATTENDU DE L'EQUIPEMENT

Ne dépassez aucune évaluation spécifiée dans le tableau de caractéristiques environnementales et électriques..

Le fait de ne pas suivre les instructions peut entraîner une défaillance de la protection fournie par l'équipement, ce qui peut entraîner des conséquences graves, comme des blessures ou des dommages à l'équipement.

4 Wiring

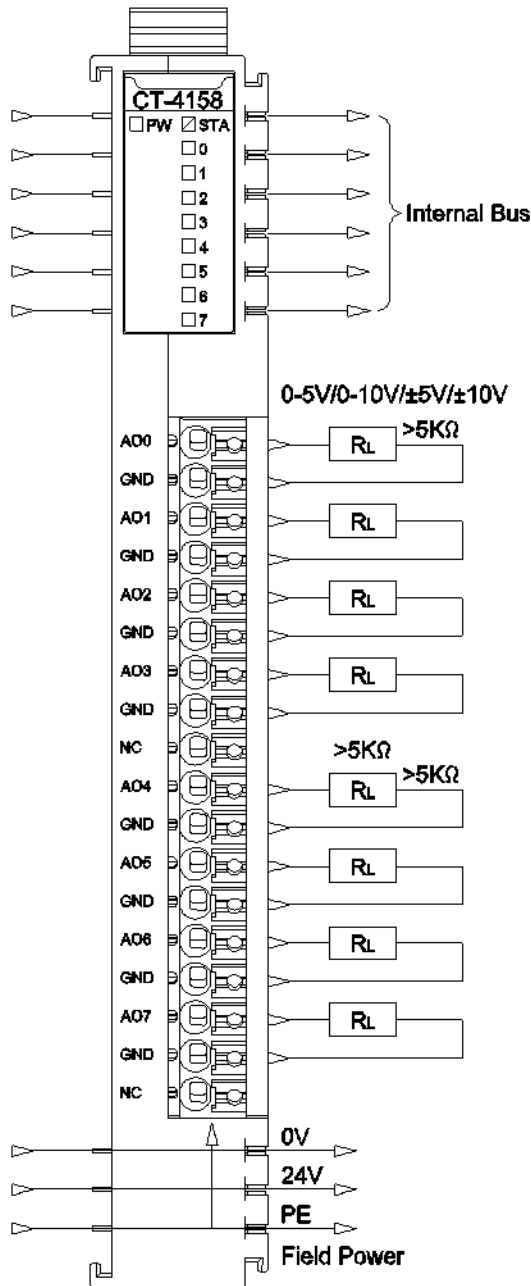

! WARNING

UNEXPECTED EQUIPMENT OPERATION

Do not link wires to unused terminals and/or terminals marked "NO CONNECTION (NC)".

Failure to follow instructions specified by the manufacturer may result in serious consequences such as death, personal injury, or damage to equipment since the protection provided by the equipment may be impaired.

AVERTISSEMENT

FONCTIONNEMENT INATTENDU DE L'EQUIPEMENT

Ne liez pas les fils aux bornes inutilisées et/ou aux bornes marquées «NO CONNECTION (NC)».

Le fait de ne pas suivre les instructions peut entraîner une défaillance de la protection fournie par l'équipement, ce qui peut entraîner des conséquences graves, comme des blessures ou des dommages à l'équipement.

NOTICE

EQUIPMENT INOPERABLE

Do not crimp the spring terminal with more than the maximum pressure specified for the terminal. Otherwise, the resilience of the spring terminal may be damaged and the terminal rebound may be affected.

Do not press the spring terminal with a sharp tool when removing cable from the channel. Otherwise, the spring terminal will be damaged.

Failure to follow these instructions may result in equipment damage.

5 Process data definition

Input Data								
Bit No	Bit 7	Bit 6	Bit 5	Bit 4	Bit 3	Bit 2	Bit 1	Bit 0
Byte 0	Reserved							Overtemperature
Output Data								
Bit No	Bit 7	Bit 6	Bit 5	Bit 4	Bit 3	Bit 2	Bit 1	Bit 0
Byte 0	Analog Output Data (CH 0)							
Byte 1								
Byte 2	Analog Output Data (CH 1)							
Byte 3								
Byte 4	Analog Output Data (CH 2)							
Byte 5								
Byte 6	Analog Output Data (CH 3)							
Byte 7								
Byte 8	Analog Output Data (CH 4)							
Byte 9								
Byte 10	Analog Output Data (CH 5)							
Byte 11								
Byte 12	Analog Output Data (CH 6)							
Byte 13								
Byte 14	Analog Output Data (CH 7)							
Byte 15								

Data description:

Analog Output Data (CH0-7): voltage output value

Unipolarity 0-5V/0-10V output value

5.1 Process data definition (standard mode)

Data description:

Analog Output Data (CH0-7): voltage output value

Unipolarity 0-5V/0-10V output value

Analog Output Data (CT-4158) (0-5V/0-10V)			
Voltage (0-5V)	Voltage (0-10V)	Decimal	Hex
5	10	27648	0x6C00
.	.	.	.
.	.	.	.
2.5	5	13824	0x3600
.	.	.	.
.	.	.	.
0	0	0	0x0000

Bipolar $\pm 5V/\pm 10V$ Output value

Analog Output Data (CT-4158) ($\pm 5V/\pm 10V$)			
Voltage ($\pm 5V$)	Voltage ($\pm 10V$)	Decimal	Hex
5	10	27648	0x6C00
.	.	.	.
.	.	.	.
2.5	5	13824	0x3600
.	.	.	.
.	.	.	.
0	0	0	0x0000
.	.	.	.
.	.	.	.
-2.5	-5	-13824	0xCA00
.	.	.	.
.	.	.	.
-5	-10	-27648	0x9400

5.2 Process data definition (special mode)

Data description:

Analog Output Data (CH0-7): voltage output value

Unipolarity 0-5V/0-10V output value

Analog Output Data (CT-4158) (0-5V/0-10V)			
Voltage (0-5V)	Voltage (0-10V)	Decimal	Hex
5	10	65535	0xFFFF
.	.	.	.
.	.	.	.
2.5	5	32767	0x7FFF
.	.	.	.
.	.	.	.
0	0	0	0x0000

Bipolar $\pm 5V/\pm 10V$ Output value

Analog Output Data (CT-4158) ($\pm 5V/\pm 10V$)			
Voltage ($\pm 5V$)	Voltage ($\pm 10V$)	Decimal	Hex
5	10	32767	0x7FFF
.	.	.	.
.	.	.	.
2.5	5	16383	0x3FFF
.	.	.	.
.	.	.	.
0	0	0	0x0000
.	.	.	.
.	.	.	.
-2.5	-5	-16384	0xC000
.	.	.	.
.	.	.	.
-5	-10	-32768	0x8000

6 Configuration parameters definition

Configuration parameter								
Bit No	Bit 7	Bit 6	Bit 5	Bit 4	Bit 3	Bit 2	Bit 1	Bit 0
Byte 0	Reserved						Range_ Mode	16Bit Data Format
Byte 1	Voltage Type(CH 1)				Voltage Type(CH 0)			
Byte 2	Voltage Type(CH 3)				Voltage Type(CH 2)			
Byte 3	Voltage Type(CH 5)				Voltage Type(CH 4)			
Byte 4	Voltage Type(CH 7)				Voltage Type(CH 6)			

Data description:

16Bit Data Format: 16 bits data byte transmission sequence (default value: A_B)

A_B: Big-endian format transmission

B_A: Little-endian format transmission

Range_Mode: Process data mode (default: standard mode)

Standard mode: same with Siemens process data definition

Special mode: max range of the hardware

Voltage Type(CH 0-7): Output voltage type (default value: 0~10Vdc)

Disable: Output disabled

0~5Vdc: 0~5V Direct-current output

0~10Vdc: 0~10V Direct-current output

-5~5Vdc: -5~5V Direct-current output

-10~10Vdc: -10~10V Direct-current output



WARNING

UNEXPECTED EQUIPMENT OPERATION

Adjust the output voltage type parameters according to the site conditions. If the parameters are improperly set, the output signal will be incorrect.

Failure to follow instructions specified by the manufacturer may result in serious consequences such as death, personal injury, or damage to equipment since the protection provided by the equipment may be impaired.

 **AVERTISSEMENT**

FONCTIONNEMENT INATTENDU DE L'EQUIPEMENT

Les paramètres de type de tension de sortie peuvent être ajustés en fonction des conditions du site. Si les paramètres ne sont pas réglés correctement, le signal de sortie sera erroné.

Le fait de ne pas suivre les instructions peut entraîner une défaillance de la protection fournie par l'équipement, ce qui peut entraîner des conséquences graves, comme des blessures ou des dommages à l'équipement.

A Dimension drawing

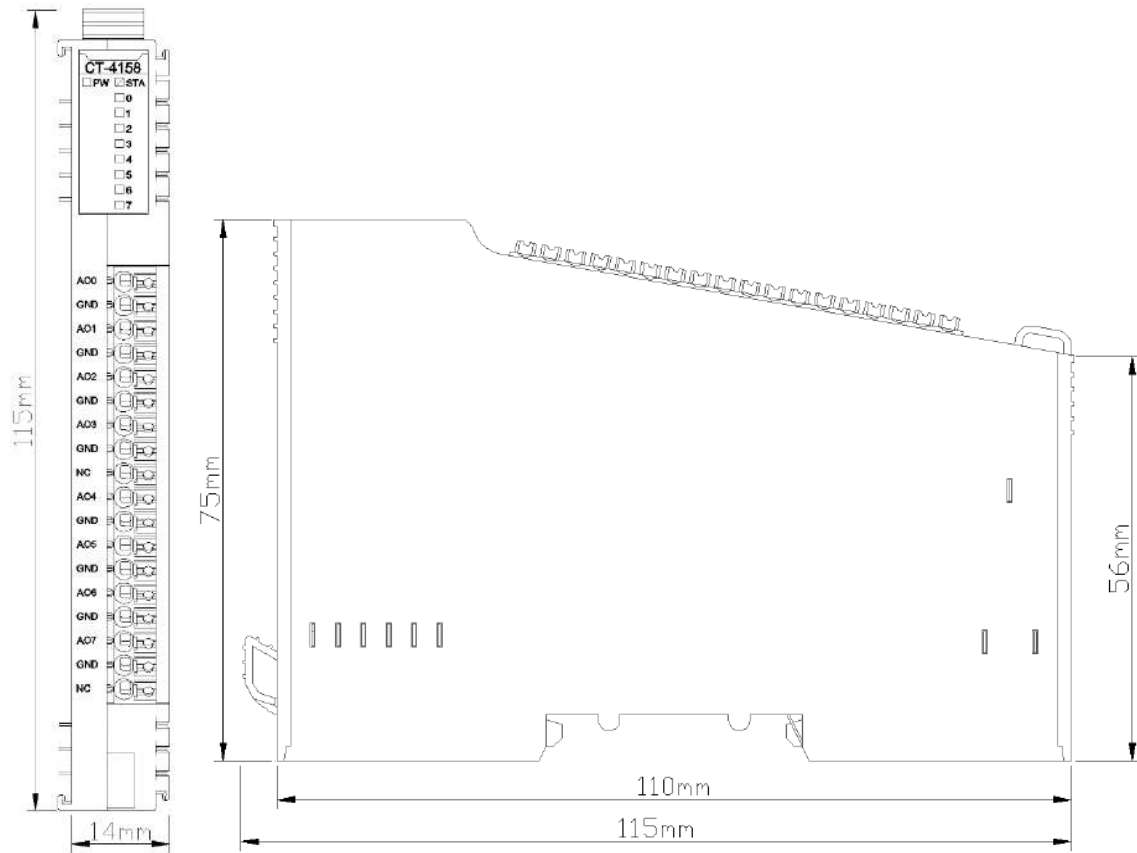

CT-4234 4 channels analog output /0&4-20mA/16-bit single-terminal

1 Module features

- ◆ 2 output ranges can be set(0-20mA, 4-20mA)
- ◆ The module internal bus and field output adopts magnetic insulation
- ◆ Single-terminal grounded together output mode

2 Technical parameters

General Parameters	
Power	Max.25mA@5.0Vdc
IO Bus Isolation	I/O to internal bus: magnetic isolation (2.5KVrms)
Wiring	Max.: AWG 18
Installation	35mm DIN-Rail
Size	115*14*75mm
Weight	65g
Vibration Resistance	Comply with IEC 61131-2 and EC 60068-2-6
Impact resistance	Comply with IEC 61131-2 and IEC 60068-2-27
EMC Performance	Comply with IEC 61131-2 and IEC 61000-4
Environmental Parameters	
Operating Temperature of Horizontal Installation	-35°C~70°C
Operating Temperature of Vertical Installation	-35°C~60°C
Relative Humidity	< 95%RH (No Condensation)
Storage Temperature	-40°C~85°C
Storage Humidity	< 95%RH (No Condensation)
Manufacturing Test Temperature	-40°C~75°C
Ingress Protection Rating	IP20
Output Parameters	
Channel Number	4 channels
Resolution Ratio	16Bit
Output Range	0-20mA/4-20mA
The Output Precision	>0.3%
Diagnostic Function	Disconnection or overload, field power supply error
The common Terminal	0V grounded together, channels are not isolated
Conversion Time	2ms/ all channels
Load	Max.1KΩ

WARNING

UNEXPECTED EQUIPMENT OPERATION

Do not exceed any of the ratings specified in the environmental and electrical characteristics table.

Failure to follow instructions specified by the manufacturer may result in serious consequences such as death, personal injury, or damage to equipment since the protection provided by the equipment may be impaired.

 **AVERTISSEMENT**

FONCTIONNEMENT INATTENDU DE L'EQUIPEMENT

Ne dépassez aucune évaluation spécifiée dans le tableau de caractéristiques environnementales et électriques..

Le fait de ne pas suivre les instructions peut entraîner une défaillance de la protection fournie par l'équipement, ce qui peut entraîner des conséquences graves, comme des blessures ou des dommages à l'équipement.

3 Hardware interfaces

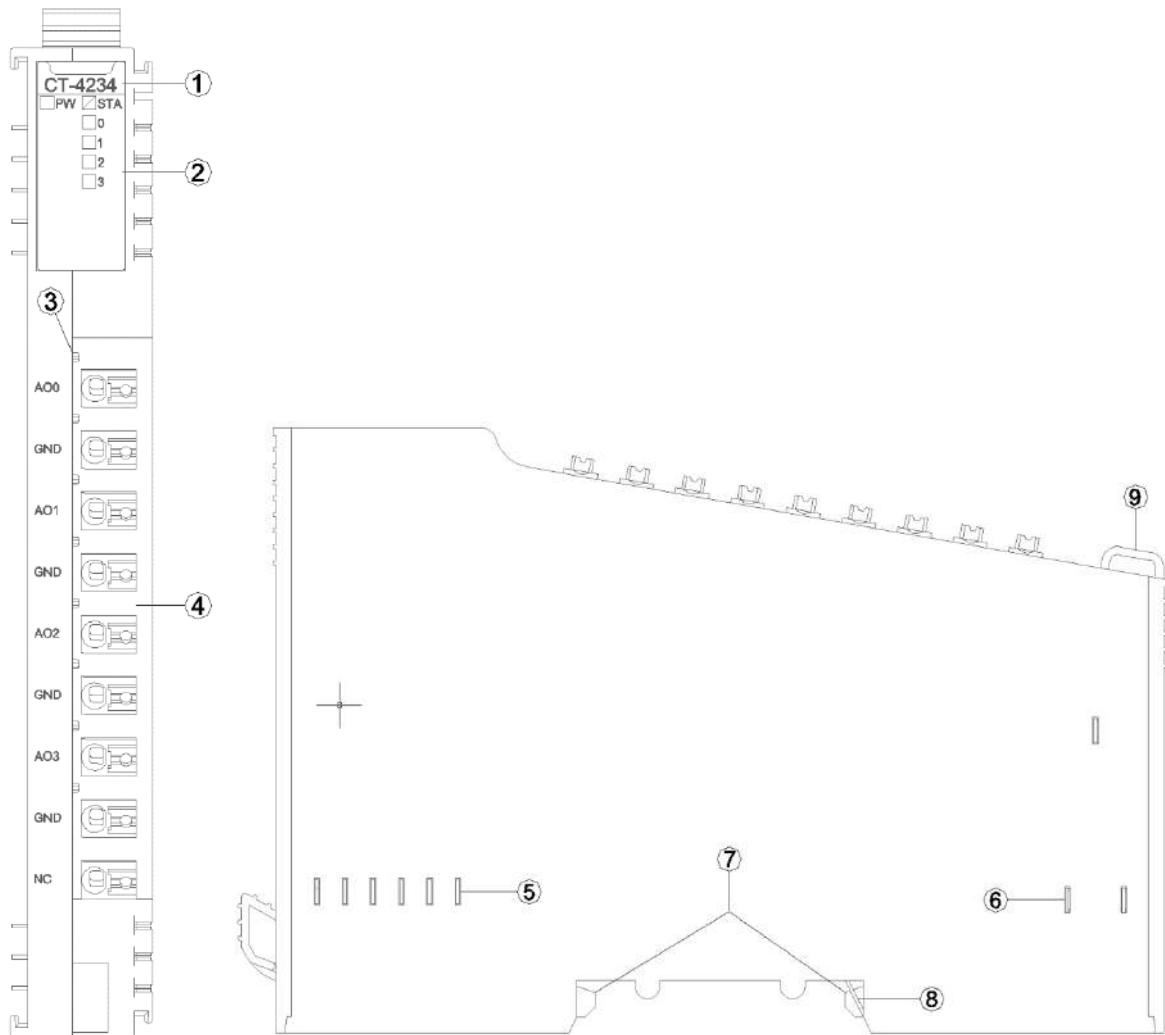

- ① Module Type
- ② State Indicator
- ③ (non field channel indicator)
- ④ Wiring Terminal and Marking
- ⑤ Internal Bus
- ⑥ Field Power
- ⑦ Buckle
- ⑧ Grounding Spring Sheet
- ⑨ Fixed Wiring Harness

3.1 LED indicators definition

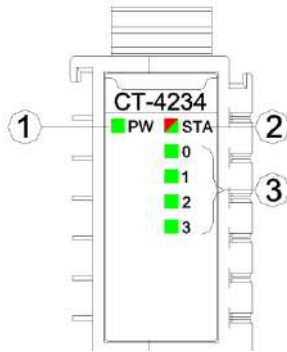

- ① Power LED indicator (green)
- ② Module State LED indicator (red/green)
- ③ Output channel LED indicator (green)

PW Power Indicator(GREEN)	Definition
ON	Internal bus power supply is normal
OFF	Internal bus power supply is failure
STA Module State Indicator (Red/Green)	Definition
Green Slow Flash (2.5hz)	The internal bus of the module is not started
Red Slow Flash (2.5hz)	Module internal bus offline
Green Normally On	Operation is normal
Flash(2.5Hz) (RED/GREEN)	Upgrading mode
Flash(10Hz) (RED/GREEN)	Firmware upgrading
Red Flashes Twice	Module exception has been soft-restarted
0-3 Channel Indicator	Definition
ON	Output signal $\geq 1\%$ range
OFF	Output signal $< 1\%$ range

! WARNING

UNEXPECTED EQUIPMENT OPERATION

By viewing the PW indicator, could determine the power supply status of a module. If the PW is steady green, the power supply is normal. Otherwise, the module cannot work properly.

When the module is initially powered on, there will be 3S for the backplane bus connection. After the backplane bus is initialized, STA is in the green steady state. If STA is in the green blinking state, it indicates that the backplane bus has not been initialized, and it needs to be powered off and restarted for re-initialization.

STA abnormal working state occurs during the normal operation of the module, please check the firmware version information of all modules, and consult ODOT technical support for details.

If a module is upgraded, check that all modules are in the normal state after the upgrade. Otherwise, an exception may occur.

Failure to follow instructions specified by the manufacturer may result in serious consequences such as death, personal injury, or damage to equipment since the protection provided by the equipment may be impaired.

AVERTISSEMENT

FONCTIONNEMENT INATTENDU DE L'EQUIPEMENT

En regardant l'état de l'indicateur de PW, jugez l'état d'alimentation du module. Le feu vert PW reste allumé et l'alimentation est normale. Autrement, le module ne fonctionnera pas correctement.

Lorsque le module est alimenté initialement, il y aura 3S pour la connexion de bus de backboard. STA est un état vert permanent après l'initialisation du bus de backboard. Si STA est en état de clignotement vert, cela signifie que l'initialisation du bus de backboard n'est pas passée et doit être redémarrée hors tension et réinitialisée.

L'état de fonctionnement anormal de STA se produit pendant le fonctionnement normal du module, veuillez vérifier les informations de version du firmware de tous les modules, et consulter le support technique ODOT pour plus de détails.

Si le module a une opération de mise à niveau, après l'achèvement de la mise à niveau, le besoin de vérifier que tous les modules sont dans l'état normal avant de courir, sinon il conduira à une exception.

Le fait de ne pas suivre les instructions peut entraîner une défaillance de la protection fournie par l'équipement, ce qui peut entraîner des conséquences graves, comme des blessures ou des dommages à l'équipement.

3.2 Terminal definition

Terminal number	Definition	Instructions
1	AO0	Current output CH0
2	GND	
3	AO1	Current output CH1
4	GND	
5	AO2	Current output CH2
6	GND	
7	AO3	Current output CH3
8	GND	
9	NC	Disconnected

! WARNING

UNEXPECTED EQUIPMENT OPERATION

Calculate the maximum field power current consumption of a single module based on the actual field load. If the total field power current consumption of all I/O modules exceeds the power supply capacity of the field power supply, you must add an extra power expansion module. Otherwise, an output channel exception may occur.

Failure to follow instructions specified by the manufacturer may result in serious consequences such as death, personal injury, or damage to equipment since the protection provided by the equipment may be impaired.

! AVERTISSEMENT

FONCTIONNEMENT INATTENDU DE L'EQUIPEMENT

Calculez la consommation maximale de courant de champ d'un seul module en fonction de la charge de champ réelle. Si la consommation totale de courant de champ de tous les modules d'E/S dépasse la capacité d'alimentation de l'alimentation de champ, vous devez ajouter un module d'extension de puissance supplémentaire. Dans le cas contraire, une exception de canal de sortie peut se produire.

Le fait de ne pas suivre les instructions peut entraîner une défaillance de la protection fournie par l'équipement, ce qui peut entraîner des conséquences graves, comme des blessures ou des dommages à l'équipement.

When connecting a cold-pressed terminal, the terminal must be terminated and checked in strict accordance with the corresponding termination specifications or requirements, and connect the cold-pressed terminal according to the corresponding node serial number. The conductor should use copper conductor and the conductor core should be larger than 0.2mm^2 and smaller than 1mm^2 (AWG18~AWG24). Cold-pressed terminal parameters are as follows:

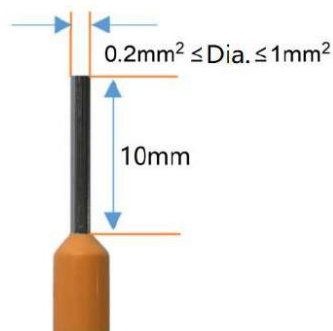

WARNING

UNEXPECTED EQUIPMENT OPERATION

Strip the length of the conductor insulation layer is greater than 10mm to ensure reliable signal connection.

The wire needs to use copper wire and the wire core is greater than or equal to 0.2mm² and less than or equal to 1mm² to ensure reliable signal connection.

When connecting a cold-press terminal, connect the cold-press terminal strictly in accordance with the corresponding termination specifications or requirements, and connect the cold-press terminal according to the corresponding node serial number.

Do not power on cold-press terminals until they are properly connected or fully locked.

Failure to follow instructions specified by the manufacturer may result in serious consequences such as death, personal injury, or damage to equipment since the protection provided by the equipment may be impaired.

AVERTISSEMENT

FONCTIONNEMENT INATTENDU DE L'EQUIPEMENT

Dépouillez la longueur de la couche isolante du fil plus de 10mm pour assurer la connexion fiable du signal.

Le conducteur doit utiliser le fil de cuivre et le noyau de fil est supérieur ou égal à 0,2 mm², inférieur ou égal à 1mm², afin d'assurer la connexion fiable du signal.

Lorsque les terminaux de presse à froid sont terminés, ils doivent être terminés et visualisés en stricte conformité avec les spécifications ou les exigences correspondantes et terminés selon le numéro de série de noeud correspondant.

Il est interdit d'activer les bornes à froid avant qu'elles ne soient correctement articulées ou complètement verrouillées.

Le fait de ne pas suivre les instructions peut entraîner une défaillance de la protection fournie par l'équipement, ce qui peut entraîner des conséquences graves, comme des blessures ou des dommages à l'équipement.

DANGER

FIRE DANGER

Use the correct wiring rules only for the maximum current capacity of the I/O channel and power supply.

Failure to follow instructions specified by the manufacturer may result in serious consequences such as death, personal injury, or damage to equipment since the protection provided by the equipment may be impaired.

 **WARNING**

UNEXPECTED EQUIPMENT OPERATION

Do not exceed any of the ratings specified in the environmental and electrical characteristics table.

Failure to follow instructions specified by the manufacturer may result in serious consequences such as death, personal injury, or damage to equipment since the protection provided by the equipment may be impaired.

 **AVERTISSEMENT**

FONCTIONNEMENT INATTENDU DE L'EQUIPEMENT

Ne dépassez aucune évaluation spécifiée dans le tableau de caractéristiques environnementales et électriques..

Le fait de ne pas suivre les instructions peut entraîner une défaillance de la protection fournie par l'équipement, ce qui peut entraîner des conséquences graves, comme des blessures ou des dommages à l'équipement.

4 Wiring

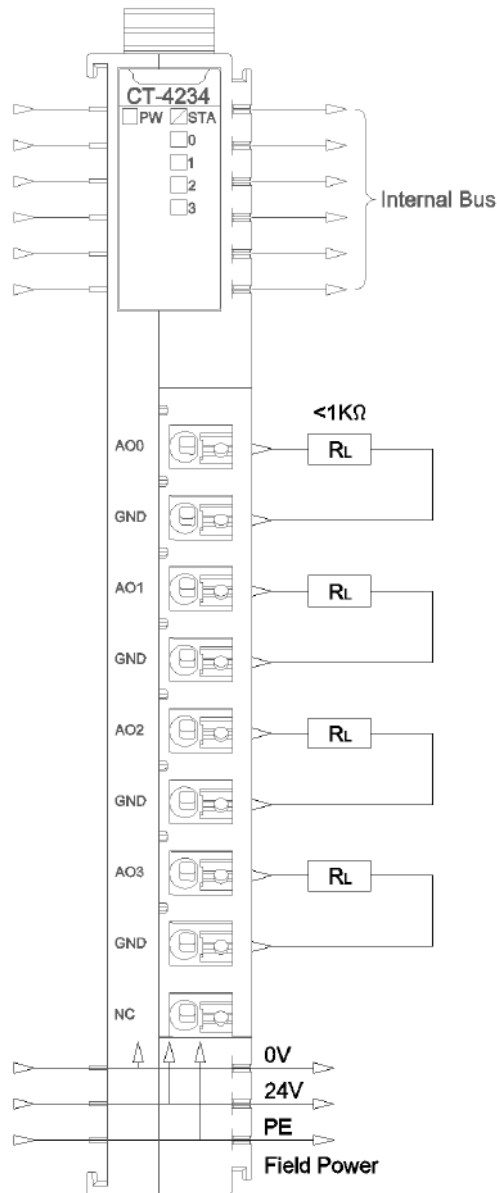

NOTICE

EQUIPMENT INOPERABLE

Do not crimp the spring terminal with more than the maximum pressure specified for the terminal. Otherwise, the resilience of the spring terminal may be damaged and the terminal rebound may be affected.

Do not press the spring terminal with a sharp tool when removing cable from the channel. Otherwise, the spring terminal will be damaged.

Failure to follow these instructions may result in equipment damage.

 **WARNING**

UNEXPECTED EQUIPMENT OPERATION

Do not link wires to unused terminals and/or terminals marked "NO CONNECTION (NC)".

Failure to follow instructions specified by the manufacturer may result in serious consequences such as death, personal injury, or damage to equipment since the protection provided by the equipment may be impaired.

 **AVERTISSEMENT**

FONCTIONNEMENT INATTENDU DE L'EQUIPEMENT

Ne liez pas les fils aux bornes inutilisées et/ou aux bornes marquées «NO CONNECTION (NC)».

Le fait de ne pas suivre les instructions peut entraîner une défaillance de la protection fournie par l'équipement, ce qui peut entraîner des conséquences graves, comme des blessures ou des dommages à l'équipement.

5 Progress data definition

Input data								
Bit No	Bit 7	Bit 6	Bit 5	Bit 4	Bit 3	Bit 2	Bit 1	Bit 0
Byte 0	Reserved		Field Power Error (CH0-3)	DAC Communication Error (CH0-3)	Output Opening or Overload (CH3)	Output Opening or Overload (CH2)	Output Opening or Overload (CH1)	Output Opening or Overload (CH0)
Output data								
Bit No	Bit 7	Bit 6	Bit 5	Bit 4	Bit 3	Bit 2	Bit 1	Bit 0
Byte 0	Analog Output Data (CH 0)							
Byte 1								
Byte 2	Analog Output Data (CH 1)							
Byte 3								
Byte 4	Analog Output Data (CH 2)							
Byte 5								
Byte 6	Analog Output Data (CH 3)							
Byte 7								

Data description:

Output Opening or Overload (CH0-3): Current output diagnostic State, when the corresponding Output channel is open or overloaded, this bit is set to 1, and it will be automatically cleared when the load returns to normal.

0: normal is load

1: open load or overload

DAC Communication Error(CH0-3): DAC converter Communication is Error. This Error will occur when the field power supply is disconnected or the DAC and isolator are damaged.

0: DAC communication is normal

1: DAC conversion failed

Field Power Error (CH0-3): This Error will occur when the Field Power is not powered on.

0: field power access is normal

1: field power access is failure

Analog Output Data(CH0-3): Analog Output value, 16-bit unsigned integer.

5.1 Process data definition (standard mode)

Analog Output Data(CT-4234) (0-20mA)			
Current (0-20mA)	Decimal	Hex	Range
21mA	32767	7FFF	Overflow
	29031	7167	
21mA	29030	7166	Exceeds the upper limit
20mA+723.4nA	27649	6C01	
20mA	27648	6C00	Rated range
15mA	20736	5100	
723.4nA	1	1	
0 mA	0	0	
0 mA	-1	FFFF	Underflow
	-32768	8000	

Analog Output Data(CT-4234) (4-20mA)			
Current (4-20mA)	Decimal	Hex	Range
21mA	32767	7FFF	Overflow
	29377	72C1	
21mA	29376	72C0	Exceeds the upper limit
20mA+578.7nA	27649	6C01	
20 mA	27648	6C00	Rated range
16 mA	19008	4A40	
4mA +578.7nA	1	1	
4mA	0	0	
3.9995mA	-1	FFFF	Exceeds the lower limit
3.6mA	-692	FD4C	
3.6mA	-693	FD4B	Underflow
	-32768	8000	

5.2 Process data definition (special mode)

Analog Output Data (CT-4234)			
Current (0 to 20 mA)	Current (4-20 mA)	Decimal 16 bits	Hexadecimal 16 bits
20	20	65535	0xFFFF
.	.	.	.
.	.	.	.
.	.	.	.
10	12	32767	0x7FFF
.	.	.	.
.	.	.	.
.	.	.	.
0	4	0	0x0000

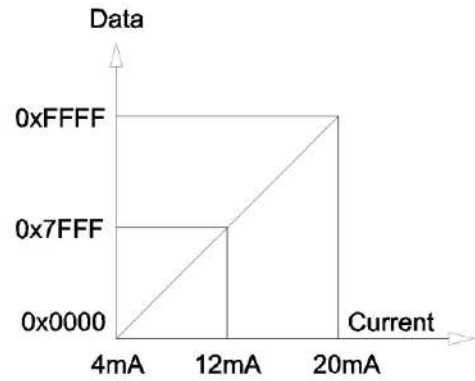
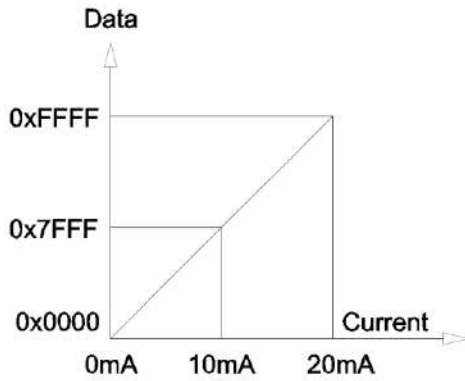

16Bit Data/Current

6 Configuration parameter definition

Configuration parameter								
Bit No	Bit 7	Bit 6	Bit 5	Bit 4	Bit 3	Bit 2	Bit 1	Bit 0
Byte 0	Reserved						Range_Mode	16Bit Data Format
Byte 1	Reserved				Current Type CH3	Current Type CH2	Current Type CH1	Current Type CH0

Data description:

16Bit Data Format: Analog data storage format. (Default: 0)

0: A-B

1: B-A

Range_Mode: Process data mode (default: standard mode)

Standard mode: same with Siemens process data definition

Special mode: max range of the hardware

Current Type(CH0-3): Type of output current. (Default: 1)

0: 0-20mA

1: 4-20mA



WARNING

UNEXPECTED EQUIPMENT OPERATION

Adjust the output current type parameters according to the site conditions. If the parameters are improperly set, the output signal will be incorrect.

Failure to follow instructions specified by the manufacturer may result in serious consequences such as death, personal injury, or damage to equipment since the protection provided by the equipment may be impaired.

 **AVERTISSEMENT**

FONCTIONNEMENT INATTENDU DE L'EQUIPEMENT

Les paramètres de type de courant de sortie peuvent être ajustés en fonction des conditions du site. Si les paramètres ne sont pas réglés correctement, le signal de sortie sera erroné.

Le fait de ne pas suivre les instructions peut entraîner une défaillance de la protection fournie par l'équipement, ce qui peut entraîner des conséquences graves, comme des blessures ou des dommages à l'équipement.

A Dimension drawing

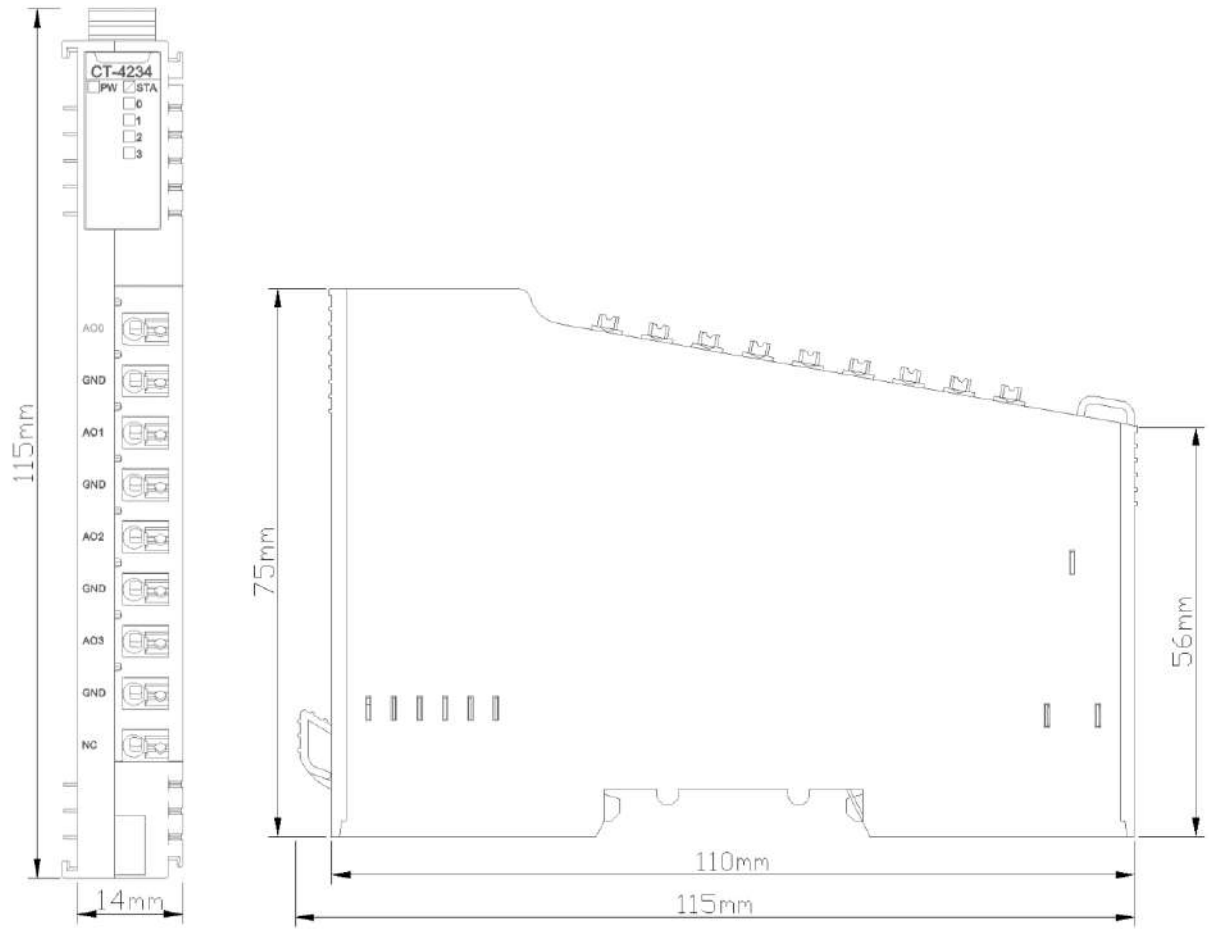

CT-4238 8 channel analog output /0&4-20mA/16 bit

1 Module features

- ◆ The module output range could be set to 0-20 mA or 4-20 mA
- ◆ The internal bus of the module is isolated from the field output
- ◆ The module adopts single terminal common ground output mode
- ◆ The module output accuracy 0.1% (full scale @25°C), 0.3% (full scale @-35°C ~70°C)

2 Technical parameters

General parameter	
Power	Max.140mA@5.0VDC/25°C
Isolation	The isolation voltage between I/O module and system power is AC500V The isolation voltage between I/O module and PE is AC500V The isolation voltage between field power and PE is AC500V
Field Power	/
Wiring	Max.: AWG 18 Min.: AWG 24
Mounting Type	35mm DIN-Rail
Size	115*14*75mm
Weight	65g
Environment parameter	
Operation Temperature	-35~70°C
Environment Humidity	5%~95% no condensation
Ingress Protection Rating	IP20
Output parameter	
Channel Number	8-channel
Indicator	8 panel indicators, 1 power indicator, 1 two-color indicator
Resolution Ratio	16 Bit
Output Accuracy	0.1% @25°C , 0.3% @-35°C~70°C
Diagnostic Function	Disconnected, open/overload
Common Terminal	0V common ground, channels are not isolated
Conversation	2ms/All channels
Load	Max.1KΩ
EMC parameter	
Static	Contact 4KV/Air 8KV
EFT	2KV
Surge	2KV

WARNING

UNEXPECTED EQUIPMENT OPERATION

Do not exceed any of the ratings specified in the environmental and electrical characteristics table.

Failure to follow instructions specified by the manufacturer may result in serious consequences such as death, personal injury, or damage to equipment since the protection provided by the equipment may be impaired.

 **AVERTISSEMENT**

FONCTIONNEMENT INATTENDU DE L'EQUIPEMENT

Ne dépassez aucune évaluation spécifiée dans le tableau de caractéristiques environnementales et électriques..

Le fait de ne pas suivre les instructions peut entraîner une défaillance de la protection fournie par l'équipement, ce qui peut entraîner des conséquences graves, comme des blessures ou des dommages à l'équipement.

3 Hardware interfaces

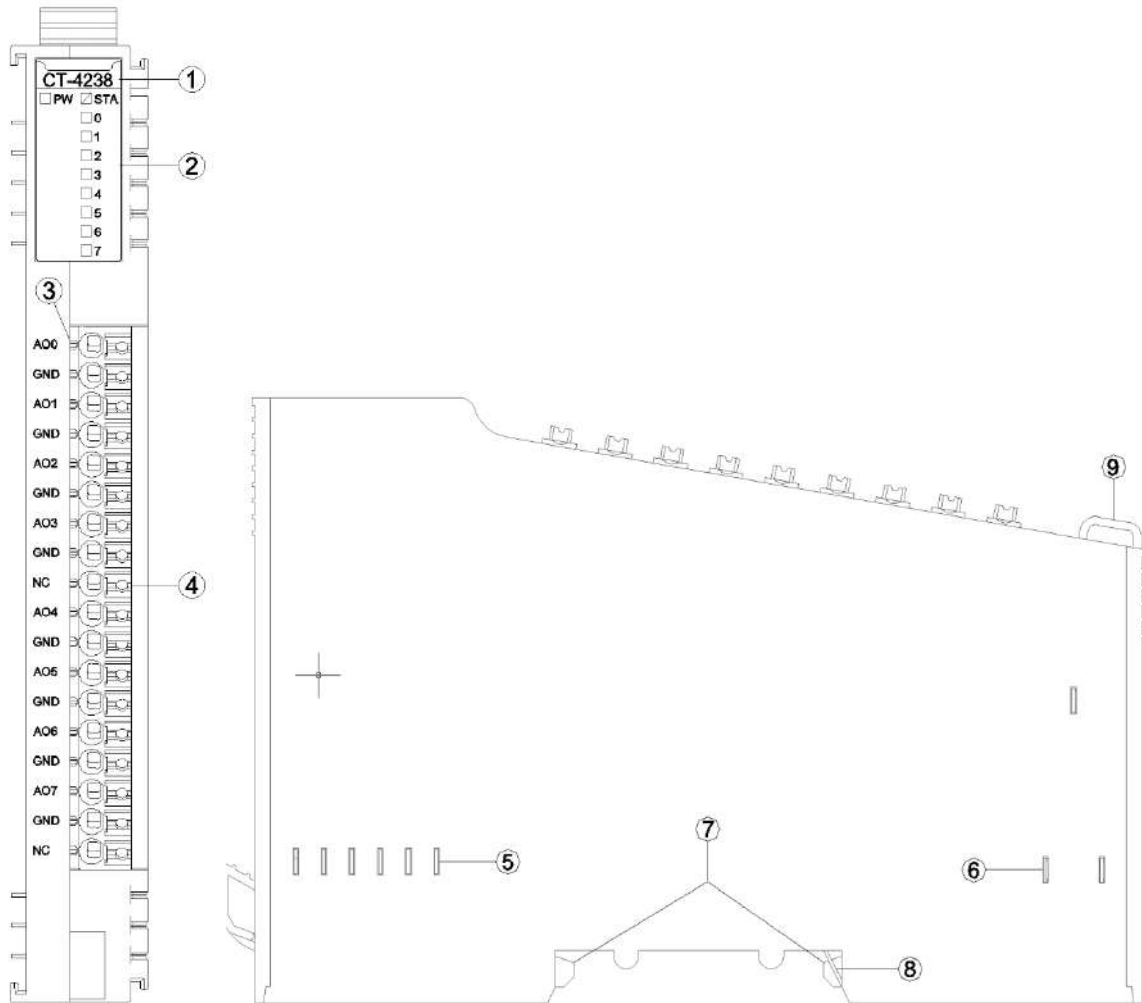

- ① Module type
- ② State indicator
- ③ (N/A)
- ④ Wiring terminal and Marking
- ⑤ Internal bus
- ⑥ Field power
- ⑦ buckle
- ⑧ Ground spring sheet
- ⑨ Fixed wiring harness

3.1 LED indicator definition

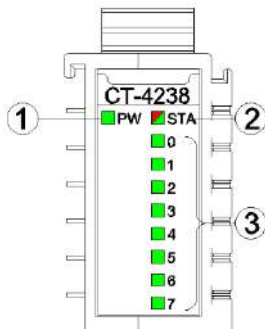

- ① Power indicator (GREEN)
- ② Module state indicator (RED/GREEN)
- ③ Output channel indicator (GREEN)

PW Power indicator (GREEN)	Definition
ON	Internal bus supply normal
OFF	Internal bus supply abnormal
STA Module state indicator (RED/GREEN)	Definition
Slow flash (2.5Hz) (GREEN)	Module internal bus is not started
Slow flash (2.5Hz) (RED)	Module internal bus is offline
ON (GREEN)	Module operation normal
Flash (2.5Hz) (RED/GREEN)	Upgrading mode
Flash (10Hz) (RED/GREEN)	Firmware upgrading
Double flash (RED)	Module exception has been soft-restarted
0-7 Channel indicator (GREEN)	Definition
ON	Output signal $\geq 1\%$ range
OFF	Output signal $< 1\%$ range

⚠ WARNING

UNEXPECTED EQUIPMENT OPERATION

By viewing the PW indicator, could determine the power supply status of a module. If the PW is steady green, the power supply is normal. Otherwise, the module cannot work properly.

When the module is initially powered on, there will be 3S for the backplane bus connection. After the backplane bus is initialized, STA is in the green steady state. If STA is in the green blinking state, it indicates that the backplane bus has not been initialized, and it needs to be powered off and restarted for re-initialization.

STA abnormal working state occurs during the normal operation of the module, please check the firmware version information of all modules, and consult ODOT technical support for details.

If a module is upgraded, check that all modules are in the normal state after the upgrade. Otherwise, an exception may occur.

Failure to follow instructions specified by the manufacturer may result in serious consequences such as death, personal injury, or damage to equipment since the protection provided by the equipment may be impaired.

AVERTISSEMENT

FONCTIONNEMENT INATTENDU DE L'EQUIPEMENT

En regardant l'état de l'indicateur de PW, jugez l'état d'alimentation du module. Le feu vert PW reste allumé et l'alimentation est normale. Autrement, le module ne fonctionnera pas correctement.

Lorsque le module est alimenté initialement, il y aura 3S pour la connexion de bus de backboard. STA est un état vert permanent après l'initialisation du bus de backboard. Si STA est en état de clignotement vert, cela signifie que l'initialisation du bus de backboard n'est pas passée et doit être redémarrée hors tension et réinitialisée.

L'état de fonctionnement anormal de STA se produit pendant le fonctionnement normal du module, veuillez vérifier les informations de version du firmware de tous les modules, et consulter le support technique ODOT pour plus de détails.

Si le module a une opération de mise à niveau, après l'achèvement de la mise à niveau, le besoin de vérifier que tous les modules sont dans l'état normal avant de courir, sinon il conduira à une exception.

Le fait de ne pas suivre les instructions peut entraîner une défaillance de la protection fournie par l'équipement, ce qui peut entraîner des conséquences graves, comme des blessures ou des dommages à l'équipement.

3.2 Wiring terminal definition

NO.	Definition	Instruction
1	AO0	Current output CH0
2	GND	
3	AO1	Current output CH1
4	GND	
5	AO2	Current output CH2
6	GND	
7	AO3	Current output CH3
8	GND	
9	NC	No connection
10	AO4	Current output CH4
11	GND	
12	AO5	Current output CH5
13	GND	
14	AO6	Current output CH6
15	GND	
16	AO7	Current output CH7
17	GND	
18	NC	No connection

WARNING

UNEXPECTED EQUIPMENT OPERATION

Calculate the maximum field power current consumption of a single module based on the actual field load. If the total field power current consumption of all I/O modules exceeds the power supply capacity of the field power supply, you must add an extra power expansion module. Otherwise, an output channel exception may occur.

Failure to follow instructions specified by the manufacturer may result in serious consequences such as death, personal injury, or damage to equipment since the protection provided by the equipment may be impaired.

AVERTISSEMENT

FONCTIONNEMENT INATTENDU DE L'EQUIPEMENT

Calculez la consommation maximale de courant de champ d'un seul module en fonction de la charge de champ réelle. Si la consommation totale de courant de champ de tous les modules d'E/S dépasse la capacité d'alimentation de l'alimentation de champ, vous devez ajouter un module d'extension de puissance supplémentaire. Dans le cas contraire, une exception de canal de sortie peut se produire.

Le fait de ne pas suivre les instructions peut entraîner une défaillance de la protection fournie

par l'équipement, ce qui peut entraîner des conséquences graves, comme des blessures ou des dommages à l'équipement.

When connecting a cold-pressed terminal, the terminal must be terminated and checked in strict accordance with the corresponding termination specifications or requirements, and connect the cold-pressed terminal according to the corresponding node serial number. The conductor should use copper conductor and the conductor core should be larger than 0.2mm^2 and smaller than 1mm^2 (AWG18~AWG24). Cold-pressed terminal parameters are as follows:

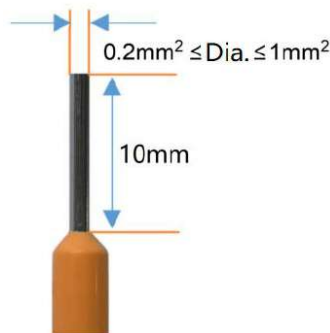

⚠️ WARNING

UNEXPECTED EQUIPMENT OPERATION

Strip the length of the conductor insulation layer is greater than 10mm to ensure reliable signal connection.

The wire needs to use copper wire and the wire core is greater than or equal to 0.2mm^2 and less than or equal to 1mm^2 to ensure reliable signal connection.

When connecting a cold-press terminal, connect the cold-press terminal strictly in accordance with the corresponding termination specifications or requirements, and connect the cold-press terminal according to the corresponding node serial number.

Do not power on cold-press terminals until they are properly connected or fully locked.

Failure to follow instructions specified by the manufacturer may result in serious consequences such as death, personal injury, or damage to equipment since the protection provided by the equipment may be impaired.

⚠️ AVERTISSEMENT

FONCTIONNEMENT INATTENDU DE L'EQUIPEMENT

Dépouillez la longueur de la couche isolante du fil plus de 10mm pour assurer la connexion fiable du signal.

Le conducteur doit utiliser le fil de cuivre et le noyau de fil est supérieur ou égal à $0,2\text{ mm}^2$,

inférieur ou égal à 1mm², afin d'assurer la connexion fiable du signal.

Lorsque les terminaux de presse à froid sont terminés, ils doivent être terminés et visualisés en stricte conformité avec les spécifications ou les exigences correspondantes et terminés selon le numéro de série de noeud correspondant.

Il est interdit d'activer les bornes à froid avant qu'elles ne soient correctement articulées ou complètement verrouillées.

Le fait de ne pas suivre les instructions peut entraîner une défaillance de la protection fournie par l'équipement, ce qui peut entraîner des conséquences graves, comme des blessures ou des dommages à l'équipement.

DANGER

FIRE DANGER

Use the correct wiring rules only for the maximum current capacity of the I/O channel and power supply.

Failure to follow instructions specified by the manufacturer may result in serious consequences such as death, personal injury, or damage to equipment since the protection provided by the equipment may be impaired.

WARNING

UNEXPECTED EQUIPMENT OPERATION

Do not exceed any of the ratings specified in the environmental and electrical characteristics table.

Failure to follow instructions specified by the manufacturer may result in serious consequences such as death, personal injury, or damage to equipment since the protection provided by the equipment may be impaired.

AVERTISSEMENT

FONCTIONNEMENT INATTENDU DE L'EQUIPEMENT

Ne dépassez aucune évaluation spécifiée dans le tableau de caractéristiques environnementales et électriques..

Le fait de ne pas suivre les instructions peut entraîner une défaillance de la protection fournie par l'équipement, ce qui peut entraîner des conséquences graves, comme des blessures ou des dommages à l'équipement.

4 Wiring

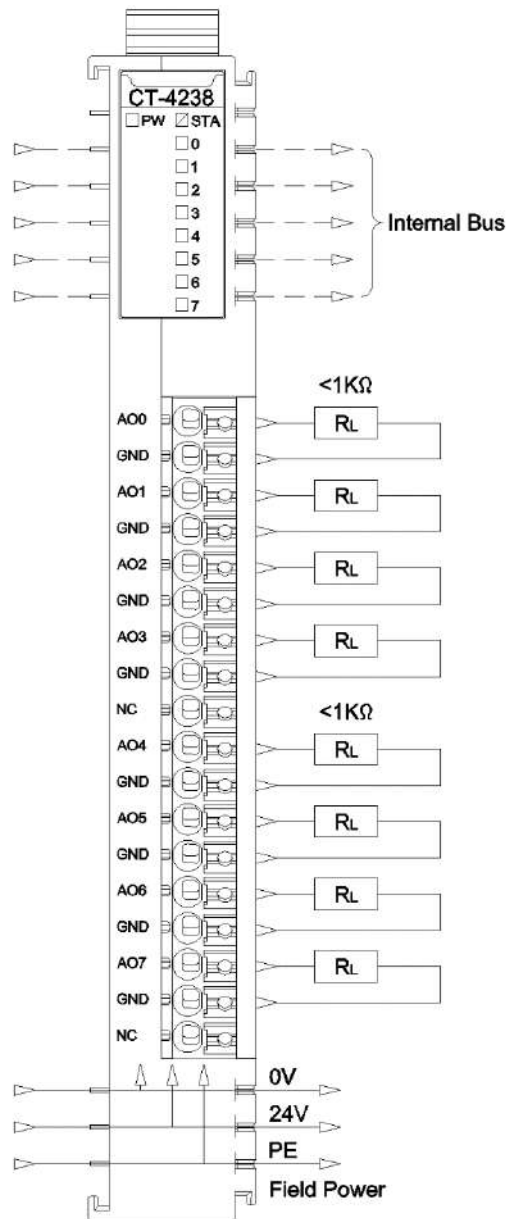

NOTICE

EQUIPMENT INOPERABLE

Do not crimp the spring terminal with more than the maximum pressure specified for the terminal. Otherwise, the resilience of the spring terminal may be damaged and the terminal rebound may be affected.

Do not press the spring terminal with a sharp tool when removing cable from the channel. Otherwise, the spring terminal will be damaged.

Failure to follow these instructions may result in equipment damage.

 **WARNING**

UNEXPECTED EQUIPMENT OPERATION

Do not link wires to unused terminals and/or terminals marked "NO CONNECTION (NC)".

Failure to follow instructions specified by the manufacturer may result in serious consequences such as death, personal injury, or damage to equipment since the protection provided by the equipment may be impaired.

 **AVERTISSEMENT**

FONCTIONNEMENT INATTENDU DE L'EQUIPEMENT

Ne liez pas les fils aux bornes inutilisées et/ou aux bornes marquées «NO CONNECTION (NC)».

Le fait de ne pas suivre les instructions peut entraîner une défaillance de la protection fournie par l'équipement, ce qui peut entraîner des conséquences graves, comme des blessures ou des dommages à l'équipement.

5 Process data definition

Input data								
Bit No	Bit 7	Bit 6	Bit 5	Bit 4	Bit 3	Bit 2	Bit 1	Bit 0
Byte 0	Output Opening or Overload (CH7)	Output Opening or Overload (CH6)	Output Opening or Overload (CH5)	Output Opening or Overload (CH4)	Output Opening or Overload (CH3)	Output Opening or Overload (CH2)	Output Opening or Overload (CH1)	Output Opening or Overload (CH0)
Byte 1	Reserved							DAC Communication Error (CH0~CH7)
Output data								
Bit No	Bit 7	Bit 6	Bit 5	Bit 4	Bit 3	Bit 2	Bit 1	Bit 0
Byte 0	Analog Output Data (CH 0)							
Byte 1								
Byte 2	Analog Output Data (CH 1)							
Byte 3								
Byte 4	Analog Output Data (CH 2)							
Byte 5								
Byte 6	Analog Output Data (CH 3)							
Byte 7								
Byte 8	Analog Output Data (CH 4)							
Byte 9								
Byte 10	Analog Output Data (CH 5)							
Byte 11								
Byte 12	Analog Output Data (CH 6)							
Byte 13								
Byte 14	Analog Output Data (CH 7)							
Byte 15								

Data description:

Output Opening or Overload (CH0-7): Current output diagnostic state, when the corresponding output channel is open or overloaded, the position 1 is automatically cleared after the load is normal.

0: Normal load

1: The load is open or overloaded

DAC Communication Error(CH0-3): DAC converter communication error, this error occurs when the field power supply is not connected or the DAC, isolator, etc., is

damaged.

0: DAC communication normal

1: DAC conversation failure

Analog Output Data(CH0-7): Analog output value, 16 bit unsigned integer.

5.1 Process data definition (standard mode)

Analog Output Data (CT-4238) (0-20mA)			
Current (0-20mA)	Decimal	Hexadecimal	Range
21mA	32767	7FFF	Overflow
	29031	7167	
21mA	29030	7166	Exceeds the upper limit
20mA+723.4nA	27649	6C01	
20mA	27648	6C00	Rated range
15mA	20736	5100	
723.4nA	1	1	
0 mA	0	0	
0 mA	-1	FFFF	下溢
	-32768	8000	

Analog Output Data (CT-4238) (4-20mA)			
Current (4-20mA)	Decimal	Hexadecimal	Range
21mA	32767	7FFF	Overflow
	29377	72C1	
21mA	29376	72C0	Exceeds the upper limit
20mA+578.7nA	27649	6C01	
20 mA	27648	6C00	Rated range
16 mA	20736	5100	
4mA +578.7nA	1	1	
4mA	0	0	
3.9995mA	-1	FFFF	Exceeds the lower limit
3.6mA	-692	FD4C	
3.6mA	-693	FD4B	underflow
	-32768	8000	

5.2 Process data definition (special mode)

Analog Output Data(CT-4238)			
Current (0-20mA)	Current (4-20mA)	Decimal 16 bit	Hexadecimal 16 bit
20 mA	20 mA	65535	0xFFFF
.	.	.	.
.	.	.	.
.	.	.	.
10 mA	12 mA	32767	0x7FFF
.	.	.	.
.	.	.	.
.	.	.	.
0 mA	4 mA	0	0x0000

6 Configuration parameter definition

Configuration parameter								
Bit No	Bit 7	Bit 6	Bit 5	Bit 4	Bit 3	Bit 2	Bit 1	Bit 0
Byte 0	Reserved					Analog Output Fault Action	Range_Mode	16Bit Data Format
Byte 1	Current Type CH7	Current Type CH6	Current Type CH5	Current Type CH4	Current Type CH3	Current Type CH2	Current Type CH1	Current Type CH0

Data description:

16Bit Data Format: analog data storage format. (Default: 0)

0: A-B

1: B-A

Range_Mode: process data mode. (Default: standard mode)

Standard mode: Siemens' process data definition is the same

Special mode: Maximum hardware range

Analog Output Fault Action: Troubleshooting the module offline output fault (Default:

1)

0: Keep the last output value

1: Clear the output value

Current Type(CH0-3): Type of current output. (Default: 1)

0: 0-20mA

1: 4-20mA

WARNING

UNEXPECTED EQUIPMENT OPERATION

Adjust the output current type parameters according to the site conditions. If the parameters are improperly set, the output signal will be incorrect.

Failure to follow instructions specified by the manufacturer may result in serious consequences such as death, personal injury, or damage to equipment since the protection provided by the equipment may be impaired.

 **AVERTISSEMENT**

FONCTIONNEMENT INATTENDU DE L'EQUIPEMENT

Les paramètres de type de courant de sortie peuvent être ajustés en fonction des conditions du site. Si les paramètres ne sont pas réglés correctement, le signal de sortie sera erroné..

Le fait de ne pas suivre les instructions peut entraîner une défaillance de la protection fournie par l'équipement, ce qui peut entraîner des conséquences graves, comme des blessures ou des dommages à l'équipement.

A Dimension drawing

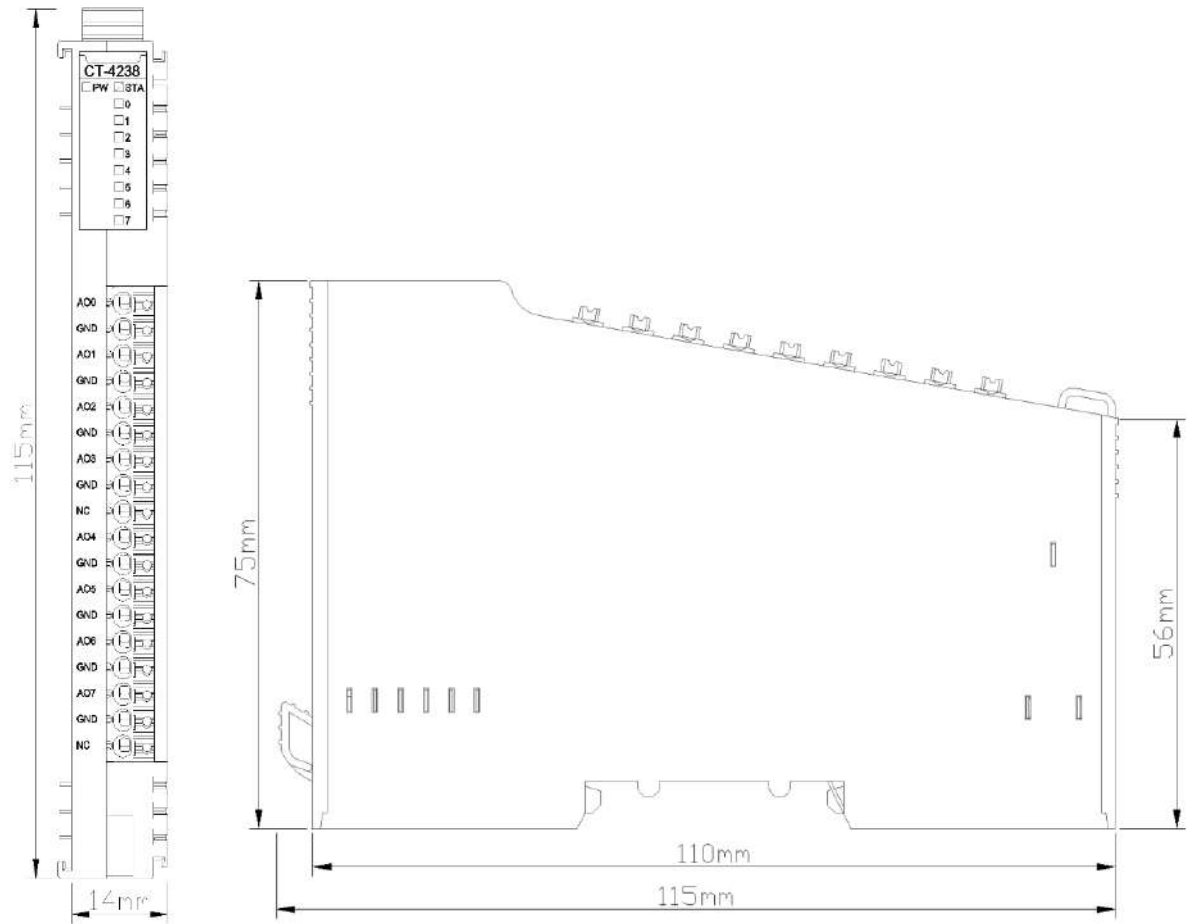

CT-5000 Virtual module

1 Module feature

- ◆ Module no wiring, no channel
- ◆ Modules could be used to occupy slots
- ◆ Module submodule instructions could be used to placeholder process data addresses

2 Technical parameters

General Parameter	
Power	Max.30mA@5.0VDC
Isolation	I/O to internal bus: magnetic isolation (3KVrms)
Filed Power	Nominal: 24VDC Input range: 20.4~28.8VDC
Wiring	N/A
Mounting Type	35mm DIN-Rail
Size	115*14*75mm
Weight	50g
Environment parameter	
Operating temperature of horizontal installation	-35°C~70°C
Operating temperature of vertical installation	-35°C~60°C
relative humidity	<95%RH No condensation
Storage temperature	-40°C~85°C
Storage humidity	<95%RH No condensation
Manufacturing test temperature	-40°C~75°C
Ingress Protection Rating	IP20
Virtual Parameter	
Individual input instruction data length	Max: 16 bytes Max: 16 words Max: 16 Double words
Individual output instruction data length	Max: 16 bytes Max: 16 words Max: 16 Double words
Number of input and output instructions	Max: 10

 **WARNING**

UNEXPECTED EQUIPMENT OPERATION

Do not exceed any of the ratings specified in the environmental and electrical characteristics table.

Failure to follow instructions specified by the manufacturer may result in serious consequences such as death, personal injury, or damage to equipment since the protection provided by the equipment may be impaired.

 **AVERTISSEMENT**

FONCTIONNEMENT INATTENDU DE L'EQUIPEMENT

Ne dépassez aucune évaluation spécifiée dans le tableau de caractéristiques environnementales et électriques..

Le fait de ne pas suivre les instructions peut entraîner une défaillance de la protection fournie par l'équipement, ce qui peut entraîner des conséquences graves, comme des blessures ou des dommages à l'équipement.

3 Hardware Interfaces

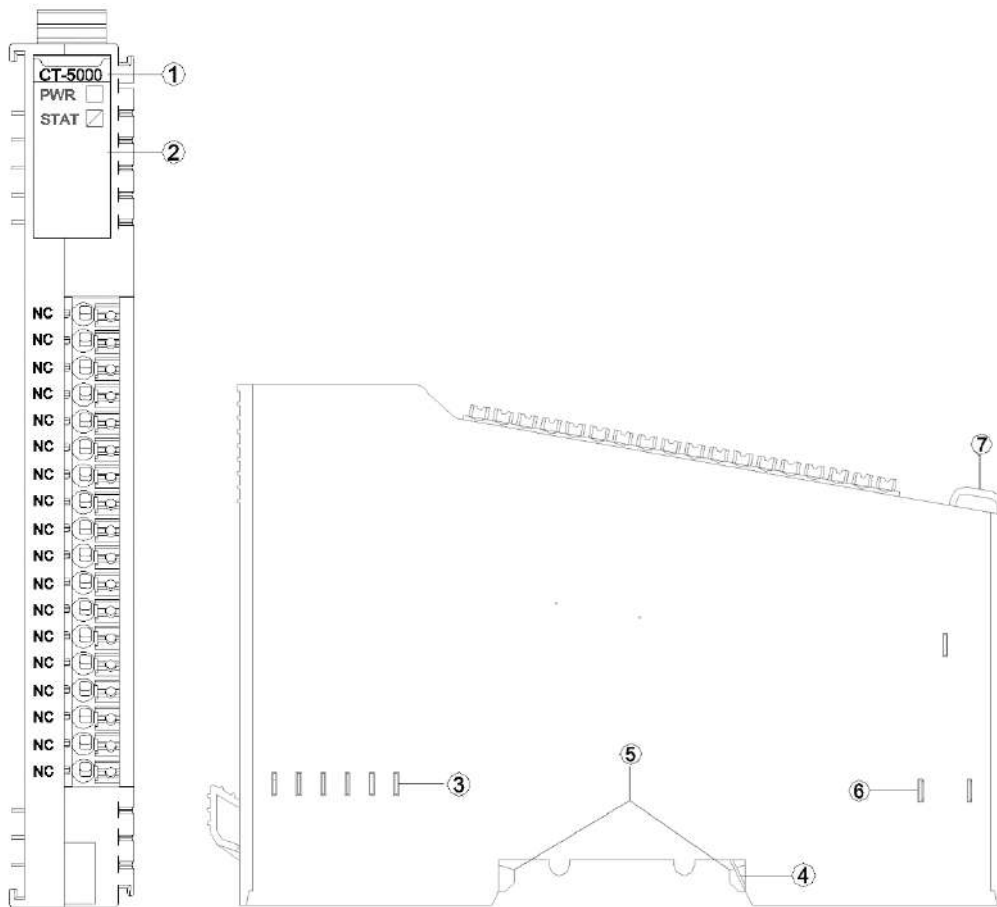

- ① Module type
- ② State indicator
- ③ Internal bus
- ④ Grounding Spring Sheet
- ⑤ Buckle
- ⑥ Field power
- ⑦ Fixed Wiring Harness

3.1 LED Indicator definition

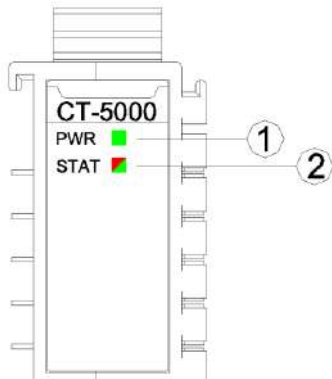

- ① Power indicator (GREEN)
- ② Module state indicator (RED/GREEN)

PW Power indicator	Instruction
ON	Internal bus supply normal
OFF	Internal bus supply abnormal
STA Module state indicator	Instruction
Slow flash (2.5Hz) (GREEN)	Module internal bus is not started
Slow flash (2.5Hz) (RED)	Module internal bus offline
ON(GREEN)	Module operation normal
Flash (2.5Hz) (RED/GREEN)	Updating mode
Flash (10Hz) (RED/GREEN)	Firmware update
Double flash (RED)	Module exception has been soft-restarted

3.2 Wiring terminal definition

NO.	Definition	Instruction
1-18	NC	No cable needed

4 Wiring

N/A

5 Process data definition

N/A

6 Configuration parameter definition

6.1 CT-5000 Submodule parameter definition

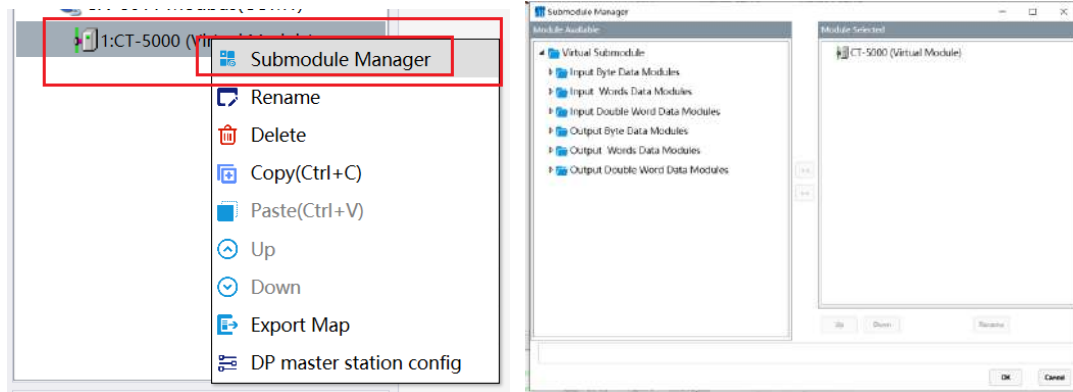

CT-5000 Submodule could add:

1. Input bytes
2. Input words
3. Input double word
4. Output bytes
5. Output word
6. Output double word

Add the maximum number of inputs and outputs of the CT-5000 submodule to 10

A Dimension drawing

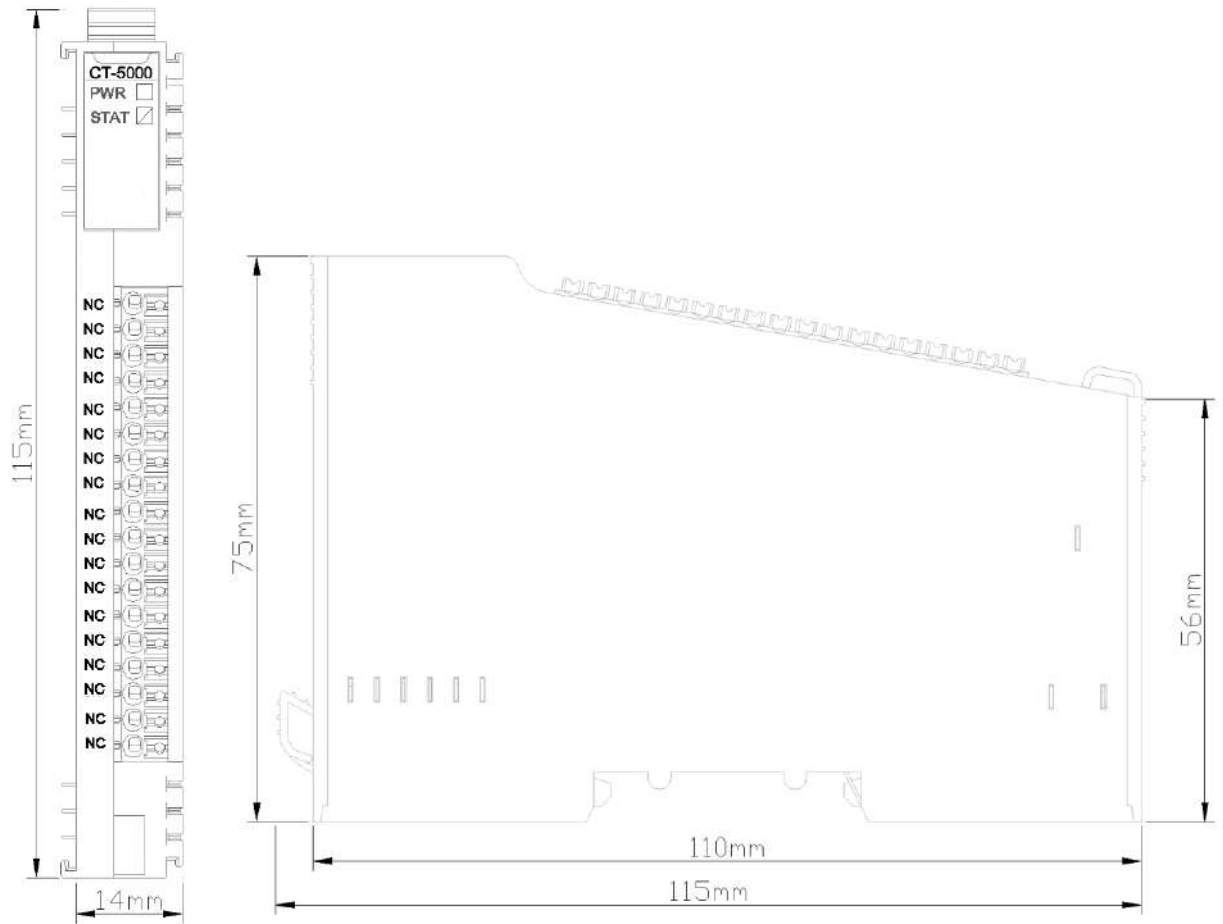

CT-5102 2-channels encoder input /5VDC

1 Module features

- ◆ The module supports two channels of encoder input.
- ◆ Each encoder channel supports A/B incremental encoder or pulse-directional encoder input.
- ◆ Each encoder channel supports orthogonal A/B signal input, input voltage 5V, and it supports source and sink input.
- ◆ The incremental encoder mode supports x1/ x2 / x4 frequency multiplication to be selectable.
- ◆ The pulse - direction mode supports nondirectional signal, pulse input only.
- ◆ Each encoder channel supports 1 digital input signal with an input voltage of 5Vdc or 24Vdc.
- ◆ Each encoder channel supports 1 digital output signal with an output voltage of 5Vdc.
- ◆ Each encoder channel supports 1 way of 5V power output, which can be connected to the encoder for power supply.
- ◆ The module internal bus and field input adopt magnetic isolation.
- ◆ The module carries 16 LED indicators.
- ◆ The maximum input frequency of the encoder supported by the module is 1.5MHz.
- ◆ The module supports measurement function; it could detect the load speed or input signal frequency.

2 Technical parameters

General Parameters	
Power	Max.65mA@5.0Vdc
Isolation	I/O to internal bus: magnetic isolation (3KVrms)
Field Power	Nominal:24Vdc, Range:20.4-28.8Vdc
Wiring	Max.: AWG 18
Mounting Type	35mm DIN-Rail
Size	115*14*75mm
Weight	65g
Environment Specification	
Operating Temperature of Horizontal Installation	-35°C~70°C
Operating Temperature of Vertical Installation	-35°C~60°C
Relative Humidity	< 95%RH (No Condensation)
Storage Temperature	-40°C~85°C
Storage Humidity	< 95%RH (No Condensation)
Manufacturing Test Temperature	-40°C~75°C
Ingress Protection Rating	IP20
Input Parameters	
Channel Number	2-channel encoder
LED Indicator	16 channel input LED indicator
Encoder Signal Voltage Range	ABZ input standard 5Vdc, range $\pm 10\%$
Encoder Input Impedance	Internal pull-up or pull-down resistance 4.7K
Encoder Filtering Time	Could be set, the default value is 0.5 us
Encoder Count Frequency	<1.5MHz
Encoder Frequency Multiplication Mode	x1/x2/x4
Encoder Measurement Function	Load speed or input signal frequency measurement
DI Turn-on Voltage	Min.5Vdc to Max.28Vdc
DI Turn-off Voltage	Max.2.7Vdc
DI Turn-on Current	Max.5mA/channel@28V
DI Input Impedance	>10.0k Ω
DI Input Delay	OFF to ON: Max.3ms ON to OFF: Max.2ms
DO Output Voltage	24V, range $\pm 10\%$
DO Output Current	Max.500mA
DO Output Sink Current	Max.5uA

 **WARNING**

UNEXPECTED EQUIPMENT OPERATION

Do not exceed any of the ratings specified in the environmental and electrical characteristics table.

Failure to follow instructions specified by the manufacturer may result in serious consequences such as death, personal injury, or damage to equipment since the protection provided by the equipment may be impaired.

 **AVERTISSEMENT**

FONCTIONNEMENT INATTENDU DE L'EQUIPEMENT

Ne dépassez aucune évaluation spécifiée dans le tableau de caractéristiques environnementales et électriques..

Le fait de ne pas suivre les instructions peut entraîner une défaillance de la protection fournie par l'équipement, ce qui peut entraîner des conséquences graves, comme des blessures ou des dommages à l'équipement.

3 Hardware interfaces

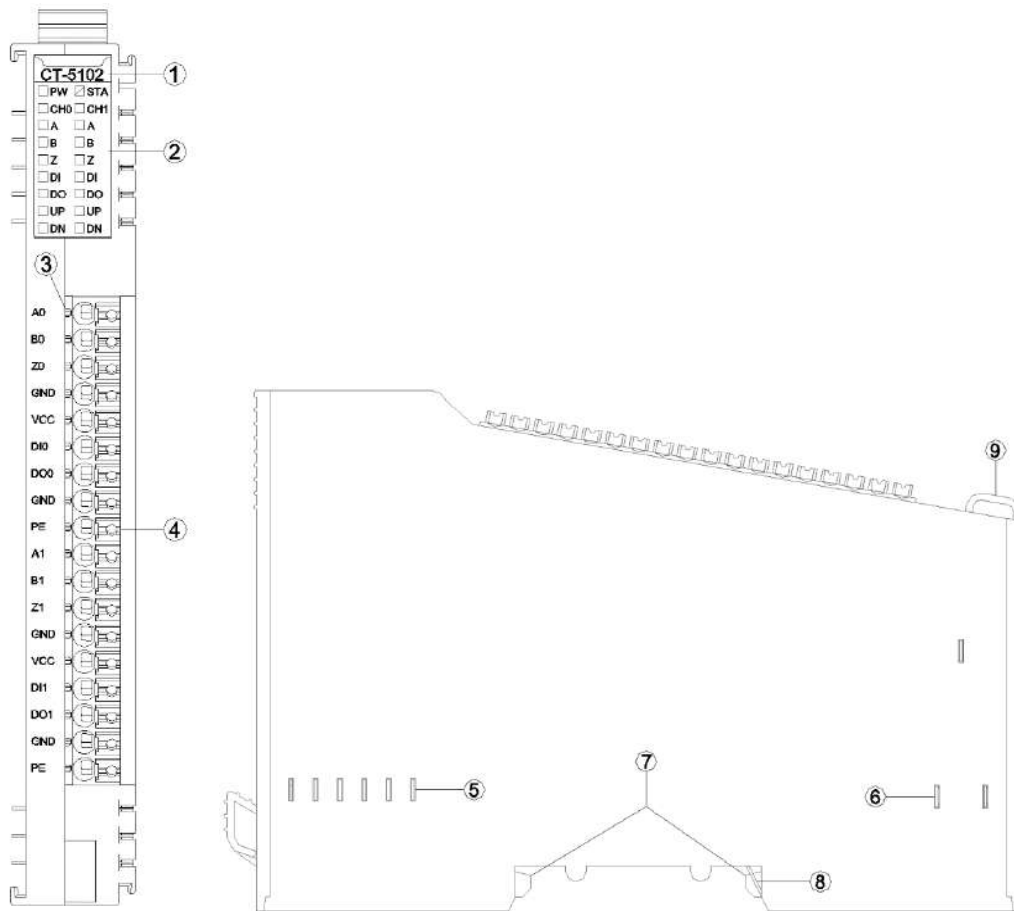

- ① Module Type
- ② State indicator
- ③ Channel indicator
- ④ Wiring Terminal and identification
- ⑤ Internal Bus
- ⑥ Field Power
- ⑦ Buckle
- ⑧ Grounding Spring Sheet
- ⑨ Fixed Wiring Harness

3.1 LED indicator definition

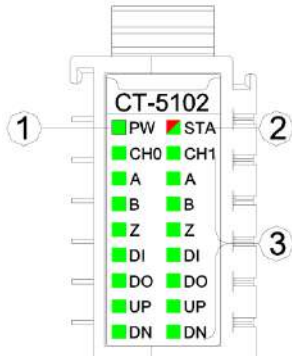

- ① Power LED indicator (green)
- ② Module State indicator LED (red/green)
- ③ Input channel indicator LED (green)

PW Power State	Definition
ON	Internal bus power supply normal
OFF	Internal bus power supply failure
STA Module State	Definition
Green slow flash (2.5 Hz)	Module internal bus is not started
Red slow flash (2.5 Hz)	Module internal bus offline
ON (GREEN)	Operation normal
Flash (2.5 Hz) (RED/GREEN)	updating mode
Flash (10 Hz) (RED/GREEN)	firmware update
Double Flash (RED)	Module exception has been soft-restarted
CH0 CH1 channel indicator LED	Definition
ON	Channel enable
A B Z Encoder signal indicator	Definition
ON	Input signal valid
OFF	Input signal invalid
DI input indicator	Definition
ON	Input signal high level
OFF	Input signal invalid
DO output indicator	Definition
ON	Output signal high level
OFF	Output signal invalid
UP indicator	Definition
ON	Encoder in positive rotation
OFF	Encoder is stationary or in contrarotation
DN indicator	Definition
ON	Encoder in contrarotation
OFF	Encoder is stationary or in positive rotation

WARNING

UNEXPECTED EQUIPMENT OPERATION

By viewing the PW indicator, could determine the power supply status of a module. If the PW is steady green, the power supply is normal. Otherwise, the module cannot work properly.

When the module is initially powered on, there will be 3S for the backplane bus connection. After the backplane bus is initialized, STA is in the green steady state. If STA is in the green blinking state, it indicates that the backplane bus has not been initialized, and it needs to be powered off and restarted for re-initialization.

STA abnormal working state occurs during the normal operation of the module, please check the firmware version information of all modules, and consult ODOT technical support for details.

If a module is upgraded, check that all modules are in the normal state after the upgrade. Otherwise, an exception may occur.

Failure to follow instructions specified by the manufacturer may result in serious consequences such as death, personal injury, or damage to equipment since the protection provided by the equipment may be impaired.

AVERTISSEMENT

FONCTIONNEMENT INATTENDU DE L'EQUIPEMENT

En regardant l'état de l'indicateur de PW, jugez l'état d'alimentation du module. Le feu vert PW reste allumé et l'alimentation est normale. Autrement, le module ne fonctionnera pas correctement.

Lorsque le module est alimenté initialement, il y aura 3S pour la connexion de bus de backboard. STA est un état vert permanent après l'initialisation du bus de backboard. Si STA est en état de clignotement vert, cela signifie que l'initialisation du bus de backboard n'est pas passée et doit être redémarrée hors tension et réinitialisée.

L'état de fonctionnement anormal de STA se produit pendant le fonctionnement normal du module, veuillez vérifier les informations de version du firmware de tous les modules, et consulter le support technique ODOT pour plus de détails.

Si le module a une opération de mise à niveau, après l'achèvement de la mise à niveau, le besoin de vérifier que tous les modules sont dans l'état normal avant de courir, sinon il conduira à une exception.

Le fait de ne pas suivre les instructions peut entraîner une défaillance de la protection fournie par l'équipement, ce qui peut entraîner des conséquences graves, comme des blessures ou des dommages à l'équipement.

3.2 Field channel LED indicator (Green)

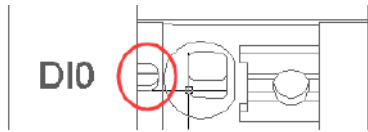

When the input signal of the input channel is valid, the corresponding field channel indicator is on (only the DI/DO/VCC wiring terminal of the encoder channel carries the indicator).

3.3 Terminal definition

Terminal Number	Symbol	Description
1	A0	CH0 encoder phase A input
2	B0	CH0 encoder phase B input
3	Z0	CH0 encoder phase Z input
4	GND	Signal ground
5	VCC	5V power output
6	DI0	CH0 digital signal input
7	DO0	CH0 digital signal output
8	GND	Signal ground
9	PE	Shield earthing
10	A1	CH1 encoder phase A input
11	B1	CH1 encoder phase B input
12	Z1	CH1 encoder phase Z input
13	GND	Signal ground
14	VCC	5V power output
15	DI1	CH1 digital signal input
16	DO1	CH1 digital signal output
17	GND	Signal ground
18	PE	Shield earthing

⚠ WARNING

UNEXPECTED EQUIPMENT OPERATION

Calculate the maximum field power current consumption of a single module based on the actual field load. If the total field power current consumption of all I/O modules exceeds the power supply capacity of the field power supply, you must add an extra power expansion module. Otherwise, an output channel exception may occur.

Failure to follow instructions specified by the manufacturer may result in serious consequences such as death, personal injury, or damage to equipment since the protection provided by the equipment may be impaired.

⚠️ AVERTISSEMENT

FONCTIONNEMENT INATTENDU DE L'EQUIPEMENT

Calculez la consommation maximale de courant de champ d'un seul module en fonction de la charge de champ réelle. Si la consommation totale de courant de champ de tous les modules d'E/S dépasse la capacité d'alimentation de l'alimentation de champ, vous devez ajouter un module d'extension de puissance supplémentaire. Dans le cas contraire, une exception de canal de sortie peut se produire.

Le fait de ne pas suivre les instructions peut entraîner une défaillance de la protection fournie par l'équipement, ce qui peut entraîner des conséquences graves, comme des blessures ou des dommages à l'équipement.

When connecting a cold-pressed terminal, the terminal must be terminated and checked in strict accordance with the corresponding termination specifications or requirements, and connect the cold-pressed terminal according to the corresponding node serial number. The conductor should use copper conductor and the conductor core should be larger than 0.2mm^2 and smaller than 1mm^2 (AWG18~AWG24). Cold-pressed terminal parameters are as follows:

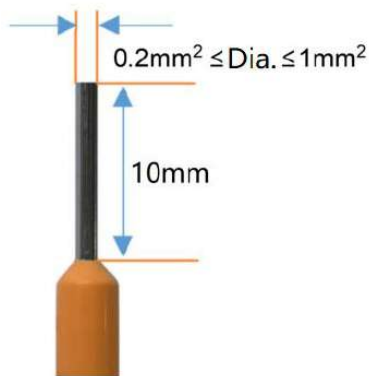

⚠️ WARNING

UNEXPECTED EQUIPMENT OPERATION

Strip the length of the conductor insulation layer is greater than 10mm to ensure reliable signal connection.

The wire needs to use copper wire and the wire core is greater than or equal to 0.2mm^2 and less than or equal to 1mm^2 to ensure reliable signal connection.

When connecting a cold-press terminal, connect the cold-press terminal strictly in accordance with the corresponding termination specifications or requirements, and connect the cold-press terminal according to the corresponding node serial number.

Do not power on cold-press terminals until they are properly connected or fully locked.

Failure to follow instructions specified by the manufacturer may result in serious consequences such as death, personal injury, or damage to equipment since the protection provided by the equipment may be impaired.

AVERTISSEMENT

FONCTIONNEMENT INATTENDU DE L'EQUIPEMENT

Dépouillez la longueur de la couche isolante du fil plus de 10mm pour assurer la connexion fiable du signal.

Le conducteur doit utiliser le fil de cuivre et le noyau de fil est supérieur ou égal à 0,2 mm², inférieur ou égal à 1mm², afin d'assurer la connexion fiable du signal.

Lorsque les terminaux de presse à froid sont terminés, ils doivent être terminés et visualisés en stricte conformité avec les spécifications ou les exigences correspondantes et terminés selon le numéro de série de noeud correspondant.

Il est interdit d'activer les bornes à froid avant qu'elles ne soient correctement articulées ou complètement verrouillées.

Le fait de ne pas suivre les instructions peut entraîner une défaillance de la protection fournie par l'équipement, ce qui peut entraîner des conséquences graves, comme des blessures ou des dommages à l'équipement.

DANGER

FIRE DANGER

Use the correct wiring rules only for the maximum current capacity of the I/O channel and power supply.

Failure to follow instructions specified by the manufacturer may result in serious consequences such as death, personal injury, or damage to equipment since the protection provided by the equipment may be impaired.

WARNING

UNEXPECTED EQUIPMENT OPERATION

Do not exceed any of the ratings specified in the environmental and electrical characteristics table.

Failure to follow instructions specified by the manufacturer may result in serious consequences such as death, personal injury, or damage to equipment since the protection provided by the equipment may be impaired.

AVERTISSEMENT

FONCTIONNEMENT INATTENDU DE L'EQUIPEMENT

Ne dépassez aucune évaluation spécifiée dans le tableau de caractéristiques environnementales et électriques..

Le fait de ne pas suivre les instructions peut entraîner une défaillance de la protection fournie par l'équipement, ce qui peut entraîner des conséquences graves, comme des blessures ou des dommages à l'équipement.

4 Wiring

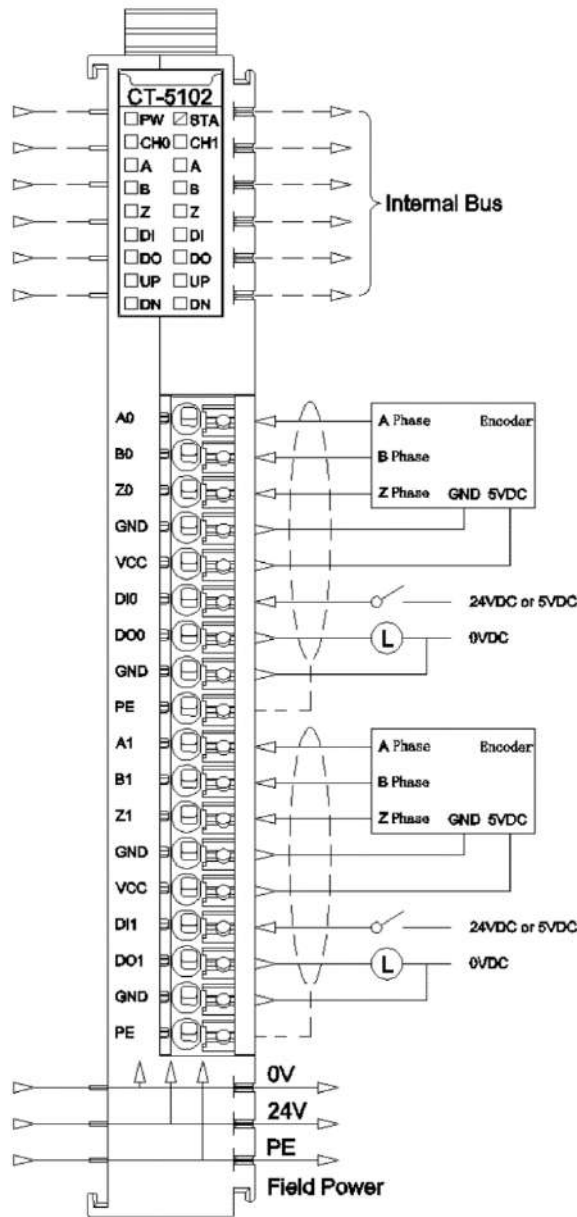

NOTICE

EQUIPMENT INOPERABLE

Do not crimp the spring terminal with more than the maximum pressure specified for the terminal. Otherwise, the resilience of the spring terminal may be damaged and the terminal rebound may be affected.

Do not press the spring terminal with a sharp tool when removing cable from the channel. Otherwise, the spring terminal will be damaged.

Failure to follow these instructions may result in equipment damage.

5 Process data definition

< 2 Analog Input (5V Encoder) > Submodule process data definition

Input Data								
Bit No	Bit 7	Bit 6	Bit 5	Bit 4	Bit 3	Bit 2	Bit 1	Bit 0
Byte 0	Counter DOWN Ch#0	Counter UP Ch#0	Counter Underflow Ch#0	Counter Overflow Ch#0	DI Ch#0	Z Ch#0	B Ch#0	A Ch#0
Byte 1	Reserved							
Byte 2	Counter DOWN Ch#1	Counter UP Ch#1	Counter Underflow Ch#1	Counter Overflow Ch#1	DI Ch#1	Z Ch#1	B Ch#1	A Ch#1
Byte 3	Reserved							
Byte 4	Counter value Ch#0							
Byte 5								
Byte 6								
Byte 7								
Byte 8	Capture value Ch#0							
Byte 9								
Byte 10								
Byte 11								
Byte 12	Measurements 1 Ch#0							
Byte 13								
Byte 14								
Byte 15								
Byte 16	Measurements 2 Ch#0							
Byte 17								
Byte 18								
Byte 19								
Byte 20	Counter value Ch#1							
Byte 21								
Byte 22								
Byte 23								
Byte 24	Capture value Ch#1							
Byte 25								
Byte 26								
Byte 27								
Byte 28	Measurements 1 Ch#1							
Byte 29								
Byte 30								
Byte 31								
Byte 32	Measurements 2 Ch#1							
Byte 33								
Byte 34								
Byte 35								
Output Data								
Bit No	Bit 7	Bit 6	Bit 5	Bit 4	Bit 3	Bit 2	Bit 1	Bit 0

Byte 0	Reserved	Counter Control Ch#0	Flow Clear Ch#0	Counter Set Trigger Ch#0	DO Ch#0
Byte 1	Reserved				
Byte 2	Reserved	Counter Control Ch#1	Flow Clear Ch#1	Counter Set Trigger Ch#1	DO Ch#1
Byte 3	Reserved				
Byte 4	Set Value for Counter Ch#0				
Byte 5					
Byte 6					
Byte 7					
Byte 8	Set Value for Counter Ch#1				
Byte 9					
Byte 10					
Byte 11					

Data description:

Input data definition:

A/B/Z Ch#(0-1): The position is 1 when the corresponding channel A/B/Z input signal is valid, and 0 when the input is invalid.

DI Ch#(0-1): Digital input signal status.

Counter Overflow Ch#(0-1): Counter overflowed flag bit.

Counter Underflow Ch#(0-1): Counter underflows flag bit.

Counter UP: Encoder positive rotation, counter up counting sign.

Counter DOWN: Encoder contrarotation, counter down count flag.

Counter Value Ch#(0-1): Pulse count value, 32 - bit signed integer, automatically clear after overflow.

Capture value Ch#(0-1): Pulse capture value, 32-bit signed integer, and when DI is set to capture, the pulse count value will be captured to the capture value at the selected edge.

Measurements 1 Ch#(0-1): Measurement value 1, the measurement value will be output according to the measurement value type selected by the user (view the configuration parameter section of the module for optional measurement value)

Measurements 2 Ch#(0-1): Measurement value 2, the measurement value will be

output according to the measurement value type selected by the user (view the configuration parameter section of the module for optional measurement value)

Output data definition:

DO Ch#(0-1): Digital output channel control.

Counter Set Trigger CH#(0-1): Counter set trigger bit, rising edge trigger counter set, the output value **Set Value for Counter** will be updated to **Counter Value**, this function can be used to set the initial value of the counter.

Flow Clear CH#(0-1): Overflow clear bit, the rising edge can clear the input **Counter**

Overflow and **Counter Underflow** flag bits.

Set Value for Counter Ch#(0-1): Counter set value.

6 Configuration parameters definition

<2 Analog Input (5V Encoder)> Submodule configuration parameter definition

Configuration Parameter								
Bit No	Bit 7	Bit 6	Bit 5	Bit 4	Bit 3	Bit 2	Bit 1	Bit 0
Byte 0	Reserved					16Bit Data Format	32Bit Data Format	
Byte 1	Reserved				Counter Control Ch#0	Work Mode Ch#0		
Byte 2	Reserved						Frequency Multiplication Ch#0	
Byte 3	Reserved		Filtering Prescaler Ch#0	Filtering Time Ch#0				
Byte 4	Reserved						Counter Storage Ch#0	
Byte 5	Reserved						Encode Output Signal Type Ch#0	
Byte 6	Reserved						DI Function Selection Ch#0	
Byte 7	Reserved						Capture Mode Ch#0	
Byte 8 ... Byte 17	Reserved							
Byte 18	Reserved					Speed Measurement Time Ch#0		
Byte 19	Reserved		Measurements 2 Type Ch#0			Measurements 1 Type Ch#0		
Byte 20	Encoder Resolution Ch#0							
Byte 21								
Byte 22	Transmission Ratio Active Ch#0							
Byte 23								
Byte 24	Transmission Ratio Slave Ch#0							
Byte 25								
Byte 26 ... Byte 33	Reserved							
Byte 34	Reserved					Work Mode Ch#1		
Byte 35	Reserved						Frequency Multiplication Ch#1	
Byte 36	Reserved			Filtering Time Ch#1				

Byte 37	Reserved		Counter Storage Ch#1
Byte 38	Reserved		Encode Output Signal Type Ch#1
Byte 39	Reserved		DI Function Selection Ch#1
Byte 40	Reserved		Capture Mode Ch#1
Byte 41 ... Byte 50	Reserved		
Byte 51	Reserved		Speed Measurement Time Ch#1
Byte 52	Reserved	Measurements 2 Type Ch#1	Measurements 1 Type Ch#1
Byte 53	Encoder Resolution Ch#1		
Byte 54			
Byte 55	Transmission Ratio Active Ch#1		
Byte 56			
Byte 57	Transmission Ratio Slave Ch#1		
Byte 58			
Byte 59 ... Byte 66	Reserved		

Data description:

16Bit Data Format: Byte transfer order of channel state. (Default: 0)

- 0: A-B
- 1: B-A

32Bit Data Format: The byte transfer order of a channel count value. (Default: 0)

- 0: AB-CD
- 1: BA-DC
- 2: CD-AB
- 3: DC-BA

Work Mode Ch#(0-1): Working mode of encoder. (Default: 0)

- 0: Incremental encoder mode.
- 1: Count direction mode.
- 2: Count up mode.

3: Count down mode.

Frequency Multiplication Ch#(0-1): Frequency multiplication number (available only in incremental encoder mode), according to this mode it could output pulse count value. (Default: 2)

0: frequency multiplication 1

1: frequency multiplication 2

2: frequency multiplication 4

Filtering Time Ch#(0-1): Encoder input filter time (default: 5)

0: no filter

1: 0.1uS

...

5: 0.5 uS

...

31: 3.1 uS

Counter Storage Ch#(0-1): Enable storage. When the storage function is enabled, the IO module will save the count value to the non-volatile memory in real time, and load the last saved count value at the next power-on. (Default: 1)

0: Disable

1: Enable

Encoder Output Signal Type Ch#(0-1): Encoder output type (default: 0)

0: Source

1: Sink

2: Push-pull

DI Function Selection Ch#(0-1): DI function selection (Default: 0)

0: Normal DI function

1: Pulse capture function

Capture Mode Ch#(0-1): Capture mode (default: 0)

0: Rising edge capture

1: Falling edge capture

2: Double edge capture

Speed Measurement Time Ch#(0-1): Speed measurement period (Default: 6)

0: 10mS

1: 20mS

2: 50mS

3: 100mS

4: 200mS

5: 500mS

6: 1000mS

7: 2000mS

Measurements 1 Type Ch#(0-1): Measurement value 1 Type selection (default: 0)

0: No measurements

1: Measuring speed (min/rotation)

2: Measuring frequency

Measurements 2 Type Ch#(0-1): Measurement value 2 Type selection (default: 0)

0: No measurements

1: Measuring speed (min/ rotation)

2: Measuring frequency

Encoder Resolution Ch#(0-1): Encoder resolution (default: 1)

Value range: 1-65535

Transmission Ratio Active Ch#(0-1): 1) Transmission ratio (main) (Default: 1)

Value range: 1-65535

Transmission Ratio Slave Ch#(0-1): Transmission ratio (main) (Default: 1)

Value range: 1-65535

A Dimension drawing

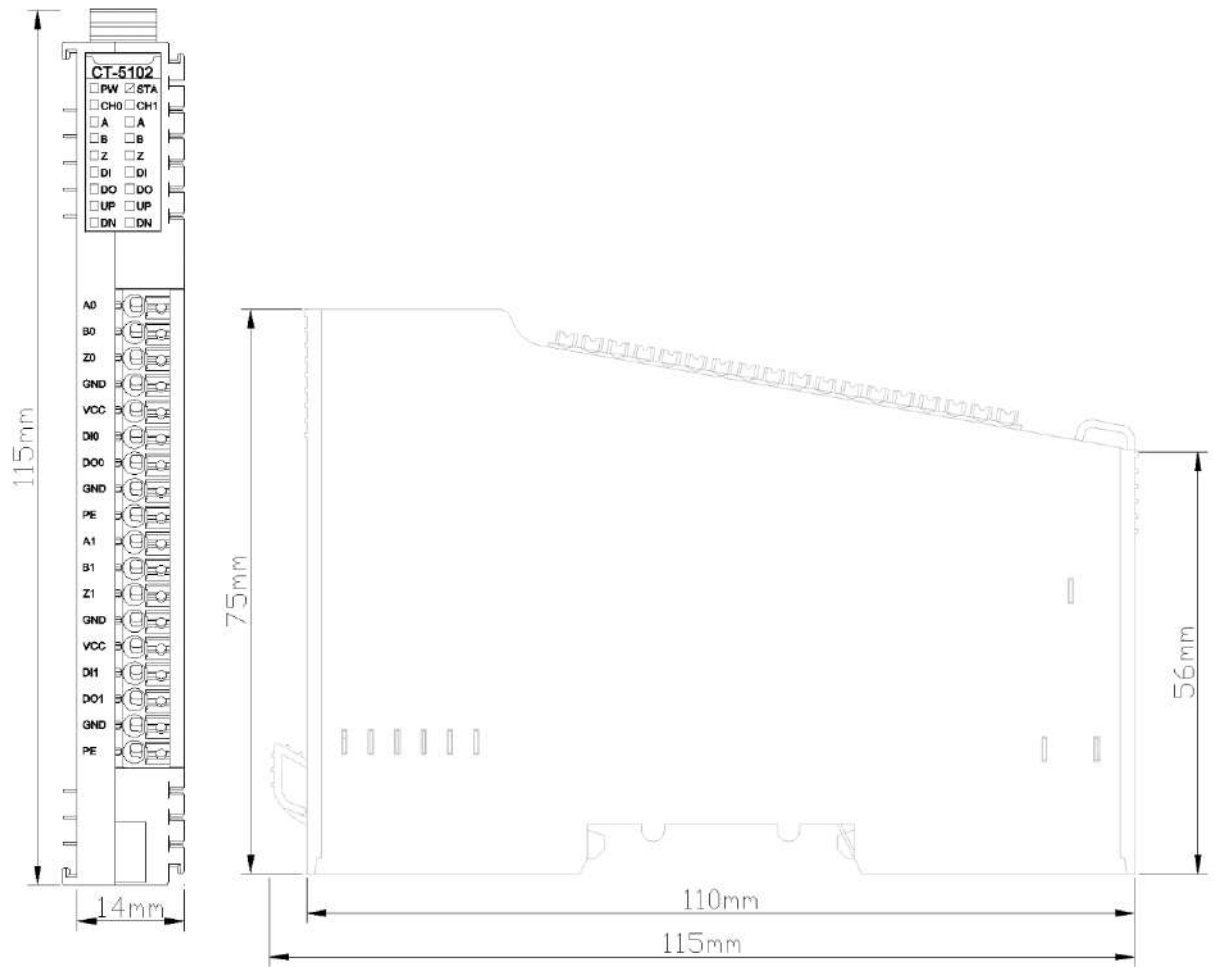

CT-5112 2-channels encoder input/24VDC

1 Module features

- ◆ The module supports two channels of encoder input.
- ◆ Each encoder channel supports A/B incremental encoder or pulse-directional encoder input.
- ◆ Each encoder channel supports orthogonal A/B signal input, input voltage 24V, and it supports source and sink input.
- ◆ The incremental encoder mode supports x1/ x2 / x4 frequency multiplication mode.
- ◆ The pulse - direction mode supports nondirectional signal, pulse input only.
- ◆ Each encoder channel supports 1 digital input signal with an input voltage of 5Vdc or 24Vdc.
- ◆ Each encoder channel supports 1 digital output signal with an output voltage of 24Vdc.
- ◆ Each encoder channel supports 1 way of 24V power output, which can be connected to the encoder for power supply.
- ◆ The module internal bus and field input adopt magnetic isolation.
- ◆ The module carries 16 LED indicators.
- ◆ The maximum input frequency of the encoder supported by the module is 0.5MHz.
- ◆ The module supports measurement function; it could detect the load speed or input signal frequency.

2 Technical parameters

General Parameters	
Power	Max.65mA@5.0Vdc
Isolation	I/O to internal bus: magnetic isolation (3KVrms)
Field Power	Nominal:24Vdc, Range:20.4-28.8Vdc
Wiring	Max.: AWG 18
Mounting Type	35mm DIN-Rail
Size	115*14*75mm
Weight	65g
Environment Specification	
Operating Temperature of Horizontal Installation	-35°C~70°C
Operating Temperature of Vertical Installation	-35°C~60°C
Relative Humidity	< 95%RH (No Condensation)
Storage Temperature	-40°C~85°C
Storage Humidity	< 95%RH (No Condensation)
Manufacturing Test Temperature	-40°C~75°C
Ingress Protection Rating	IP20
Input Parameters	
Channel Number	2-channel encoder
LED Indicator	16 channel input LED indicator
Encoder ABZ Signal Range	Logical "0": 0 - 6Vdc Logical "1": 20.4 – 28.8Vdc
Encoder Input Impedance	Internal pull-up or pull-down resistance 4.7K
Encoder Filtering Time	Could be set, the default value is 0.5 us
Encoder Count Frequency	<0.5MHz
Encoder Frequency Multiplication Mode	x1/x2/x4
Encoder Measurement Function	Load speed or input signal frequency measurement
DI Turn-on Voltage	Min.5Vdc to Max.28Vdc
DI Turn-off Voltage	Max.2.7Vdc
DI Turn-on Current	Max.5mA/channel@28V
DI Input Impedance	>10.0kΩ
DI Input Delay	OFF to ON: Max.3ms ON to OFF: Max.2ms
DO Output Voltage	24V, range ±10%
DO Output Current	Max.500mA
DO Output Sink Current	Max.5uA

 **WARNING**

UNEXPECTED EQUIPMENT OPERATION

Do not exceed any of the ratings specified in the environmental and electrical characteristics table.

Failure to follow instructions specified by the manufacturer may result in serious consequences such as death, personal injury, or damage to equipment since the protection provided by the equipment may be impaired.

 **AVERTISSEMENT**

FONCTIONNEMENT INATTENDU DE L'EQUIPEMENT

Ne dépassez aucune évaluation spécifiée dans le tableau de caractéristiques environnementales et électriques..

Le fait de ne pas suivre les instructions peut entraîner une défaillance de la protection fournie par l'équipement, ce qui peut entraîner des conséquences graves, comme des blessures ou des dommages à l'équipement.

3 Hardware interfaces

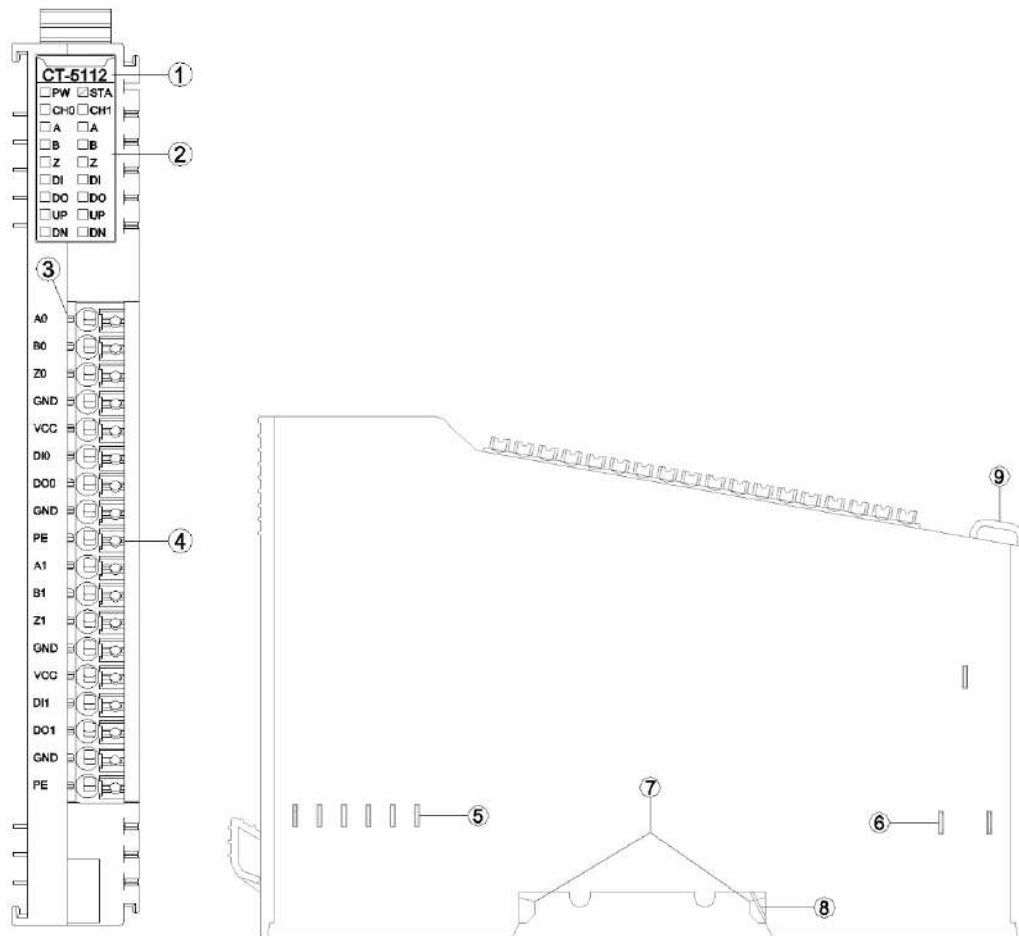

- ① Module Type
- ② State indicator
- ③ Channel indicator
- ④ Wiring Terminal and identification
- ⑤ Internal Bus
- ⑥ Field Power
- ⑦ Buckle
- ⑧ Grounding Spring Sheet
- ⑩ Fixed Wiring Harness

3.1 LED indicator definition

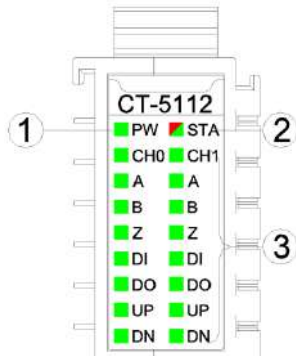

- ① Power LED indicator (green)
- ② Module State indicator LED (red/green)
- ③ Input channel indicator LED (green)

PW Power State	Definition
ON	Internal bus power supply normal
OFF	Internal bus power supply failure
STA Module State	Definition
Green slow flash (2.5 Hz)	Module internal bus is not started
Red slow flash (2.5 Hz)	Module internal bus offline
ON (GREEN)	Operation normal
Flash (2.5 Hz) (RED/GREEN)	updating mode
Flash (10 Hz) (RED/GREEN)	firmware update
Double Flash (RED)	Module exception has been soft-restarted
CH0 CH1 channel indicator LED	Definition
ON	Channel enable
A B Z Encoder signal indicator	Definition
ON	Input signal valid
OFF	Input signal invalid
DI input indicator	Definition
ON	Input signal high level
OFF	Input signal invalid
DO output indicator	Definition
ON	Output signal high level
OFF	Output signal invalid
UP indicator	Definition
ON	Encoder in positive rotation
OFF	Encoder is stationary or in contrarotation
DN indicator	Definition
ON	Encoder in contrarotation
OFF	Encoder is stationary or in positive rotation

 **WARNING****UNEXPECTED EQUIPMENT OPERATION**

By viewing the PW indicator, could determine the power supply status of a module. If the PW is steady green, the power supply is normal. Otherwise, the module cannot work properly.

When the module is initially powered on, there will be 3S for the backplane bus connection. After the backplane bus is initialized, STA is in the green steady state. If STA is in the green blinking state, it indicates that the backplane bus has not been initialized, and it needs to be powered off and restarted for re-initialization.

STA abnormal working state occurs during the normal operation of the module, please check the firmware version information of all modules, and consult ODOT technical support for details.

If a module is upgraded, check that all modules are in the normal state after the upgrade. Otherwise, an exception may occur.

Failure to follow instructions specified by the manufacturer may result in serious consequences such as death, personal injury, or damage to equipment since the protection provided by the equipment may be impaired.

 **AVERTISSEMENT****FONCTIONNEMENT INATTENDU DE L'EQUIPEMENT**

En regardant l'état de l'indicateur de PW, jugez l'état d'alimentation du module. Le feu vert PW reste allumé et l'alimentation est normale. Autrement, le module ne fonctionnera pas correctement.

Lorsque le module est alimenté initialement, il y aura 3S pour la connexion de bus de backboard. STA est un état vert permanent après l'initialisation du bus de backboard. Si STA est en état de clignotement vert, cela signifie que l'initialisation du bus de backboard n'est pas passée et doit être redémarrée hors tension et réinitialisée.

L'état de fonctionnement anormal de STA se produit pendant le fonctionnement normal du module, veuillez vérifier les informations de version du firmware de tous les modules, et consulter le support technique ODOT pour plus de détails.

Si le module a une opération de mise à niveau, après l'achèvement de la mise à niveau, le besoin de vérifier que tous les modules sont dans l'état normal avant de courir, sinon il conduira à une exception.

Le fait de ne pas suivre les instructions peut entraîner une défaillance de la protection fournie par l'équipement, ce qui peut entraîner des conséquences graves, comme des blessures ou des dommages à l'équipement.

3.2 Field channel LED indicator (Green)

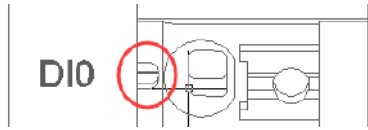

When the input signal of the input channel is valid, the corresponding field channel indicator is on (only the DI/DO/VCC wiring terminal of the encoder channel carries the indicator).

3.3 Terminal definition

Terminal Number	Symbol	Description
1	A0	CH0 encoder phase A input
2	B0	CH0 encoder phase B input
3	Z0	CH0 encoder phase Z input
4	GND	Signal ground
5	VCC	24V power output
6	DI0	CH0 digital signal input
7	DO0	CH0 digital signal output
8	GND	Signal ground
9	PE	Shield earthing
10	A1	CH1 encoder phase A input
11	B1	CH1 encoder phase B input
12	Z1	CH1 encoder phase Z input
13	GND	Signal ground
14	VCC	24V power output
15	DI1	CH1 digital signal input
16	DO1	CH1 digital signal output
17	GND	Signal ground
18	PE	Shield earthing

⚠ WARNING

UNEXPECTED EQUIPMENT OPERATION

Calculate the maximum field power current consumption of a single module based on the actual field load. If the total field power current consumption of all I/O modules exceeds the power supply capacity of the field power supply, you must add an extra power expansion module. Otherwise, an output channel exception may occur.

Failure to follow instructions specified by the manufacturer may result in serious consequences such as death, personal injury, or damage to equipment since the protection provided by the equipment may be impaired.

⚠️ AVERTISSEMENT

FONCTIONNEMENT INATTENDU DE L'EQUIPEMENT

Calculez la consommation maximale de courant de champ d'un seul module en fonction de la charge de champ réelle. Si la consommation totale de courant de champ de tous les modules d'E/S dépasse la capacité d'alimentation de l'alimentation de champ, vous devez ajouter un module d'extension de puissance supplémentaire. Dans le cas contraire, une exception de canal de sortie peut se produire.

Le fait de ne pas suivre les instructions peut entraîner une défaillance de la protection fournie par l'équipement, ce qui peut entraîner des conséquences graves, comme des blessures ou des dommages à l'équipement.

When connecting a cold-pressed terminal, the terminal must be terminated and checked in strict accordance with the corresponding termination specifications or requirements, and connect the cold-pressed terminal according to the corresponding node serial number. The conductor should use copper conductor and the conductor core should be larger than 0.2mm^2 and smaller than 1mm^2 (AWG18~AWG24). Cold-pressed terminal parameters are as follows:

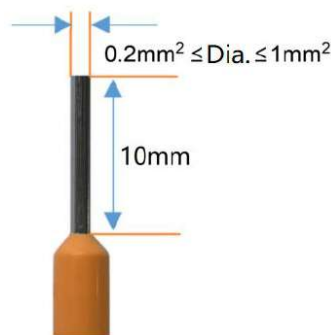

⚠️ WARNING

UNEXPECTED EQUIPMENT OPERATION

Strip the length of the conductor insulation layer is greater than 10mm to ensure reliable signal connection.

The wire needs to use copper wire and the wire core is greater than or equal to 0.2mm^2 and less than or equal to 1mm^2 to ensure reliable signal connection.

When connecting a cold-press terminal, connect the cold-press terminal strictly in accordance with the corresponding termination specifications or requirements, and connect the cold-press terminal according to the corresponding node serial number.

Do not power on cold-press terminals until they are properly connected or fully locked.

Failure to follow instructions specified by the manufacturer may result in serious

consequences such as death, personal injury, or damage to equipment since the protection provided by the equipment may be impaired.

AVERTISSEMENT

FONCTIONNEMENT INATTENDU DE L'EQUIPEMENT

Dépouillez la longueur de la couche isolante du fil plus de 10mm pour assurer la connexion fiable du signal.

Le conducteur doit utiliser le fil de cuivre et le noyau de fil est supérieur ou égal à 0,2 mm², inférieur ou égal à 1mm², afin d'assurer la connexion fiable du signal.

Lorsque les terminaux de presse à froid sont terminés, ils doivent être terminés et visualisés en stricte conformité avec les spécifications ou les exigences correspondantes et terminés selon le numéro de série de noeud correspondant.

Il est interdit d'activer les bornes à froid avant qu'elles ne soient correctement articulées ou complètement verrouillées.

Le fait de ne pas suivre les instructions peut entraîner une défaillance de la protection fournie par l'équipement, ce qui peut entraîner des conséquences graves, comme des blessures ou des dommages à l'équipement.

DANGER

FIRE DANGER

Use the correct wiring rules only for the maximum current capacity of the I/O channel and power supply.

Failure to follow instructions specified by the manufacturer may result in serious consequences such as death, personal injury, or damage to equipment since the protection provided by the equipment may be impaired.

WARNING

UNEXPECTED EQUIPMENT OPERATION

Do not exceed any of the ratings specified in the environmental and electrical characteristics table.

Failure to follow instructions specified by the manufacturer may result in serious consequences such as death, personal injury, or damage to equipment since the protection provided by the equipment may be impaired.

AVERTISSEMENT

FONCTIONNEMENT INATTENDU DE L'EQUIPEMENT

Ne dépassez aucune évaluation spécifiée dans le tableau de caractéristiques environnementales et électriques..

Le fait de ne pas suivre les instructions peut entraîner une défaillance de la protection fournie par l'équipement, ce qui peut entraîner des conséquences graves, comme des blessures ou des dommages à l'équipement.

4 Wiring

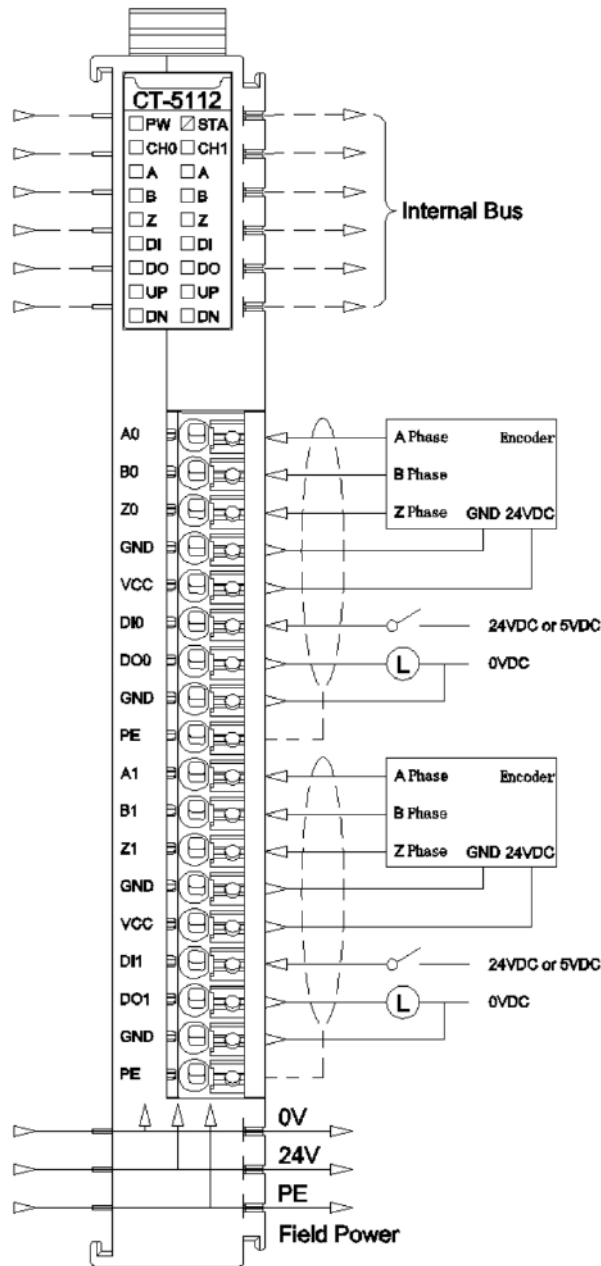

NOTICE

EQUIPMENT INOPERABLE

Do not crimp the spring terminal with more than the maximum pressure specified for the terminal. Otherwise, the resilience of the spring terminal may be damaged and the terminal rebound may be affected.

Do not press the spring terminal with a sharp tool when removing cable from the channel. Otherwise, the spring terminal will be damaged.

Failure to follow these instructions may result in equipment damage.

5 Process data definition

< 2 Analog Input(24V Encoder) > Submodule process data definition

Input Data								
Bit No	Bit 7	Bit 6	Bit 5	Bit 4	Bit 3	Bit 2	Bit 1	Bit 0
Byte 0	Counter DOWN Ch#0	Counter UP Ch#0	Counter Underflow Ch#0	Counter Overflow Ch#0	DI Ch#0	Z Ch#0	B Ch#0	A Ch#0
Byte 1	Reserved							
Byte 2	Counter DOWN Ch#1	Counter UP Ch#1	Counter Underflow Ch#1	Counter Overflow Ch#1	DI Ch#1	Z Ch#1	B Ch#1	A Ch#1
Byte 3	Reserved							
Byte 4	Counter value Ch#0							
Byte 5								
Byte 6								
Byte 7								
Byte 8	Capture value Ch#0							
Byte 9								
Byte 10								
Byte 11								
Byte 12	Measurements 1 Ch#0							
Byte 13								
Byte 14								
Byte 15								
Byte 16	Measurements 2 Ch#0							
Byte 17								
Byte 18								
Byte 19								
Byte 20	Counter value Ch#1							
Byte 21								
Byte 22								
Byte 23								
Byte 24	Capture value Ch#1							
Byte 25								
Byte 26								
Byte 27								
Byte 28	Measurements 1 Ch#1							
Byte 29								
Byte 30								
Byte 31								
Byte 32	Measurements 2 Ch#1							
Byte 33								
Byte 34								
Byte 35								
Output Data								
Bit No	Bit 7	Bit 6	Bit 5	Bit 4	Bit 3	Bit 2	Bit 1	Bit 0

Byte 0	Reserved	Flow Clear Ch#0	Counter Set Trigger Ch#0	DO Ch#0
Byte 1	Reserved			
Byte 2	Reserved	Flow Clear Ch#1	Counter Set Trigger Ch#1	DO Ch#1
Byte 3	Reserved			
Byte 4	Set Value for Counter Ch#0			
Byte 5				
Byte 6				
Byte 7				
Byte 8	Set Value for Counter Ch#1			
Byte 9				
Byte 10				
Byte 11				

Data description:

Input data definition:

A/B/Z Ch#(0-1): The position is 1 when the corresponding channel A/B/Z input signal is valid, and 0 when the input is invalid.

DI Ch#(0-1): Digital input signal status.

Counter Overflow Ch#(0-1): Counter overflowed flag bit.

Counter Underflow Ch#(0-1): Counter underflows flag bit.

Counter UP: Encoder positive rotation, counter up counting sign.

Counter DOWN: Encoder contrarotation, counter down count flag.

Counter Value Ch#(0-1): Pulse count value, 32 - bit signed integer, automatically clear after overflow.

Capture value Ch#(0-1): Pulse capture value, 32-bit signed integer, and when DI is set to capture, the pulse count value will be captured to the capture value at the selected edge.

Measurements 1 Ch#(0-1): Measurement value 1, the measurement value will be output according to the measurement value type selected by the user (view the configuration parameter section of the module for optional measurement value)

Measurements 2 Ch#(0-1): Measurement value 2, the measurement value will be

output according to the measurement value type selected by the user (view the configuration parameter section of the module for optional measurement value)

Output data definition:

DO Ch#(0-1): Digital output channel control.

Counter Set Trigger CH#(0-1): Counter set trigger bit, rising edge trigger counter set, the output value **Set Value for Counter** will be updated to **Counter Value**, this function can be used to set the initial value of the counter.

Flow Clear CH#(0-1): Overflow clear bit, the rising edge can clear the input **Counter**

Overflow and **Counter Underflow** flag bits.

Set Value for Counter Ch#(0-1): Counter set value.

6 Configuration parameters definition

<2 Analog Input (24V Encoder)> Submodule configuration parameter definition

Configuration Parameter								
Bit No	Bit 7	Bit 6	Bit 5	Bit 4	Bit 3	Bit 2	Bit 1	Bit 0
Byte 0	Reserved					16Bit Data Format	32Bit Data Format	
Byte 1	Reserved					Work Mode Ch#0		
Byte 2	Reserved					Frequency Multiplication Ch#0		
Byte 3	Reserved		Filtering Time Ch#0					
Byte 4	Reserved						Counter Storage Ch#0	
Byte 5	Reserved					Encode Output Signal Type Ch#0		
Byte 6	Reserved						DI Function Selection Ch#0	
Byte 7	Reserved					Capture Mode Ch#0		
Byte 8 ... Byte 17	Reserved							
Byte 18	Reserved					Speed Measurement Time Ch#0		
Byte 19	Reserved	Measurements 2 Type Ch#0			Measurements 1 Type Ch#0			
Byte 20	Encoder Resolution Ch#0							
Byte 21	Encoder Resolution Ch#0							
Byte 22	Transmission Ratio Active Ch#0							
Byte 23	Transmission Ratio Active Ch#0							
Byte 24	Transmission Ratio Slave Ch#0							
Byte 25	Transmission Ratio Slave Ch#0							
Byte 26 ... Byte 33	Reserved							
Byte 34	Reserved					Work Mode Ch#1		
Byte 35	Reserved					Frequency Multiplication Ch#1		
Byte 36	Reserved		Filtering Time Ch#1					
Byte 37	Reserved						Counter Storage Ch#1	
Byte 38	Reserved					Encode Output Signal Type Ch#1		

Byte 39	Reserved		DI Function Selection Ch#1
Byte 40	Reserved		Capture Mode Ch#1
Byte 41 ... Byte 50	Reserved		
Byte 51	Reserved		Speed Measurement Time Ch#1
Byte 52	Reserved	Measurements 2 Type Ch#1	Measurements 1 Type Ch#1
Byte 53	Encoder Resolution Ch#1		
Byte 54			
Byte 55	Transmission Ratio Active Ch#1		
Byte 56			
Byte 57	Transmission Ratio Slave Ch#1		
Byte 58			
Byte 59 ... Byte 66	Reserved		

Data description:

16Bit Data Format: Byte transfer order of channel state. (Default: 0)

0: A-B

1: B-A

32Bit Data Format: The byte transfer order of a channel count value. (Default: 0)

0: AB-CD

1: BA-DC

2: CD-AB

3: DC-BA

Work Mode Ch#(0-1): Working mode of encoder. (Default: 0)

0: Incremental encoder mode.

1: Count direction mode.

2: Count up mode.

3: Count down mode.

Frequency Multiplication Ch#(0-1): Frequency multiplication number (available only in incremental encoder mode), according to this mode it could output pulse count

value. (Default: 2)

- 0: frequency multiplication 1
- 1: frequency multiplication 2
- 2: frequency multiplication 4

Filtering Time Ch#(0-1): Encoder input filter time (default: 5)

- 0: no filter
- 1: 0.1uS
- ...
- 5: 0.5 uS
- ...
- 31: 3.1 uS

Counter Storage Ch#(0-1): Enable storage. When the storage function is enabled, the IO module will save the count value to the non-volatile memory in real time, and load the last saved count value at the next power-on. (Default: 1)

- 0: Disable
- 1: Enable

Encoder Output Signal Type Ch#(0-1): Encoder output type (default: 0)

- 0: Source
- 1: Sink
- 2: Push-pull

DI Function Selection Ch#(0-1): DI function selection (Default: 0)

- 0: Normal DI function
- 1: Pulse capture function

Capture Mode Ch#(0-1): Capture mode (default: 0)

- 0: Rising edge capture
- 1: Falling edge capture
- 2: Double edge capture

Speed Measurement Time Ch#(0-1): Speed measurement period (Default: 6)

- 0: 10mS
- 1: 20mS
- 2: 50mS
- 3: 100mS
- 4: 200mS
- 5: 500mS
- 6: 1000mS
- 7: 2000mS

Measurements 1 Type Ch#(0-1): Measurement value 1 Type selection (default: 0)

- 0: No measurements
- 1: Measuring speed (min/rotation)
- 2: Measuring frequency

Measurements 2 Type Ch#(0-1): Measurement value 2 Type selection (default: 0)

- 0: No measurements
- 1: Measuring speed (min/ rotation)
- 2: Measuring frequency

Encoder Resolution Ch#(0-1): Encoder resolution (default: 1)

Value range: 1-65535

Transmission Ratio Active Ch#(0-1): 1) Transmission ratio (main) (Default: 1)

Value range: 1-65535

Transmission Ratio Slave Ch#(0-1): Transmission ratio (main) (Default: 1)

Value range: 1-65535

A Dimension drawing

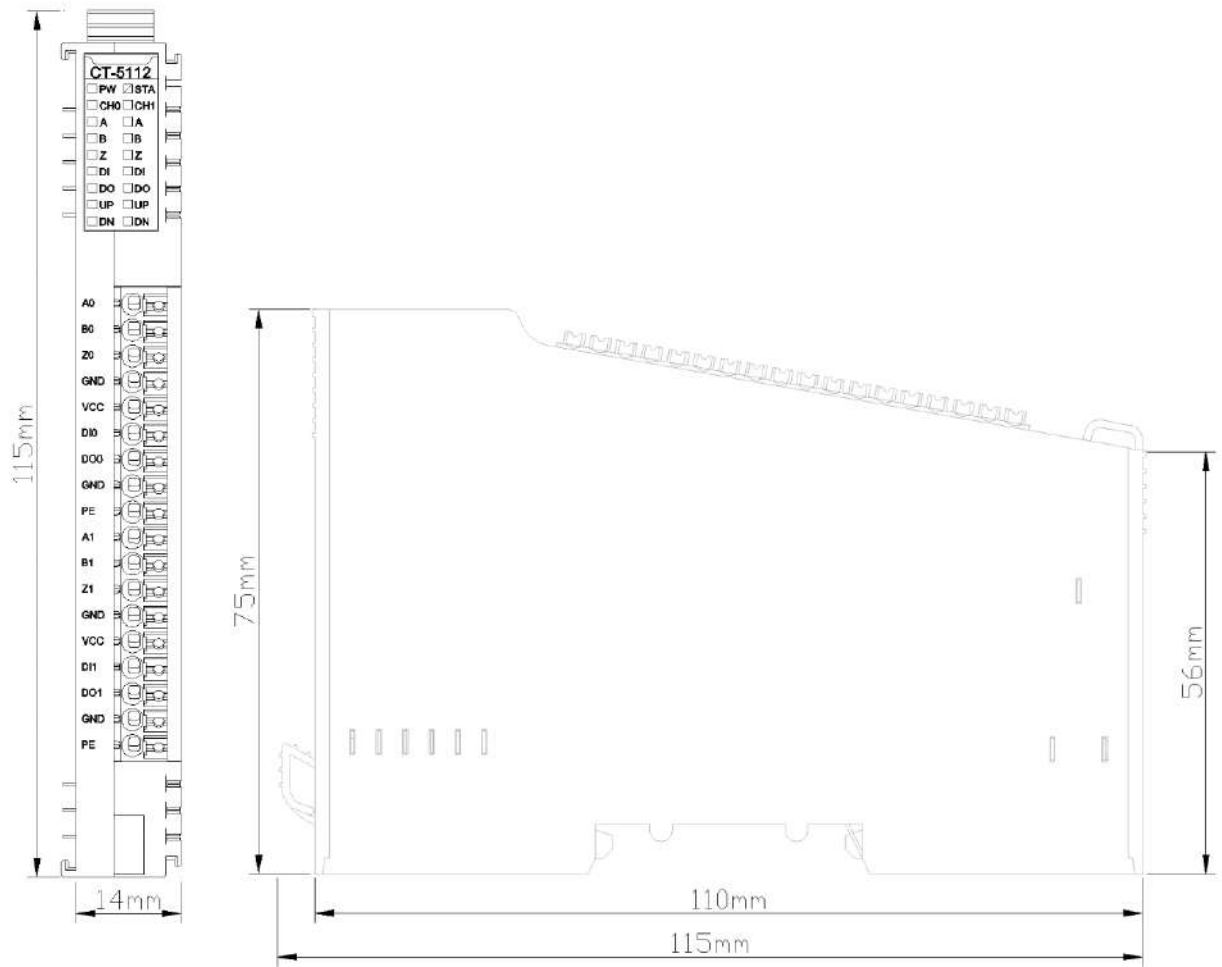

7 CT-5112 Submodule configuration parameter description

7.1 D/O Function Selection

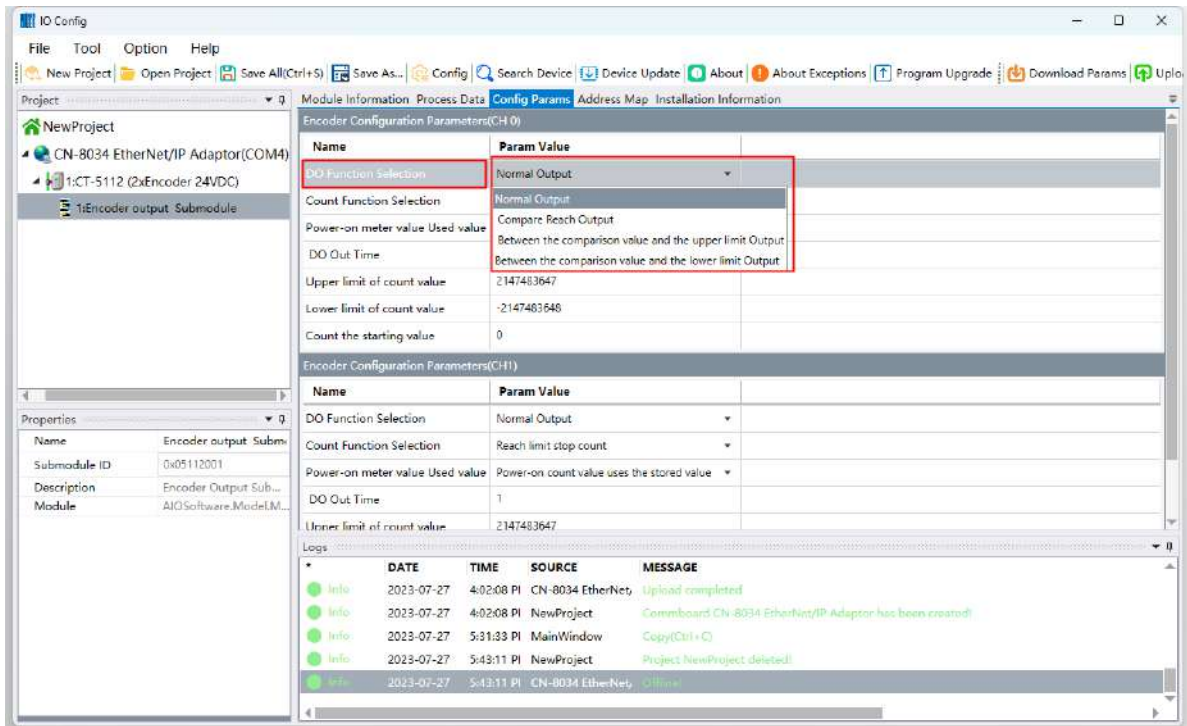

Normal Output

“Normal Output” is “CT-5112 Encoder output Submodule” configuration parameter, and “DO Function Selection” option is selected as default parameter. When the DO Function Selection option is this parameter, DO is still controlled by CT-5112 process data comparison control bit.

Compare value output reached

When the “Encoder output Submodule” configuration parameter “DO Function Selection” option parameter is set to this parameter, after the “Compare Value” is correctly set and enabled through the submodule process data, when the CT-5112 Counter Value reaches the Compare Value, DO will be output, and the output time is maintained for 1ms (default).

Output between the comparison value and the upper limit

When the “Encoder output Submodule” configuration parameter “DO Function Selection” option parameter is set to this parameter, after the “Compare Value” is

correctly set and enabled comparison control bit through the submodule process data, when the CT-5112 “Counter Value” is within the range of Compare Value and Upper limit of count value, DO will Output, and it will output until CT-5112 Counter Value is out of range.

Output between the comparison value and the lower limit

When the “Encoder output Submodule” configuration parameter “DO Function Selection” option parameter is set to this parameter, after the “Compare Value” is correctly set and enabled comparison control bit through the submodule process data, when the CT-5112 Counter Value is within the range of Compare Value and Lower limit of count value, DO will Output, and it will output until CT-5112 Counter Value is out of range.

7.2 Count Function Selection

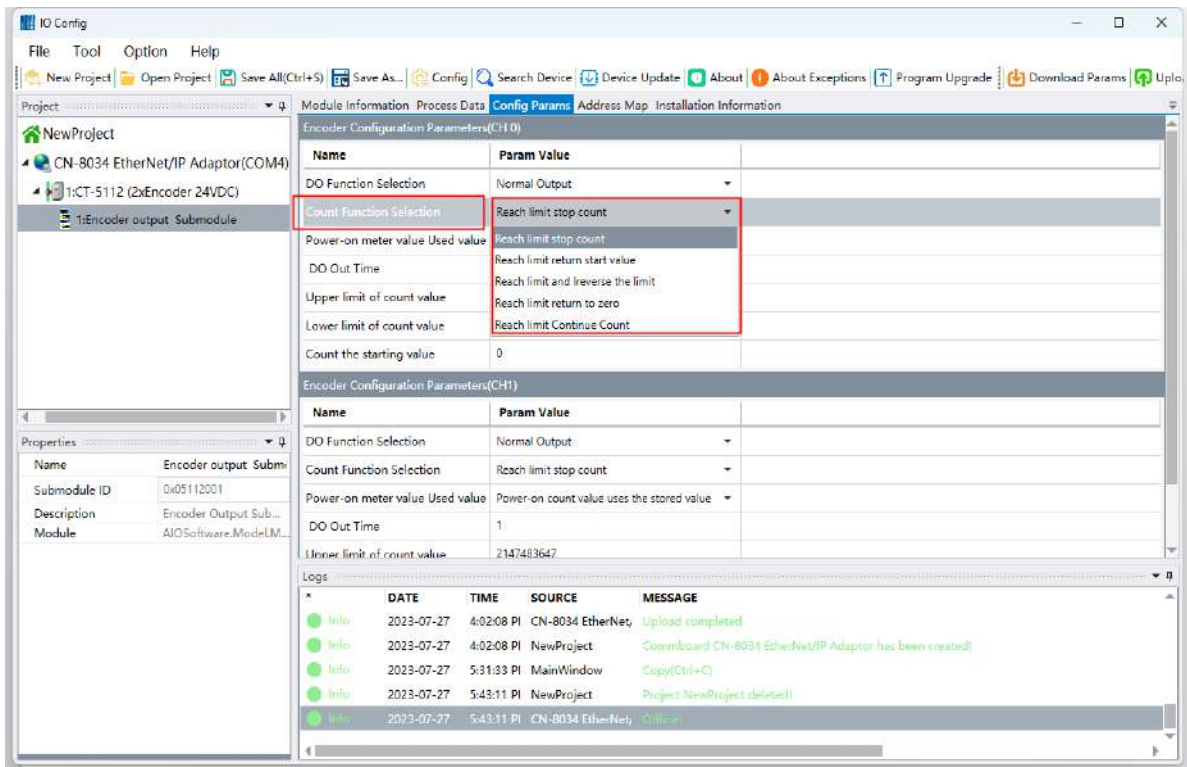

Reach limit stop count

“Reach limit stop count” is the default parameter of the “CT-5112 Encoder output Submodule” configuration parameter “Count Function Selection” option. When the “Count Function Selection” option is this parameter, and when the CT-5112 Counter Value reaches the “Upper limit of count value” or “Lower limit of count value”, and “CT- 5112 Counter Value” will stop counting up or down.

Reach limit return start value

When the “Encoder output Submodule” configuration parameter “Count Function Selection” option parameter is set to this parameter, and when the “CT-5112 Counter Value” reaches the Upper limit of count value or Lower limit of count value, and “Count the starting value” will be assigned to the “CT-5112 Counter Value”.

Reach limit and reverse the limit

When the “Encoder output Submodule” configuration parameter “Count Function Selection” option parameter is set to this parameter, when the “CT-5112 Counter Value”

reaches the “Upper limit of count value”, and it will assign the “Lower limit of count value” to “CT-5112 Counter Value”, on the contrary, when the “CT-5112 Counter Value” reaches the “Lower limit of count value”, and it will assign the “Upper limit of count value” to “CT-5112 Counter Value”.

Reach limit return to zero

When the “Encoder output Submodule” configuration parameter “Count Function Selection” option parameter is set to this parameter, when the “CT-5112 Counter Value” reaches the Upper limit of count value or Lower limit of count value, and “0” will be assigned to the “CT-5112 Counter Value”.

Reach limit Continue Count

When the “Encoder output Submodule” configuration parameter “Count Function Selection” option parameter is set to this parameter, when the “CT-5112 Counter Value” reaches the “Upper limit of count value” or “Lower limit of count value”, and the CT-5112 Counter Value will not be affected.

7.3 Power-on meter value Used value

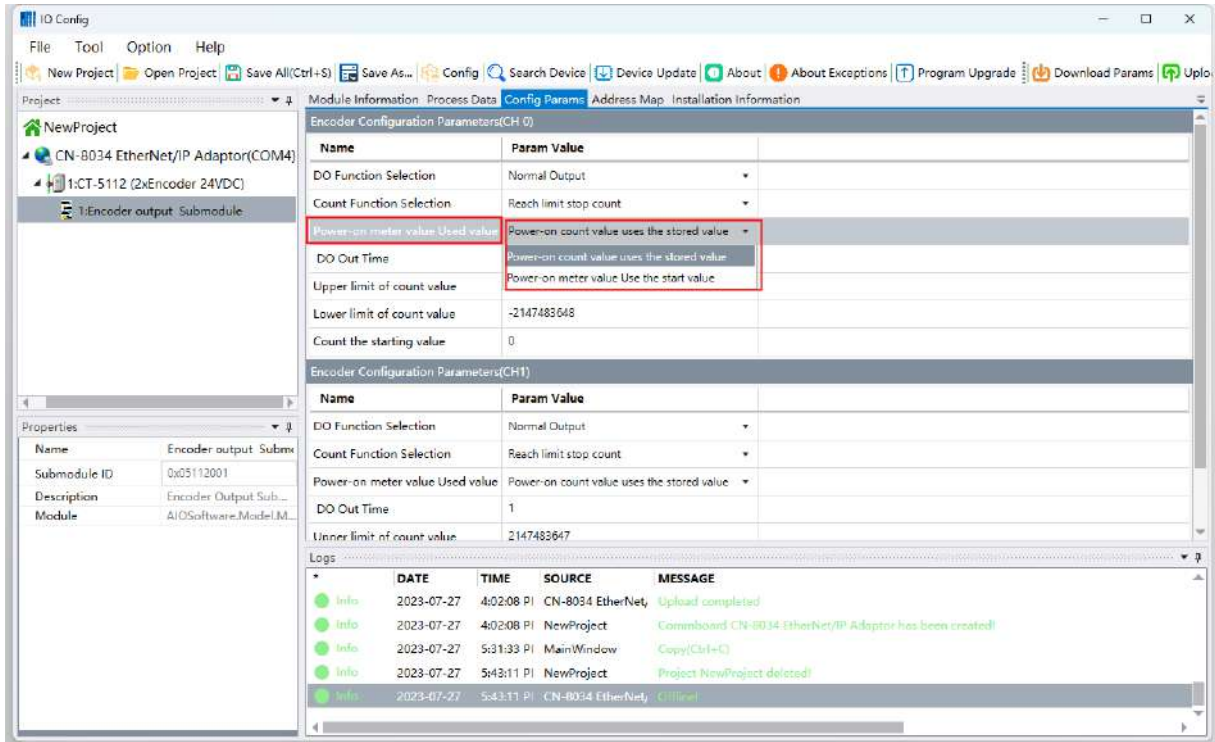

Power-on count value uses the stored value

“Power-on count value uses the stored value” is the default parameter of “CT-5112 Encoder output Submodule” configuration parameter “Power-on meter value Used value” option, when “Power-on meter value Used value” option is this parameter, and “CT-5112 Counter Value” will be based on CT-5112 configures whether the parameter counter storage option is enabled to perform corresponding initialization.

Power-on meter value Use the start value

When the “Encoder output Submodule” configuration parameter “Power-on meter value Used value” option parameter is set to this parameter, the initial value of “CT-5112 Counter Value” will be “Count the starting value” (if the CT-5112 configuration parameter counter storage option is enabled, the stored value will be overwritten with Count the starting value).

7.4 D/O Output Time

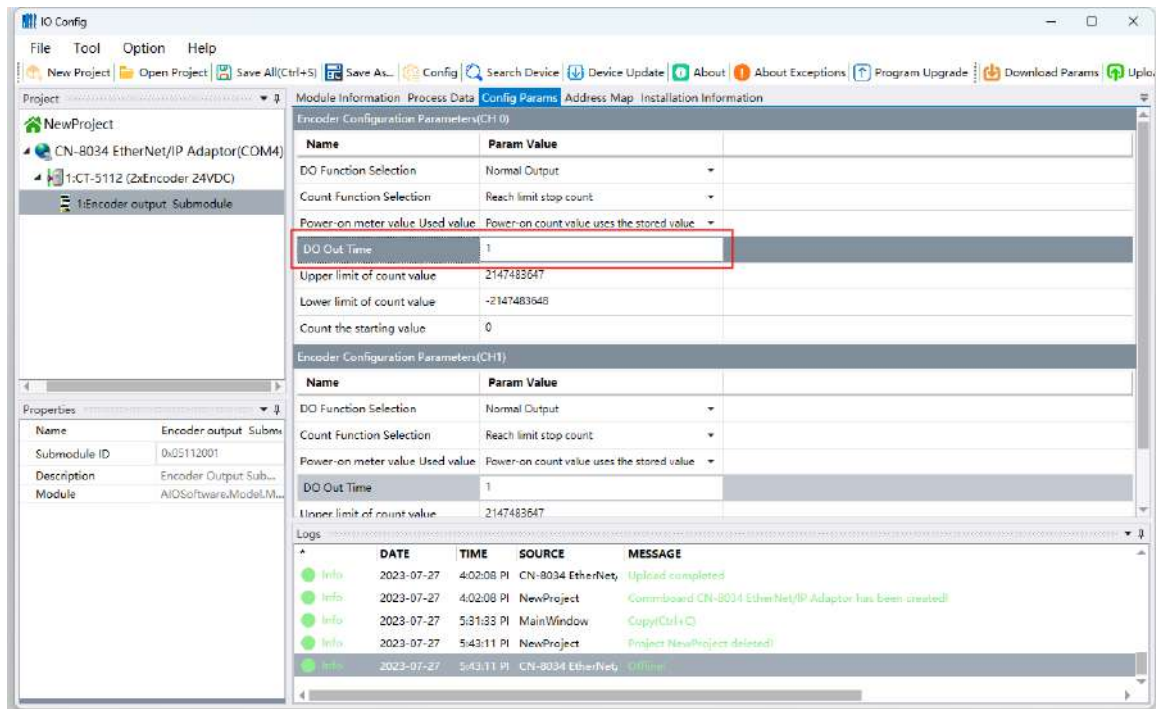

This parameter is valid only when the “Encoder output Submodule” configuration parameter “DO Function Selection” option parameter is set to “Reach Compare Value Output”, and it is a parameter of DO output time. The default value is “1”, the value range is “1-65535”, and the unit is “ms”.

7.5 Upper limit of count value

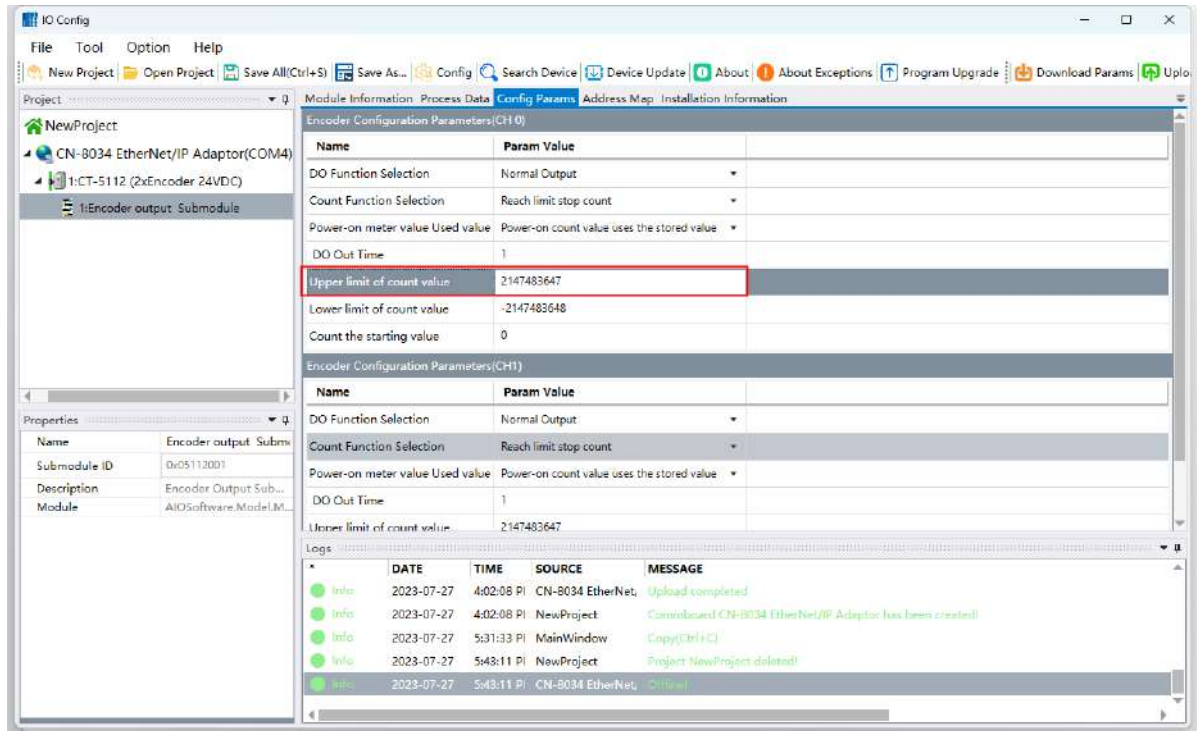

This parameter is the upper limit of “CT-5112 Count Value”, and the default value is 2147483647, and the value range is -2147483648~2147483647 (Note: “Upper limit of count value” must be bigger than “Lower limit of count value”).

7.6 Lower limit of count value

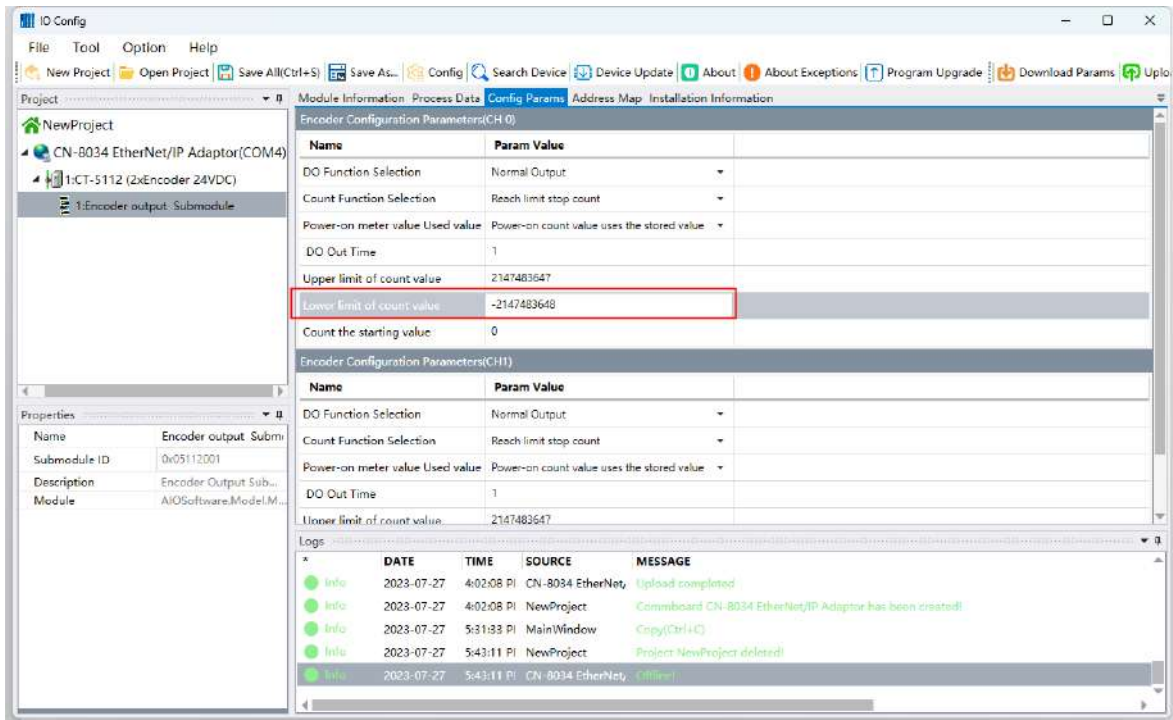

This parameter is the lower limit of “CT-5112 Count Value”, the default value is -2147483647, and the value range is -2147483648~2147483647 (Note: “Lower limit of count value” must be smaller than “Upper limit of count value”).

7.7 Count the starting value

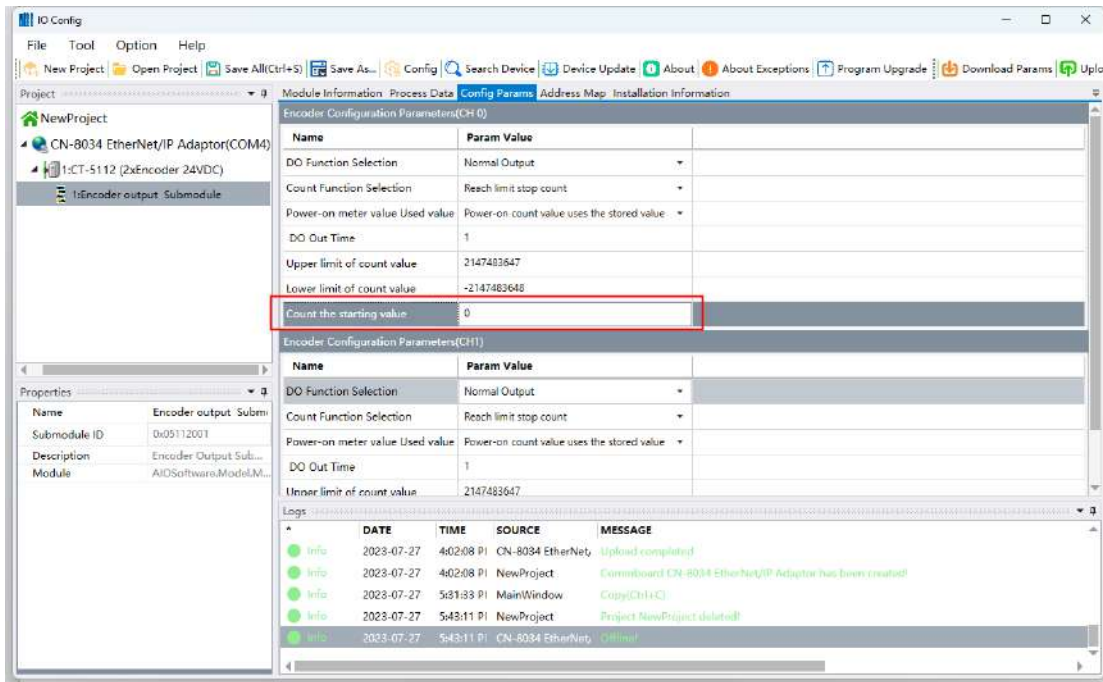

The default value is “0”, and the value range is -2147483648~2147483647.

8 CT-5112 Submodule process data description

8.1 IO Input

The screenshot shows a software interface with a project tree on the left and a main window displaying IO data. The project tree includes 'NewProject', 'CN-9034 EtherNet/IP Adaptor(COM4)', '1:CT-5112 (2zEncoder 24VDC)', and 'Encoder output Submodule'. The main window has tabs for 'Module Information', 'Process Data', 'Lonlog Params', 'Address Map', and 'Installation Information'. The 'Process Data' tab is active, showing 'IO Input' and 'IO Output' sections.

IO Input:

NAME	TYPE	ONLINE VALUE
Error Diagnosis Data(CH 0)	Unsigned16	--
Set Limit Value Error Sta	Bit	--
Set Start Value Error Sta	Bit	--
Set Compare Value Errc	Bit	--
Unused	Bit	--
Unused	Bit	--
Unused	Bit	--
Unused	Bit	--
Unused	Bit	--
Unused	Bit	--
Unused	Bit	--
Unused	Bit	--
Unused	Bit	--
Unused	Bit	--
Unused	Bit	--
Unused	Bit	--
Unused	Bit	--
Unused	Bit	--
Unused	Bit	--
Error Diagnosis Data(CH 1)	Unsigned16	--
Compare Value(CH 0)	Integer32	--
Compare Value(CH 1)	Integer32	--

IO Output:

NAME	TYPE	ONLINE VALUE	PROJECT VALUE
Output Control(CH 0)	Unsigned16	--	0x0000
Output Control(CH 1)	Unsigned16	--	0x0000
Compare Value(CH 0)	Integer32	--	0x00000000
Compare Value(CH 1)	Integer32	--	0x00000000

The 'Properties' window at the bottom left shows the following details for the 'Encoder output Submodule':

- Name: Encoder output Submodule
- Submodule ID: 0x05112001
- Description: Encoder Output Submodule
- Module: AIOSoftware.Model.M...

Error Diagnosis Data

8.1.1 Set Limit Value Error Status

Set the error flag bit of “Upper limit of count value” or “Lower limit of count value”. This error will be reported when the “Upper limit of count value” is less than or equal to the “Lower limit of count value”. When the “Encoder output Submodule” configuration parameter “Count Function Selection” option parameter is set to “Reach limit return to zero”, and 0 is not within the range of Upper limit of count value and Lower limit of count value, and this error will be reported.

8.1.2 Set Start Value Error Status

Set the “Count the starting value” error flag bit. This error will be reported when “Count the starting value” is not within the range of “Upper limit of count value” and “Lower

limit of count value”.

8.1.3 Set Compare Value Error Status

Set the “Compare Value” error flag bit. This error will be reported when “Compare Value” is not within the range of “Upper limit of count value” and “Lower limit of count value”.

(Note: When any of the above error states exists, the count control and DO output of the sub-module will be invalid.)

8.1.4 Compare Value

Pulse comparison value, 32-bit signed integer, after the “Compare Value” of “IO Output” area is correctly set and enabled through the sub-module process data (IO Output), and this parameter will display the corresponding value, which is convenient for users to observe whether the “Compare Value” is written correctly.

8.2 IO Output

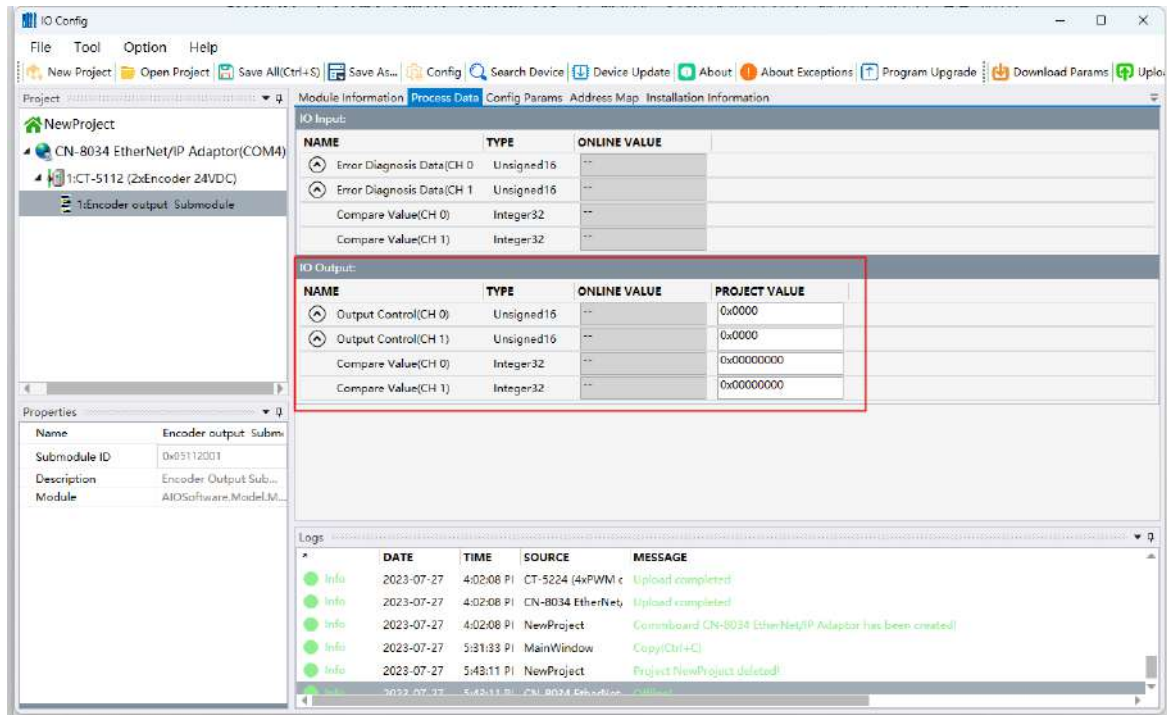

Output Control

1) Compare Control Bit

The pulse comparison value sets the trigger bit, the rising edge triggers the comparison value setting, the output value and “Compare Value” will be updated to the input value “Compare Value”, and keep the pulse comparison output of this bit running normally.

2) Compare Value

Pulse compare value, 32-bits signed integer.

9 CT-5112 Sub-module Communication Example

9.1 Add sub-module

1) Open the IO Config (software), create a new project

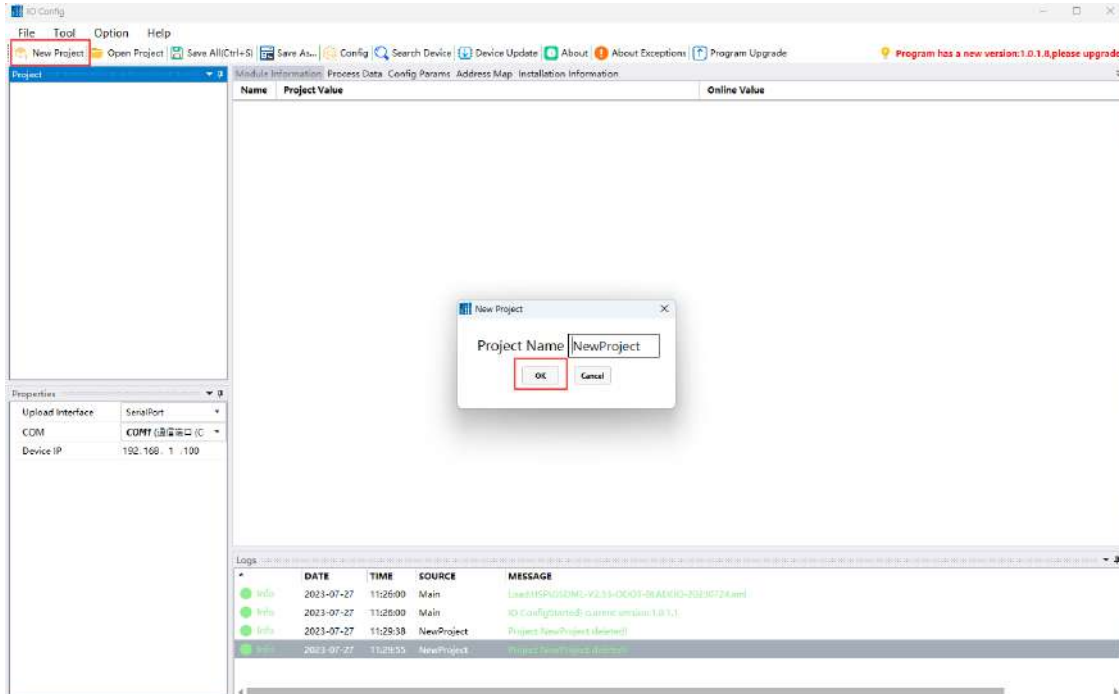

2) Select the serial port interface, select the serial port number corresponding to the device, and click “Upload Module”.

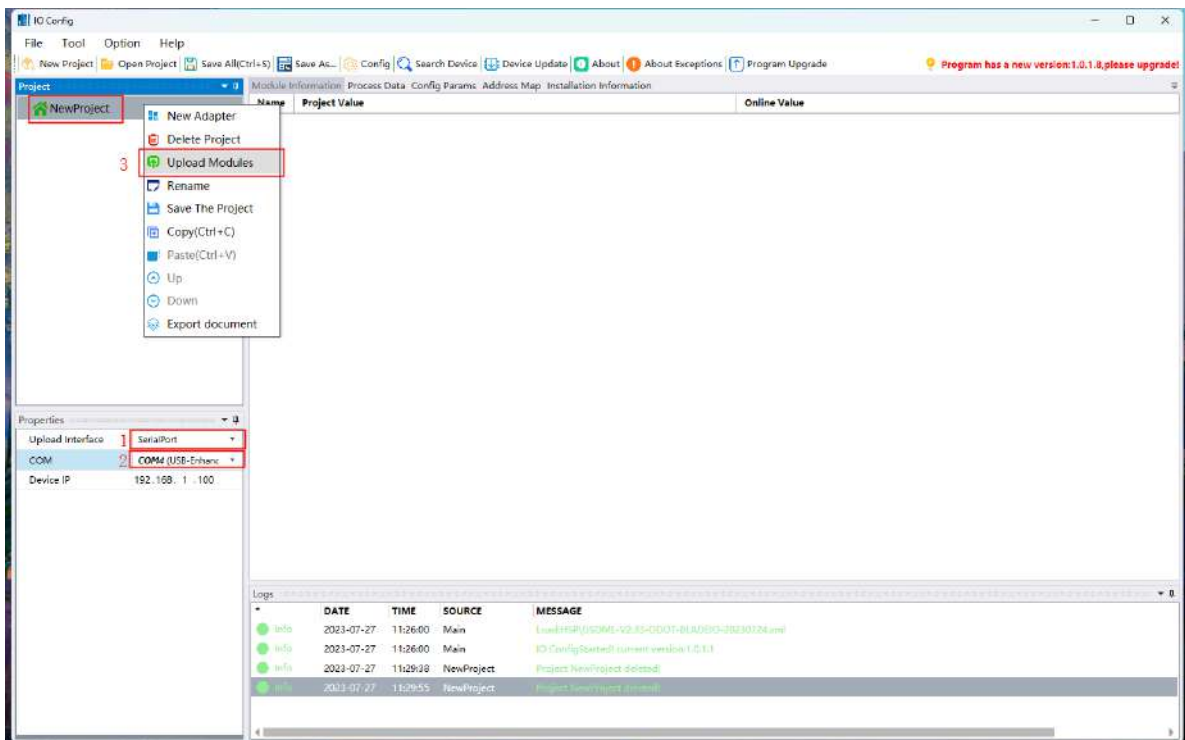

3) Click CT-5112, and right click Submodule Manager to add the CT-5112 Encoder output Submodule.

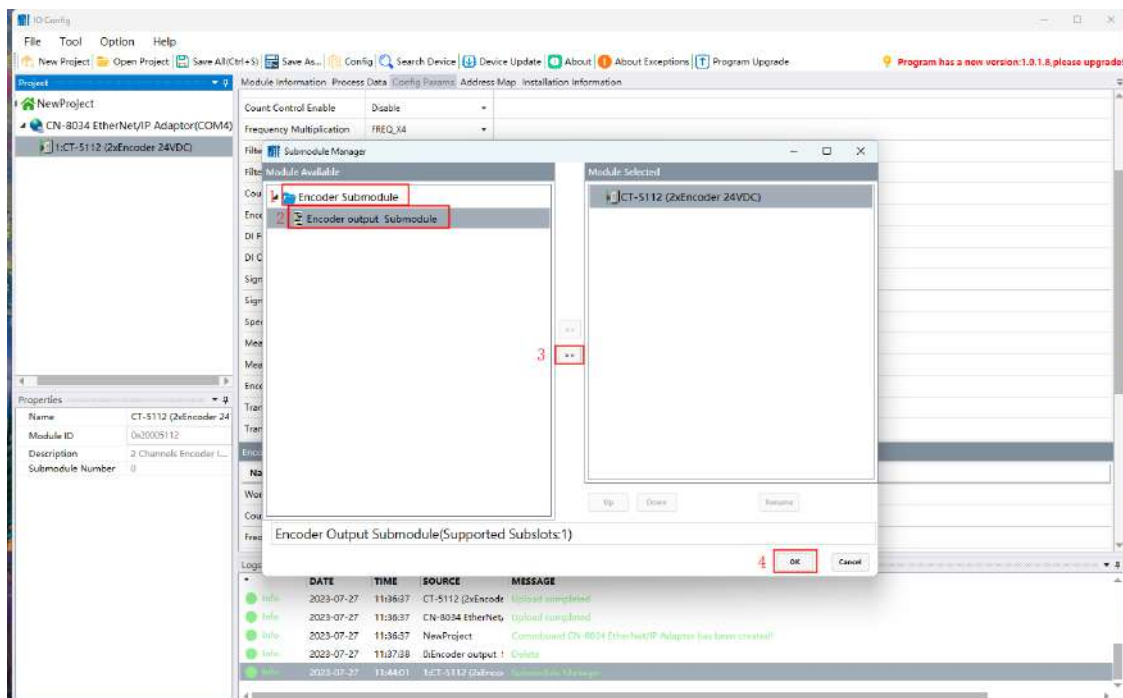
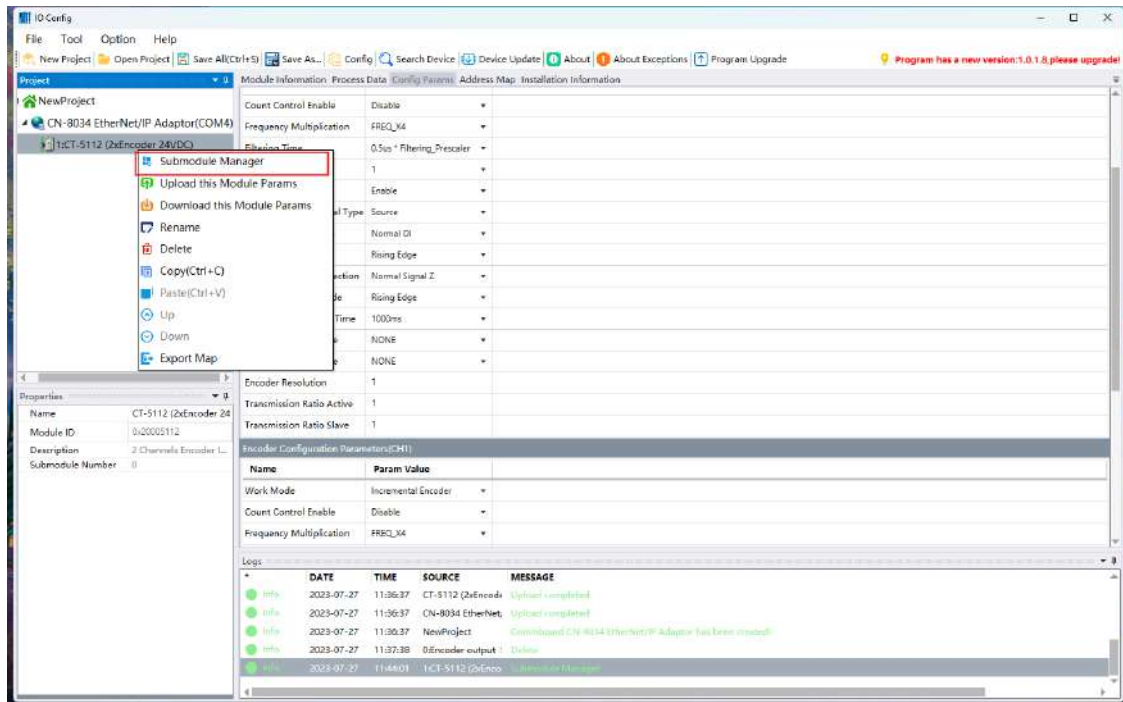

4) Click the adapter to download the parameters and complete the adding of sub-modules.

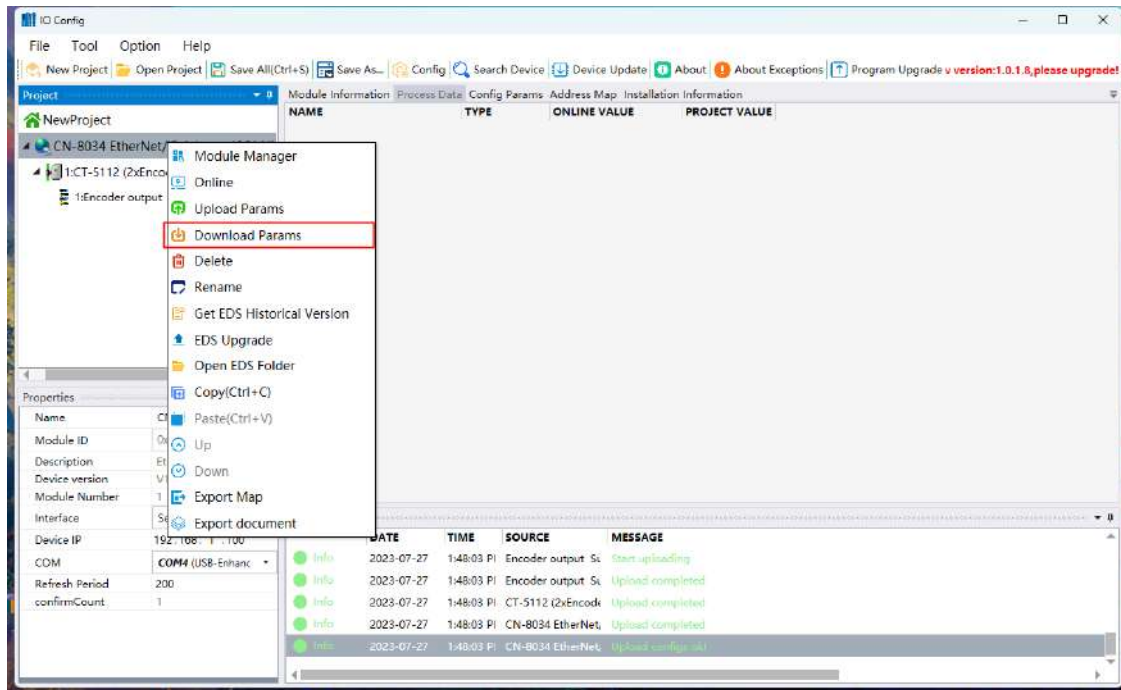

9.2 Sub-module parameter configuration and function display

- 1) Click “Encoder output Submodule” to configure submodule parameters. The example configuration details are shown in the figure below.

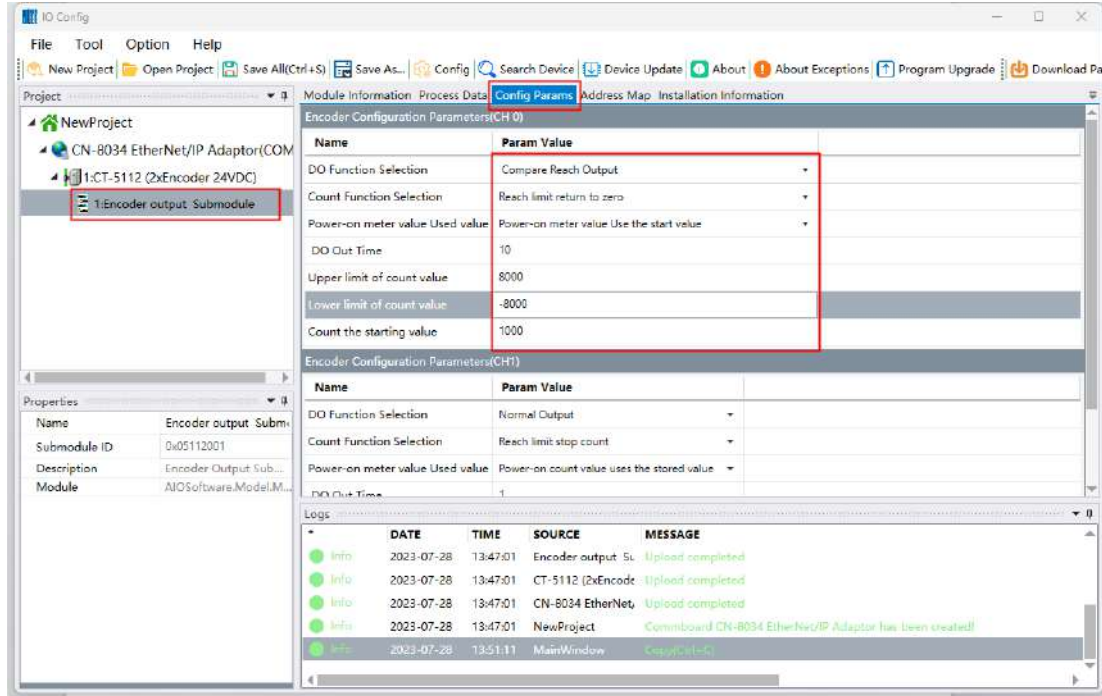

- 2) Click on the adapter to download the parameters.

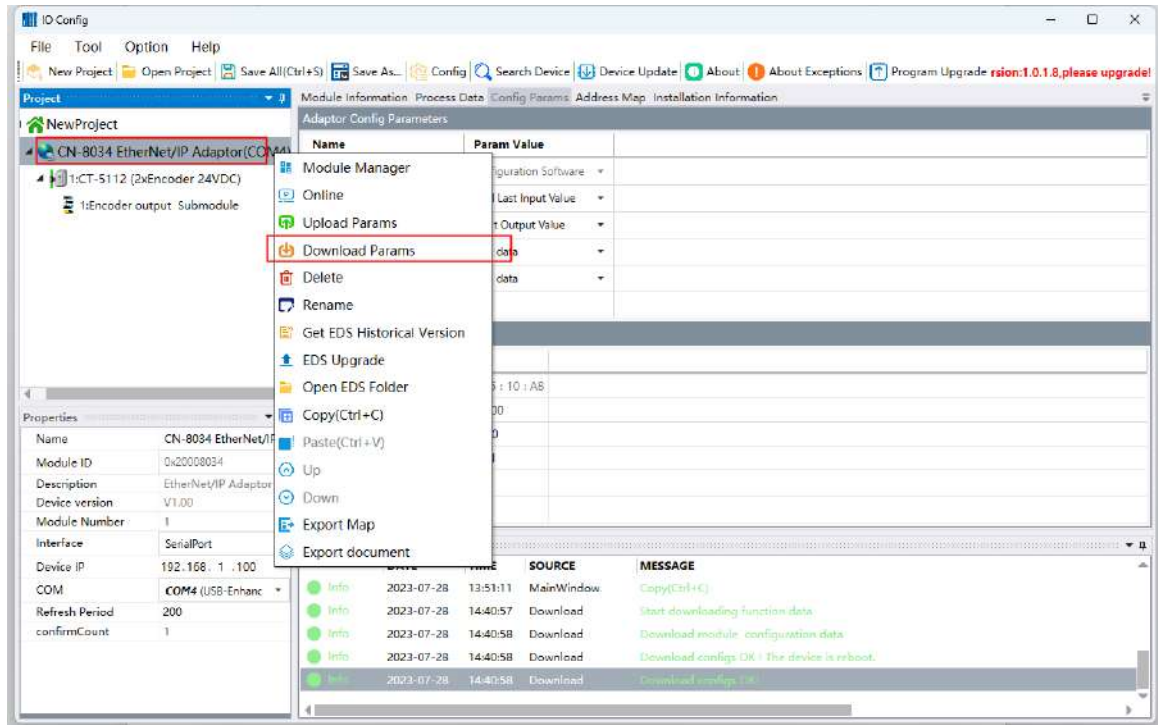

3) Click the adapter, right click the Online, and click the CT-5112 sub-module process data, and select decimal display.

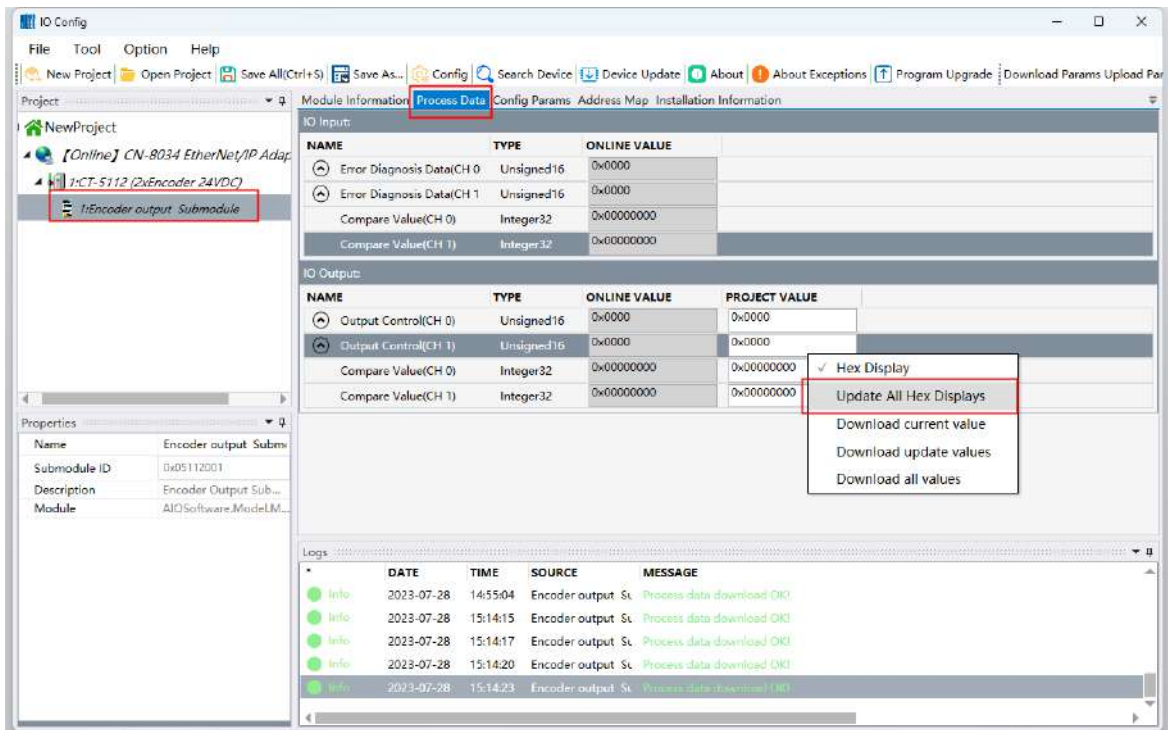
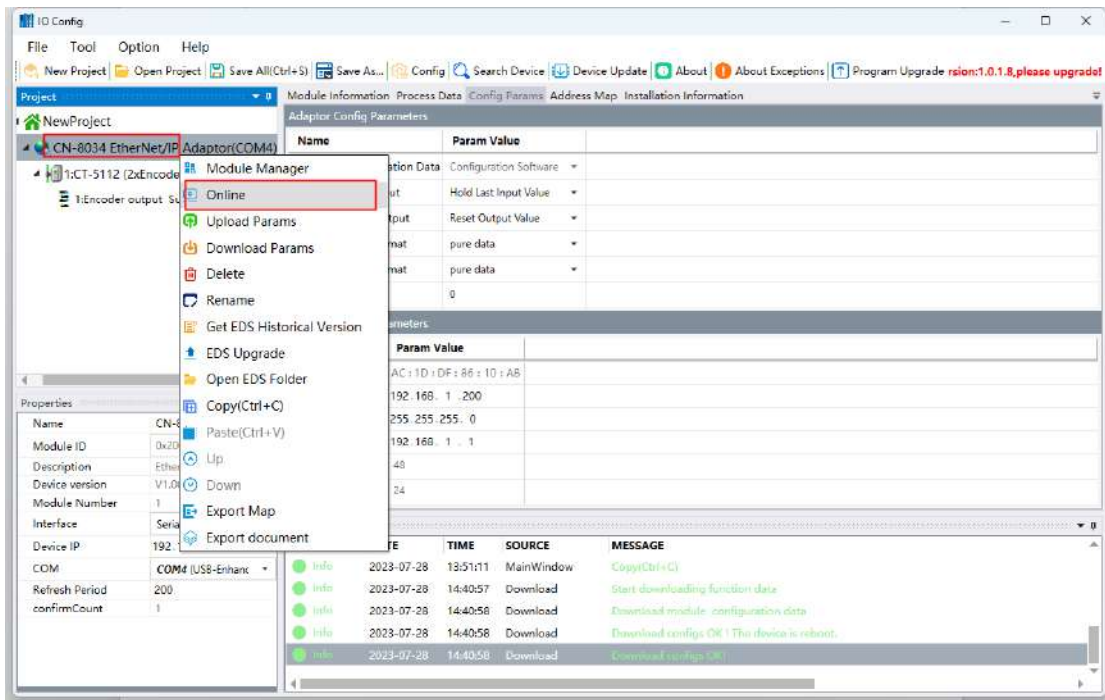

4) Check the status of “Error Diagnosis Data” to ensure that the configuration parameters are set correctly.

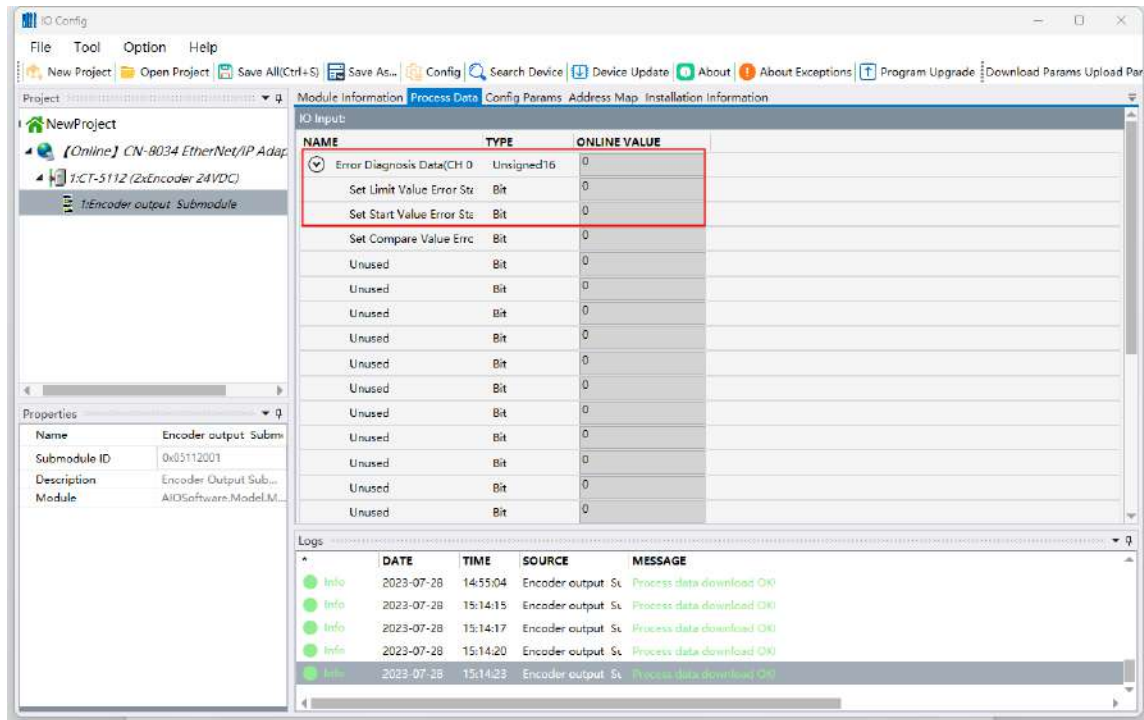

5) Assign 4000 to “Compare Value (ch0)”.

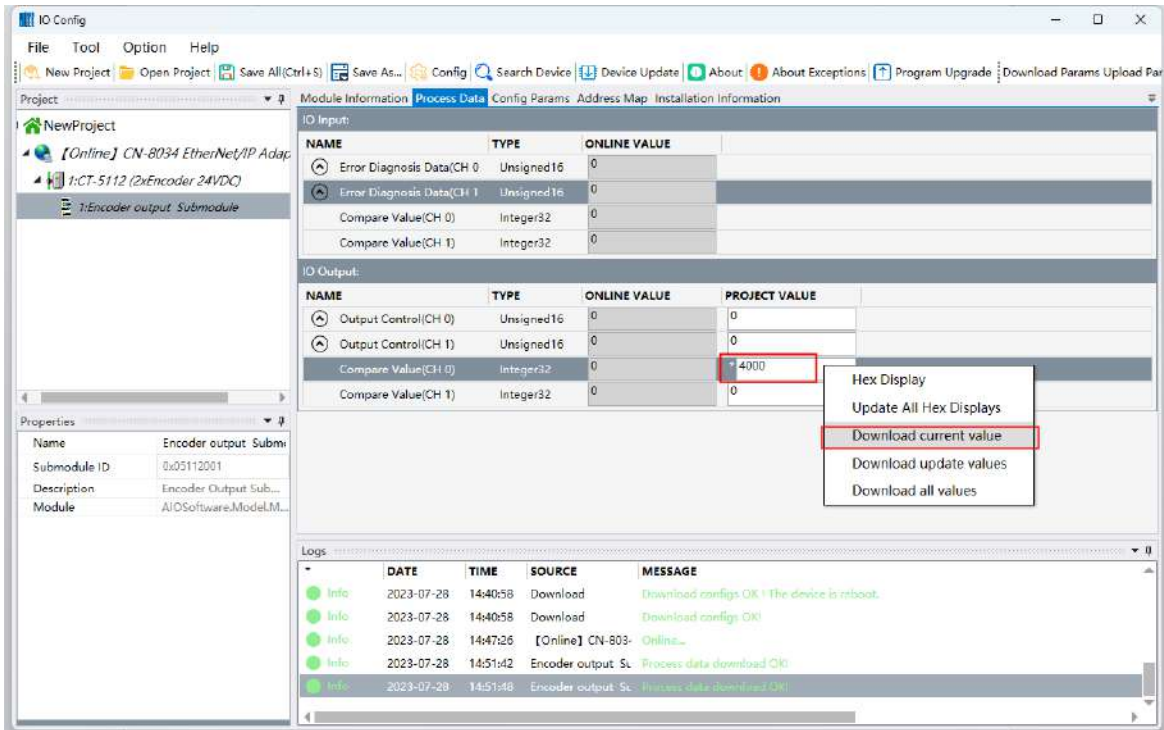

6) The rising edge triggers “Compare Control”, and the “Compare Value (ch0)” will be set as the pulse comparison value and latched.

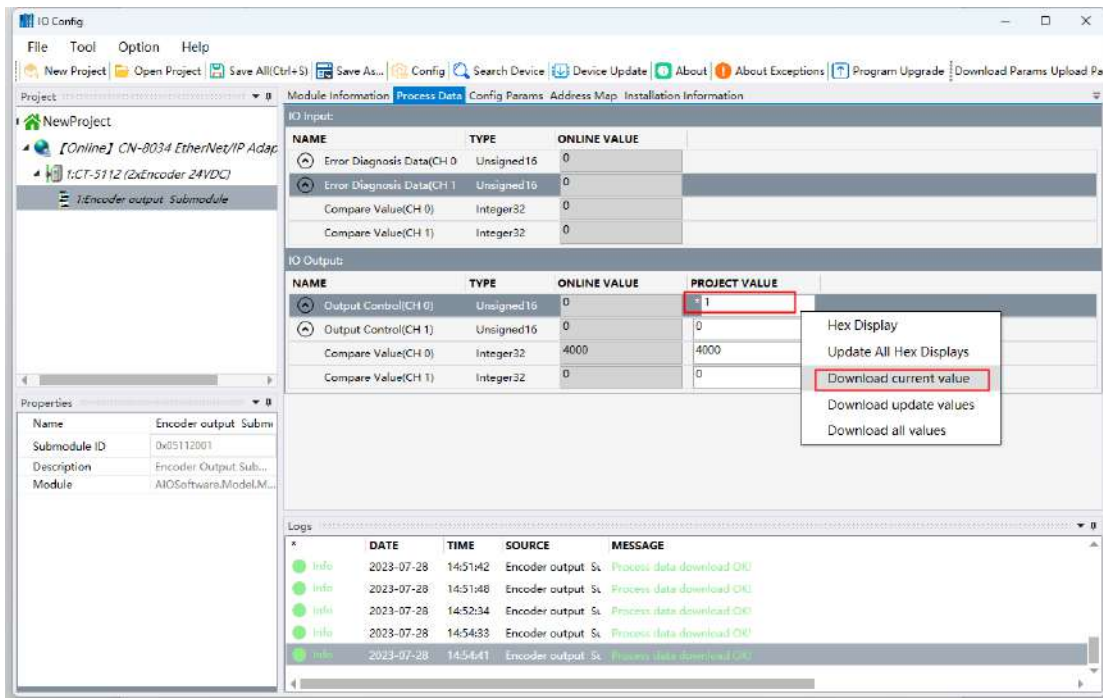

7) Check the status of “Error Diagnosis Data” to ensure that the “Compare Value” is set correctly, check whether the “IO Input Compare Value” is consistent with step 5, and ensure that the parameters are written correctly.

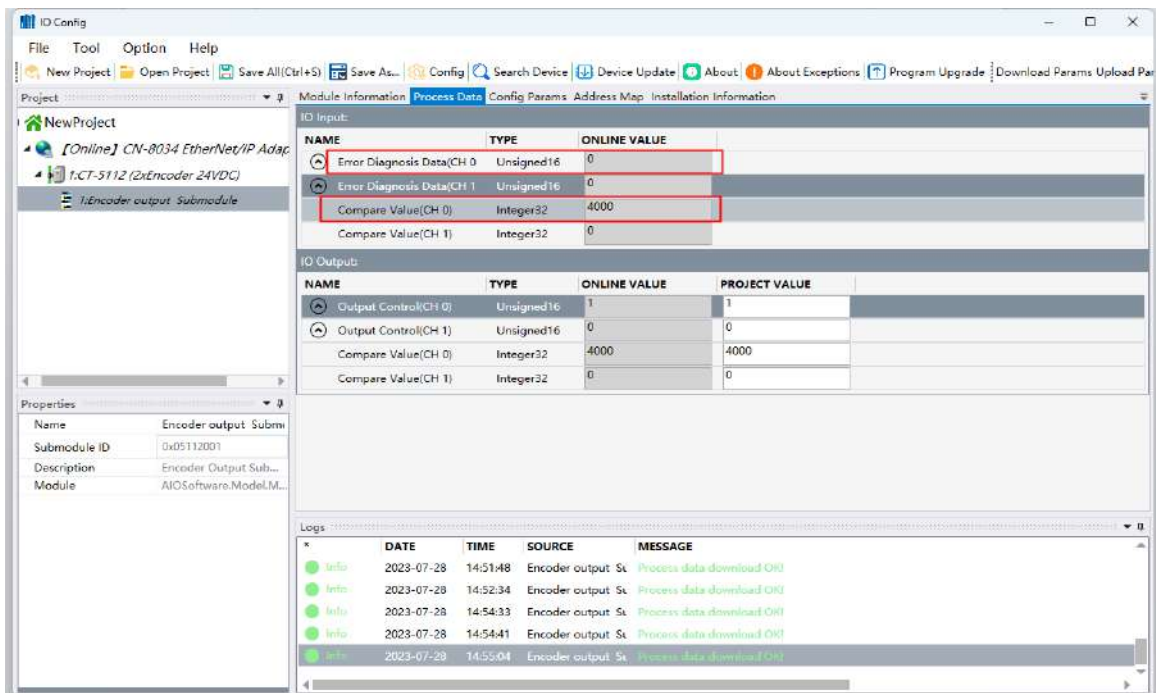

8) Click CT-5112, and click CT-5112 process data, it can see that the “Counter Value” is “Count the starting value”, which is consistent with the configuration parameters of the sub-module in step 1.

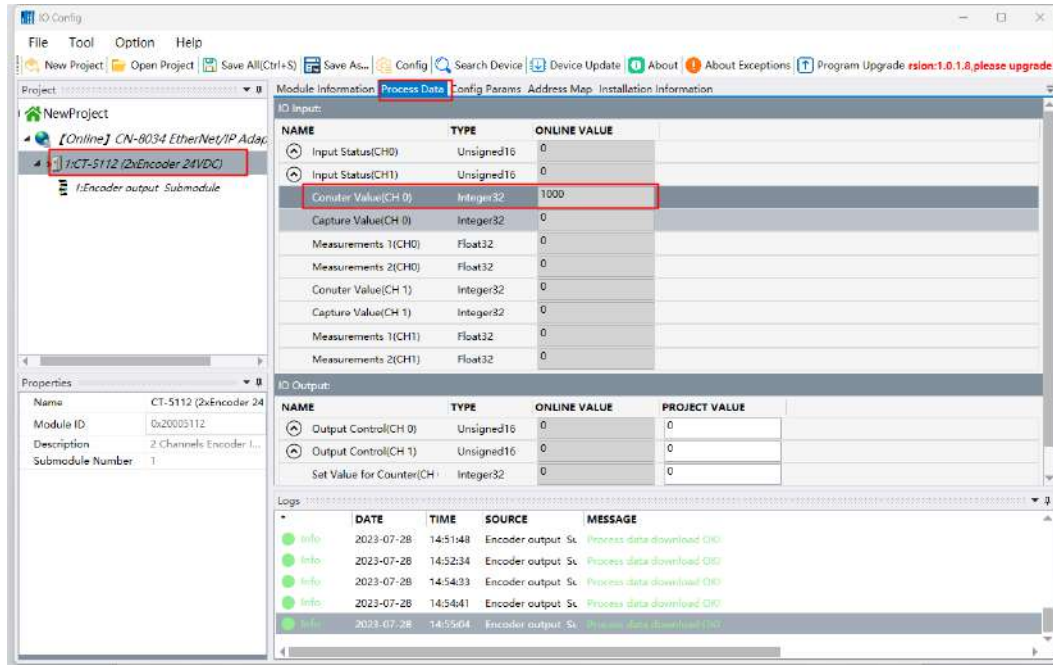

9) Turn the encoder forward to monitor the value of the counter value (ch0). When the “counter value” reaches the pulse comparison value of 4000, and DO will output a high-level signal. When the “counter value” reaches 8000, clear the count value and restart the pulse comparison.

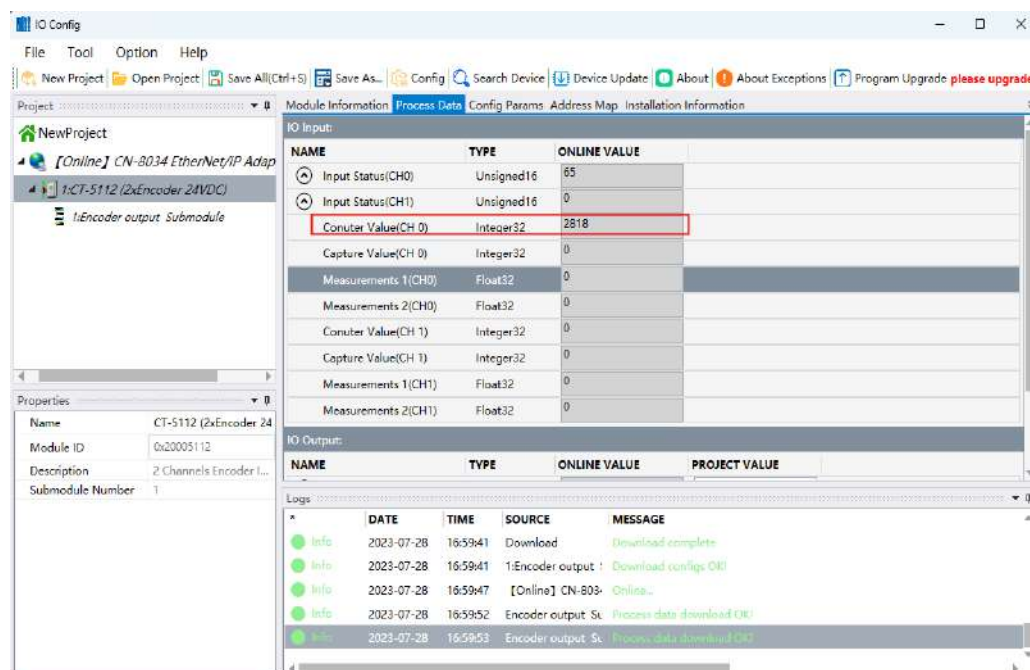

10) Observe that the pulse width of the DO output is 10ms through the oscilloscope, which is consistent with the configuration parameters.

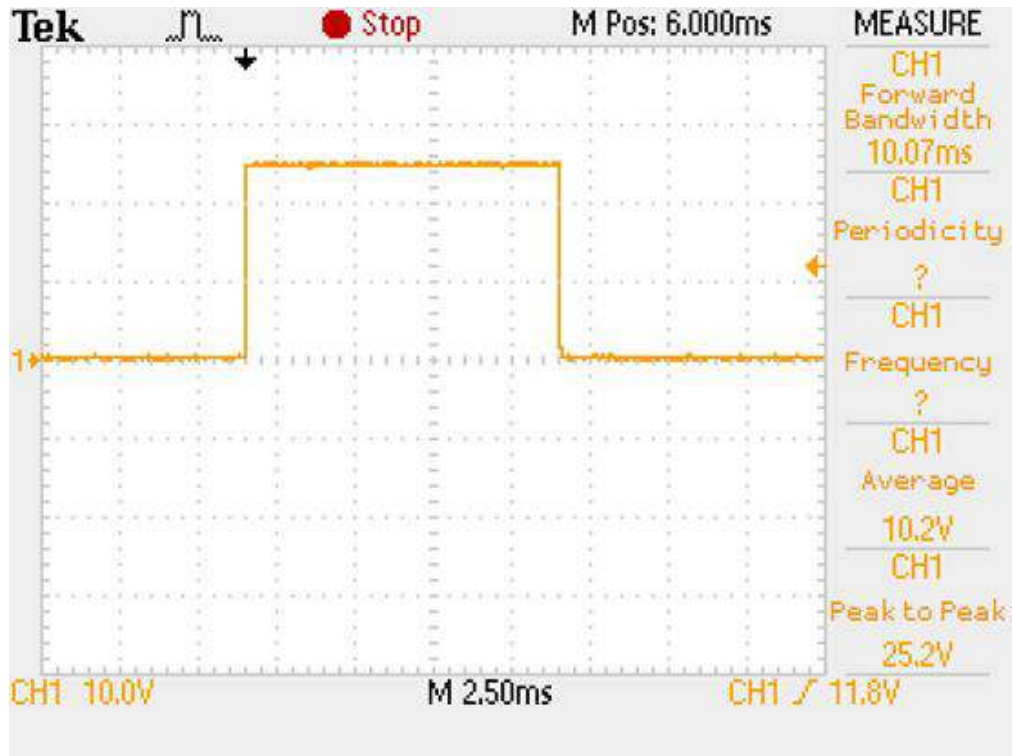

11) Turn the encoder in reverse, monitor the value of counter value (ch0), when the counter value reaches -8000, clear the count value.

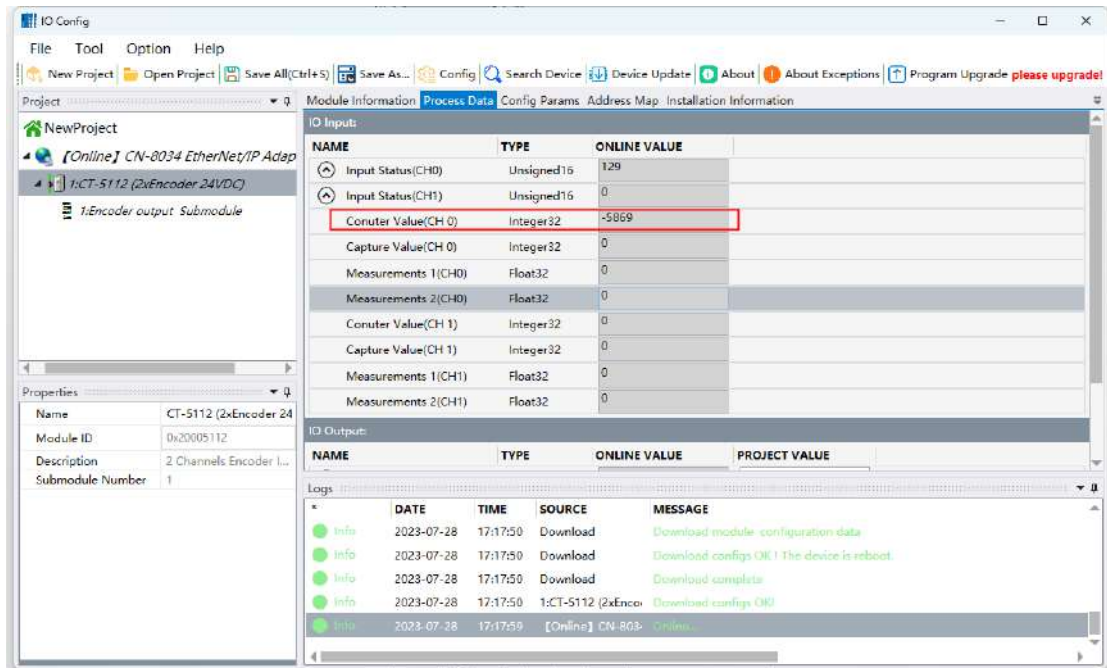

12) Set the “Output Value” – “Compare Control” bit to 0.

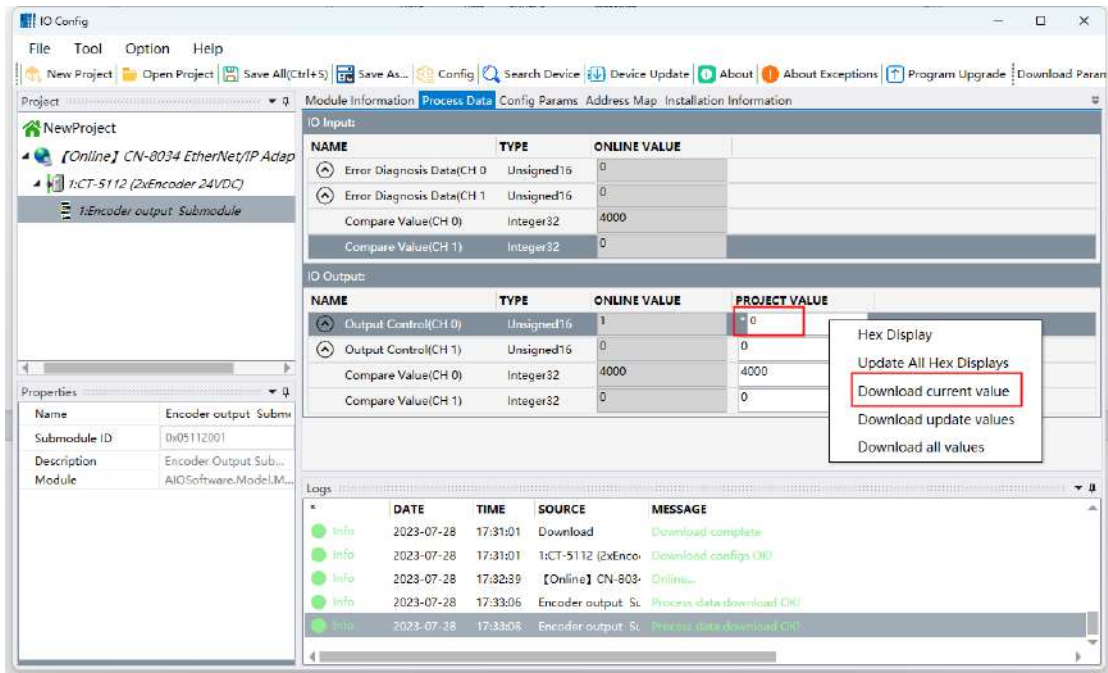

13) Turn the encoder forward to monitor the counter value (ch0). When the counter value reaches the pulse comparison value of 4000, DO will have no output. When the counter value reaches 8000, and it will clear the count value.

CT-5122 2-channels encoder/SSI input

1 Module features

- ◆ The module supports two channels of SSI encoder input.
- ◆ Each encoder channel supports SSI absolute encoder signal input.
- ◆ Each encoder channel supports 1 digital input signal with an input voltage of 5Vdc or 24Vdc.
- ◆ Each encoder channel supports 1 digital output signal with an output voltage of 5Vdc.
- ◆ The module internal bus and field input adopt magnetic isolation
- ◆ The module carries 16 LED indicators.
- ◆ The module supports the maximum clock frequency of 2MHz.
- ◆ The encoder reading interval time could be set.
- ◆ The data bit length and the start and end bit positions could be set.

2 Technical parameters

General Parameters	
Power	Max.65mA@5.0Vdc
Isolation	I/O to internal bus: magnetic isolation (3KVrms)
Field Power	Nominal:24Vdc, Range:20.4-28.8Vdc
Wiring	Max.: AWG 18
Mounting Type	35mm DIN-Rail
Size	115*14*75mm
Weight	65g
Environment Specification	
Operating Temperature of Horizontal Installation	-35°C~70°C
Operating Temperature of Vertical Installation	-35°C~60°C
Relative Humidity	< 95%RH (No Condensation)
Storage Temperature	-40°C~85°C
Storage Humidity	< 95%RH (No Condensation)
Manufacturing Test Temperature	-40°C~75°C
Ingress Protection Rating	IP20
Input Parameters	
Channel Number	2-channel encoder
LED Indicator	16 channel input LED indicator
Encoder Signal type	Differential signal, 5V
Data Frame Length	10-40 bit
Position Value Length	Maximun of 32 bit
Position Value Format	Supports gray code or binary
Location Value LSB/MSB	Settable
SSI Encoder Clock Frequency	≤2MHz
DI Turn-on Voltage	Min.5Vdc to Max.28Vdc
DI Turn-off Voltage	Max.2.7Vdc
DI Turn-on Current	Max.5mA/channel@28V
DI Input Impedance	>10.0kΩ
DI Input Delay	OFF to ON: Max.3ms ON to OFF: Max.2ms
DO Output Voltage	24V, range ±10%
DO Output Current	Max.500mA
DO Output Sink Current	Max.5uA

 **WARNING**

UNEXPECTED EQUIPMENT OPERATION

Do not exceed any of the ratings specified in the environmental and electrical characteristics table.

Failure to follow instructions specified by the manufacturer may result in serious consequences such as death, personal injury, or damage to equipment since the protection provided by the equipment may be impaired.

 **AVERTISSEMENT**

FONCTIONNEMENT INATTENDU DE L'EQUIPEMENT

Ne dépassez aucune évaluation spécifiée dans le tableau de caractéristiques environnementales et électriques..

Le fait de ne pas suivre les instructions peut entraîner une défaillance de la protection fournie par l'équipement, ce qui peut entraîner des conséquences graves, comme des blessures ou des dommages à l'équipement.

3 Hardware interfaces

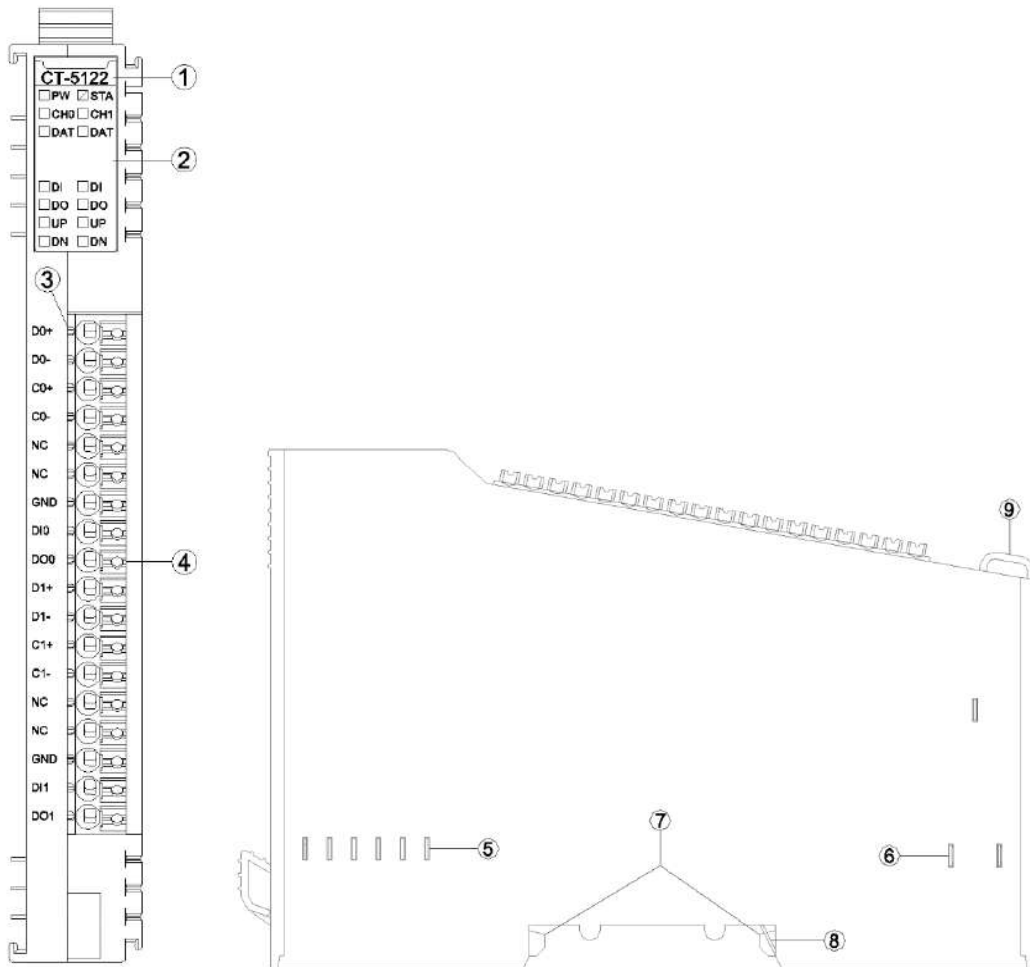

- ① Module Type
- ② State indicator
- ③ Channel indicator
- ④ Wiring Terminal and identification
- ⑤ Internal Bus
- ⑥ Field Power
- ⑦ Buckle
- ⑧ Grounding Spring Sheet
- ⑨ Fixed Wiring Harness

3.1 LED indicator definition

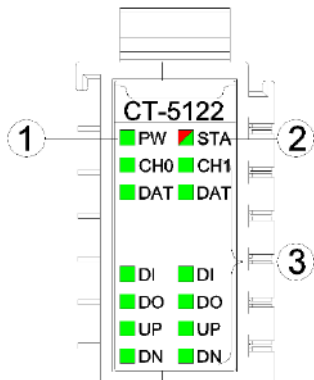

- ① Power LED indicator (green)
- ② Module State indicator LED (red/green)
- ③ Input channel indicator LED (green)

PW Power State	Definition
ON	Internal bus power supply normal
OFF	Internal bus power supply failure
STA Module State	Definition
Green slow flash (2.5 Hz)	Module internal bus is not started
Red slow flash (2.5 Hz)	Module internal bus offline
ON (GREEN)	Operation normal
Flash (2.5 Hz) (RED/GREEN)	updating mode
Flash (10 Hz) (RED/GREEN)	firmware update
Double Flash (RED)	Module exception has been soft-restarted
CH0 CH1 channel indicator LED	Definition
ON	Channel enable
DAT channel indicator LED	Definition
ON	The input data line is at high level when idle
OFF	The input data line is at low level when idle
DI input indicator	Definition
ON	Input signal high level
OFF	Input signal invalid
DO output indicator	Definition
ON	Output signal high level
OFF	Output signal invalid
UP indicator	Definition
ON	Encoder in positive rotation
OFF	Encoder is stationary or in contrarotation
DN indicator	Definition
ON	Encoder in contrarotation
OFF	Encoder is stationary or in positive rotation

WARNING

UNEXPECTED EQUIPMENT OPERATION

By viewing the PW indicator, could determine the power supply status of a module. If the PW is steady green, the power supply is normal. Otherwise, the module cannot work properly.

When the module is initially powered on, there will be 3S for the backplane bus connection. After the backplane bus is initialized, STA is in the green steady state. If STA is in the green blinking state, it indicates that the backplane bus has not been initialized, and it needs to be powered off and restarted for re-initialization.

STA abnormal working state occurs during the normal operation of the module, please check the firmware version information of all modules, and consult ODOT technical support for details.

If a module is upgraded, check that all modules are in the normal state after the upgrade. Otherwise, an exception may occur.

Failure to follow instructions specified by the manufacturer may result in serious consequences such as death, personal injury, or damage to equipment since the protection provided by the equipment may be impaired.

AVERTISSEMENT

FONCTIONNEMENT INATTENDU DE L'EQUIPEMENT

En regardant l'état de l'indicateur de PW, jugez l'état d'alimentation du module. Le feu vert PW reste allumé et l'alimentation est normale. Autrement, le module ne fonctionnera pas correctement.

Lorsque le module est alimenté initialement, il y aura 3S pour la connexion de bus de backboard. STA est un état vert permanent après l'initialisation du bus de backboard. Si STA est en état de clignotement vert, cela signifie que l'initialisation du bus de backboard n'est pas passée et doit être redémarrée hors tension et réinitialisée.

L'état de fonctionnement anormal de STA se produit pendant le fonctionnement normal du module, veuillez vérifier les informations de version du firmware de tous les modules, et consulter le support technique ODOT pour plus de détails.

Si le module a une opération de mise à niveau, après l'achèvement de la mise à niveau, le besoin de vérifier que tous les modules sont dans l'état normal avant de courir, sinon il conduira à une exception.

Le fait de ne pas suivre les instructions peut entraîner une défaillance de la protection fournie par l'équipement, ce qui peut entraîner des conséquences graves, comme des blessures ou des dommages à l'équipement.

3.2 Field channel LED indicator (Green)

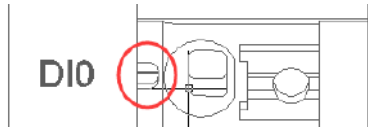

When the input signal of the input channel is valid, the corresponding field channel indicator is on (only the DI/DO wiring terminal of the encoder channel carries the indicator).

3.3 Terminal definition

Terminal Number	Symbol	Description
1	D0+	CH0 encoder data input +
2	D0-	CH0 encoder data input -
3	C0+	CH0 encoder clock output +
4	C0-	CH0 encoder clock output -
5	NC	Not connected
6	NC	Not connected
7	GND	Signal ground
8	DI0	CH0 digital signal input
9	DO0	CH0 digital signal output
10	D1+	CH1 encoder input +
11	D1-	CH1 encoder data input -
12	C1+	CH1 encoder clock output +
13	C1-	CH1 encoder clock output -
14	NC	Not connected
15	NC	Not connected
16	GND	Signal ground
17	DI1	CH1 digital signal input
18	DO1	CH1 digital signal output

⚠ WARNING

UNEXPECTED EQUIPMENT OPERATION

Calculate the maximum field power current consumption of a single module based on the actual field load. If the total field power current consumption of all I/O modules exceeds the power supply capacity of the field power supply, you must add an extra power expansion module. Otherwise, an output channel exception may occur.

Failure to follow instructions specified by the manufacturer may result in serious consequences such as death, personal injury, or damage to equipment since the protection provided by the equipment may be impaired.

⚠️ Avertissement

FONCTIONNEMENT INATTENDU DE L'EQUIPEMENT

Calculez la consommation maximale de courant de champ d'un seul module en fonction de la charge de champ réelle. Si la consommation totale de courant de champ de tous les modules d'E/S dépasse la capacité d'alimentation de l'alimentation de champ, vous devez ajouter un module d'extension de puissance supplémentaire. Dans le cas contraire, une exception de canal de sortie peut se produire.

Le fait de ne pas suivre les instructions peut entraîner une défaillance de la protection fournie par l'équipement, ce qui peut entraîner des conséquences graves, comme des blessures ou des dommages à l'équipement.

When connecting a cold-pressed terminal, the terminal must be terminated and checked in strict accordance with the corresponding termination specifications or requirements, and connect the cold-pressed terminal according to the corresponding node serial number. The conductor should use copper conductor and the conductor core should be larger than 0.2mm^2 and smaller than 1mm^2 (AWG18~AWG24). Cold-pressed terminal parameters are as follows:

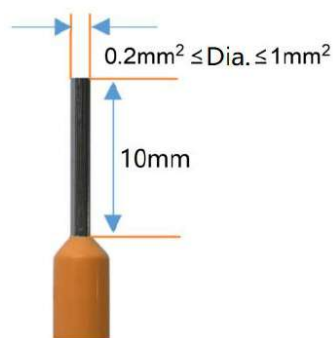

⚠️ WARNING

UNEXPECTED EQUIPMENT OPERATION

Strip the length of the conductor insulation layer is greater than 10mm to ensure reliable signal connection.

The wire needs to use copper wire and the wire core is greater than or equal to 0.2mm^2 and less than or equal to 1mm^2 to ensure reliable signal connection.

When connecting a cold-press terminal, connect the cold-press terminal strictly in accordance with the corresponding termination specifications or requirements, and connect the cold-press terminal according to the corresponding node serial number.

Do not power on cold-press terminals until they are properly connected or fully locked.

Failure to follow instructions specified by the manufacturer may result in serious consequences such as death, personal injury, or damage to equipment since the protection provided by the equipment may be impaired.

AVERTISSEMENT

FONCTIONNEMENT INATTENDU DE L'EQUIPEMENT

Dépouillez la longueur de la couche isolante du fil plus de 10mm pour assurer la connexion fiable du signal.

Le conducteur doit utiliser le fil de cuivre et le noyau de fil est supérieur ou égal à 0,2 mm², inférieur ou égal à 1mm², afin d'assurer la connexion fiable du signal.

Lorsque les terminaux de presse à froid sont terminés, ils doivent être terminés et visualisés en stricte conformité avec les spécifications ou les exigences correspondantes et terminés selon le numéro de série de noeud correspondant.

Il est interdit d'activer les bornes à froid avant qu'elles ne soient correctement articulées ou complètement verrouillées.

Le fait de ne pas suivre les instructions peut entraîner une défaillance de la protection fournie par l'équipement, ce qui peut entraîner des conséquences graves, comme des blessures ou des dommages à l'équipement.

DANGER

FIRE DANGER

Use the correct wiring rules only for the maximum current capacity of the I/O channel and power supply.

Failure to follow instructions specified by the manufacturer may result in serious consequences such as death, personal injury, or damage to equipment since the protection provided by the equipment may be impaired.

WARNING

UNEXPECTED EQUIPMENT OPERATION

Do not exceed any of the ratings specified in the environmental and electrical characteristics table.

Failure to follow instructions specified by the manufacturer may result in serious consequences such as death, personal injury, or damage to equipment since the protection provided by the equipment may be impaired.

 **AVERTISSEMENT**

FONCTIONNEMENT INATTENDU DE L'EQUIPEMENT

Ne dépassez aucune évaluation spécifiée dans le tableau de caractéristiques environnementales et électriques..

Le fait de ne pas suivre les instructions peut entraîner une défaillance de la protection fournie par l'équipement, ce qui peut entraîner des conséquences graves, comme des blessures ou des dommages à l'équipement.

4 Wiring

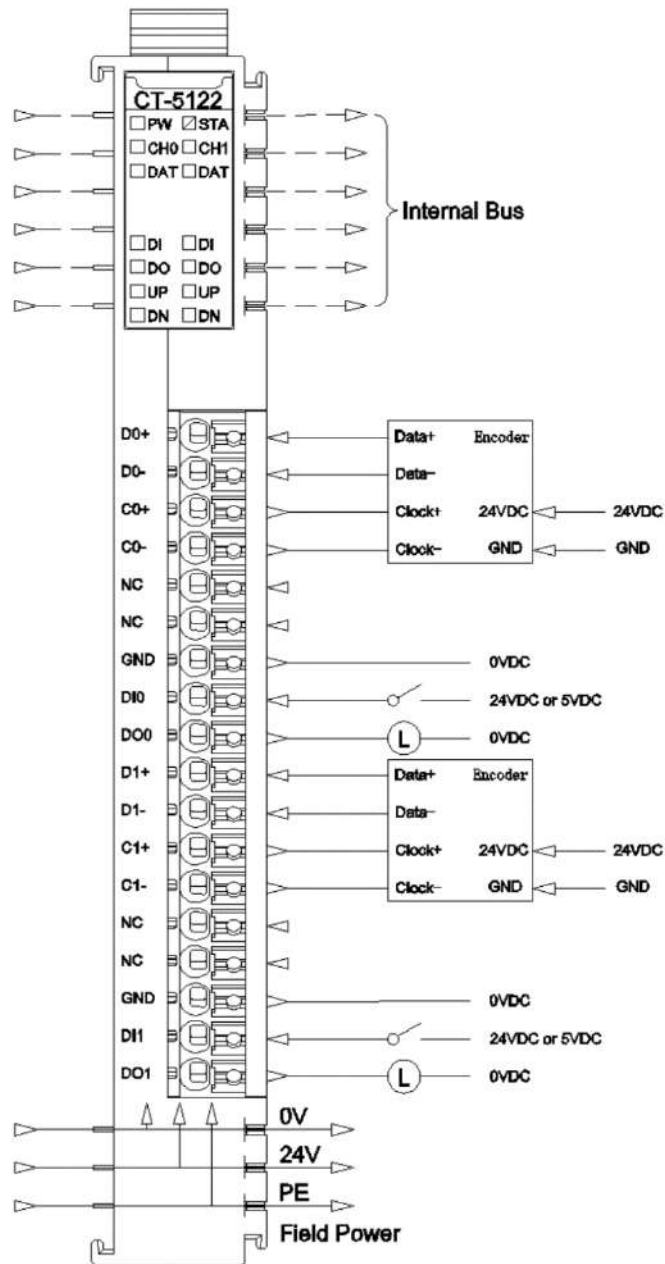

NOTICE

EQUIPMENT INOPERABLE

Do not crimp the spring terminal with more than the maximum pressure specified for the terminal. Otherwise, the resilience of the spring terminal may be damaged and the terminal rebound may be affected.

Do not press the spring terminal with a sharp tool when removing cable from the channel. Otherwise, the spring terminal will be damaged.

Failure to follow these instructions may result in equipment damage.

5 Process data definition

< 2 Analog Input (SSI Encoder) > Submodule process data definition

Input Data								
Bit No	Bit 7	Bit 6	Bit 5	Bit 4	Bit 3	Bit 2	Bit 1	Bit 0
Byte 0	Reserved				Encoder Count DOWN Ch#0	Encoder Count UP Ch#0	DI Ch#0	Data Line Status Ch#0
Byte 1	Reserved							
Byte 2	Reserved				Encoder Count DOWN Ch#1	Encoder Count UP Ch#1	DI Ch#1	Data Line Status Ch#1
Byte 3	Reserved							
Byte 4	Absolute Position Value Ch#0							
Byte 5								
Byte 6								
Byte 7								
Byte 8	Capture Position value Ch#0							
Byte 9								
Byte 10								
Byte 11								
Byte 12	Absolute Position Value Ch#1							
Byte 13								
Byte 14								
Byte 15								
Byte 16	Capture Position value Ch#1							
Byte 17								
Byte 18								
Byte 19								
Output Data								
Bit No	Bit 7	Bit 6	Bit 5	Bit 4	Bit 3	Bit 2	Bit 1	Bit 0
Byte 0	Reserved							DO Ch#0
Byte 1	Reserved							
Byte 2	Reserved							DO Ch#1
Byte 3	Reserved							

Data description:

Data Line Status Ch#(0-1): Indicates the idle status of the Data line of the corresponding channel (Normally, idle data is high level. If the value is 0, the polarity of the input signal is reversed, and the polarity of the input signal line needs to be switched) .

0: Data line level is low when idle

1: Data line level is high when idle

DI Ch#(0-1): The position is 1 when the corresponding channel input signal is valid, and 0 when the input is invalid.

0: Input signal invalid

1: Input signal valid

Encoder Count UP Ch#(0-1): The encoder counts up and in positive rotation.

Encoder Count DOWN Ch#(0-1): The encoder counts down and in contrarotation.

Absolute Position Value Ch#(0-1): Absolute position value, 32-bit signed integer, automatically clear after overflow.

Capture Position value Ch#(0-1): Capture position value, 32-bit signed integer, When DI is set to capture, the pulse meter value is captured to the pulse capture value at the selected edge.

DO Ch#(0-1): The position is 1 when the corresponding channel output signal is valid, and 0 when the output is invalid.

0: Output signal invalid

1: Output signal valid

6 Configuration parameters definition

<2 Analog Input (SSI Encoder)> Submodule configuration parameter definition

Configuration Parameter								
Bit No	Bit 7	Bit 6	Bit 5	Bit 4	Bit 3	Bit 2	Bit 1	Bit 0
Byte 0	Reserved					16Bit Data Format	32Bit Data Format	
Byte 1	Reserved		Frame Bit Length Ch#0					
Byte 2	Reserved				SSI CLK Frequency Ch#0			
Byte 3	SSI Interval Time Ch#0							
Byte 4								
Byte 5	Reserved						Gray Conversion Ch#0	
Byte 6	Reserved		LSB Bit of Position Value Ch#0					
Byte 7	Reserved		MSB Bit of Position Value Ch#0					
Byte 8	Reserved						Counter Storage Ch#0	
Byte 9	Reserved						DI Function Selection Ch#0	
Byte 10	Reserved					Capture Mode Ch#0		
Byte 11 ... Byte 30	Reserved							
Byte 31	Reserved		Frame Bit Length Ch#1					
Byte 32	Reserved				SSI CLK Frequency Ch Ch#1			
Byte 33	SSI Interval Time Ch#1							
Byte 34								
Byte 35	Reserved						Gray Conversion Ch#1	
Byte 36	Reserved		LSB Bit of Position Value Ch#1					
Byte 37	Reserved		MSB Bit of Position Value Ch#1					
Byte 38	Reserved						Counter Storage Ch#1	
Byte 39	Reserved						DI Function Selection Ch#1	
Byte 40	Reserved					Capture Mode Ch#1		
Byte 41 ... Byte 60	Reserved							

Data description:

16Bit Data Format: Byte transfer order of channel state. (Default: 0)

0: A-B

1: B-A

32Bit Data Format: The byte transfer order of a channel count value. (Default: 0)

0: AB-CD

1: BA-DC

2: CD-AB

3: DC-BA

Frame Bit Length Ch#(0-1): SSI frame length of encoder. (Default value: 13)

The value ranges from 10 to 40.

SSI CLK Frequency Ch#(0-1): The clock frequency when data is read. (Default: 1)

0:125KHz

1: 250KHz

2: 500KH

3: 1.0MHz

4: 1.5MHz

5: 2.0MHz

SSI Interval Time Ch#(0-1): Interval time (unit: 100us) the value range could be set

1 ~ 65535.

Gray Conversion Ch#(0-1): Gray Code Conversion enabled (default: 1)

0: Disable

1: Enable

LSB Bit of Position Ch#(0-1): LSB bit number of position value. The value range is 0 ~ 39 (default: 0)

MSB Bit of Position Ch#(0-1): The MSB bit number of the position value. The value range is 1 ~ 40 (default: 12)

Counter Storage Ch#(0-1): Enable storage. When the storage function is enabled, the IO module will save the count value to the non-volatile memory in real time, and

load the last saved count value at the next power-on. (Default: 1)

0: Disable

1: Enable

DI Function Selection Ch#(0-1): DI function selection (Default: 0)

0: Normal DI function

1: Pulse capture function

Capture Mode Ch#(0-1): Capture mode (default: 0)

0: Rising edge capture

1: Falling edge capture

2: Double edge capture

WARNING

UNEXPECTED EQUIPMENT OPERATION

Signal loss occurs if the encoder SSI frame parameters are improperly set.

If the LSB bit number and MSB bit number parameters of the encoder position value are set improperly, the signal loss will occur.

If the encoder gray code parameter is set improperly, the signal loss will occur.

Failure to follow instructions specified by the manufacturer may result in serious consequences such as death, personal injury, or damage to equipment since the protection provided by the equipment may be impaired.

AVERTISSEMENT

FONCTIONNEMENT INATTENDU DE L'EQUIPEMENT

Si les paramètres du cadre SSI de l'encodeur ne sont pas réglés correctement, une perte de signal se produira.

La perte de signal se produira si les paramètres LSB bit number et MSB bit number de la valeur de position de l'encodeur ne sont pas réglés correctement.

Si les paramètres du code gris de l'encodeur ne sont pas réglés correctement, la perte de signal se produira.

Le fait de ne pas suivre les instructions peut entraîner une défaillance de la protection fournie par l'équipement, ce qui peut entraîner des conséquences graves, comme des blessures ou des dommages à l'équipement.

A Dimension drawing

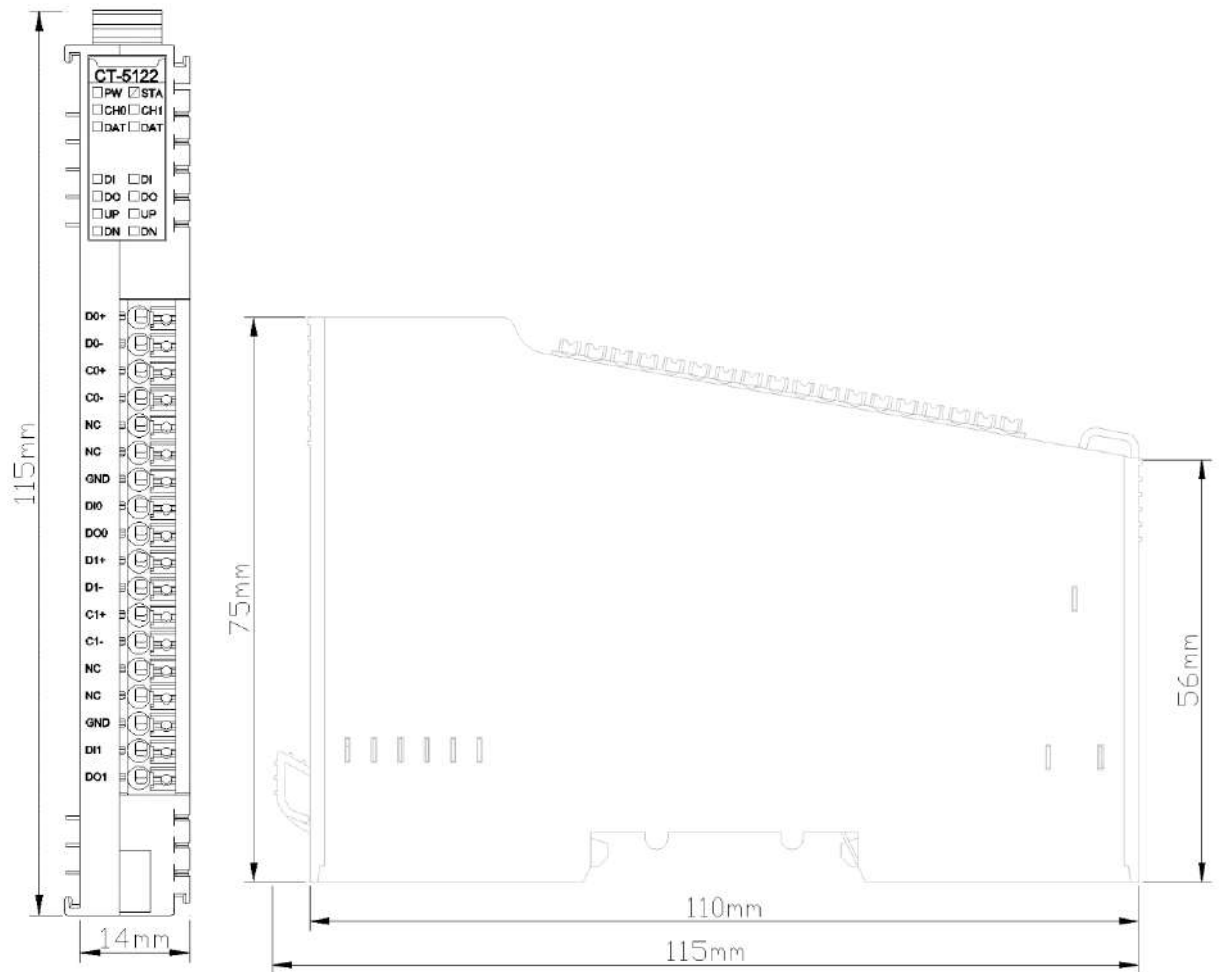

CT-5142 2-channels encoder /differential input

1 Module features

- ◆ The module supports two channels of encoder input.
- ◆ Each encoder channel supports A/B incremental encoder or pulse-directional encoder input.
- ◆ Each encoder channel supports orthogonal A/B differential signal input, voltage output range 0-5V.
- ◆ The incremental encoder mode supports x1/ x2 / x4 frequency multiplication mode.
- ◆ The pulse - direction mode supports nondirectional signal, pulse input only.
- ◆ Each encoder channel supports 1 digital input signal with an input voltage of 5Vdc or 24Vdc.
- ◆ Each encoder channel supports 1 digital output signal with an output voltage of 24Vdc.
- ◆ The module internal bus and field input adopt magnetic isolation.
- ◆ The module carries 16 LED indicators.
- ◆ The maximum input frequency of the encoder supported by the module is 10MHz.
- ◆ The module supports measurement function; it could detect the load speed or input signal frequency.

2 Technical parameters

General Parameters	
Power	Max.60mA@5.0Vdc
Isolation	I/O to internal bus: magnetic isolation (3KVrms)
Field Power	Nominal:24Vdc, Range:20.4-28.8Vdc
Wiring	Max.: AWG 18
Mounting Type	35mm DIN-Rail
Size	115*14*75mm
Weight	65g
Environment Specification	
Operating Temperature of Horizontal Installation	-35°C~70°C
Operating Temperature of Vertical Installation	-35°C~60°C
Relative Humidity	< 95%RH (No Condensation)
Storage Temperature	-40°C~85°C
Storage Humidity	< 95%RH (No Condensation)
Manufacturing Test Temperature	-40°C~75°C
Ingress Protection Rating	IP20
Input Parameters	
Channel Number	2-channel encoder
LED Indicator	16 channel input LED indicator
Encoder Signal Type	Differential input, voltage output range of 0-5V
Encoder Filtering Time	Default 0.5us
Encoder Count Frequency	<10MHz
Encoder Frequency Multiplication Mode	x1/x2/x4
Encoder Measurement Function	Load speed or input signal frequency measurement
DI Turn-on Voltage	Min.5Vdc to Max.28Vdc
DI Turn-off Voltage	Max.2.7Vdc
DI Turn-on Current	Max.5mA/ channel @28V
DI Input Impedance	>10.0kΩ
DI Input Delay	OFF to ON: Max.3ms ON to OFF: Max.2ms
DO Output Voltage	24V, range ±10%
DO Output Current	Max.500mA
DO Output Sink Current	Max.5uA

 **WARNING**

UNEXPECTED EQUIPMENT OPERATION

Do not exceed any of the ratings specified in the environmental and electrical characteristics table.

Failure to follow instructions specified by the manufacturer may result in serious consequences such as death, personal injury, or damage to equipment since the protection provided by the equipment may be impaired.

 **AVERTISSEMENT**

FONCTIONNEMENT INATTENDU DE L'EQUIPEMENT

Ne dépassez aucune évaluation spécifiée dans le tableau de caractéristiques environnementales et électriques..

Le fait de ne pas suivre les instructions peut entraîner une défaillance de la protection fournie par l'équipement, ce qui peut entraîner des conséquences graves, comme des blessures ou des dommages à l'équipement.

3 Hardware interfaces

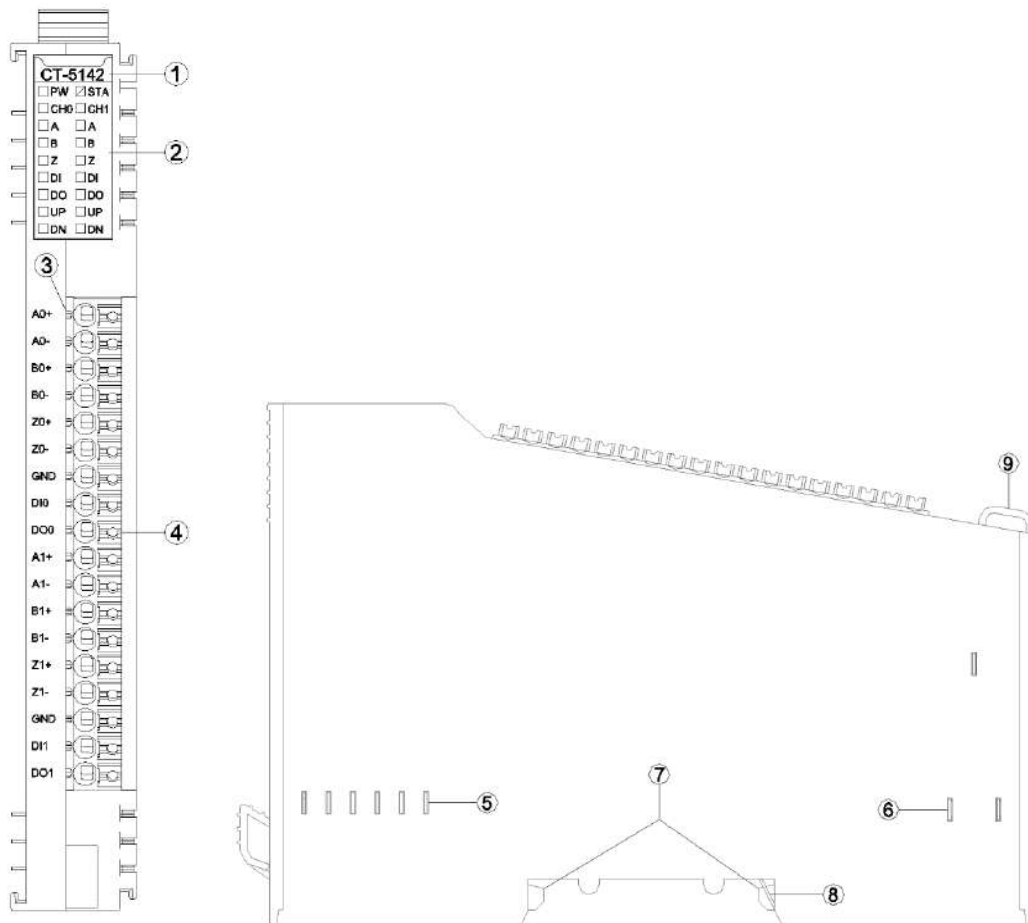

- ① Module Type
- ② State indicator
- ③ Channel indicator
- ④ Wiring Terminal and identification
- ⑤ Internal Bus
- ⑥ Field Power
- ⑦ Buckle
- ⑧ Grounding Spring Sheet

⑨ Fixed Wiring Harness

3.1 LED indicator definition

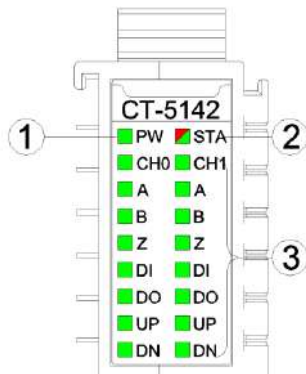

- ① Power LED indicator (green)
- ② Module State indicator LED (red/green)
- ③ Input channel indicator LED (green)

PW Power State	Definition
ON	Internal bus power supply normal
OFF	Internal bus power supply failure
STA Module State	Definition
Green slow flash (2.5 Hz)	Module internal bus is not started
Red slow flash (2.5 Hz)	Module internal bus offline
ON (GREEN)	Operation normal
Flash (2.5 Hz) (RED/GREEN)	updating mode
Flash (10 Hz) (RED/GREEN)	firmware update
Double Flash (RED)	Module exception has been soft-restarted
CH0 CH1 channel indicator LED	Definition
ON	Channel enable
A B Z Encoder signal indicator	Definition
ON	Input signal valid
OFF	Input signal invalid
DI input indicator	Definition
ON	Input signal high level
OFF	Input signal invalid
DO output indicator	Definition
ON	Output signal high level
OFF	Output signal invalid
UP indicator	Definition
ON	Encoder in positive rotation
OFF	Encoder is stationary or in contrarotation
DN indicator	Definition
ON	Encoder in contrarotation
OFF	Encoder is stationary or in positive rotation

 **WARNING****UNEXPECTED EQUIPMENT OPERATION**

By viewing the PW indicator, could determine the power supply status of a module. If the PW is steady green, the power supply is normal. Otherwise, the module cannot work properly.

When the module is initially powered on, there will be 3S for the backplane bus connection. After the backplane bus is initialized, STA is in the green steady state. If STA is in the green blinking state, it indicates that the backplane bus has not been initialized, and it needs to be powered off and restarted for re-initialization.

STA abnormal working state occurs during the normal operation of the module, please check the firmware version information of all modules, and consult ODOT technical support for details.

If a module is upgraded, check that all modules are in the normal state after the upgrade. Otherwise, an exception may occur.

Failure to follow instructions specified by the manufacturer may result in serious consequences such as death, personal injury, or damage to equipment since the protection provided by the equipment may be impaired.

 **AVERTISSEMENT****FONCTIONNEMENT INATTENDU DE L'EQUIPEMENT**

En regardant l'état de l'indicateur de PW, jugez l'état d'alimentation du module. Le feu vert PW reste allumé et l'alimentation est normale. Autrement, le module ne fonctionnera pas correctement.

Lorsque le module est alimenté initialement, il y aura 3S pour la connexion de bus de backboard. STA est un état vert permanent après l'initialisation du bus de backboard. Si STA est en état de clignotement vert, cela signifie que l'initialisation du bus de backboard n'est pas passée et doit être redémarrée hors tension et réinitialisée.

L'état de fonctionnement anormal de STA se produit pendant le fonctionnement normal du module, veuillez vérifier les informations de version du firmware de tous les modules, et consulter le support technique ODOT pour plus de détails.

Si le module a une opération de mise à niveau, après l'achèvement de la mise à niveau, le besoin de vérifier que tous les modules sont dans l'état normal avant de courir, sinon il conduira à une exception.

Le fait de ne pas suivre les instructions peut entraîner une défaillance de la protection fournie par l'équipement, ce qui peut entraîner des conséquences graves, comme des blessures ou des dommages à l'équipement.

3.2 Field channel LED indicator (Green)

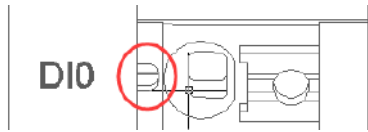

When the input signal of the input channel is valid, the corresponding field channel indicator is on (only the DI/DO wiring terminal of the encoder channel carries the indicator).

3.3 Terminal definition

Terminal Number	Symbol	Description
1	A0+	CH0 encoder phase A input +
2	A0-	CH0 encoder phase A input -
3	B0+	CH0 encoder phase B input +
4	B0-	CH0 encoder phase B input -
5	Z0+	CH0 encoder phase Z input +
6	Z0-	CH0 encoder phase Z input -
7	GND	Signal ground
8	DI0	CH0 digital signal input
9	DO0	CH0 digital signal output
10	A1+	CH1 encoder phase A input +
11	A1-	CH1 encoder phase A input -
12	B1+	CH1 encoder phase B input +
13	B1-	CH1 encoder phase B input -
14	Z1+	CH1 encoder phase Z input +
15	Z1-	CH1 encoder phase Z input -
16	GND	Signal ground
17	DI1	CH1 digital signal input
18	DO1	CH1 digital signal output

⚠ WARNING

UNEXPECTED EQUIPMENT OPERATION

Calculate the maximum field power current consumption of a single module based on the actual field load. If the total field power current consumption of all I/O modules exceeds the power supply capacity of the field power supply, you must add an extra power expansion module. Otherwise, an output channel exception may occur.

Failure to follow instructions specified by the manufacturer may result in serious consequences such as death, personal injury, or damage to equipment since the protection provided by the equipment may be impaired.

⚠️ AVERTISSEMENT

FONCTIONNEMENT INATTENDU DE L'EQUIPEMENT

Calculez la consommation maximale de courant de champ d'un seul module en fonction de la charge de champ réelle. Si la consommation totale de courant de champ de tous les modules d'E/S dépasse la capacité d'alimentation de l'alimentation de champ, vous devez ajouter un module d'extension de puissance supplémentaire. Dans le cas contraire, une exception de canal de sortie peut se produire.

Le fait de ne pas suivre les instructions peut entraîner une défaillance de la protection fournie par l'équipement, ce qui peut entraîner des conséquences graves, comme des blessures ou des dommages à l'équipement.

When connecting a cold-pressed terminal, the terminal must be terminated and checked in strict accordance with the corresponding termination specifications or requirements, and connect the cold-pressed terminal according to the corresponding node serial number. The conductor should use copper conductor and the conductor core should be larger than 0.2mm^2 and smaller than 1mm^2 (AWG18~AWG24). Cold-pressed terminal parameters are as follows:

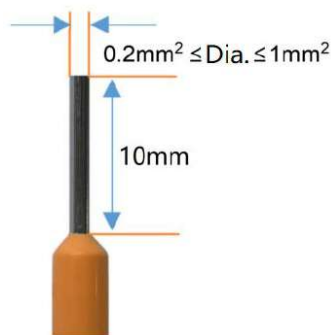

⚠️ WARNING

UNEXPECTED EQUIPMENT OPERATION

Strip the length of the conductor insulation layer is greater than 10mm to ensure reliable signal connection.

The wire needs to use copper wire and the wire core is greater than or equal to 0.2mm^2 and less than or equal to 1mm^2 to ensure reliable signal connection.

When connecting a cold-press terminal, connect the cold-press terminal strictly in accordance with the corresponding termination specifications or requirements, and connect the cold-press terminal according to the corresponding node serial number.

Do not power on cold-press terminals until they are properly connected or fully locked.

Failure to follow instructions specified by the manufacturer may result in serious

consequences such as death, personal injury, or damage to equipment since the protection provided by the equipment may be impaired.

AVERTISSEMENT

FONCTIONNEMENT INATTENDU DE L'EQUIPEMENT

Dépouillez la longueur de la couche isolante du fil plus de 10mm pour assurer la connexion fiable du signal.

Le conducteur doit utiliser le fil de cuivre et le noyau de fil est supérieur ou égal à 0,2 mm², inférieur ou égal à 1mm², afin d'assurer la connexion fiable du signal.

Lorsque les terminaux de presse à froid sont terminés, ils doivent être terminés et visualisés en stricte conformité avec les spécifications ou les exigences correspondantes et terminés selon le numéro de série de noeud correspondant.

Il est interdit d'activer les bornes à froid avant qu'elles ne soient correctement articulées ou complètement verrouillées.

Le fait de ne pas suivre les instructions peut entraîner une défaillance de la protection fournie par l'équipement, ce qui peut entraîner des conséquences graves, comme des blessures ou des dommages à l'équipement.

DANGER

FIRE DANGER

Use the correct wiring rules only for the maximum current capacity of the I/O channel and power supply.

Failure to follow instructions specified by the manufacturer may result in serious consequences such as death, personal injury, or damage to equipment since the protection provided by the equipment may be impaired.

WARNING

UNEXPECTED EQUIPMENT OPERATION

Do not exceed any of the ratings specified in the environmental and electrical characteristics table.

Failure to follow instructions specified by the manufacturer may result in serious consequences such as death, personal injury, or damage to equipment since the protection provided by the equipment may be impaired.

AVERTISSEMENT

FONCTIONNEMENT INATTENDU DE L'EQUIPEMENT

Ne dépassez aucune évaluation spécifiée dans le tableau de caractéristiques environnementales et électriques..

Le fait de ne pas suivre les instructions peut entraîner une défaillance de la protection fournie par l'équipement, ce qui peut entraîner des conséquences graves, comme des blessures ou des dommages à l'équipement.

4 Wiring

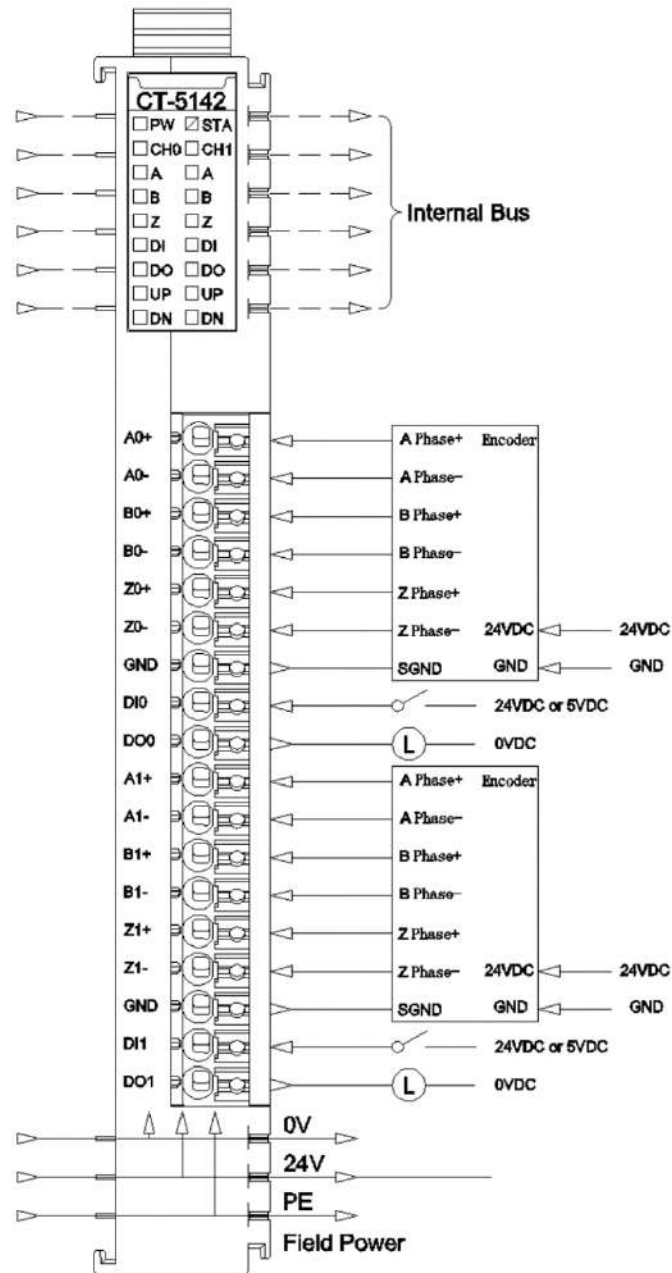

NOTICE

EQUIPMENT INOPERABLE

Do not crimp the spring terminal with more than the maximum pressure specified for the terminal. Otherwise, the resilience of the spring terminal may be damaged and the terminal rebound may be affected.

Do not press the spring terminal with a sharp tool when removing cable from the channel. Otherwise, the spring terminal will be damaged.

Failure to follow these instructions may result in equipment damage.

5 Process data definition

< 2 Analog Input (Encoder) > Submodule process data definition

Input Data								
Bit No	Bit 7	Bit 6	Bit 5	Bit 4	Bit 3	Bit 2	Bit 1	Bit 0
Byte 0	Counter DOWN Ch#0	Counter UP Ch#0	Counter Underflow Ch#0	Counter Overflow Ch#0	DI Ch#0	Z Ch#0	B Ch#0	A Ch#0
Byte 1	Reserved							
Byte 2	Counter DOWN Ch#1	Counter UP Ch#1	Counter Underflow Ch#1	Counter Overflow Ch#1	DI Ch#1	Z Ch#1	B Ch#1	A Ch#1
Byte 3	Reserved							
Byte 4	Counter value Ch#0							
Byte 5								
Byte 6								
Byte 7								
Byte 8	Capture value Ch#0							
Byte 9								
Byte 10								
Byte 11								
Byte 12	Measurements 1 Ch#0							
Byte 13								
Byte 14								
Byte 15								
Byte 16	Measurements 2 Ch#0							
Byte 17								
Byte 18								
Byte 19								
Byte 20	Counter value Ch#1							
Byte 21								
Byte 22								
Byte 23								
Byte 24	Capture value Ch#1							
Byte 25								
Byte 26								
Byte 27								
Byte 28	Measurements 1 Ch#1							
Byte 29								
Byte 30								
Byte 31								
Byte 32	Measurements 2 Ch#1							
Byte 33								
Byte 34								
Byte 35								
Output Data								
Bit No	Bit 7	Bit 6	Bit 5	Bit 4	Bit 3	Bit 2	Bit 1	Bit 0

Byte 0	Reserved	Flow Clear Ch#0	Counter Set Trigger Ch#0	DO Ch#0
Byte 1	Reserved			
Byte 2	Reserved	Flow Clear Ch#1	Counter Set Trigger Ch#1	DO Ch#1
Byte 3	Reserved			
Byte 4	Set Value for Counter Ch#0			
Byte 5				
Byte 6				
Byte 7				
Byte 8	Set Value for Counter Ch#1			
Byte 9				
Byte 10				
Byte 11				

Data description:

Input data definition:

A/B/Z Ch#(0-1): The position is 1 when the corresponding channel A/B/Z input signal is valid, and 0 when the input is invalid.

DI Ch#(0-1): Digital input signal status.

Counter Overflow Ch#(0-1): Counter overflowed flag bit.

Counter Underflow Ch#(0-1): Counter underflows flag bit.

Counter UP: Encoder positive rotation, counter up counting sign.

Counter DOWN: Encoder contrarotation, counter down count flag.

Counter Value Ch#(0-1): Pulse count value, 32 - bit signed integer, automatically clear after overflow.

Capture value Ch#(0-1): Pulse capture value, 32-bit signed integer, and when DI is set to capture, the pulse count value will be captured to the capture value at the selected edge.

Measurements 1 Ch#(0-1): Measurement value 1, the measurement value will be output according to the measurement value type selected by the user (view the configuration parameter section of the module for optional measurement value)

Measurements 2 Ch#(0-1): Measurement value 2, the measurement value will be

output according to the measurement value type selected by the user (view the configuration parameter section of the module for optional measurement value)

Output data definition:

DO Ch#(0-1): Digital output channel control.

Counter Set Trigger CH#(0-1): Counter set trigger bit, rising edge trigger counter set, the output value **Set Value for Counter** will be updated to **Counter Value**, this function can be used to set the initial value of the counter.

Flow Clear CH#(0-1): Overflow clear bit, the rising edge can clear the input **Counter**

Overflow and **Counter Underflow** flag bits.

Set Value for Counter Ch#(0-1): Counter set value.

6 Configuration parameters definition

<2 Analog Input (Encoder) > Submodule configuration parameter definition

Configuration Parameter								
Bit No	Bit 7	Bit 6	Bit 5	Bit 4	Bit 3	Bit 2	Bit 1	Bit 0
Byte 0	Reserved					16Bit Data Format	32Bit Data Format	
Byte 1	Reserved					Work Mode Ch#0		
Byte 2	Reserved						Frequency Multiplication Ch#0	
Byte 3	Reserved			Filtering Time Ch#0				
Byte 4	Reserved							Counter Storage Ch#0
Byte 5	Reserved							DI Function Selection Ch#0
Byte 6	Reserved						Capture Mode Ch#0	
Byte 7 ... Byte 16	Reserved							
Byte 17	Reserved					Speed Measurement Time Ch#0		
Byte 18	Reserved	Measurements 2 Type Ch#0			Measurements 1 Type Ch#0			
Byte 19	Encoder Resolution Ch#0							
Byte 20								
Byte 21	Transmission Ratio Active Ch#0							
Byte 22								
Byte 23	Transmission Ratio Slave Ch#0							
Byte 24								
Byte 25 ... Byte 32	Reserved							
Byte 33	Reserved					Work Mode Ch#1		
Byte 34	Reserved						Frequency Multiplication Ch#1	
Byte 35	Reserved			Filtering Time Ch#1				
Byte 36	Reserved							Counter Storage Ch#1
Byte 37	Reserved							DI Function Selection Ch#1
Byte 38	Reserved						Capture Mode Ch#1	

Byte 39 ... Byte 48	Reserved		
Byte 49	Reserved		Speed Measurement Time Ch#1
Byte 50	Reserved	Measurements 2 Type Ch#1	Measurements 1 Type Ch#1
Byte 51	Encoder Resolution Ch#1		
Byte 52			
Byte 53	Transmission Ratio Active Ch#1		
Byte 54			
Byte 55	Transmission Ratio Slave Ch#1		
Byte 56			
Byte 57 ... Byte 64	Reserved		

Data description:

16Bit Data Format: Byte transfer order of channel state. (Default: 0)

- 0: A-B
- 1: B-A

32Bit Data Format: The byte transfer order of a channel count value. (Default: 0)

- 0: AB-CD
- 1: BA-DC
- 2: CD-AB
- 3: DC-BA

Work Mode Ch#(0-1): Working mode of encoder. (Default: 0)

- 0: Incremental encoder mode.
- 1: Count direction mode.
- 2: Count up mode.
- 3: Count down mode.

Frequency Multiplication Ch#(0-1): Frequency multiplication number (available only in incremental encoder mode), according to this mode it could output pulse count value. (Default: 2)

- 0: frequency multiplication 1
- 1: frequency multiplication 2
- 2: frequency multiplication 4

Filtering Time Ch#(0-1): Encoder input filter time (default: 5)

0: no filter

1: 0.1uS

...

5: 0.5 uS

...

31: 3.1 uS

Counter Storage Ch#(0-1): Enable storage. When the storage function is enabled, the IO module will save the count value to the non-volatile memory in real time, and load the last saved count value at the next power-on. (Default: 1)

0: Disable

1: Enable

DI Function Selection Ch#(0-1): DI function selection (Default: 0)

0: Normal DI function

1: Pulse capture function

Capture Mode Ch#(0-1): Capture mode (default: 0)

0: Rising edge capture

1: Falling edge capture

2: Double edge capture

Speed Measurement Time Ch#(0-1): Speed measurement period (Default: 6)

0: 10mS

1: 20mS

2: 50mS

3: 100mS

4: 200mS

5: 500mS

6: 1000mS

7: 2000mS

Measurements 1 Type Ch#(0-1): Measurement value 1 Type selection (default: 0)

- 0: No measurements
- 1: Measuring speed (min/rotation)
- 2: Measuring frequency

Measurements 2 Type Ch#(0-1): Measurement value 2 Type selection (default: 0)

- 0: No measurements
- 1: Measuring speed (min/ rotation)
- 2: Measuring frequency

Encoder Resolution Ch#(0-1): Encoder resolution (default: 1)

Value range: 1-65535

Transmission Ratio Active Ch#(0-1): 1) Transmission ratio (main) (Default: 1)

Value range: 1-65535

Transmission Ratio Slave Ch#(0-1): Transmission ratio (main) (Default: 1)

Value range: 1-65535

A Dimension drawing

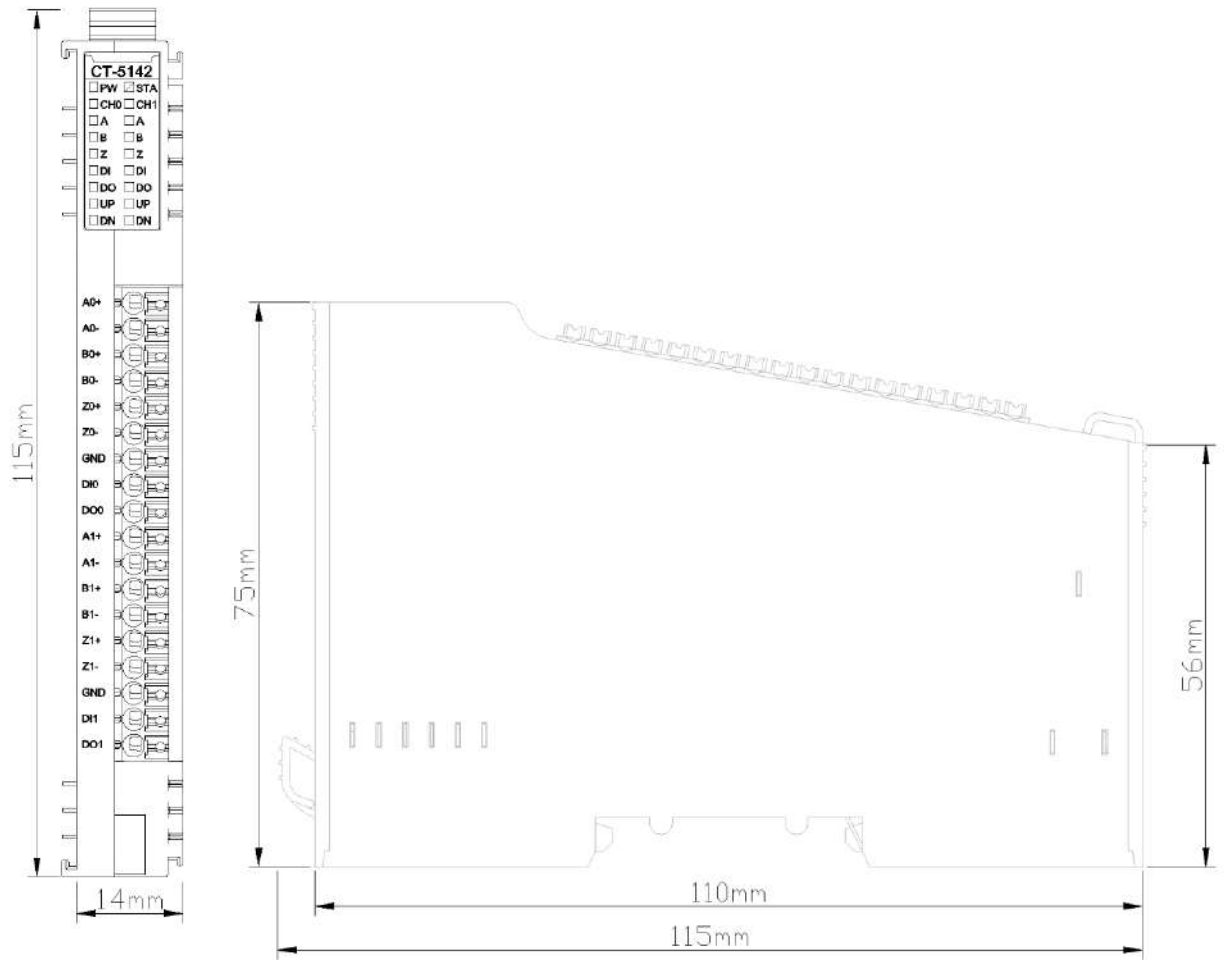

CT-5212 8-channel digital input &2-channel digital output &2-channel PWM output

1 Module features

- ◆ The module supports 8-channel digital input, the input high level is valid, it could support PNP sensor.
- ◆ The module supports 2-channel digital output, the output high level is valid.
- ◆ The module supports 2-channel PWM output, the duty circle is adjustable.
- ◆ The module supports short circuit protection and overcurrent protection.

2 Technical parameters

General parameter	
Field Power	Supply: 20.4-28.8VDC (Nominal: 24VDC, Pulsation within 5%) Protection: Anti-reverse connection protection
Power	Max.60mA@5.0VDC
Isolation	The isolation voltage between field power and system power is AC500V The isolation voltage between I/O channel and system power is AC500V The isolation voltage between I/O channel and PE is AC500V
Wiring	Max.: AWG 18 Min.: AWG 24
Mounting Type	35mm DIN-Rail
Size	115*14*75mm
Weight	65g
Environment parameter	
Operation Temperature	-35~60°C
Environment Humidity	5%~95% No condensation
Ingress Protection Rating	IP20
DI Parameter	
Channel Number	8-channel input
Indicator	8-channel input indicator
Input Type	IEC61131-2 type3
Turn-on Voltage	Sink: 11~30VDC (compared with COM terminal)
Turn-off Voltage	Sink: -3~5VDC (compared with COM terminal)
Turn-on Current	2.5mA@DC11V, Comply with IEC61131, type 3
Input Impedance	>1K Ω @DC24V
Output Delay	OFF to ON:<1ms ON to OFF<1ms
Filter Time	Default: 8us
Sample Frequency	Max.1KHz
DO Parameter	
Channel Number	2-channel output
Indicator	2-channel output indicator
Rated Current	Max.0.5A
Leakage Current	<350uA
On-resistance	Typical value: 540m Ω
Output Delay	OFF to ON:<5us ON to OFF<10us
Output Type	Source output/high level output
Load Type	General use and Resistive
Protection Function	Short-circuit protection Overcurrent protection: 1.6A Over-temperature protection: thermal protection temperature of the channel: 167°C Thermal protection temperature of the chip: 150°C
Pulse output parameter	
Channel Number	2-channel output

Rated Current	Max.0.5A
Leakage Current	<350uA
On-resistance	Typical: 540m Ω
Output Delay	OFF to ON:<1us ON to OFF<1us
Pulse Duration Accuracy	±0.5us
Minimum Pulse Duration	2.5us
Maximum Switching Frequency	200KHz
Pulse Rise Rime	<300ns
Pulse Decay Time	<100ns
Protection Function	Short-circuit protection Overcurrent protection: 1.6A 过温保护: 通道热保护温度: 167℃ 芯片热保护温度: 150℃
EMC 参数	
Static	Air 8KV
EFT	Power 2KV, Signal 1KV
Surge	Common mode 2KV, Differential mode1KV

WARNING

UNEXPECTED EQUIPMENT OPERATION

Do not exceed any of the ratings specified in the environmental and electrical characteristics table.

Failure to follow instructions specified by the manufacturer may result in serious consequences such as death, personal injury, or damage to equipment since the protection provided by the equipment may be impaired.

AVERTISSEMENT

FONCTIONNEMENT INATTENDU DE L'EQUIPEMENT

Ne dépassez aucune évaluation spécifiée dans le tableau de caractéristiques environnementales et électriques..

Le fait de ne pas suivre les instructions peut entraîner une défaillance de la protection fournie par l'équipement, ce qui peut entraîner des conséquences graves, comme des blessures ou des dommages à l'équipement.

3 Hardware interfaces

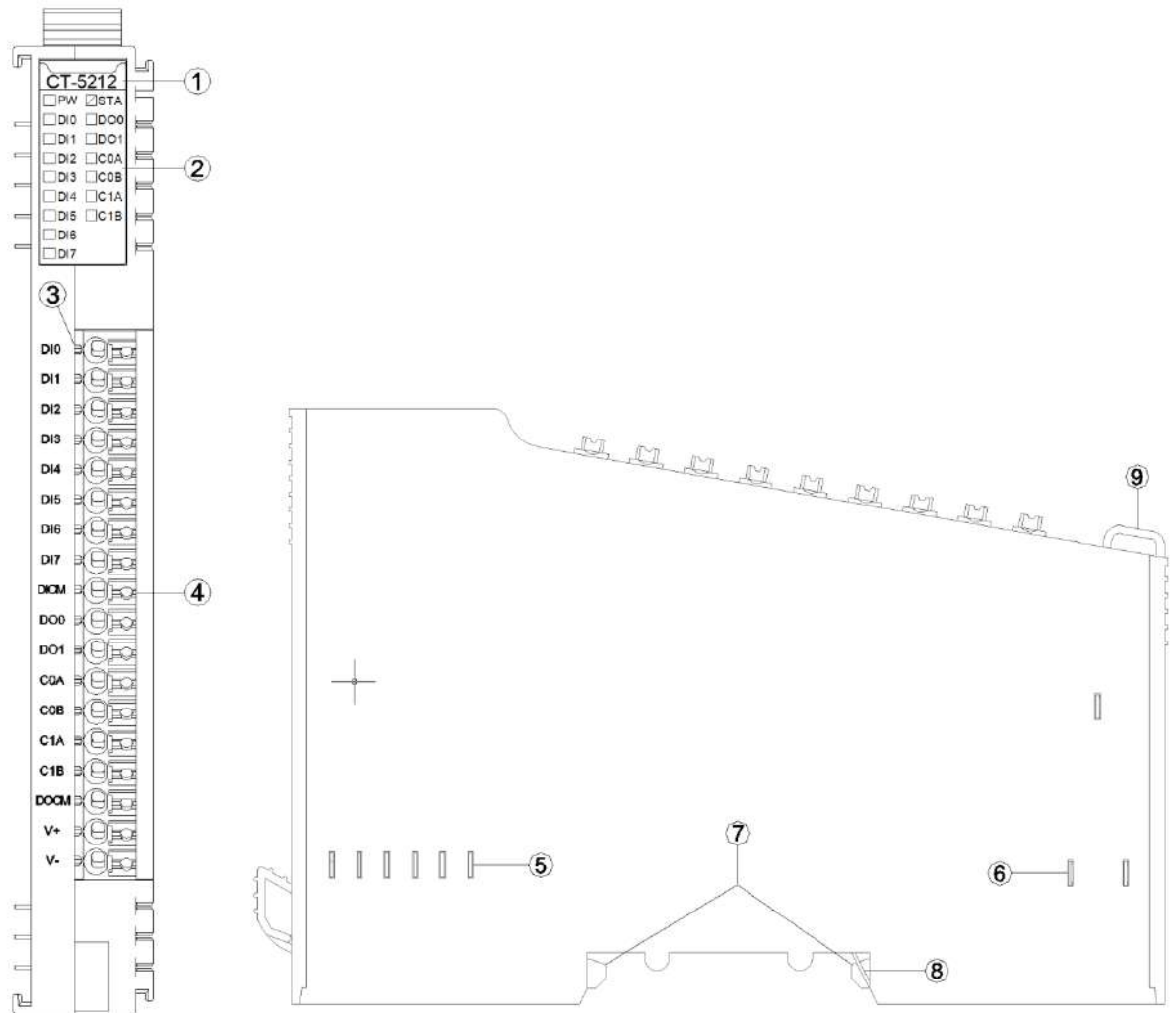

- ① module type
- ② state indicator
- ③ Field channel indicator
- ④ Wiring Terminal and identification
- ⑤ internal bus
- ⑥ field power
- ⑦ buckle
- ⑧ Grounding Spring Sheet
- ⑨ Fixed Wiring Harness

3.1 LED indicator definition

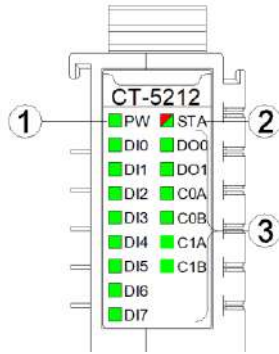

- ① Power indicator (GREEN)
- ② Module state indicator (RED/GREEN)
- ③ Output channel indicator (GREEN)

PW Power indicator (GREEN)	Definition
ON	Internal bus supply normal
OFF	Internal bus supply abnormal
STA module state indicator (RED/GREEN)	Definition
Slow flash (GREEN) (2.5Hz)	Module internal bus is not started
Slow flash (RED) (2.5Hz)	Module internal bus offline
ON (GREEN)	Operation normal
Flash (RED/GREEN) (2.5Hz)	updating mode
Flash (RED/GREEN) (10Hz)	firmware update
Double flash (RED)	Module exception has been soft-restarted
D10~7 Input channel indicator (GREEN)	Definition
ON	The digital input signal is valid
OFF	The digital input signal is invalid
DO0~1 output channel indicator (GREEN)	Definition
ON	The digital output signal is valid
OFF	The digital output signal is valid
C0A~C1A output channel indicator (GREEN)	Definition
ON	The PWM output signal valid
OFF	The PWM output signal invalid

WARNING

UNEXPECTED EQUIPMENT OPERATION

Strip the length of the conductor insulation layer is greater than 10mm to ensure reliable signal connection.

The wire needs to use copper wire and the wire core is greater than or equal to 0.2mm² and less than or equal to 1mm² to ensure reliable signal connection.

When connecting a cold-press terminal, connect the cold-press terminal strictly in accordance with the corresponding termination specifications or requirements, and connect the cold-press terminal according to the corresponding node serial number.

Do not power on cold-press terminals until they are properly connected or fully locked.

Failure to follow instructions specified by the manufacturer may result in serious consequences such as death, personal injury, or damage to equipment since the protection provided by the equipment may be impaired.

AVERTISSEMENT

FONCTIONNEMENT INATTENDU DE L'EQUIPEMENT

Dépouillez la longueur de la couche isolante du fil plus de 10mm pour assurer la connexion fiable du signal.

Le conducteur doit utiliser le fil de cuivre et le noyau de fil est supérieur ou égal à 0,2 mm², inférieur ou égal à 1mm², afin d'assurer la connexion fiable du signal.

Lorsque les terminaux de presse à froid sont terminés, ils doivent être terminés et visualisés en stricte conformité avec les spécifications ou les exigences correspondantes et terminés selon le numéro de série de noeud correspondant.

Il est interdit d'activer les bornes à froid avant qu'elles ne soient correctement articulées ou complètement verrouillées.

Le fait de ne pas suivre les instructions peut entraîner une défaillance de la protection fournie par l'équipement, ce qui peut entraîner des conséquences graves, comme des blessures ou des dommages à l'équipement.

3.2 Terminal definition

No.	Definition	Instruction
1	DI0	Digital input
2	DI1	
3	DI2	
4	DI3	
5	DI4	
6	DI5	
7	DI6	
8	DI7	
9	DI8	
10	DICM	Digital input common terminal
11	DO0	Digital output
12	DO1	
13	C0A	PWM output
14	C0B	
15	C1A	
16	C1B	
17	DOCM	Digital output common terminal
18	V+	Power input (note 1)
19	V-	

Note 1: The power supply of the DI circuit may or may not be the same origin as the power supply of V+ and V-.

WARNING

UNEXPECTED EQUIPMENT OPERATION

Calculate the maximum field power current consumption of a single module based on the actual field load. If the total field power current consumption of all I/O modules exceeds the power supply capacity of the field power supply, you must add an extra power expansion module. Otherwise, an output channel exception may occur.

Failure to follow instructions specified by the manufacturer may result in serious consequences such as death, personal injury, or damage to equipment since the protection provided by the equipment may be impaired.

AVERTISSEMENT

FONCTIONNEMENT INATTENDU DE L'EQUIPEMENT

Calculez la consommation maximale de courant de champ d'un seul module en fonction de la charge

de champ réelle. Si la consommation totale de courant de champ de tous les modules d'E/S dépasse la capacité d'alimentation de l'alimentation de champ, vous devez ajouter un module d'extension de puissance supplémentaire. Dans le cas contraire, une exception de canal de sortie peut se produire.

Le fait de ne pas suivre les instructions peut entraîner une défaillance de la protection fournie par l'équipement, ce qui peut entraîner des conséquences graves, comme des blessures ou des dommages à l'équipement.

When connecting a cold-pressed terminal, the terminal must be terminated and checked in strict accordance with the corresponding termination specifications or requirements, and connect the cold-pressed terminal according to the corresponding node serial number. The conductor should use copper conductor and the conductor core should be larger than 0.2mm^2 and smaller than 1mm^2 (AWG18~AWG24). Cold-pressed terminal parameters are as follows:

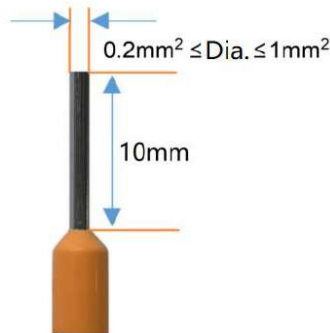

! WARNING

UNEXPECTED EQUIPMENT OPERATION

Strip the length of the conductor insulation layer is greater than 10mm to ensure reliable signal connection.

The wire needs to use copper wire and the wire core is greater than or equal to 0.2mm^2 and less than or equal to 1mm^2 to ensure reliable signal connection.

When connecting a cold-press terminal, connect the cold-press terminal strictly in accordance with the corresponding termination specifications or requirements, and connect the cold-press terminal according to the corresponding node serial number.

Do not power on cold-press terminals until they are properly connected or fully locked.

Failure to follow instructions specified by the manufacturer may result in serious consequences such as death, personal injury, or damage to equipment since the protection provided by the equipment may be impaired.

! AVERTISSEMENT

FONCTIONNEMENT INATTENDU DE L'EQUIPEMENT

Dépouillez la longueur de la couche isolante du fil plus de 10mm pour assurer la connexion fiable du signal.

Le conducteur doit utiliser le fil de cuivre et le noyau de fil est supérieur ou égal à 0,2 mm², inférieur ou égal à 1mm², afin d'assurer la connexion fiable du signal.

Lorsque les terminaux de presse à froid sont terminés, ils doivent être terminés et visualisés en stricte conformité avec les spécifications ou les exigences correspondantes et terminés selon le numéro de série de noeud correspondant.

Il est interdit d'activer les bornes à froid avant qu'elles ne soient correctement articulées ou complètement verrouillées.

Le fait de ne pas suivre les instructions peut entraîner une défaillance de la protection fournie par l'équipement, ce qui peut entraîner des conséquences graves, comme des blessures ou des dommages à l'équipement.

DANGER

FIRE DANGER

Use the correct wiring rules only for the maximum current capacity of the I/O channel and power supply.

Failure to follow instructions specified by the manufacturer may result in serious consequences such as death, personal injury, or damage to equipment since the protection provided by the equipment may be impaired.

WARNING

UNEXPECTED EQUIPMENT OPERATION

Do not exceed any of the ratings specified in the environmental and electrical characteristics table.

Failure to follow instructions specified by the manufacturer may result in serious consequences such as death, personal injury, or damage to equipment since the protection provided by the equipment may be impaired.

AVERTISSEMENT

FONCTIONNEMENT INATTENDU DE L'EQUIPEMENT

Ne dépassez aucune évaluation spécifiée dans le tableau de caractéristiques environnementales et électriques..

Le fait de ne pas suivre les instructions peut entraîner une défaillance de la protection fournie par l'équipement, ce qui peut entraîner des conséquences graves, comme des blessures ou des dommages à l'équipement.

4 Wiring

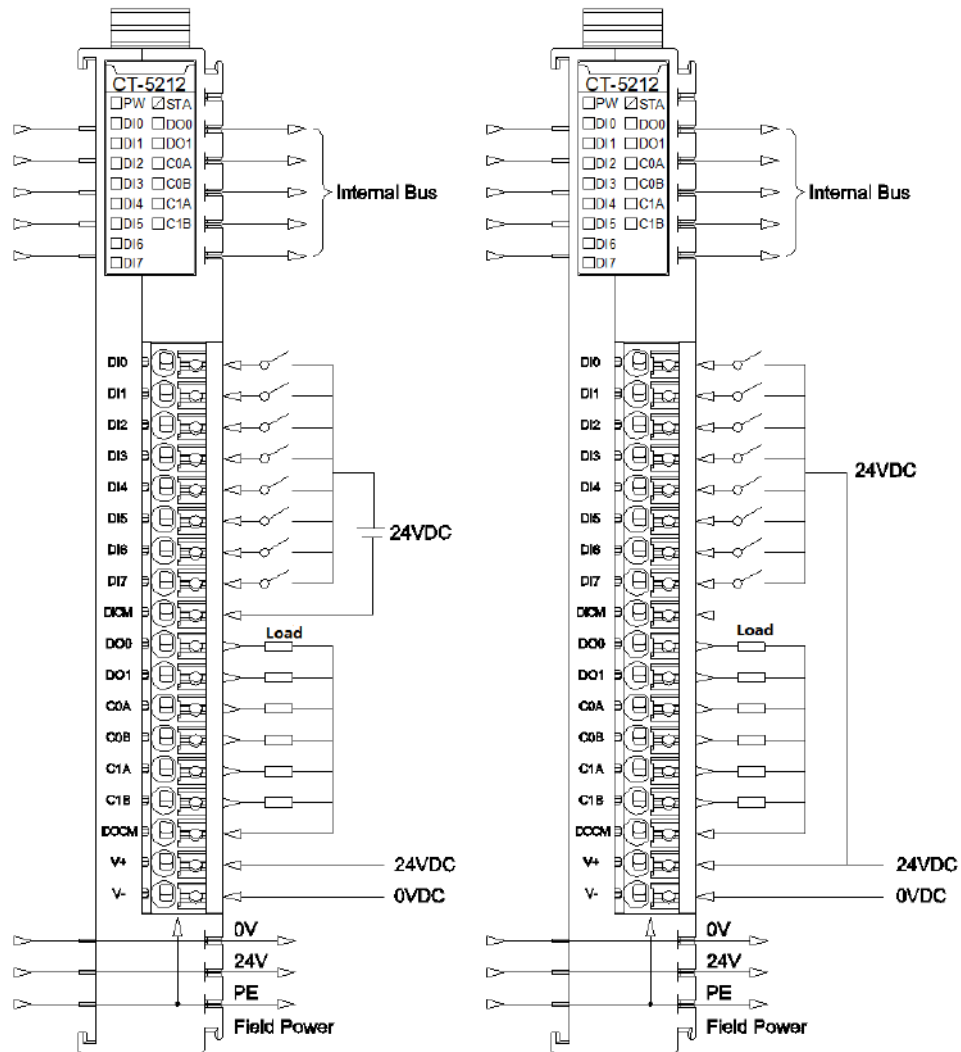

NOTICE

EQUIPMENT INOPERABLE

Do not crimp the spring terminal with more than the maximum pressure specified for the terminal. Otherwise, the resilience of the spring terminal may be damaged and the terminal rebound may be affected.

Do not press the spring terminal with a sharp tool when removing cable from the channel. Otherwise, the spring terminal will be damaged.

Failure to follow these instructions may result in equipment damage.

5 Process data definition

Input data								
Bit No	Bit 7	Bit 6	Bit 5	Bit 4	Bit 3	Bit 2	Bit 1	Bit 0
Byte 0	Pulse_Status_Flag (CH0)							
Byte 1	Pulse_Status_Flag (CH1)							
Byte 2	Speed_Reached Ch#0	Position_Reach Ch#0	Zero_return_completed Ch#0	Inching_mode_status Ch#0	Speed_mode_status Ch#0	Location_mode_status Ch#0	Return_to_zero_state Ch#0	Pulse_Output_direction Ch#0
Byte 3	UNUS ED Ch#0	UNUS ED Ch#0	UNUS ED Ch#0	UNUS ED Ch#0	DI3_signal Ch#0	DI2_signal Ch#0	DI1_signal Ch#0	DI0_signal Ch#0
Byte 4	Speed_Reached Ch#1	Position_Reach Ch#1	Zero_return_completed Ch#1	Inching_mode_status Ch#1	Speed_mode_status Ch#1	Location_mode_status Ch#1	Return_to_zero_state Ch#1	Pulse_Output_direction Ch#1
Byte 5	UNUS ED Ch#1	UNUS ED Ch#1	UNUS ED Ch#1	UNUS ED Ch#1	DI3_signal Ch#1	DI2_signal Ch#1	DI1_signal Ch#1	DI0_signal Ch#1
Byte 6	Error_Status Ch#0							
Byte 7								
Byte 8	Error_Status Ch#1							
Byte 9								
Byte 10	Current_location Ch#0							
Byte 11								
Byte 12								
Byte 13								
Byte 14	Current_speed Ch#0							
Byte 15								
Byte 16								
Byte 17								
Byte 18	Current_location Ch#1							
Byte 19								
Byte 20								
Byte 21								
Byte 22	Current_speed Ch#1							
Byte 23								
Byte 24								
Byte 25								

Data description:

Pulse_Status_Flag Ch#(0-1): Reflects the current pulse status flag

00: Pulseless output

01: Accelerating

10: Decelerating

11: Constant speed

Pulse_Output_direction Ch#(0-1): Pulse actual output direction

0: Forward

1: Reverse

Return_to_zero_state Ch#(0-1): Return to zero state

0: Out of the return to zero state

1: In return to zero state

Location_Mode_status Ch#(0-1):Location mode running status.

0: Out of the location mode status

1: In location mode status

Speed_mode_status Ch#(0-1):Speed mode running status

0: Out of the speed mode status

1: In speed mode status

Inching_mode_status Ch#(0-1):Inching mode status running status

0: Out of the inching mode status

1: In inching mode status

Zero_return_completed Ch#(0-1): Return to zero completed

0: Return to zero not completed

1: Return to zero completed

Position_Reach Ch#(0-1):Position reached

0: Position unreached

1: Position reached

Speed_reached Ch#(0-1):Speed reached

0: Speed unreached

1: Speed reached

DI(n)_signal Ch#(0-1):Channel input signal

0: No signal input

1: Signal input

Error_Status Ch#(0-1): Error code

0x0001: Starting speed > Return to zero approach velocity

0x0002: The number of run steps is incorrect (Position×Unit pulse number >2³²)

0x0004: Zero return speed error (Speed>200000)

0x0010: Return to zero approach speed error (Speed >200000)

0x0020: Running speed error (Speed×>200000)

0x0040: The point running speed is incorrect (Speed >200000)

0x0080: Acceleration time error (20~5000ms)

0x0100: Slow down time error (20~5000ms)

0x0200: Positive limit trigger, no further forward movement allowed

0x0400: Negative limit trigger, no further negative movement allowed

0x0800: The pulse output channel is faulty

Current_location Ch#(0-1): current location (signed32)

Current_speed Ch#(0-1): current speed (signed32)

Output data								
Bit No	Bit 7	Bit 6	Bit 5	Bit 4	Bit 3	Bit 2	Bit 1	Bit 0
Byte 0	Sports_mode Ch#0							
Byte 1	Reverse_jog Ch#0	Forward_jog Ch#0	Starting_to_return_to_zero Ch#0	Emergency_stop_command Ch#0	Start_movement Ch#0	Current_coordinates Ch#0	Direction_movement Ch#0	DO_output Ch#0
Byte 2	Sports_mode Ch#1							
Byte 3	Reverse_jog Ch#1	Forward_jog Ch#1	Starting_to_return_to_zero Ch#1	Emergency_stop_command Ch#1	Start_movement Ch#1	Current_coordinates Ch#1	Direction_movement Ch#1	DO_output Ch#1

Byte 4	Speed_Reached Ch#1	Position_Reach Ch#1	Zero_return_completed Ch#1	Inching_mode_status Ch#1	Speed_mode_status Ch#1	Location_mode_status Ch#1	Return_to_zero_state Ch#1	Pulse_Output_direction Ch#1
Byte 6	Acceleration_time Ch#0							
Byte 7								
Byte 8	Deceleration_time Ch#0							
Byte 9								
Byte 10	Acceleration_time Ch#1							
Byte 11								
Byte 12	Deceleration_time Ch#1							
Byte 13								
Byte 14	Running_speed Ch#0							
Byte 15								
Byte 16								
Byte 17								
Byte 18	Running_steps Ch#0							
Byte 19								
Byte 20								
Byte 21								
Byte 22	Jog_speed Ch#0							
Byte 23								
Byte 24								
Byte 25								
Byte 14	Running_speed Ch#1							
Byte 15								
Byte 16								
Byte 17								
Byte 18	Running_steps Ch#1							
Byte 19								
Byte 20								
Byte 21								
Byte 22	Jog_speed Ch#1							
Byte 23								
Byte 24								
Byte 25								

Data description:

Sports_mode Ch#(0-1): sports mode

- 00: absolute position
- 01: relative position
- 10: speed mode
- 11: Inching mode

DO_output Ch#(0-1):DO output

- 0: no digital output
- 1: digital output

Direction_of_movement Ch#(0-1):direction of movement

0: Forward

1: Reverse

Current_coordinates Ch#(0-1):current coordinates return to zero.

Edge control: 0->1 zeroing current coordinates

Start_movement Ch#(0-1):start movement

Edge control: 0->1 start

Emergency_stop_command Ch#(0-1): Emergency stop command

0: no emergency stop command

1: Emergency stop command triggered

Starting_to_return_to_zero Ch#(0-1):return to zero command

Edge control: 0->1 start

Forward_jog Ch#(0-1):forward jog

0: start

1: stop

Reverse_jog Ch#(0-1):reverse jog

0: start

1: stop

Acceleration_time Ch#(0-1): Acceleration time configuration

0~65535ms

Deceleration_time Ch#(0-1): Deceleration time configuration

0~65535ms

Running_speed Ch#(0-1):running speed

0~200kHz

Running_steps Ch#(0-1):running steps (signed32)

0-2³²

Jog_speed Ch#(0-1):jog speed

0~200kHz

6 Configuration parameter definition

Configuration parameter								
Bit No	Bit 7	Bit 6	Bit 5	Bit 4	Bit 3	Bit 2	Bit 1	Bit 0
Byte 0	Reserved							REF_16 Bit_Dat a_Form at
Byte 1	Filtering_Time							
Byte 2								
Byte 3	Reserved							

Data description:

REF_16Bit_Data_Format: 16 Bit data format. Default: A_B

0: A_B

1: B_A

Filtering_Time: DI Filtering time. Default: 10ms

0..65535ms

Configuration parameter CH0								
Bit No	Bit 7	Bit 6	Bit 5	Bit 4	Bit 3	Bit 2	Bit 1	Bit 0
Byte 0	Reserved							Pulse_O utput_M ode
Byte 1	Emergency_stop_time							
Byte 2								
Byte 3	Reserved					Zero_return_mode		
Byte 4	Return_to_zero_speed							
Byte 5								
Byte 6								
Byte 7								
Byte 8	Return_to_zero_approach_speed							
Byte 9								
Byte 10								
Byte 11								
Byte 12	Reserved		DI2_Mode		DI1_Mode		DI0_Mode	
Byte 13	Reserved					DI3_Mode		
Byte 14	Reserved			DO_mo de	Logical _selecti	Logical _selecti	Logical _selecti	Logical _selecti

			on(DI3)	on(DI2)	on(DI1)	on(DI0)
Byte 15	Unit_pulse_count					
Byte 16						
Byte 17	Reserved			Acceleration_and_deceleration_mode	Digital_output_fault_handling	Reverse_Enable
Byte 18	Reserved					
Byte 19	Reserved					
Byte 20	Reserved					
Byte 21	Reserved					

Configuration parameter CH1								
Bit No	Bit 7	Bit 6	Bit 5	Bit 4	Bit 3	Bit 2	Bit 1	Bit 0
Byte 0	Reserved							Pulse_Output_Mode
Byte 1	Emergency_stop_time							
Byte 2								
Byte 3	Reserved					Zero_return_mode		
Byte 4	Return_to_zero_speed							
Byte 5								
Byte 6								
Byte 7								
Byte 8	Return_to_zero_approach_speed							
Byte 9								
Byte 10								
Byte 11								
Byte 12	Reserved	DI6_Mode		DI5_Mode		DI4_Mode		
Byte 13	Reserved				DI7_Mode			
Byte 14	Reserved			D1_mode	Logical_selection(DI7)	Logical_selection(DI6)	Logical_selection(DI5)	Logical_selection(DI4)
Byte 15	Unit_pulse_count							
Byte 16								
Byte 17	Reserved			Acceleration_and_deceleration_mode	Digital_output_fault_handling	Reverse_Enable		

Byte 18	Reserved
Byte 19	Reserved
Byte 20	Reserved
Byte 21	Reserved

Data description:

Pulse_Output_Mode Ch#(0-1): Pulse output mode. Default: 0

- 0: Pulse + direction
- 1: Dual pluses CW/CCW

Emergency_stop_time Ch#(0-1): Emergency stop time. Default: 200

20~5000ms

Zero_return_mode Ch#(0-1): Zero return mode. Default: 2

- 0: Mode 1 (Forward origin return to zero)
- 1: Mode 2 (Negative origin back to zero)
- 2: Mode 3 (Positive limit back to zero)
- 3: Mode 4 (Negative limit back to zero)

Return_to_zero_speed Ch#(0-1): Return to zero speed. Default: 1000

1~200Khz

Return_to_zero_approach_speed Ch#(0-1): Return to zero approach velocity. Default:

500

1~200Khz

DI0_Mode Ch#0: DI Function selection. Default: 0

- 0: Non-function
- 1: Positive limit
- 2: Driver ready signal
- 3: Scram signal

DI1_Mode Ch#0: DI Function selection. Default: 0

- 0: Non-function
- 1: Positive limit
- 2: Driver ready signal

3: Scram signal

DI2_Mode Ch#0: DI Function selection. Default: 0

0: Non-function

1: Positive limit

2: Driver ready signal

3: Scram signal

DI3_Mode Ch#0: DI Function selection. Default: 0

0: Non-function

1: Positive limit

2: Negative limit

3: Origin signal

4: Driver ready signal

5: scam signal

DI4_Mode Ch#1: DI Function selection. Default: 0

0: Non-function

1: Positive limit

2: Driver ready signal

3: Scram signal

DI5_Mode Ch#1: DI Function selection. Default: 0

0: Non-function

1: Positive limit

2: Driver ready signal

3: Scram signal

DI6_Mode Ch#1: DI Function selection. Default: 0

0: Non-function

1: Positive limit

2: Driver ready signal

3: Scram signal

DI7_Mode Ch#1: DI Function selection. Default: 0

- 0: Non-function
- 1: Positive limit
- 2: Negative limit
- 3: Origin signal
- 4: Driver ready signal
- 5: scram signal

Logical_selection (DIn) Ch#(0-1): DI logical choice. Default: 0

- 0: normal open
- 1: normal close

Unit_pulse_count Ch#(0-1): Unit pulse count. Default: 1

1~60000

Reverse_Enable Ch#(0-1):reverse enable. Default: 0

- 0: disabled
- 1: enabled

Digital_output_fault_handling Ch#(0-1): Digital output troubleshooting. Default: 1

- 0: hold the output value
- 1: zeroing the output value

Acceleration_and_deceleration_mode Ch#(0-1): Acceleration and deceleration mode

Default: 1

- 0: Trapezoidal acceleration and deceleration
- 1: S-shaped acceleration and deceleration

A Dimension drawing

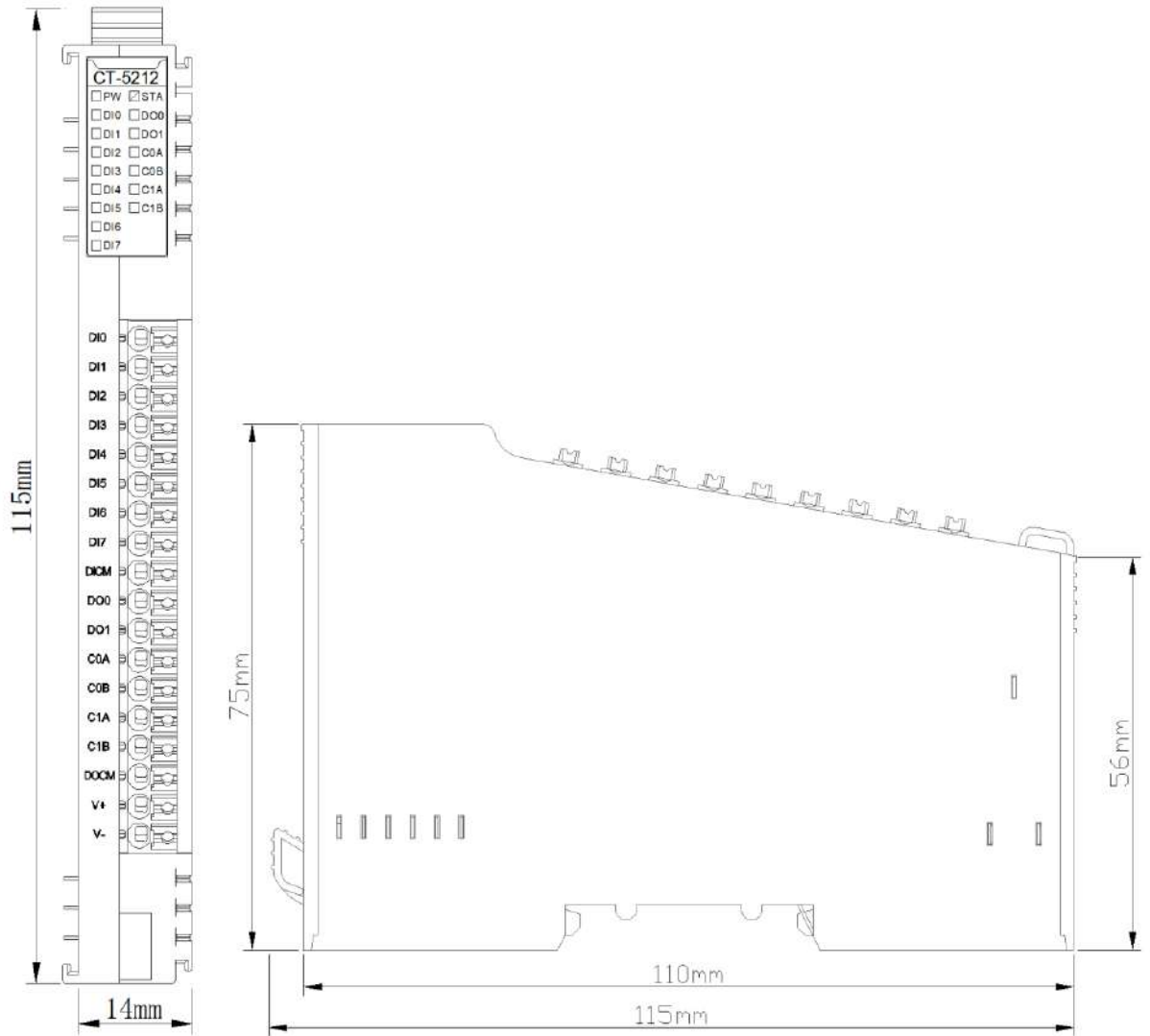

CT-5224 4-channel digital input/4-channel digital output/4-channel PWM output

1 Module features

- ◆ The module supports 4-channel digital input and sink input. The input high level (sink) is valid, it could support PNP sensor;
- ◆ The module supports 4-channel digital source output, the output high level is valid;
- ◆ The module supports 4-channel PWM output, it could output 40 frequencies, and the duty cycle is adjustable.
- ◆ The module supports inter-channel duty cycle synchronization, PWM0 is synchronized with PWM1, PWM2 is synchronized with PWM3.

2 Technical parameters

General Parameters	
Power	System: Max.120mA@5.0VDC
Isolation	The isolation voltage between field power and system power supply: AC 500V The isolation voltage between I/O channel and system power supply: AC 500V The isolation voltage between I/O channel and PE: AC 500V The isolation voltage between digital input and output channels: AC 500V
Filed Power	Supply: 20.4-28.8V (nominal: 24VDC) Protection: reverse protection
Wiring	Max.: AWG 18 Min.: AWG 24
Mounting Type	35mm DIN-Rail
Size	115*14*75mm
Weight	75g
Environment Specification	
Operating Temperature	-35°C~70°C
Ambient Humidity	5%-95% (No Condensation)
Ingress Protection Rating	IP20
DI Parameters	
Channel Number	4-channel input
Indicator	4-channel input indicator
Input Type	IEC61131-2 Type3
Turn-on Voltage	Sink: 11~30Vdc (compared with COM terminal)
Turn-off Voltage	Sink: -3~5Vdc (compared with COM terminal)
Turn-on Current	2.1mA@DC 11V (IEC61131, type3)
Input Impedance	>5KΩ@DC 24V
Input Delay	OFF to ON: <1ms ON to OFF: <1ms
Filter Time	Default: 10ms
Sample Frequency	500Hz
DO Parameters	
Channel Number	4-channel output
Indicator	4-channel output indicator
Rated Current	Max. 0.5A@DC 24V
Leakage Current	<5μA
Output Impedance	Typical value: <230mΩ
Output Delay	OFF to ON: <5μs ON to OFF: <10μs
Output Type	Source / High-side output
Protection Function	Short circuit protection support Overcurrent protection: 3A Over-temperature protection: thermal protection temperature of the channel: 167°C

	Chip thermal protection temperature: 150°C
PWM Parameters	
Channel Number	4-channel output
Rated Current	Max. 0.5A@DC 24V
Leakage Current	<5μA
On-resistance	Typical value: 230mΩ
Output Delay	OFF to ON: <1μs ON to OFF: <1μs
Pulse Duration Accuracy	±0.5μs
Pulse Duration Resolution	50ns
Minimum Pulse Duration	1us
Maximum Switching Frequency	60KHz
Pulse Rise Time	<200ns
Pulse Decay Time	<100ns
Protection Function	Short circuit protection support Overcurrent protection: 3A Over-temperature protection: thermal protection temperature of the channel: 167°C Chip thermal protection temperature: 150°C
EMC Parameters	
Static Electricity	Contact: 6KV Air: 8KV
EFT	Power: 2KV Signal: 1KV
Surge	Common mode: 2KV Differential mode: 1KV

WARNING

UNEXPECTED EQUIPMENT OPERATION

Do not exceed any of the ratings specified in the environmental and electrical characteristics table.

Failure to follow instructions specified by the manufacturer may result in serious consequences such as death, personal injury, or damage to equipment since the protection provided by the equipment may be impaired.

AVERTISSEMENT

FONCTIONNEMENT INATTENDU DE L'EQUIPEMENT

Ne dépassez aucune évaluation spécifiée dans le tableau de caractéristiques environnementales et électriques..

Le fait de ne pas suivre les instructions peut entraîner une défaillance de la protection fournie par l'équipement, ce qui peut entraîner des conséquences graves, comme des blessures ou des dommages à l'équipement.

3 Hardware interfaces

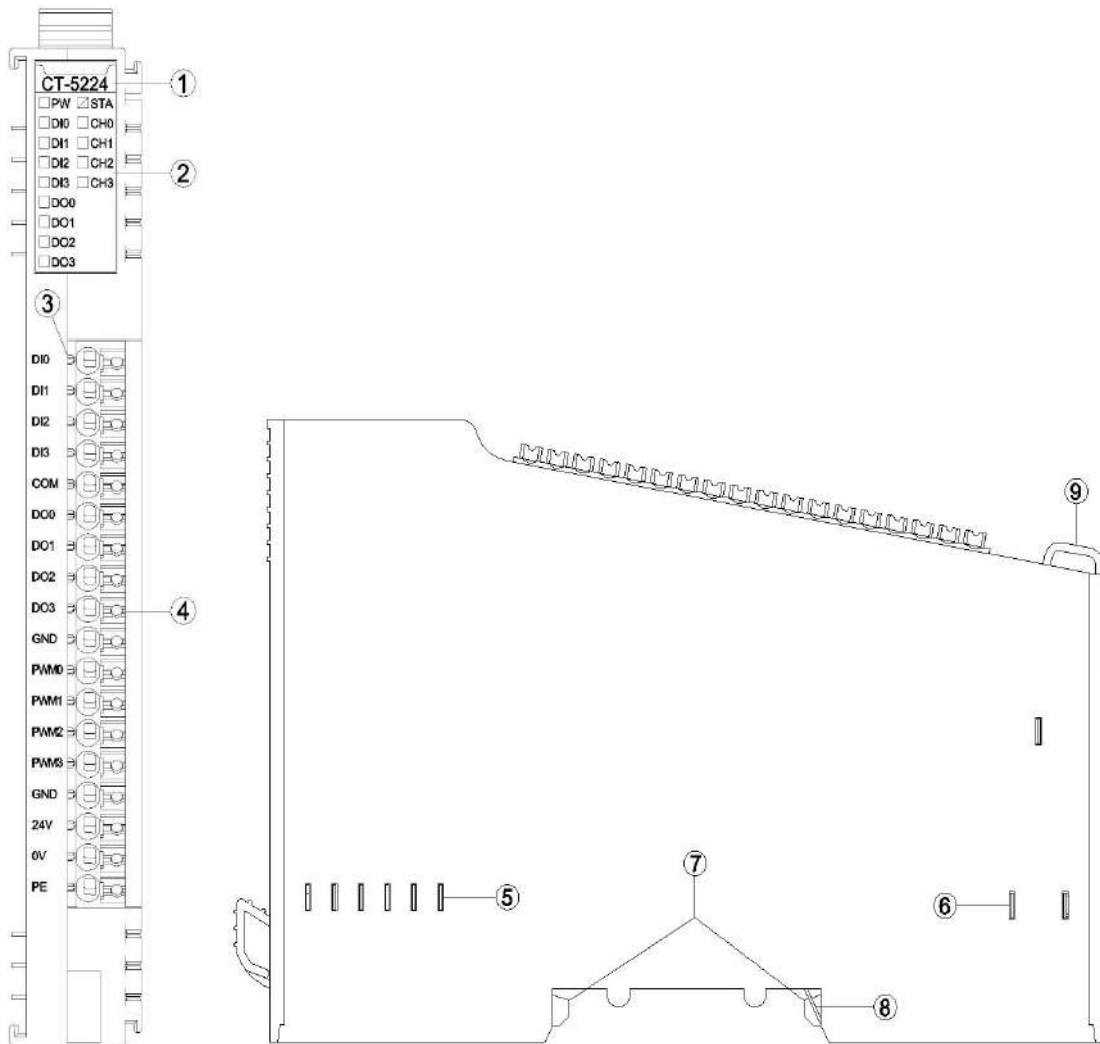

- ① Module Type
- ② State indicator
- ③ Channel indicator
- ④ Wiring Terminal and identification
- ⑤ Internal Bus
- ⑥ Field Power
- ⑦ Buckle
- ⑧ Grounding Spring Sheet
- ⑨ Fixed Wiring Harness

3.1 LED Indicator definition

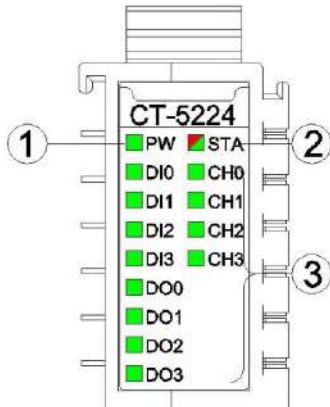

- ① Power indicator (green)
- ② Module state indicator (red/green)
- ③ Input/output channel indicators (green)

PW Power State (green)	Definition
ON	System power supply normal
OFF	System power supply failure
STA Module State (red/green)	Definition
Red flashes twice	Module exception has been soft-restarted
Green normally on	Module works normally
Green single flash	Stop mode
Flash(2.5Hz) (red/green)	Upgrading mode
Flash(10Hz) (red/green)	Firmware Upgrading
DI0~DI3 Input channel indicators (green)	Definition
ON	Digital input signal valid
OFF	Digital input signal invalid
D00~D03 Output channel indicators (green)	Definition
ON	Digital output signal valid
OFF	Digital output signal invalid
CH0~CH3 Output channel indicators (green)	Definition
ON	PWM Output signal valid
OFF	PWM Output signal invalid

WARNING

UNEXPECTED EQUIPMENT OPERATION

By viewing the PW indicator, could determine the power supply status of a module. If the PW is

steady green, the power supply is normal. Otherwise, the module cannot work properly.

When the module is initially powered on, there will be 3S for the backplane bus connection. After the backplane bus is initialized, STA is in the green steady state. If STA is in the green blinking state, it indicates that the backplane bus has not been initialized, and it needs to be powered off and restarted for re-initialization.

STA abnormal working state occurs during the normal operation of the module, please check the firmware version information of all modules, and consult ODOT technical support for details.

If a module is upgraded, check that all modules are in the normal state after the upgrade. Otherwise, an exception may occur.

Failure to follow instructions specified by the manufacturer may result in serious consequences such as death, personal injury, or damage to equipment since the protection provided by the equipment may be impaired.

⚠️ AVERTISSEMENT

FONCTIONNEMENT INATTENDU DE L'EQUIPEMENT

En regardant l'état de l'indicateur de PW, jugez l'état d'alimentation du module. Le feu vert PW reste allumé et l'alimentation est normale. Autrement, le module ne fonctionnera pas correctement.

Lorsque le module est alimenté initialement, il y aura 3S pour la connexion de bus de backboard. STA est un état vert permanent après l'initialisation du bus de backboard. Si STA est en état de clignotement vert, cela signifie que l'initialisation du bus de backboard n'est pas passée et doit être redémarrée hors tension et réinitialisée.

L'état de fonctionnement anormal de STA se produit pendant le fonctionnement normal du module, veuillez vérifier les informations de version du firmware de tous les modules, et consulter le support technique ODOT pour plus de détails.

Si le module a une opération de mise à niveau, après l'achèvement de la mise à niveau, le besoin de vérifier que tous les modules sont dans l'état normal avant de courir, sinon il conduira à une exception.

Le fait de ne pas suivre les instructions peut entraîner une défaillance de la protection fournie par l'équipement, ce qui peut entraîner des conséquences graves, comme des blessures ou des dommages à l'équipement.

3.2 Field channel LED indicator (Green)

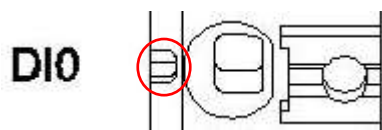

When the input signal of the input channel is valid, the corresponding field channel indicator is on.



When the output signal of the output channel is valid, the corresponding field channel indicator is on.

3.3 Terminal definition

Terminal Number	Symbol	Instruction
1	DI1	Digital signal input
2	DI2	
3	DI3	
4	DI4	
5	COM	Input common terminal
6	DO1	Digital signal output
7	DO2	
8	DO3	
9	DO4	
10	GND	Signal ground
11	PWM1	PWM output
12	PWM2	
13	PWM3	
14	PWM4	
15	GND	Signal ground
16	24V	Field power
17	0V	
18	PE	Ground terminal

WARNING

UNEXPECTED EQUIPMENT OPERATION

Calculate the maximum field power current consumption of a single module based on the actual field load. If the total field power current consumption of all I/O modules exceeds the power supply capacity of the field power supply, you must add an extra power expansion module. Otherwise, an output channel exception may occur.

Failure to follow instructions specified by the manufacturer may result in serious consequences such as death, personal injury, or damage to equipment since the protection provided by the equipment may be impaired.

AVERTISSEMENT

FONCTIONNEMENT INATTENDU DE L'EQUIPEMENT

Calculez la consommation maximale de courant de champ d'un seul module en fonction de la charge de champ réelle. Si la consommation totale de courant de champ de tous les modules d'E/S dépasse

la capacité d'alimentation de l'alimentation de champ, vous devez ajouter un module d'extension de puissance supplémentaire. Dans le cas contraire, une exception de canal de sortie peut se produire.

Le fait de ne pas suivre les instructions peut entraîner une défaillance de la protection fournie par l'équipement, ce qui peut entraîner des conséquences graves, comme des blessures ou des dommages à l'équipement.

When connecting a cold-pressed terminal, the terminal must be terminated and checked in strict accordance with the corresponding termination specifications or requirements, and connect the cold-pressed terminal according to the corresponding node serial number. The conductor should use copper conductor and the conductor core should be larger than 0.2mm^2 and smaller than 1mm^2 (AWG18~AWG24). Cold-pressed terminal parameters are as follows:



! WARNING

UNEXPECTED EQUIPMENT OPERATION

Strip the length of the conductor insulation layer is greater than 10mm to ensure reliable signal connection.

The wire needs to use copper wire and the wire core is greater than or equal to 0.2mm^2 and less than or equal to 1mm^2 to ensure reliable signal connection.

When connecting a cold-press terminal, connect the cold-press terminal strictly in accordance with the corresponding termination specifications or requirements, and connect the cold-press terminal according to the corresponding node serial number.

Do not power on cold-press terminals until they are properly connected or fully locked.

Failure to follow instructions specified by the manufacturer may result in serious consequences such as death, personal injury, or damage to equipment since the protection provided by the equipment may be impaired.

! AVERTISSEMENT

FONCTIONNEMENT INATTENDU DE L'EQUIPEMENT

Dépouillez la longueur de la couche isolante du fil plus de 10mm pour assurer la connexion fiable du signal.

Le conducteur doit utiliser le fil de cuivre et le noyau de fil est supérieur ou égal à 0,2 mm², inférieur ou égal à 1mm², afin d'assurer la connexion fiable du signal.

Lorsque les terminaux de presse à froid sont terminés, ils doivent être terminés et visualisés en stricte conformité avec les spécifications ou les exigences correspondantes et terminés selon le numéro de série de noeud correspondant.

Il est interdit d'activer les bornes à froid avant qu'elles ne soient correctement articulées ou complètement verrouillées.

Le fait de ne pas suivre les instructions peut entraîner une défaillance de la protection fournie par l'équipement, ce qui peut entraîner des conséquences graves, comme des blessures ou des dommages à l'équipement.

DANGER

FIRE DANGER

Use the correct wiring rules only for the maximum current capacity of the I/O channel and power supply.

Failure to follow instructions specified by the manufacturer may result in serious consequences such as death, personal injury, or damage to equipment since the protection provided by the equipment may be impaired.

WARNING

UNEXPECTED EQUIPMENT OPERATION

Do not exceed any of the ratings specified in the environmental and electrical characteristics table.

Failure to follow instructions specified by the manufacturer may result in serious consequences such as death, personal injury, or damage to equipment since the protection provided by the equipment may be impaired.

AVERTISSEMENT

FONCTIONNEMENT INATTENDU DE L'EQUIPEMENT

Ne dépassez aucune évaluation spécifiée dans le tableau de caractéristiques environnementales et électriques..

Le fait de ne pas suivre les instructions peut entraîner une défaillance de la protection fournie par l'équipement, ce qui peut entraîner des conséquences graves, comme des blessures ou des dommages à l'équipement.

4 Wiring

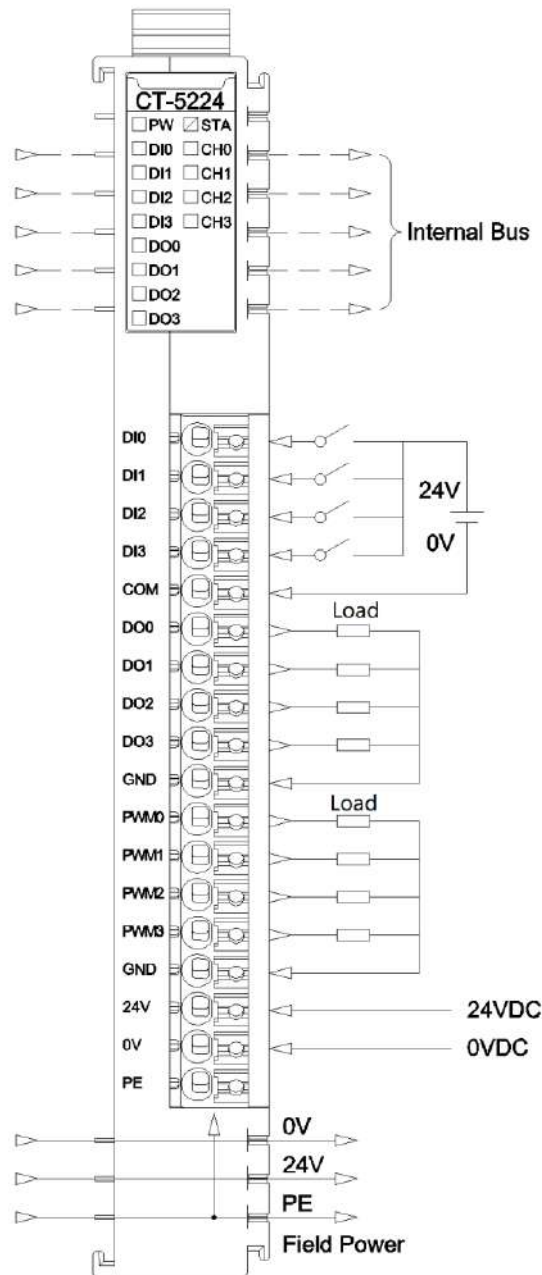

NOTICE

EQUIPMENT INOPERABLE

Do not crimp the spring terminal with more than the maximum pressure specified for the terminal. Otherwise, the resilience of the spring terminal may be damaged and the terminal rebound may be affected.

Do not press the spring terminal with a sharp tool when removing cable from the channel. Otherwise, the spring terminal will be damaged.

Failure to follow these instructions may result in equipment damage.

5 Process data definition

5.1 Input data

Input data								
Bit No	Bit 7	Bit 6	Bit 5	Bit 4	Bit 3	Bit 2	Bit 1	Bit 0
Byte 0	Reserved				DI Ch#3	DI Ch#2	DI Ch#1	DI Ch#0
Byte 1	DO Short Circuit (Ch#3)	DO Short Circuit (Ch#2)	DO Short Circuit (Ch#1)	DO Short Circuit (Ch#0)	PWM Short Circuit (Ch#3)	PWM Short Circuit (Ch#2)	PWM Short Circuit (Ch#1)	PWM Short Circuit (Ch#0)
Byte 2	Ch#1 QLMN HLM	Ch#0 QLMN HLM	PWM Output State (Ch#1)	PWM Output State (Ch#0)	STS SW Enable (Ch#1)	STS SW Enable (Ch#0)	ERR OUT VAL	ERR 24V
Byte 3	Reserved							Jitter Cycle Error
Byte 4	Ch#3 QLMN HLM	Ch#2 QLMN HLM	PWM Output State (Ch#3)	PWM Output State (Ch#2)	STS SW Enable (Ch#3)	STS SW Enable (Ch#2)	ERR OUT VAL	ERR 24V
Byte 5	Reserved							Jitter Cycle Error

Data description:

DI Input Data (Ch#0~ Ch#3): DI input status detection. When the input signal of the corresponding channel is valid, this bit is forced to 1, and when the input is invalid, this bit is forced to 0.

PWM Short Circuit (Ch#0~ Ch#3): Detect if there is a short circuit in the PWM channel. If there is a short circuit, this bit is forced to 1, and otherwise this bit is forced to 0;

DO Short Circuit (Ch#0~ Ch#3): Detect whether there is a short circuit in the DO channel. If there is a short circuit, this bit is forced to 1, and otherwise this bit is forced to 0;

ERR 24V: Detect whether the power supply in the field is undervoltage. If there is undervoltage, this bit is forced to 1, and otherwise this bit is forced to 0;

ERR OUT VAL: Detect if the frequency is misconfigured. If it is wrong, this bit is

forced to 1, and otherwise this bit is forced to 0;

STS SW ENABLE (Ch#0~ Ch#3): In the software-triggered mode, check whether the software enabled PWM output is valid. If it is valid, this bit is forced to 1, and otherwise this bit is forced to 0;

PWM Output State (Ch#0~ Ch#3): Detect the PWM output is valid, if it is valid, this bit is forced to 1, and otherwise this bit is forced to 0;

QLMN HLM (Ch#0~ Ch#3): Detect whether the PWM duty cycle is within the output range, if not, this bit is forced to 1, and otherwise this bit is forced to 0;

Jitter Sycle Error: Jitter cycle error. Detect whether the cycle time of jitter is greater than or equal to four times of the PWM output cycle time, if it is less than that, this bit is forced to 1, and otherwise this bit is forced to 0;

5.2 Output data

Output data								
Bit No	Bit 7	Bit 6	Bit 5	Bit 4	Bit 3	Bit 2	Bit 1	Bit 0
Byte 0	Reserved				DO Ch#3	DO Ch#2	DO Ch#1	DO Ch#0
Byte 1	Duty Cycle Value (Ch#0)							
Byte 2								
Byte 3								
Byte 4								
Byte 5	Reserved	Sync Switch	Jitter Switch (Ch#1)	Jitter Switch (Ch#0)	SW Active (Ch#1)	SW Active (Ch#0)	SW Trigger (Ch#1)	SW Trigger (Ch#0)
Byte 6	Reserved							
Byte 7	Duty Cycle Value (Ch#2)							
Byte 8								
Byte 9								
Byte 10	Duty Cycle Value (Ch#3)							
Byte 11	Reserved	Sync Switch	Jitter Switch (Ch#3)	Jitter Switch (Ch#2)	SW Active (Ch#3)	SW Active (Ch#2)	SW Trigger (Ch#3)	SW Trigger (Ch#2)
Byte 12	Reserved							

Data description:

Digital Output Data (Ch#0~ Ch#3): When this bit is 1, the corresponding channel output signal is valid, the output is high level, and the output is invalid when it is 0.

0: Output signal is invalid

1: Output signal is valid

Duty Cycle Value (Ch#0~ Ch#3): Output PWM duty cycle value. The output voltage is adjustable.

Output Range:0-10000, corresponds to the full scale 24V terminal access voltage.

SW Trigger (Ch#0~ Ch#3): Software-triggered switch. Operates only in software trigger mode (configured in configuration parameters).

0: Disable

1: Enable

SW Active (Ch#0~ Ch#3) : PWM active switch, it is used to control whether the PWM output is turned on or off. To enable output, set 1 in either hardware or software trigger mode.

0: OFF

1: ON

Jitter Switch (Ch#0~ Ch#3): Jitter switch, it is used to control whether the PWM jitter output is turned on or off.

0: OFF

1: ON

Sync Switch: Synchro switch, it is used to control the synchronous output of the PWM channel to be turned on or off.

Annotation: For channels at the same set of frequencies, that is (CH0 and CH1) (CH2 and CH3) synchronization and jitter functions could not be used at the same time.

6 Configuration parameter definitions

Configuration parameters								
Bit No	Bit 7	Bit 6	Bit 5	Bit 4	Bit 3	Bit 2	Bit 1	Bit 0
Byte 0	Reserved							16Bit Data Format
Byte 1	Input Filtering Time							
Byte 2								
Byte 3	Reserved				Input Holding Time			
Byte 4	Reserved				Fault Action (Ch#3)	Fault Action (Ch#2)	Fault Action (Ch#1)	Fault Action (Ch#0)
Byte 5	Reserved				Fault Value (Ch#3)	Fault Value (Ch#2)	Fault Value (Ch#1)	Fault Value (Ch#0)
Byte 6	Reserved				Module Offline Fault Action Output (Ch#3)	Module Offline Fault Action Output (Ch#2)	Module Offline Fault Action Output (Ch#1)	Module Offline Fault Action Output (Ch#0)
PWM Configuration parameters (Ch#0-Ch#1)								
Byte 0	Freq. Choice						Pulse Trigger Mode (Ch#1)	Pulse Trigger Mode (Ch#0)
Byte 1	Open DelayTime							
Byte 2								
Byte 3	Sync. AddMinus Time							
Byte 4								
Byte 5	Reserved					Channel Sync.		
Byte 6	Jitter Period							
Byte 7	Jitter Magnitude							
Byte 8	Jitter Slope							
Byte 9								
Byte 10	Reserved							
PWM Configuration parameters (Ch#2-Ch#3)								
Byte 0	Freq. Choice						Pulse Trigger Mode (Ch#3)	Pulse Trigger Mode (Ch#2)
Byte 1	Open DelayTime							
Byte 2								
Byte 3	Sync. AddMinus Time							
Byte 4								
Byte 5	Reserved					Channel Sync.		
Byte 6	Jitter Period							
Byte 7	Jitter Magnitude							
Byte 8	Jitter Slope							
Byte 9								
Byte 10	Reserved							

Module configuration parameter data description:

16Bit Data Format: Sequence of 16-bit data byte transmission (Default:0)

0: A_B

1: B_A

Input Filtering Time: Digital input filtering time. (Default:10)

Input range: 0-65535ms

Input Holding Time: Digital input hold time (ms). (Default:0)

0: Disable

1: 200ms

2: 500ms

3: 1000ms

4: 1500ms

5: 2000ms

6: 3000ms

7: 5000ms

Fault Action (Ch#0~ Ch#3): DO Fault output mode. When the I/O module detects that the internal bus enters offline mode abnormally, it processes the output data in this way. (Default :1)

0: Keep the last output value

1: Outputs the fault value

Fault Value (Ch#0~ Ch#3): Fault output value. When the fault output mode is 1, this bit sets the fault output value. When the internal bus of the I/O module is offline, this bit is output. (Default :0)

0: Output low level

1: Output high level

Module Offline Fault Action Output (Ch#0~ Ch#3): PWM module offline fault action output. (Default:1)

0: Keep the last output value

1: Reset

PWM Configuration parameter (Ch#0~Ch#3) data description:

Pulse Trigger Mode (Ch#0~Ch#3): Trigger mode. When the software is selected to trigger, the module could be output directly through the host computer. When the hardware trigger is selected, the external voltage must be input to the DI port to ensure that the DI port detects the voltage. Each channel could be configured independently. (Default :0)

0: Software trigger

1: Hardware trigger

Freq. Choice: Frequency choice. Ch#0 and Ch#1 use the same frequency, Ch#2 and Ch#3 use the same frequency. (Default:26)

0: 1HZ

1: 2HZ

2: 3HZ

3: 4HZ

4: 5HZ

- 5: 6HZ
- 6: 8HZ
- 7: 10HZ
- 8: 15HZ
- 9: 20HZ
- 10: 25HZ
- 11: 30HZ
- 12: 40HZ
- 13: 50HZ
- 14: 60HZ
- 15: 80HZ
- 16: 100HZ
- 17: 150HZ
- 18: 200HZ
- 19: 250HZ
- 20: 300HZ
- 21: 400HZ
- 22: 500HZ
- 23: 600HZ
- 24: 750HZ
- 25: 800HZ
- 26: 1KHZ
- 27: 1.2KHZ
- 28: 1.5KHZ
- 29: 2.0KHZ
- 30: 3.0KHZ
- 31: 4.0KHZ
- 32: 6.0KHZ
- 33: 12KHZ
- 34: 15KHZ
- 35: 20KHZ
- 36: 24KHZ
- 37: 30KHZ
- 38: 40KHZ
- 39: 60KHZ

Open DelayTime: Open delaytime. After the data is sent to the host computer, the output is delayed for a period of time. (Default :0)

Input range: 0-65535

Unit: ms

Sync. AddMinus Time: Synchronize acceleration and deceleration time. Synchronous acceleration and deceleration time and channel synchronization source are used to implement channel synchronization. (Default :20)

Input range: 20-5000

Unit: ms

Channel Sync. (Ch#0~Ch#1) : Channel synchronization source. That is, if channel A is selected, channel A is used for reference, and the duty cycle between channel B and channel A is synchronized. Synchronous acceleration and deceleration time and channel synchronization source are used to implement channel synchronization.

(Default :0)

0: Disabled

1: CH#0

2: CH#1

Channel Sync. (Ch#2~Ch#3) : Channel synchronization source. That is, if channel A is selected, channel A is used for reference, and the duty cycle between channel B and channel A is synchronized. Synchronous acceleration and deceleration time and channel synchronization source are used to implement channel synchronization.

(Default :0)

0: Disabled

1: CH#2

2: CH#3

Jitter Period: Jitter Period. The jitter period, jitter amplitude, and jitter slope are used to implement the jitter function of the channel duty cycle. (Default :2)

Input range: 2-100

Unit: ms

Jitter Magnitude: Jitter amplitude, which is used to adjust the jitter amplitude of the duty cycle. The jitter period, jitter amplitude, and jitter slope are used to implement the jitter function of the channel duty cycle. (Default :0)

Input range: 0-50

Unit: %

Jitter Slope: Jitter slope, used to control the duration of the jitter ramp up and ramp down of the duty cycle. The jitter period, jitter amplitude, and jitter slope are used to implement the jitter function of the channel duty cycle. (Default :0)

Input range: 0-30000

Unit: ms

A Dimension drawing

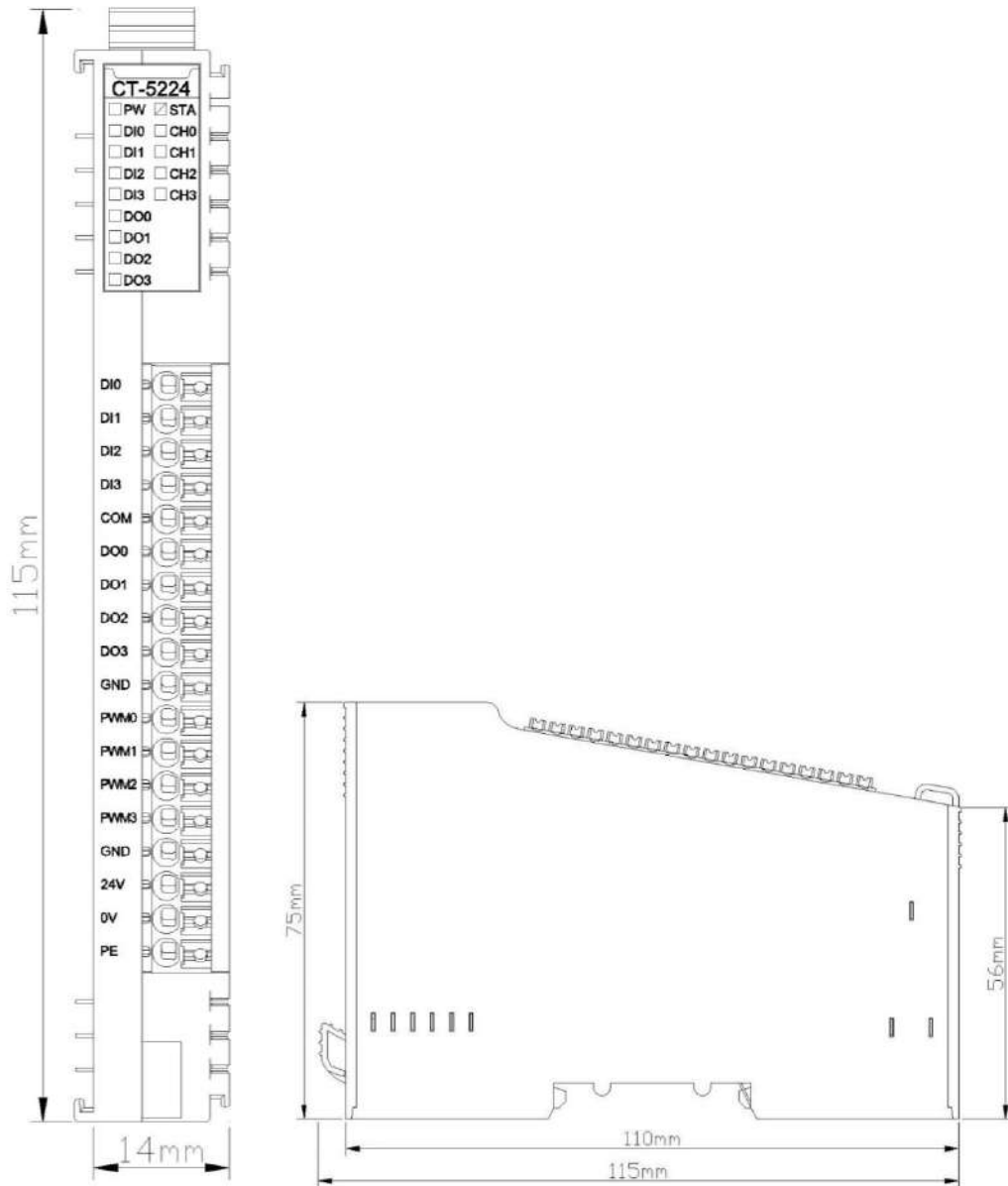

CT-5321 Modbus Serial Port Module

1 Module Description

The Modbus serial port module supports 1 channel RS485/RS232 /RS422 (optional), supports Modbus RTU/ASCII protocol, and supports master, slave and free transparent transmission mode.

The serial Module **CT-5321** could be applied with the I/O adapter modules, so it could convert Modbus into other protocols such as Modbus TCP, Profinet, EtherCAT, EtherNet/IP, etc. When the module is used, serial port parameters and Modbus instructions should be configured in IO Config software.



Devices with RS485/RS232/RS422 interface, which support Modbus-RTU /ASCII, could be applied with **CT-5321** to realize interconnection with upper PLC or upper computers. **CT-5321** could be applied with devices such as: PLC, DCS, remote IO, VFD, motor start protection device, intelligent high and low voltage electrical apparatus, power measurement device, intelligent field measurement equipment and instruments, etc.

2 Technical Parameters

General Parameters	
Power	Max.50mA@5.0Vdc
Isolation	I/O to internal bus: opto-couple isolation (3KVrms)
Field Power	Supply: 20.4-28.8VDC(Nominal:24VDC)
Wiring	Max.: AWG 18
Mounting Type	35mm DIN-Rail
Size	115*14*75mm
Weight	65g
Vibration Resistance	Comply with IEC 61131-2 and EC 60068-2-6
Impact resistance	Comply with IEC 61131-2 and IEC 60068-2-27
EMC Performance	Comply with IEC 61131-2 and IEC 61000-4
Environment Specification	
Operating Temperature of Horizontal Installation	-35°C~70°C
Operating Temperature of Vertical Installation	-35°C~60°C
Relative Humidity	< 95%RH (No Condensation)
Storage Temperature	-40°C~85°C
Storage Humidity	< 95%RH (No Condensation)
Manufacturing Test Temperature	-40°C~75°C
Ingress Protection Rating	IP20
Serial Port Parameters	
M/S/F:Channel Number	1 Channel
M/S/F:Interface	RS485/RS232/RS422
M/S:Protocol	Modbus RTU/ASCII
M/S/F:Working Mode	Modbus Master, Slave, Transparent Transmission
M/S/F:Baud Rate	300bps-500Kbps
M/S/F:Data Bit	Bit 7, Bit 8
M/S/F:Parity Checking	N/A, Odd, Even
M/S/F:Stop Bit	Bit1, Bit2
M/S/F: Character Interval	1.5t-200t
F: Byte Order Conversion	Prohibit, Enable
M/F:Response Timeout	Customized, default: 1000
M/F: Polling Timeout	Customized, default: 100
M: Read Data Processing Mode	Hold the last input value, clear the input value

M: Data Output Mode	Polling, event triggering (data changes)
M: Module Control Enable	Prohibit, Enable
M: Module Control Mode	Level trigger (continuously valid), rising edge trigger (single valid)
M: Power on Event Output	Prohibit, Enable
S:Slave ID	Customized, default: 1
S:Response Time	Customized, default: 50

Note: M represents the valid parameters of master mode, S represents the valid parameters of slave mode, and F represents the valid parameters of free transparent transmission mode.

 WARNING
<p>UNEXPECTED EQUIPMENT OPERATION</p> <p>Do not exceed any of the ratings specified in the environmental and electrical characteristics table.</p> <p>Failure to follow instructions specified by the manufacturer may result in serious consequences such as death, personal injury, or damage to equipment since the protection provided by the equipment may be impaired.</p>
 AVERTISSEMENT
<p>FONCTIONNEMENT INATTENDU DE L'EQUIPEMENT</p> <p>Ne dépassez aucune évaluation spécifiée dans le tableau de caractéristiques environnementales et électriques..</p> <p>Le fait de ne pas suivre les instructions peut entraîner une défaillance de la protection fournie par l'équipement, ce qui peut entraîner des conséquences graves, comme des blessures ou des dommages à l'équipement.</p>

3 Hardware Interface

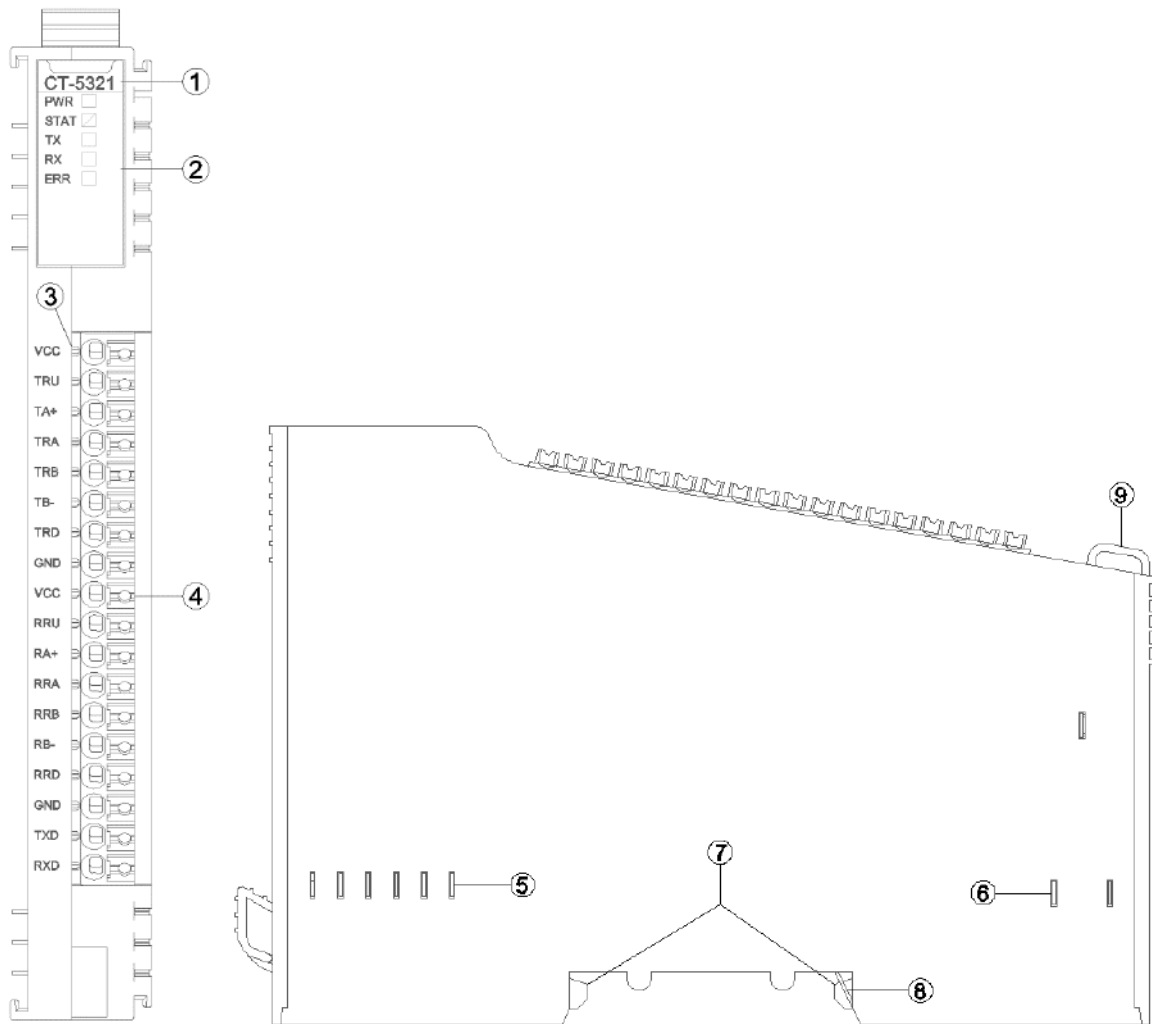

- ① Module Type
- ② State indicator
- ③ N/A
- ④ Wiring Terminal and identification
- ⑤ Internal Bus
- ⑥ Field Power
- ⑦ Buckle
- ⑧ Grounding Spring Sheet
- ⑨ Fixed Wiring Harness

3.1 Wiring Terminal

Terminal	RS485	RS422	RS232
VCC	4.7K Pull up resistance short connection	4.7K Pull up resistance short connection (TX)	
TRU			
TA+	A+	TX+	
TRA	120R Terminal resistance short connection	120R Terminal resistance short connection (TX)	
TRB			
TB-	B-	TX-	
TRD	4.7K Pull down resistance short connection	4.7K Pull down resistance short connection (TX)	
GND			
VCC	GND	4.7K Pull up resistance short connection (RX)	
RRU			
RA+		RX+	
RRA		120R Terminal resistance short connection (RX)	
RRB			
RB-		RX-	
RRD		4.7K Pull down resistance short connection (RX)	
GND			
TXD		TXD	
RXD		RXD	

WARNING

UNEXPECTED EQUIPMENT OPERATION

Calculate the maximum field power current consumption of a single module based on the actual field load. If the total field power current consumption of all I/O modules exceeds the power supply capacity of the field power supply, you must add an extra power expansion module. Otherwise, an output channel exception may occur.

Failure to follow instructions specified by the manufacturer may result in serious consequences such as death, personal injury, or damage to equipment since the protection provided by the equipment may be impaired.

AVERTISSEMENT

FONCTIONNEMENT INATTENDU DE L'EQUIPEMENT

Calculez la consommation maximale de courant de champ d'un seul module en fonction de la charge

de champ réelle. Si la consommation totale de courant de champ de tous les modules d'E/S dépasse la capacité d'alimentation de l'alimentation de champ, vous devez ajouter un module d'extension de puissance supplémentaire. Dans le cas contraire, une exception de canal de sortie peut se produire.

Le fait de ne pas suivre les instructions peut entraîner une défaillance de la protection fournie par l'équipement, ce qui peut entraîner des conséquences graves, comme des blessures ou des dommages à l'équipement.

When connecting a cold-pressed terminal, the terminal must be terminated and checked in strict accordance with the corresponding termination specifications or requirements, and connect the cold-pressed terminal according to the corresponding node serial number. The conductor should use copper conductor and the conductor core should be larger than 0.2mm^2 and smaller than 1mm^2 (AWG18~AWG24). Cold-pressed terminal parameters are as follows:

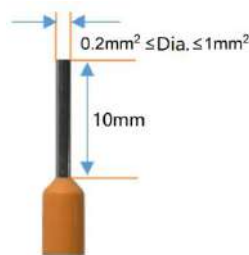

⚠ WARNING

UNEXPECTED EQUIPMENT OPERATION

Strip the length of the conductor insulation layer is greater than 10mm to ensure reliable signal connection.

The wire needs to use copper wire and the wire core is greater than or equal to 0.2mm^2 and less than or equal to 1mm^2 to ensure reliable signal connection.

When connecting a cold-press terminal, connect the cold-press terminal strictly in accordance with the corresponding termination specifications or requirements, and connect the cold-press terminal according to the corresponding node serial number.

Do not power on cold-press terminals until they are properly connected or fully locked.

Failure to follow instructions specified by the manufacturer may result in serious consequences such as death, personal injury, or damage to equipment since the protection provided by the equipment may be impaired.

⚠ AVERTISSEMENT

FONCTIONNEMENT INATTENDU DE L'EQUIPEMENT

Dépouillez la longueur de la couche isolante du fil plus de 10mm pour assurer la connexion fiable

du signal.

Le conducteur doit utiliser le fil de cuivre et le noyau de fil est supérieur ou égal à 0,2 mm², inférieur ou égal à 1mm², afin d'assurer la connexion fiable du signal.

Lorsque les terminaux de presse à froid sont terminés, ils doivent être terminés et visualisés en stricte conformité avec les spécifications ou les exigences correspondantes et terminés selon le numéro de série de noeud correspondant.

Il est interdit d'activer les bornes à froid avant qu'elles ne soient correctement articulées ou complètement verrouillées.

Le fait de ne pas suivre les instructions peut entraîner une défaillance de la protection fournie par l'équipement, ce qui peut entraîner des conséquences graves, comme des blessures ou des dommages à l'équipement.

DANGER

FIRE DANGER

Use the correct wiring rules only for the maximum current capacity of the I/O channel and power supply.

Failure to follow instructions specified by the manufacturer may result in serious consequences such as death, personal injury, or damage to equipment since the protection provided by the equipment may be impaired.

WARNING

UNEXPECTED EQUIPMENT OPERATION

Do not exceed any of the ratings specified in the environmental and electrical characteristics table.

Failure to follow instructions specified by the manufacturer may result in serious consequences such as death, personal injury, or damage to equipment since the protection provided by the equipment may be impaired.

AVERTISSEMENT

FONCTIONNEMENT INATTENDU DE L'EQUIPEMENT

Ne dépassez aucune évaluation spécifiée dans le tableau de caractéristiques environnementales et électriques..

Le fait de ne pas suivre les instructions peut entraîner une défaillance de la protection fournie par l'équipement, ce qui peut entraîner des conséquences graves, comme des blessures ou des dommages à l'équipement.

3.2 LED Indicator State

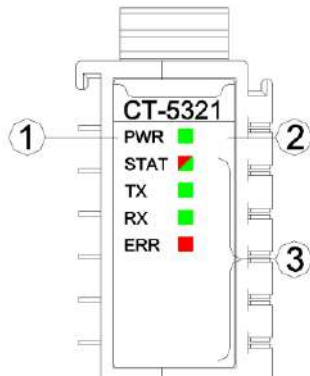

PW power indicator(Green)	Definition
ON	The system power supply is normal.
OFF	The system power supply is failure.
STAT Module State Indicator(Red/Green)	Definition
Double Flash (RED)	Module Exception has been soft-restarted
ON (GREEN)	Operational Mode
Green Single Flash	Stop mode
Flash(2.5Hz) (RED/GREEN)	Upgrading mode
Flash(10Hz) (RED/GREEN)	Firmware Update
TX Serial Port Sending Indicator	Definition
OFF	No data sending
Flash	Serial port data sending
RX Serial Port receiving Indicator	Definition
OFF	No data receiving
Flash	Serial port data receiving
ERR Running Indicator	Definition
OFF	Configuration normal, communication normal
Single Flash	Communication abnormal
Cycle Flash	Configuration error

WARNING

UNEXPECTED EQUIPMENT OPERATION

By viewing the PW indicator, could determine the power supply status of a module. If the PW is steady green, the power supply is normal. Otherwise, the module cannot work properly.

When the module is initially powered on, there will be 3S for the backplane bus connection. After the backplane bus is initialized, STA is in the green steady state. If STA is in the green blinking state, it indicates that the backplane bus has not been initialized, and it needs to be powered off and restarted for re-initialization.

STA abnormal working state occurs during the normal operation of the module, please check the firmware version information of all modules, and consult ODOT technical support for details.

If a module is upgraded, check that all modules are in the normal state after the upgrade. Otherwise, an exception may occur.

Failure to follow instructions specified by the manufacturer may result in serious consequences such as death, personal injury, or damage to equipment since the protection provided by the equipment may be impaired.

AVERTISSEMENT

FONCTIONNEMENT INATTENDU DE L'EQUIPEMENT

En regardant l'état de l'indicateur de PW, jugez l'état d'alimentation du module. Le feu vert PW reste allumé et l'alimentation est normale. Autrement, le module ne fonctionnera pas correctement.

Lorsque le module est alimenté initialement, il y aura 3S pour la connexion de bus de backboard. STA est un état vert permanent après l'initialisation du bus de backboard. Si STA est en état de clignotement vert, cela signifie que l'initialisation du bus de backboard n'est pas passée et doit être redémarrée hors tension et réinitialisée.

L'état de fonctionnement anormal de STA se produit pendant le fonctionnement normal du module, veuillez vérifier les informations de version du firmware de tous les modules, et consulter le support technique ODOT pour plus de détails.

Si le module a une opération de mise à niveau, après l'achèvement de la mise à niveau, le besoin de vérifier que tous les modules sont dans l'état normal avant de courir, sinon il conduira à une exception.

Le fait de ne pas suivre les instructions peut entraîner une défaillance de la protection fournie par l'équipement, ce qui peut entraîner des conséquences graves, comme des blessures ou des dommages à l'équipement.

4 Wiring

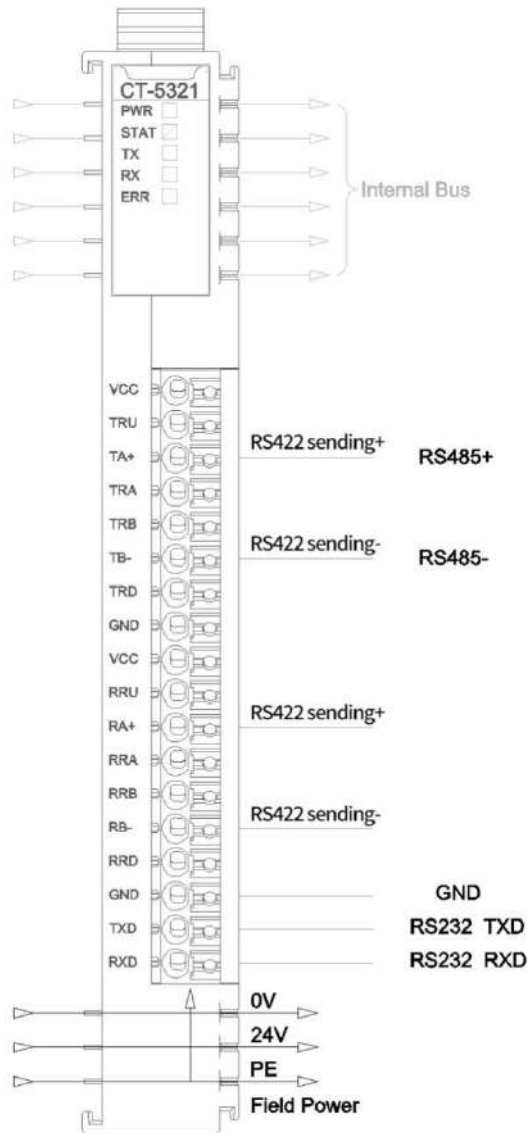

NOTICE

EQUIPMENT INOPERABLE

Do not crimp the spring terminal with more than the maximum pressure specified for the terminal. Otherwise, the resilience of the spring terminal may be damaged and the terminal rebound may be affected.

Do not press the spring terminal with a sharp tool when removing cable from the channel. Otherwise, the spring terminal will be damaged.

Failure to follow these instructions may result in equipment damage.

5 Process data definition

5.1 Module process data definition

CT-5321, the module itself has no input or output process data.

5.2 Submodule process data mapping

The network adapter reads and writes the input and output process data of the submodule of CT-5321 in real time through the internal bus. Its data mapping model is shown as the figure below:

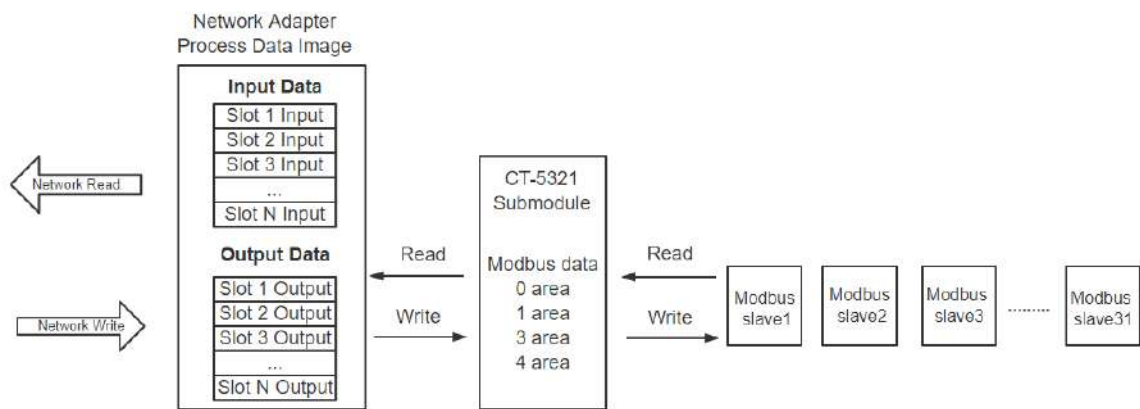

6 Configuration parameters definition

6.1 CT-5321 Configuration parameter definition

Configuration Parameter								
Bit No	Bit 7	Bit 6	Bit 5	Bit 4	Bit 3	Bit 2	Bit 1	Bit 0
Byte 0						BaudRate Select	Gateway Mode	
Byte 1	Standard BaudRate							
Byte 2								
Byte 3								
Byte 4								
Byte 5	Custom BaudRate							
Byte 6								
Byte 7								
Byte 8								
Byte 9		Byte Swap	Serial Mode	Stop Bits		Parity Bits		Data Bits
Byte 10	Char Pitch							
Byte 11	Response Timeout(ms)							
Byte 12								
Byte 13	Delay Between Polls(ms)							
Byte 14								
Byte 15				First Output on Power-Up	Module Control Mode	Module Control Enable	Output Mode	Fault Action for Read Command
Byte 16	Slave ID							
Byte 17	Response Delay(ms)							
Byte 18								

M/S/F: Gateway Mode: Module working mode (default: Modbus Master)

- 0: Modbus Master
- 1: Modbus Slave
- 2: Free port communication mode

M/S/F: Baudrate Selection (default: standard baud rate)

- 0: Standard baud rate
- 1: Customized baud rate

M/S/F: Standard BaudRate (default: 9600bps)

- 0: 300bps

- 1: 600bps
- 2: 1200bps
- 3: 2400bps
- 4: 4800bps
- 5: 9600bps
- 6: 14400bps
- 7: 19200bps
- 8: 38400bps
- 9: 57600bps
- 10: 115200bps
- 11: 128000bps
- 12: 230400bps
- 13: 256000bps
- 14: 384000bps
- 15: 500000bps

M/S/F: Custom BaudRate: 300-500000bps could be set, default: 9600 Note: The devices of a few customers are with non-standard Baud rate, and it could be customized.

M/S/F: Data Bits(default: Bit 8)

- 0: Bit 7
- 1: Bit 8

M/S/F: Parity Bits(default: N/A)

- 0: N/A
- 1: Odd
- 2: Even

M/S/F: Stop Bits(default: Bit 1)

- 0: Bit 1

1: Bit 2

M/S: Serial Mode (default: RTU)

0: RTU

1: ASCII

F:Btpe Swap (default: disabled)

0: Disabled

1: Enable

M/S/F: Char Pitch: Frame interval detection time when receiving a message (T is the transmission time of a single character and is related to the baud rate) . (default: 5 CH)

0: 1.5 CH

1: 3.5 CH

2: 5 CH

3: 10 CH

4: 20 CH

5: 50 CH

6: 100 CH

7: 200 CH

M/F: Response Timeout (ms): The time that the master sends a command and waits for a response from the slave. 1~65535 could be set, the default is 1000.

M/F: Delay Between Polls (ms): The interval time between Modbus commands (the delay between receiving the slave response message and sending the next command), 0~65535 could be set, default 100.

M: Fault Action for Read Command: The way the data is processed after the timeout of the slave read data. (Default: Hold last input value)

0: Hold the last input value

1: Clearing input value optional

M: Output Mode: The Modbus periodically sending write messages under "polling mode". In "event triggered" mode, write commands are sent only when the Modbus output data changes.(Default: polling)

0: polling

1: Event triggers (data changes)

M: Module Control Enable: When it is necessary to control the read and write commands of Modbus, it could select enabling mode and control the read and write commands of Modbus by controlling the value of "module control output". (Default: disabled)

0: disabled

1: enable

M: Module Control Mode.This value is valid only in module control enabled mode. (Default: Level triggered)

0: Level trigger (effective continuously)

1: Rising edge trigger (single trigger)

M: First Output on Power-on. (Default: enabled)

0: disabled

1: enable

S: Slave ID: 1-247 could be set. This parameter is only valid in slave mode.

S: Respond Delay (MS): 0~65535 is optional, default 50.

6.2 CT-5321 Parameter definitions for submodules

6.2.1 Submodules in master mode

M: Diagnostic module

M: Reading coil (0xxxx), it supports 8~128bits optionally

M: Reading discrete input (1xxxx), it supports 8~128bits optionally

M: Reading input register (3xxxx), it supports 1~16words optionally

M: Reading hold register (4xxxx), it supports 1~16words optionally

M: Writing coil (0 xxxx), it supports single coil and 8~128bits optionally

M: Writing hold register (4xxxx), it supports single register and 1~16words optionally

M: Diagnostic module, it includes module status input, module error code input, module control output, and polling time input. The drop-down menu commands need to be added to the first 8 lines of the slot.

1. Module state input: there are 8~48 channels available. The module state could monitor the working state of each data slot. When a data slot fails, the corresponding state bit will be set to 1, and it would be reset automatically after failure recovery.
2. Module error code input: there are 8~48 channels available. When the data slot fails, the error code module could display the function code of the error channel and the detailed error code. According to the error code, the user can judge the cause of the fault, and then take the corresponding adjustment method. See "Modbus Error Code Table" for a detailed description.
3. Module control output: there are 8~48 channels available. The read/write channel for output control of the command is valid when the parameter (M: module control) under the serial port is in enabled mode.
4. Polling time input: Polling time is used for monitoring serial ports.

6.2.2 Submodules in slave mode

S: Diagnostic module

S: Reading coil (0xxxx), it supports 1~1024Bytes optionally

S: Reading hold register (4xxxx), it supports 1~512words optionally

S: Writing coil (0xxxx), it supports 1~1024Bytes optionally

S: Writing discrete input (1xxxx), it supports 8~1024Bytes optionally

S: Writing input register (3xxxx), it supports 1~512words optionally

S: Writing hold register (4xxxx), it supports 1~512words optionally

S:Diagnostic module

The module could monitor the communication failure by entering the state in slave.

Please see the following table to check the failure.

Modbus Error code table

Error Code	Fault description	Troubleshooting method
0x00	Working properly	N/A
0x01	Illegal function code	The device does not support the current function code, please refer to the slave manual to select the corresponding function code module
0x02	Illegal data address	If the device data exceeds its address range, refer to the slave manual to modify the data starting address or data length
0x03	Illegal data value	Data length error, data length beyond the Max. allowed value 125(Word) or 2000(Bit), modify the length
0x04	Data processing error	Check that if the range of data values meets the slave requirements
0x05	Application layer length mismatch	Increase the receive character pitch and check the communication parameter Settings
0x06	Protocol ID error	Check the sending end message
0x07	Cache address error	Device internal error
0x08	Bit offset error	Device internal error
0x09	The slave ID number does not match	Increase timeout time, check hardware connection state, and check communication parameter Settings
0x0A	CRC Error	CRC error, check communication line
0x0B	LRC Error	LRC error, check communication line
0x0C	Answer function codes do not match	Check the hardware connection state
0x0D	Answer addresses do not match	Check the hardware connection state
0x0E	The length of the reply data does not match	Check the hardware connection state
0x0F	Communication timeout	Increase timeout time, check hardware connection state, and check communication parameter Settings
0x10	ASCII mode starting character Error	‘:’ Colon starting character Error
0x11	ASCII mode terminator character Error	CR/LF Carriage return terminator character Error
0x12	ASCII mode non-character data	The data contains non-hexadecimal ASCII codes
0x13	ASCII mode character error	Slave answering length error

6.2.3 Submodule in free transparent transmission mode

F: Control and state modules

F: Input and output data modules all support 1~512words optionally

Definition of process data for control and state modules

IO module data direction	Data Name	Variable Name	Data Type	Byte Offset
Input Data	Output control word – Feedback	Control_Word_Feedback	uint16_t	0
	Send frame byte length- feedback	Send_Data_Len_Feedback	uint16_t	2
	Serial State	COM_Status	uint16_t	4
	Received Error frame count	Error_Counter	uint16_t	6
	Total received data frame count	Received_Counter	uint16_t	8
	The current received frame byte length	Received_Data_Len	uint16_t	10
Output Data	Output control word	Control_Word	uint16_t	0
	Send frame byte length	Send_Data_Len	uint16_t	2

Variable Definition:

Variable Name	Bit 15-7	Bit 6	Bit 5	Bit 4	Bit 3	Bit 2	Bit 1	Bit 0
Control_Word_Feedback	Reseverd	Input Data Reset	Received Reset	Error Reset	Timeout Reset	Parity Reset	Done Reset	Trigger
Send_Data_Len_Fedddback	Send Data Len							
COM_Status	Reseverd				Timeout Error	Parity Error	Done	Busy
Error_Counter	Error Counter							
Received_Counter	Received Counter							
Received_Data_Len	Received Data Len							
Control_Word	Reseverd	Input Data Reset	Received Reset	Error Reset	Timeout Reset	Parity Reset	Done Reset	Trigger
Send_Data_Len	Send Data Len							

Input data description:

1. Control_Word_Feedback is the feedback value of Control_Word, which will be updated to the control word feedback after the output control word is refresh to the module

2. Send_Data_Len_Feedback is the feedback value of Send_Data_Len. After the length of sending frame bytes is refreshed to the module, it will be updated to the length feedback of sending frame bytes.

3. In the response mode, when the serial ports are sending data, the Busy bit is set to 1.

3.1 When the serial port receives the reply within the timeout period, the Busy bit will be reset, and Done will be completed at position 1 and Received_Counter will calculate the value plus 1. If there is a parity error in the received frame, and Parity_Error will be set to 1, while Error_Counter will count plus 1. Received_Data_Len holds the number of bytes of the currently received frame.

3.2 When the serial port does not receive a reply within the timeout period, the Busy bit will be reset, and the Done will be completed at position 1. At the same time, Timeout_Error will be set as 1, and the Error_Counter will be added as 1, so the Received_Data_Len value will be reset.

4. In the active report mode, when slave received the data packet, and the Received_Counter will count as a value plus 1. If there is a parity error in the received frame, the Parity_Error bit will be set to 1, while the Error_Counter will count plus 1.

Description of output data:

1. When Received_Counter_Reset is in rise edge, the Received_Counter value will be reset.

When Error_Counter_Reset is in rise edge, Error_Counter value will be reset.

When Timeout_Error_Reset s in rise edge, Timeout_Error will be reset.

When Parity_Error_Reset is in rise edge, Parity_Error will be reset.

When Done_Reset is in rise edge, Done will be reset.

2. In the active report mode, the Trigger bit is invalid and the Send_Data_Len is invalid.
3. In master-slave response mode, when Trigger is in rise edge, and it will Trigger serial port to send data for one time, and the serial port will send data packets according to the data length of Send_Data_Len and wait for the replying processing.

A Dimension drawing

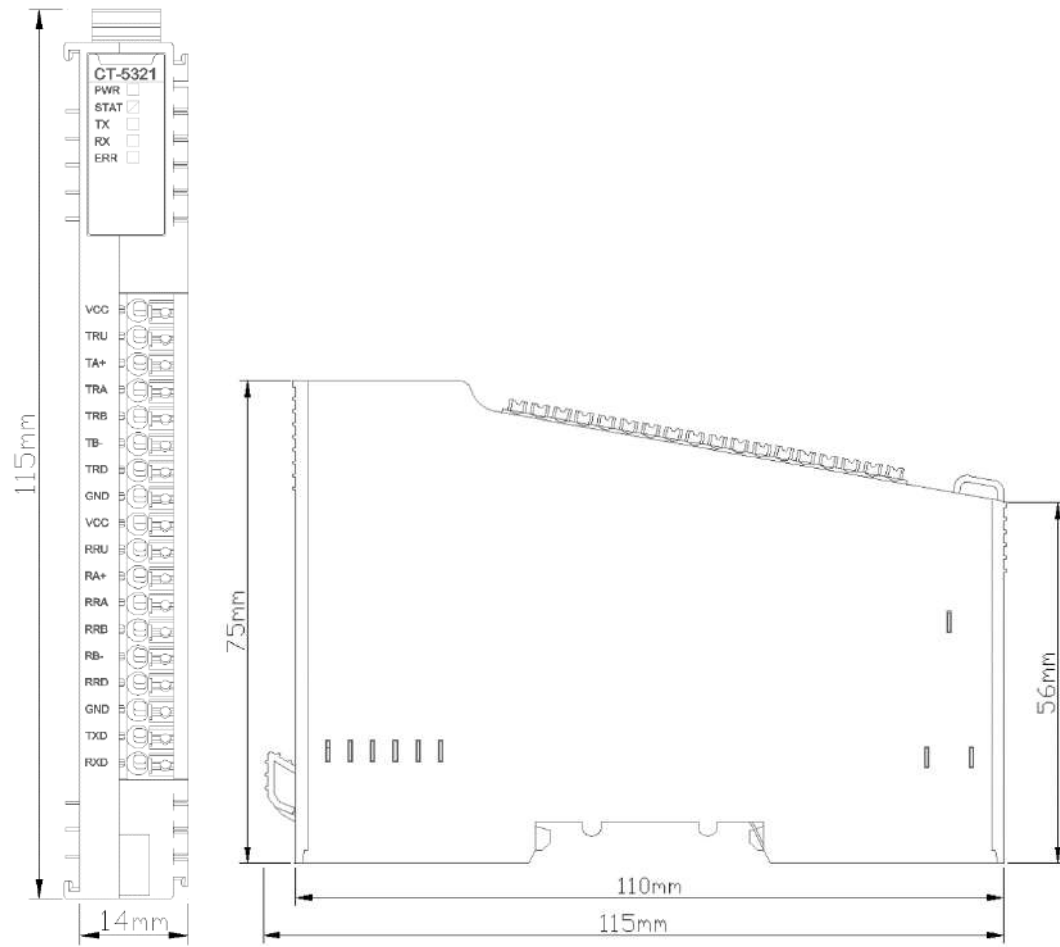

CT-5331 CANopen Master module

1 Module Description

The CANopen master module supports 1 x CAN interface, supports the CANopen master working mode.

The CT-5331 could be applied with the I/O adapter modules, so it could convert CANopen into other protocols, such as Modbus-TCP, Profinet, EtherCAT, Ethernet/IP, etc. When the module is used, input and output commands need to be configured in the IO Config software through the Type-C interface of the module.

All slave devices that support the CANopen protocol can use this module to interconnect with the upper PLC or the upper computer. Such as: CANopen remote IO station, CANopen various sensors, CANopen drivers and so on.

2 Technical Parameters

General Parameters	
Power	Max.50mA@5.0Vdc
Isolation	I/O to internal bus: opto-couple isolation (3KVrms)
Field Power	Nominal voltage: 24Vdc Input range: 20.4~28.8Vdc
Wiring	I/O wiring: Max.: AWG 18
Mounting Type	35mm Din-Rail
Size	115*14*75mm
Weight	65g
Vibration Resistance	Comply with IEC 61131-2 and EC 60068-2-6
Impact resistance	Comply with IEC 61131-2 and IEC 60068-2-27
EMC Performance	Comply with IEC 61131-2 and IEC 61000-4
Environment Specification	
Operating Temperature of Horizontal Installation	-35°C~70°C
Operating Temperature of Vertical Installation	-35°C~60°C
Relative Humidity	< 95%RH (No Condensation)
Storage Temperature	-40°C~85°C
Storage Humidity	< 95%RH (No Condensation)
Manufacturing Test Temperature	-40°C~75°C
Ingress Protection Rating	IP20
CAN Parameters	
Channel Number	1channel
Interface	CAN
Protocol	CANopen Conform DS301 V4.02
Working Mode	CANopen Master
Station Number	16 Slave station
Baud Rate	10K~1Mbps
Support	PDO, SDO, Heartbeat, NMT, EMCY and Network Scan
Support	Automatically assign PDO serial number, Default: disabled
Support	Automatically assign PDO COB-ID, Default: disabled
Support	Reset function to restore factory Setting

 **WARNING**

UNEXPECTED EQUIPMENT OPERATION

Do not exceed any of the ratings specified in the environmental and electrical characteristics table.

Failure to follow instructions specified by the manufacturer may result in serious consequences such as death, personal injury, or damage to equipment since the protection provided by the equipment may be impaired.

 **AVERTISSEMENT**

FONCTIONNEMENT INATTENDU DE L'EQUIPEMENT

Ne dépassez aucune évaluation spécifiée dans le tableau de caractéristiques environnementales et électriques..

Le fait de ne pas suivre les instructions peut entraîner une défaillance de la protection fournie par l'équipement, ce qui peut entraîner des conséquences graves, comme des blessures ou des dommages à l'équipement.

3 Hardware Interface

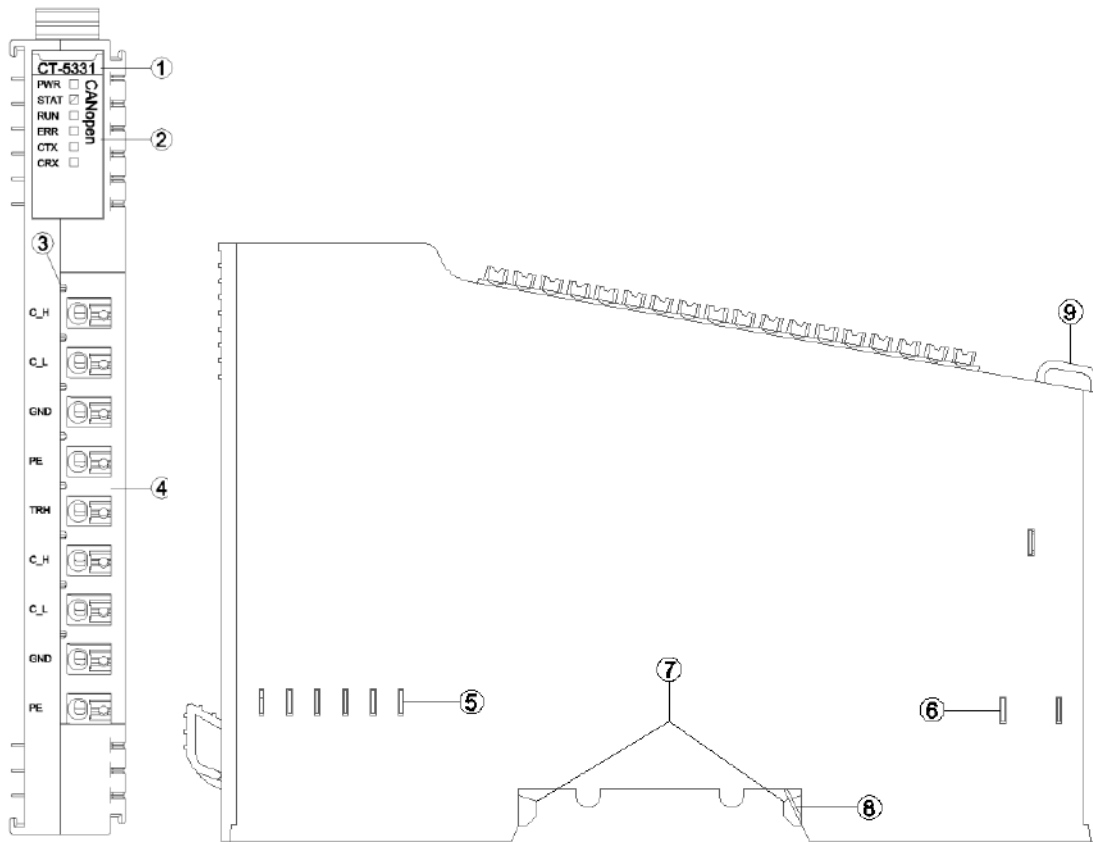

- ① Module Type
- ② State indicator
- ③ N/A
- ④ Wiring Terminal and identification
- ⑤ Internal Bus
- ⑥ Field Power
- ⑦ Buckle
- ⑧ Grounding Spring Sheet Fixed Wiring Harness
- ⑨ Fixed Wiring Harness

3.1 Wiring Terminal

Terminal	Location at Head, tail of the CAN bus	Location at middle of the CAN bus
C_H	CAN_H signal wire	CAN_H signal wire
C_L	CAN_L signal wire	CAN_L signal wire
GND	CAN signal earth	CAN signal earth
PE	Ground terminal	Ground terminal
TRH	Built-in terminal resistance	
C_H		CAN_H signal wire
C_L	N/A	CAN_L signal wire
GND		CAN signal earth
PE		Ground terminal

WARNING

UNEXPECTED EQUIPMENT OPERATION

Calculate the maximum field power current consumption of a single module based on the actual field load. If the total field power current consumption of all I/O modules exceeds the power supply capacity of the field power supply, you must add an extra power expansion module. Otherwise, an output channel exception may occur.

Failure to follow instructions specified by the manufacturer may result in serious consequences such as death, personal injury, or damage to equipment since the protection provided by the equipment may be impaired.

AVERTISSEMENT

FONCTIONNEMENT INATTENDU DE L'EQUIPEMENT

Calculez la consommation maximale de courant de champ d'un seul module en fonction de la charge de champ réelle. Si la consommation totale de courant de champ de tous les modules d'E/S dépasse la capacité d'alimentation de l'alimentation de champ, vous devez ajouter un module d'extension de puissance supplémentaire. Dans le cas contraire, une exception de canal de sortie peut se produire.

Le fait de ne pas suivre les instructions peut entraîner une défaillance de la protection fournie par l'équipement, ce qui peut entraîner des conséquences graves, comme des blessures ou des dommages à l'équipement.

When connecting a cold-pressed terminal, the terminal must be terminated and checked in strict accordance with the corresponding termination specifications or

requirements, and connect the cold-pressed terminal according to the corresponding node serial number. The conductor should use copper conductor and the conductor core should be larger than 0.2mm^2 and smaller than 1mm^2 (AWG18~AWG24). Cold-pressed terminal parameters are as follows:

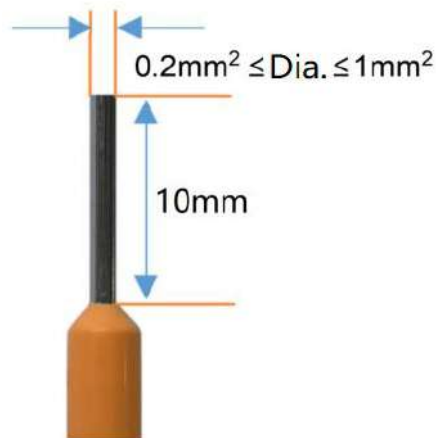

⚠️ WARNING

UNEXPECTED EQUIPMENT OPERATION

Strip the length of the conductor insulation layer is greater than 10mm to ensure reliable signal connection.

The wire needs to use copper wire and the wire core is greater than or equal to 0.2mm^2 and less than or equal to 1mm^2 to ensure reliable signal connection.

When connecting a cold-press terminal, connect the cold-press terminal strictly in accordance with the corresponding termination specifications or requirements, and connect the cold-press terminal according to the corresponding node serial number.

Do not power on cold-press terminals until they are properly connected or fully locked.

Failure to follow instructions specified by the manufacturer may result in serious consequences such as death, personal injury, or damage to equipment since the protection provided by the equipment may be impaired.

⚠️ AVERTISSEMENT

FONCTIONNEMENT INATTENDU DE L'EQUIPEMENT

Dépouillez la longueur de la couche isolante du fil plus de 10mm pour assurer la connexion fiable du signal.

Le conducteur doit utiliser le fil de cuivre et le noyau de fil est supérieur ou égal à $0,2\text{ mm}^2$, inférieur ou égal à 1mm^2 , afin d'assurer la connexion fiable du signal.

Lorsque les terminaux de presse à froid sont terminés, ils doivent être terminés et visualisés en

stricte conformité avec les spécifications ou les exigences correspondantes et terminés selon le numéro de série de noeud correspondant.

Il est interdit d'activer les bornes à froid avant qu'elles ne soient correctement articulées ou complètement verrouillées.

Le fait de ne pas suivre les instructions peut entraîner une défaillance de la protection fournie par l'équipement, ce qui peut entraîner des conséquences graves, comme des blessures ou des dommages à l'équipement.

DANGER

FIRE DANGER

Use the correct wiring rules only for the maximum current capacity of the I/O channel and power supply.

Failure to follow instructions specified by the manufacturer may result in serious consequences such as death, personal injury, or damage to equipment since the protection provided by the equipment may be impaired.

WARNING

UNEXPECTED EQUIPMENT OPERATION

Do not exceed any of the ratings specified in the environmental and electrical characteristics table.

Failure to follow instructions specified by the manufacturer may result in serious consequences such as death, personal injury, or damage to equipment since the protection provided by the equipment may be impaired.

AVERTISSEMENT

FONCTIONNEMENT INATTENDU DE L'EQUIPEMENT

Ne dépassez aucune évaluation spécifiée dans le tableau de caractéristiques environnementales et électriques..

Le fait de ne pas suivre les instructions peut entraîner une défaillance de la protection fournie par l'équipement, ce qui peut entraîner des conséquences graves, comme des blessures ou des dommages à l'équipement.

3.2 LED indicator definition

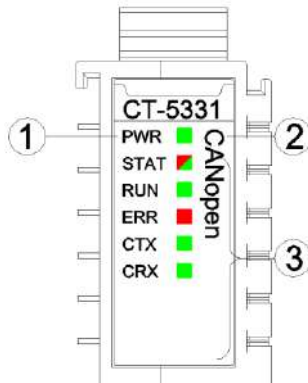

PWR power indicator (Green)	Definition
ON	The system power supply is normal.
OFF	The system power supply is failure.
STAT- Module State Indicator (Red/Green)	Definition
Double Flash (RED)	Module Exception has been soft-restarted
ON (GREEN)	Operational Mode
Green Single Flash	Stop mode
Flash(2.5Hz) (RED/GREEN)	Upgrading mode
Flash(10Hz) (RED/GREEN)	Firmware Update
RUN -Running status indicator (Green)	Definition
Flash(2Hz)	Pre-Operational status
Single flash	Stopped status
Steady on	operation status
ERR Error status indicator (red)	Definition
Single flash	CAN error frame reaches warning value
Double flash	Error control event
Steady on	Bus Off
OFF	Bus in normal
CTX CAN Sending indicator (Green)	Definition
Flash	CAN is sending data
OFF	CAN not sending data
CRX CAN Receiving indicator (Green)	Definition
Flash	CAN is receiving data
OFF	CAN not receiving data

! WARNING

UNEXPECTED EQUIPMENT OPERATION

By viewing the PW indicator, could determine the power supply status of a module. If the PW is steady green, the power supply is normal. Otherwise, the module cannot work properly.

When the module is initially powered on, there will be 3S for the backplane bus connection. After the backplane bus is initialized, STA is in the green steady state. If STA is in the green blinking state, it indicates that the backplane bus has not been initialized, and it needs to be powered off and restarted for re-initialization.

STA abnormal working state occurs during the normal operation of the module, please check the firmware version information of all modules, and consult ODOT technical support for details.

If a module is upgraded, check that all modules are in the normal state after the upgrade. Otherwise, an exception may occur.

Failure to follow instructions specified by the manufacturer may result in serious consequences such as death, personal injury, or damage to equipment since the protection provided by the equipment may be impaired.

AVERTISSEMENT

FONCTIONNEMENT INATTENDU DE L'EQUIPEMENT

En regardant l'état de l'indicateur de PW, jugez l'état d'alimentation du module. Le feu vert PW reste allumé et l'alimentation est normale. Autrement, le module ne fonctionnera pas correctement.

Lorsque le module est alimenté initialement, il y aura 3S pour la connexion de bus de backboard. STA est un état vert permanent après l'initialisation du bus de backboard. Si STA est en état de clignotement vert, cela signifie que l'initialisation du bus de backboard n'est pas passée et doit être redémarrée hors tension et réinitialisée.

L'état de fonctionnement anormal de STA se produit pendant le fonctionnement normal du module, veuillez vérifier les informations de version du firmware de tous les modules, et consulter le support technique ODOT pour plus de détails.

Si le module a une opération de mise à niveau, après l'achèvement de la mise à niveau, le besoin de vérifier que tous les modules sont dans l'état normal avant de courir, sinon il conduira à une exception.

Le fait de ne pas suivre les instructions peut entraîner une défaillance de la protection fournie par l'équipement, ce qui peut entraîner des conséquences graves, comme des blessures ou des dommages à l'équipement.

4 Wiring

CT-5331 set location at Head, tail of the CAN bus

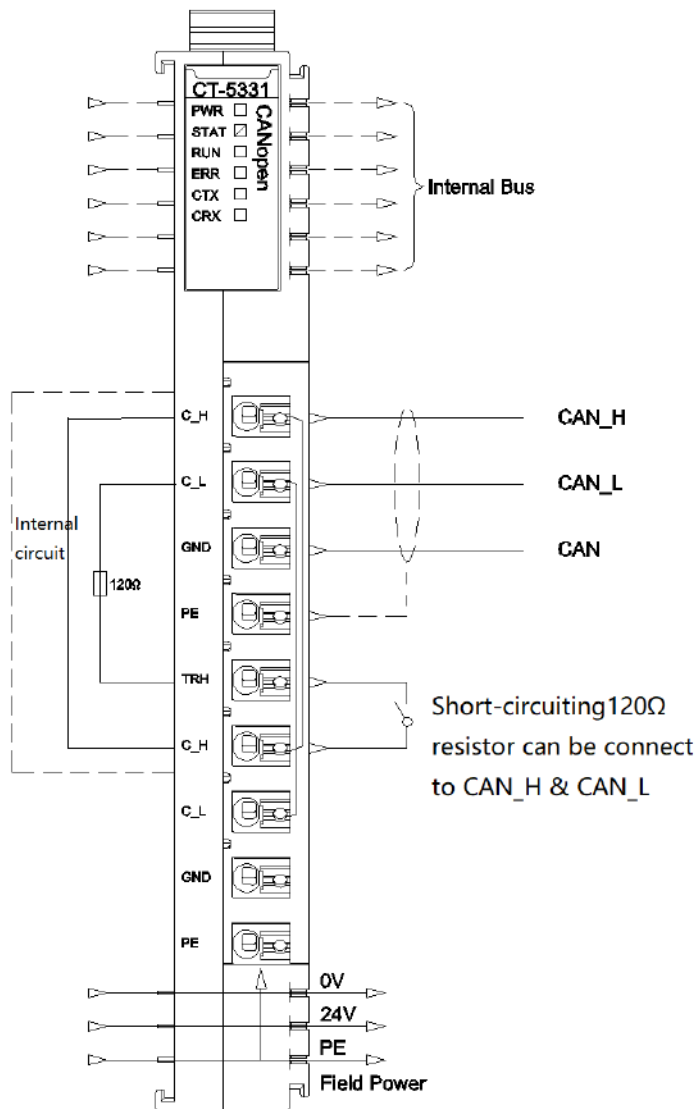

NOTICE

EQUIPMENT INOPERABLE

Do not crimp the spring terminal with more than the maximum pressure specified for the terminal. Otherwise, the resilience of the spring terminal may be damaged and the terminal rebound may be affected.

Do not press the spring terminal with a sharp tool when removing cable from the channel. Otherwise, the spring terminal will be damaged.

Failure to follow these instructions may result in equipment damage.

CT-5331 set location at middle of the CAN bus

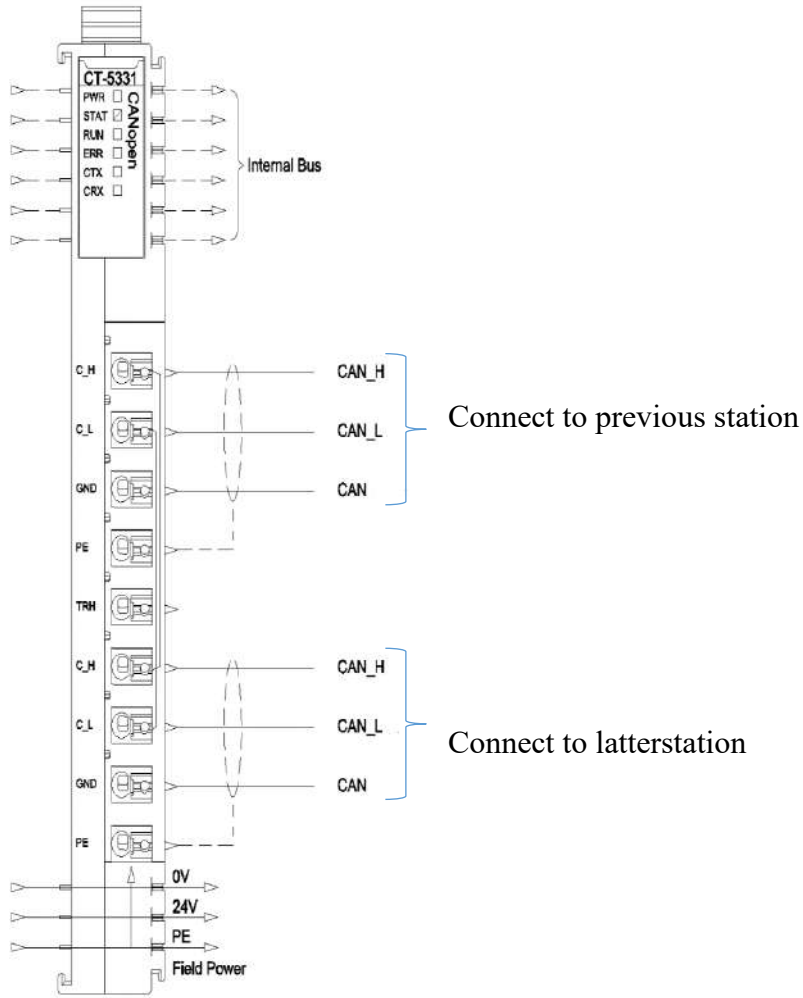

5 Process data definition

5.1 Module process data definition

CT-5331, the module itself has no input or output process data.

5.2 Submodule process data mapping

The network adapter reads and writes the input and output process data of the submodule of CT-5331 in real time through the internal bus.

6 Configuration parameters definition

6.1 CT-5331 Configuration parameter definition

Configuration parameter								
Bit No	Bit 7	Bit 6	Bit 5	Bit 4	Bit 3	Bit 2	Bit 1	Bit 0
BYTE0					Auto COB-ID	Auto PDO Number	Auto Start	CAN Mode
BYTE1	Manager Node ID							
BYTE2					CAN Baud Rate			
BYTE3								SYNC ENABLE
BYTE4	SYNC COBID							
BYTE5								
BYTE6	SYNC Cycle							
BYTE7								
BYTE8								
BYTE9								
BYTE10	SYNC Window Length							
BYTE11								
BYTE12								
BYTE13								
BYTE14	Heartbeat time							
BYTE15								
BYTE16	Consumer/Producer Heartbeat Ratio							
BYTE17								
BYTE18								
BYTE19								
BYTE20	SDO timeout							
BYTE21								

Working Mode: Module working mode (Default: CANopen Host/Master)

Auto Start: (Default : enable)

Auto Generate PDO Number: Automatically assign PDO serial number,

Enable or Disable are optional. (Default: enable)

Auto Generate PDO COB-ID: Automatically assign PDO COB-ID, Enable or

Disable are optional .(Default: enable)

Manager Node-ID: Manager node address (Default: 127)

CAN BaudRate: CAN Baud Rate (Default: 125KBit/sec)

0: 1MBit/sec

- 1: 800 KBit/sec
- 2: 500 KBit/sec
- 3: 250 KBit/sec
- 4: 125 KBit/sec
- 5: 100 KBit/sec
- 6: 50 KBit/sec
- 7: 20 KBit/sec
- 8: 10 KBit/sec

SYNC Enable: (Default: disable)

- 0: Disable
- 1: Enable

SYNC COB-ID: sync identifier (Default: 0x0800)

Communication Cycle Period (us) : 32-bit unsigned value can be set up.

(Default : 0)

Synchronnous Windows Length(us): 32-bit unsigned value can be set up

(Default: 0)

Manager Producer Heartbeat time(ms): 0~65535 can be set up. (Default: 1000)

Consumer/Producer Heartbeat Ratio: 1.5~10 can be set up (Default : 1.5)

SDO Response Timeout (ms): the master waits for the slave station to respond after sending commands : 100~2000 can be set up (Default : 500)

6.2 CT-5331 Parameter definitions for submodules

6.2.1 CANopen Slave station

The CT-5331 module supports mounting of 16 CANOPEN slave devices, each with 4 RPDos and 4 TPDos by default.

6.2.1.1 CANopen Slave station configure parameters

Configure Parameters								
Bit No	Bit 7	Bit 6	Bit 5	Bit 4	Bit 3	Bit 2	Bit 1	Bit 0
BYTE0	CAN Node ID							
BYTE1						State Machine Check	Auto Star	Error Control Protocol
BYTE2	Producer Heartbeat Time(ms)							
BYTE3								
BYTE4	Consumer Heartbeat Time Node ID							
BYTE5	Consumer/Producer Heartbeat Ratio							
BYTE6								
BYTE7								
BYTE8								
BYTE9	Guard Time(ms)							
BYTE10								
BYTE11	Life Time Factor							

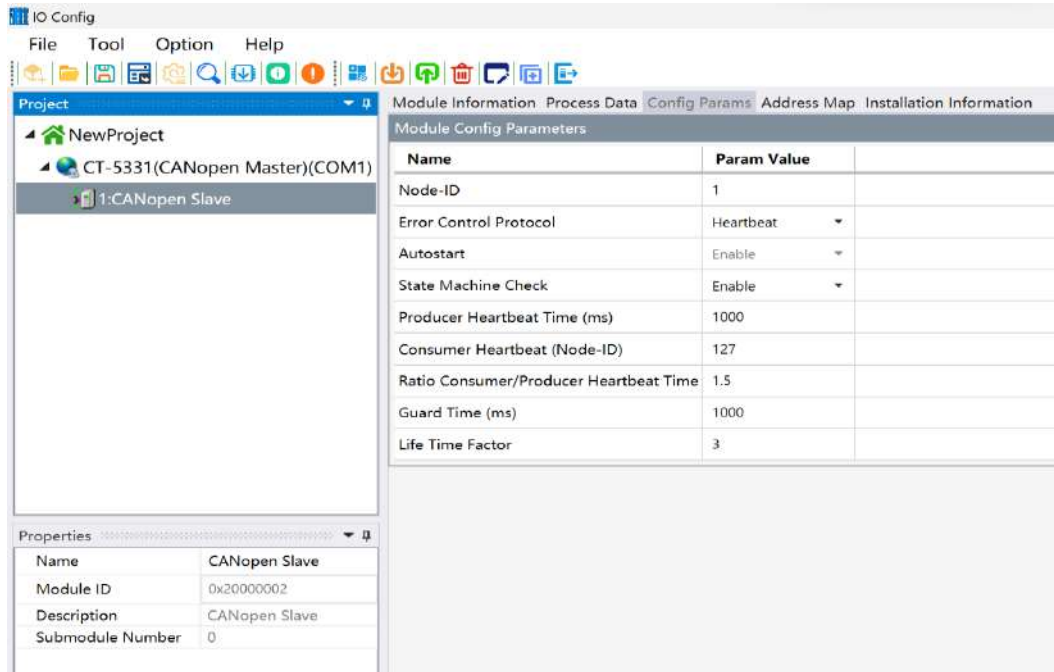

CAN Node ID: Can be set 1-127, Default :1

Error Control Protocol : Error control protocol, Heartbeat packet and node protection are optional, Default : Heartbeat

Auto Star : Automatically, Default: enable

State Machine Check: State machine check: Enable or disable (optional), Default: enable

Producer Heartbeat Time: Producer Heartbeat Time (ms),16 bits unsigned type, Default:1000

Consumer Heartbeat Time Node ID: can be set 0-127, Default :127

Consumer/Producer Heartbeat Ratio: Consumer/Producer Heartbeat Ratio,can be set 1.5-10 , Default :1.5

Guard Time: guard Time (ms), 6 bits unsigned type, Default :1000

Life Time Factor: Life Time ,8 bits unsigned type, Default : 3

6.2.1.2 CANopen Sub-module

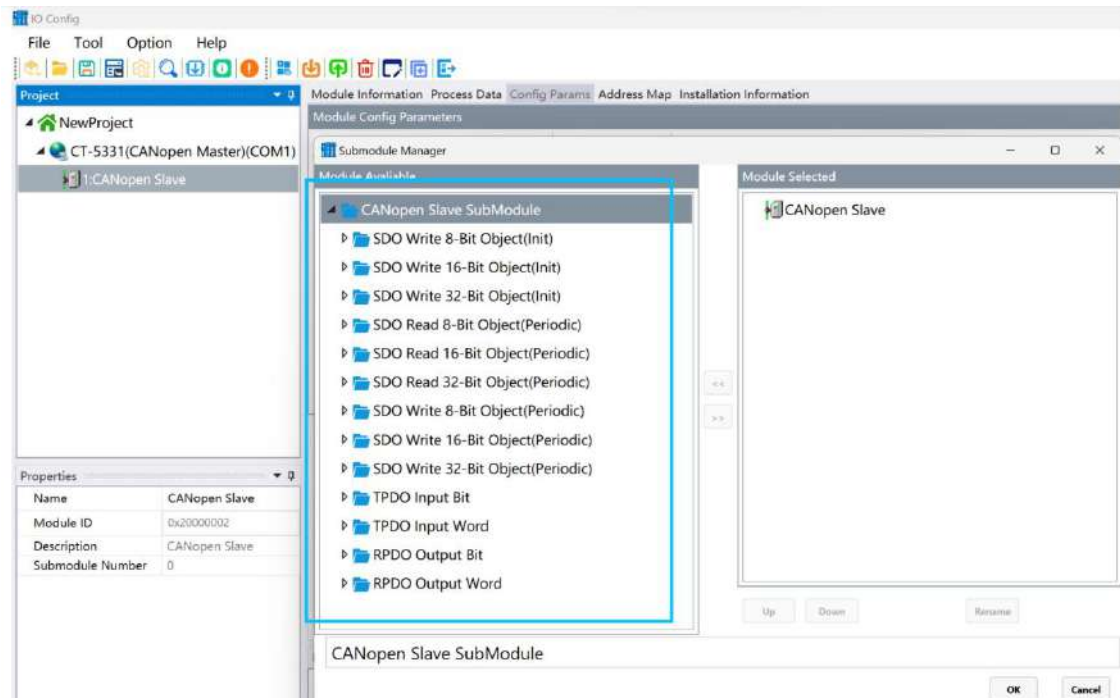

Contains:

SDO Write 8bit Object (Init) : include Write 1~8 8bit Objects

SDO Write16bit Object (Init) : include Write 1~8 16bit Objects

SDO Write 32bit Object (Init) : include Write 1~8 32bit Objects

SDO Read 8bit Object (Read Periodic) : include Read 1~8 8bit Objects

SDO Read 16bit Object (Read Periodic) : include Read 1~8 16bit Objects

SDO Read 32bit Object (Read Periodic) : include Read 1~8 32bit Objects

SDO Write 8bit Object (Write Periodic) : include Write 1~8 8bit Objects

SDO Write 16bit Object (Write Periodic) : include Write 1~8 16bit Objects

SDO Write 32bit Object (Write Periodic) : include Write 1~8 32bit Objects

TPDO data input (Bit variable) : include TPDO input 1~8 byte (bit)

TPDO data input (Word variable) : include TPDO input 1~8 byte (word)

TPDO data output (Bit variable) : include RPDO data input 1~8 byte (bit)

TPDO data output (Word variable) : include RPDO data input 1~8 byte (word)

1. SDO Init Write

The instruction configuration parameters include the object identifier (index + subindex + data length) and the initial value of the object.

Object Identifier: object identifier (index + subindex + data length)

Object Initial Value: Initial Value

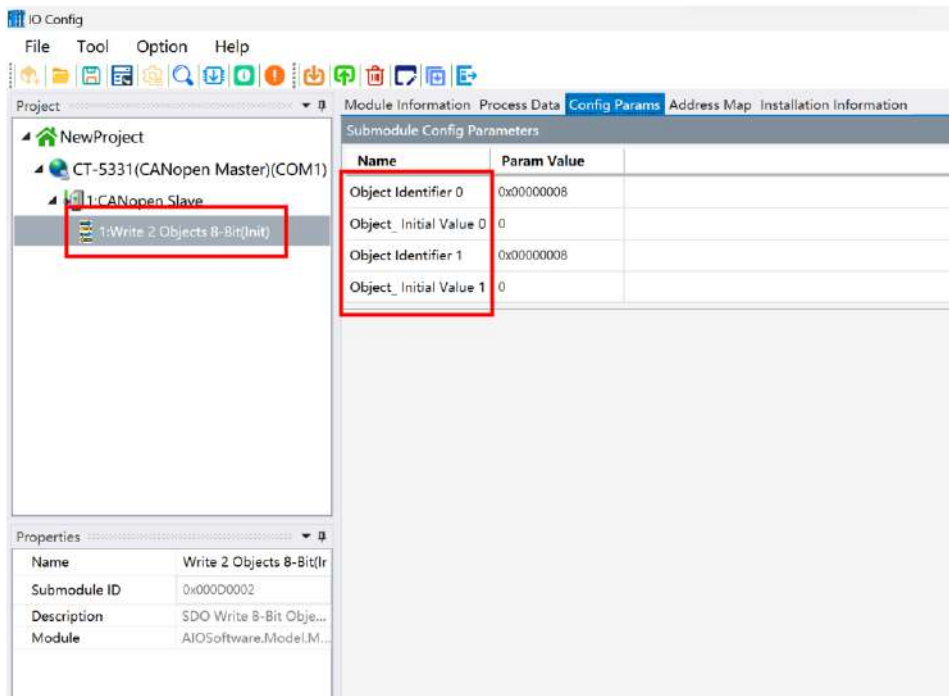

2. SDO Read Periodic, Write Periodic The instruction configuration parameters includes: Scan speed, object identifier (index + subindex + data length).

Scan Rate(ms) : Scan speed, Default :1000ms

Object Identifier: object identifier, (index + subindex + data length).

IO Config

File Tool Option Help

Project

- NewProject
 - CT-5331(CANopen Master)(COM1)
 - CANopen Slave
 - 1:Read 1 Object 8-Bit(Periodic)
 - 2:Read 2 Objects 8-Bit(Periodic)**
 - 3:Read 3 Objects 8-Bit(Periodic)

Module Information Process Data **Config Params** Address Map Installation Information

Submodule Config Parameters

Name	Param Value
Scan Rate (ms)	1000
Object Identifier 0	0x00000008
Object Identifier 1	0x00000008

Properties

Name	Read 2 Objects 8-Bit(Pe
Submodule ID	0x00010002
Description	SDO Read 8-Bit Objec...
Module	AIOSoftware.Model.M...

IO Config

File Tool Option Help

Project

- NewProject
 - CT-5331(CANopen Master)(COM1)
 - CANopen Slave
 - 1:Read 1 Object 8-Bit(Periodic)
 - 2:Read 2 Objects 8-Bit(Periodic)
 - 3:Read 3 Objects 8-Bit(Periodic)
 - 4:Write 1 Object 8-Bit(Periodic)
 - 5:Write 2 Objects 8-Bit(Periodic)
 - 6:Write 3 Objects 8-Bit(Periodic)
 - 7:Write 4 Objects 8-Bit(Periodic)
 - 8:Write 5 Objects 8-Bit(Periodic)
 - 9:Write 2 Objects 16-Bit(Periodic)
 - 10:Write 2 Objects 16-Bit(Periodic)**

Module Information Process Data **Config Params** Address Map Installation Information

Submodule Config Parameters

Name	Param Value
Scan Rate (ms)	1000
Object Identifier 0	0x00000010
Object Identifier 1	0x00000010

Properties

Name	Write 2 Objects 16-Bit(
Submodule ID	0x00060002
Description	SDO Write 16-Bit Obj...
Module	AIOSoftware.Model.M...

3. TPDO data input Configuration parameters

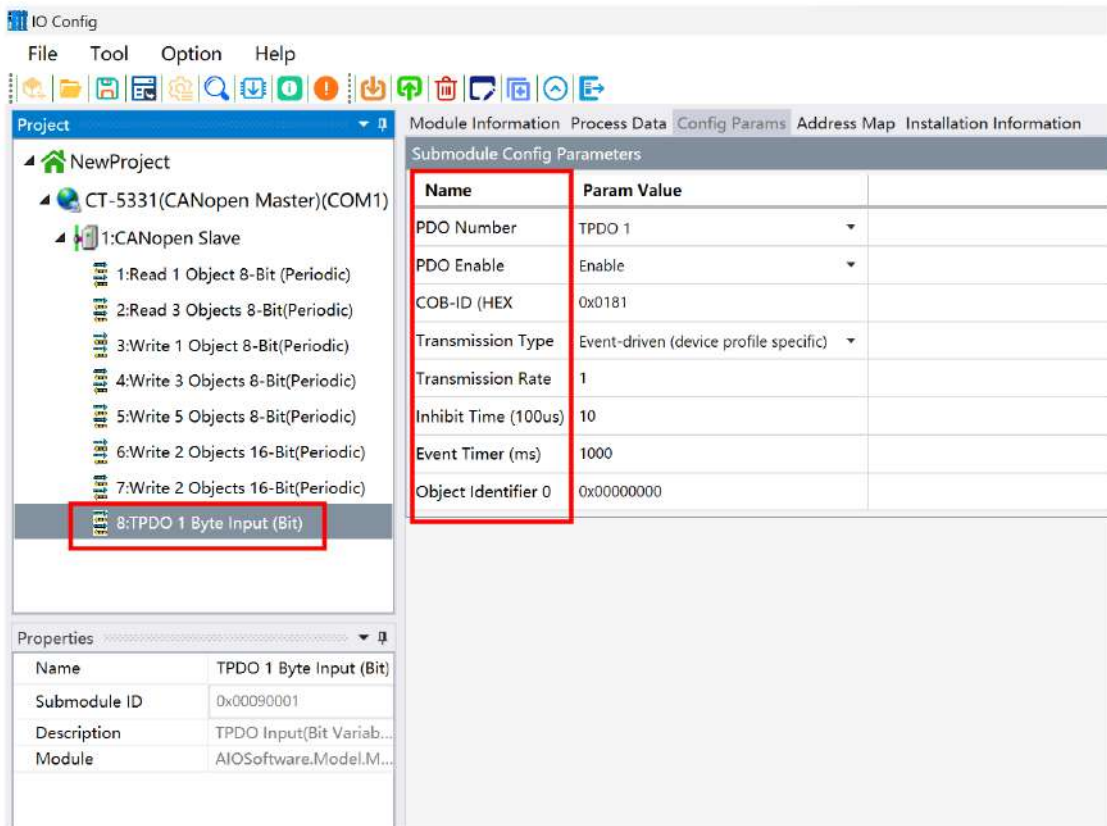

TPDO Number: TPDO1, TPDO2, TPDO3.....TPDO64

PDO Enable: Enable or disable (optional), Default: enable

COB-ID(HEX): 16#0x180+Node_ID

Transmission Type : Synchronous (acyclic) , Synchronous (cyclic) Event-driven(manufacture specific), Event-driven(device profile specific) can optional , Default: Event-driven (device profile specific)

Transmission Rate: 8bit unsigned type, Default: 1

Inhibit Time(100us): inhibit time (100us) , 16bit unsigned type, Default: 10

Event Timer: event timer (ms), 16 bits unsigned type, Default: 1000

Object Identifier: object identifier, (index + subindex + data length).

4. RPDO data output Configuration parameters

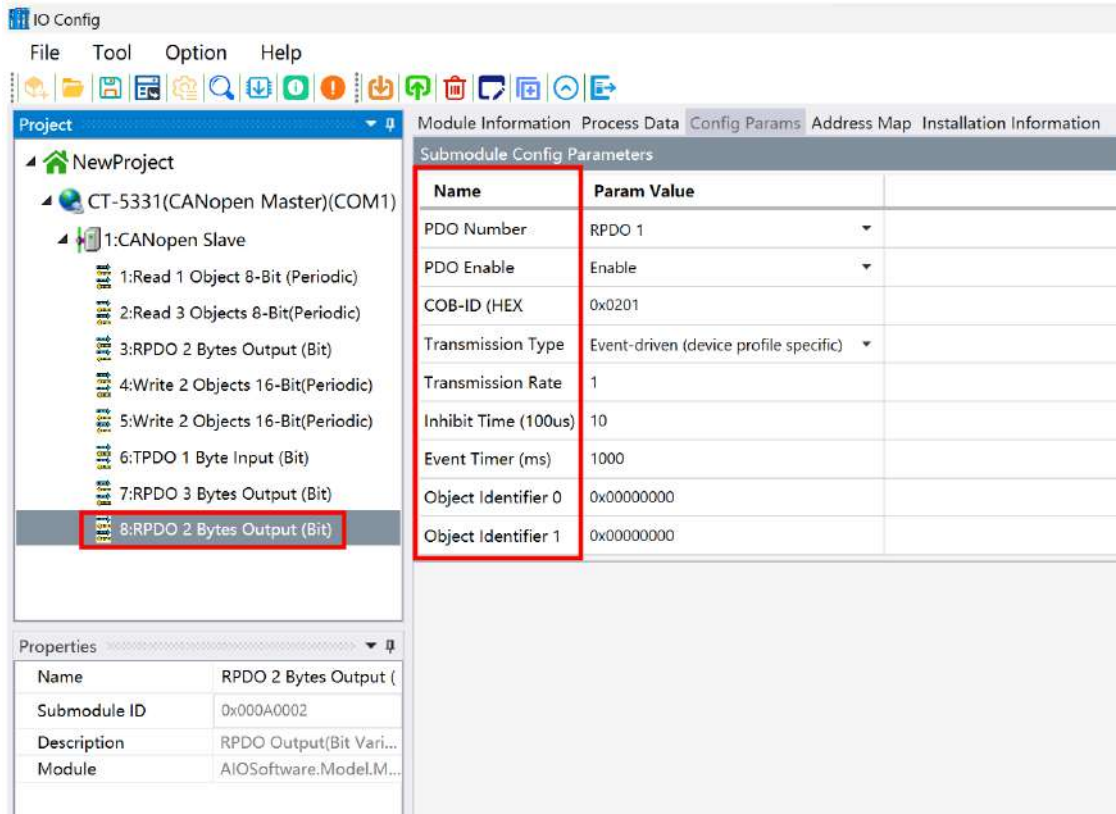

RPDO Number: RPDO1, RPDO2, RPDO3.....RPDO64

PDO Enable: enable, disable can optional, Default: enable

COB-ID(HEX): 16#0x200+Node_ID

Transmission Type: Synchronous (acyclic), Synchronous (cyclic) Event-driven (manufacture specific), Event-driven (device profile specific) can be optional, Default: Event-driven (device profile specific)

Transmission Rate: 8bit unsigned type, Default: 1

Inhibit Time(100us): inhibit time (100us), the minimum interval between two PDO transmissions ,16bit unsigned type, Default: 10

Event Timer (ms) ,16bit unsigned type, Default: 1000

Object Identifier: Object identifier (index + subindex + data length).

6.2.2 EMCY control module

EMCY Control module configuration parameters: EMCY override forbid, enable can

be optional, Default: disable.

An emergency packet is triggered by a fatal error inside the device and sent by the related application device to another device with the highest priority. Error alarm signal for interrupt type.

An emergency message consists of 8 bytes in the following format:

sender →receiver(s)

COB-ID	Byte0-1	Byte2	Byte3-7
0x080+Node_ID	Error Code	Error Register (Object 0x1001)	Manufacture-specific error area

Table 3-5 lists the hexadecimal emergency error code, The ‘xx’ parts of the emergency error code is defined by the corresponding device subprotocol.

Table 3-5 emergency error code (hexadecimal)

Emergency error code	Code function description
00xx	Error Reset or No Error
10xx	Generic Error
20xx	Current
21xx	Current, device input side
22xx	Current, inside the device
23xx	Current, device output side
30xx	Voltage
31xx	Mains voltage
32xx	Voltage inside the device
33xx	Output voltage
40xx	Temperature
41xx	Ambient temperature
42xx	Device temperature
50xx	Device hardware
60xx	Device software
61xx	Internal software
62xx	User software
63xx	Data set

70xx	Additional modules
80xx	Monitoring
81xx	communication
8110	CAN overrun
8120	Error Passive
8130	Life Guard Error or Heartbeat Error Or Heartbeat Error
8140	Recovered from Bus-Off
82xx	Protocol Error
8210	PDO no processed Due to length error Due to length error
8220	Length exceeded
90xx	External error
F0xx	Additional functions
FFxx	Device specific

The error register is in the object dictionary (index 0x1001) of the device. Table 3-6 shows the bit definition of the error register. The device can map internal errors into this status byte and provide a quick view of current errors.

Table 3-6: Bit Definitions for 8-Bit Error Register

Bit	Error Type
0	Generic
1	Current
2	Voltage
3	Temperature
4	Communication
5	Device profile specific
6	Reserved (=0)
7	Manufacturer specific

Manufacture-specific error fields may contain additional device-related error messages. The emergency message is triggered by a fatal error inside the device, and

is sent to other devices by the relevant application device with the highest priority.

This applies to the error alarm signal of the interrupt type.

The emergency alarm function can be realized by adding sub-module for the EMCY control module. The data address of the EMCY control module corresponds to the following:

Data Direction	Word Offset	Description	High Byte								Low Byte								Data Specification		
			7	6	5	4	3	2	1	0	7	6	5	4	3	2	1	0			
Input	0	Status word	EMCYDATA_Reset	Counter_Reset	Overflow_Reset	NonEmpty_Reset	/	Overflow	NonEmpty	/	NodeID										
	1	Overflow counter	Overflow_Couter																		
	2	EMCY data1	Error_Code																		
	3	EMCY data2	Manufacture_Data_0								Error_Register										
	4	EMCY data3	Manufacture_Data_2								Manufacture_Data_1										
Output	5	EMCY data4	Manufacture_Data_4								Manufacture_Data_3										
	0	Scan control word	EMCYDATA_Reset	Counter_Reset	Overflow_Reset	NonEmpty_Reset	/														
		Red: Read-only Blue: Feedback Green: Resettable	<p>Control Flow:</p> <ol style="list-style-type: none"> 1. Wait until the NonEmpty bit is set to 1, An urgent packet is received. 2. Read emergency message information NodeID, Error_Code, Error_Register, and Manufacture_Data to process alarm information. 3. Control output bit "NonEmpty_Reset" rising edge to clear the "Input NonEmpty" flag. 4. If the Overflow bit is set to 1, it indicates that urgent packets are discarded. Overflow_Couter indicates the number of discarded urgent packets. 5. Control the output bit Overflow_Reset, Counter_Reset rising edge to clear the input Overflow, Overflow_Couter. 6. It could control the rising edge of the output bit EMCYDATA_Reset to clear urgent packets NodeID, Error_Code, Error_Register, and Manufacture_Data. 																		

Notes: Blue: feedback, Green: resettable

Control Flow:

- 1.The input bit “non-Empty” is set to “1” indicates “Received 1 urgent message”.
- 2.Read emergency message information “Node ID, Error Code, Error Register, Manufacture Data,” and handle alarm information
- 3.Control the rising edge of the output bit “Non-Empty Reset” to clear the input mark “non-Empty”.
- 4.If the input bit “Overflow” is set to “1”, it means that there are currently urgent messages being discarded. “Overflow Couter” indicates the number of discarded urgent messages.
- 5.Control the rising edge of the output bits “Overflow Reset, Counter Reset” to clear the input marks “Overflow, Overflow Couter”.
- 6.The emergency message information “Node ID, Error Code, Error Register, Manufacture Data” can be cleared by controlling the rising edge of the output bit “EMCYDATA Reset”.

6.2.3 NMT - Network Management

CANopen NMT network management function can be realized by reading and writing the NMT control field in the “System Control Area”.

The NMT command word is a network management control command, and the valid command word values are as follows:

0x01: start the remote node

0x02: stop the remote node

0x80: enter the pre-operation state

0x81: reset node

0x82: reset communication

Writing other NMT command values will be ignored. When the trigger bit changes from “0” to “1”, an NMT command will be sent. The NMT slave address is the address of the remote node. The value is “1-127”, and “0” represents the broadcast address.

The NMT status contains the current status of all slaves in the current network **(to obtain a valid slave status, the error control function “Node Guarding” or “Heartbeat” of the slave must be activated)**. The status content of the slave station is read-only, and any value written will be ignored. The status corresponding to the status value is shown in **“Table 7”**. The initialization state means that the master has received the “Boot-up” startup message from the slave station. If the slave station is offline, it means that the master has timed out in querying the status of the slave station or receiving the heartbeat packet from the slave station. When receiving the status information from the slave station, there are stop, operation and pre-operation three states. Unknown status means that no slave status information was received.

Table 7. Slave Status List

Status Value	Node Status
0x00	Initialization status
0x01	Offline status
0x04	Stop status
0x05	Operation status
0x7F	Pre-operation status
0x0F	Unknown status

The control function of the slave station status can be realized by adding the sub-module for the NMT network management module.

The data address of the NMT network management module is shown in the figure below:

Data Direction	Word Offset	Description	High Byte								Low Byte								Data Specification					
			Bit	7	6	5	4	3	2	1	0	7	6	5	4	3	2	1		0				
Input	0	NMT (Control Word)	NMT (Command Word)								0->1 Trigger bit NodeID: 0 (Broadcast Address)								Output NMT control word feedback					
Output	0	NMT (Control Word)	NMT(Command Word)								0->1 Trigger bit NodeID: 0 (Broadcast Address)								NMT Control Word					
	Blue: Feedback	Control Flow: 1. NodeID Specifies the node address to be operated, 0 indicates the broadcast address. 2. Assign the NMT command word. 3. Trigger bit 0->1 Rising edge triggers the NMT command to be sent.																						

Notes: (Blue): Data feedback

Control Flow:

1. “Node ID” node address assignment indicates the node ID to be operated, and “0” represents the broadcast address.
2. “NMT” command word assignment.
3. Trigger bit “0->1” indicates that the rising edge triggers the sending of “NMT” command.

6.2.4 SDO Control module

The online read and write function of SDO can be realized by reading and writing to the SDO control domain in the "System Control area". The specific encoding format of the data is shown in Table 9.

Table 9.SDO Control register encoding format

Data Direction	Word Offset	Description	High Byte								Low Byte								Data Specification
			7	6	5	4	3	2	1	0	7	6	5	4	3	2	1	0	
Input	0	Index	Index																
	1	Node ID'	NodeID								SubIndex								
	2	Control word	Abort_Code_Reset	Done_Reset	Error_Reset	Abort_Code_3	SDO_Done	SDO_Error	SDO_Busy	Trigger	RW_Type	Byte_Len	Abort_Code_2	Abort_Code_0					
	3	Stop Code	Abort_Code_1								Abort_Code_0								
	4	SDO data1	SDO_Data_1																
	5	SDO data1	SDO_Data_1																
Output	20	SDO data16	SDO_Data_16																
	0	Index	Index																
	1	Node ID'	NodeID								SubIndex								
	2	Control word	Abort_Code_Reset	Done_Reset	Error_Reset	Abort_Code_3	SDO_Done	SDO_Error	SDO_Busy	Trigger	RW_Type	Byte_Len	Abort_Code_2	Abort_Code_0					
	3	SDO data 1	SDO_Data_1																
	4	SDO data 1	SDO_Data_1																
	18	SDO data16	SDO_Data_16																
Red: Control Flow Read-only Blue: A: Reading a Flow 1. Index/SubIndex/NodeID (Set object Index/ sub-index/node address information). Orange: 2. Set RW_Type to 0, it indicates the SDO upload. Feedback: 3. Set the Trigger bit to trigger the rising edge, and the SDO transmission starts, and then the SDO_Busy bit is forced to 1. conditional feedback: 4. The user waits for SDO_Done to complete to force bit to 1. 5. If SDO_Error and Abort_Code are 0 in SDO transmission, Byte_Len stores the byte length of read object data, and SDO_Data stores the object value. The effective byte length is Byte_Len. Green: 6. If the SDO transfer fails, the SDO_Error bit is set to 1, and the Abort_Code stores the abort_code, indicating the reason for the failure. Byte_Len and SDO_Data are cleared. Resettable: 7. Control the rising edge of the Done_Reset/Error_Reset bit to clear the SDO_Done/SDO_Error flag bit to start the next transmission. 8. It could control the Abort_Code_Reset bit rising edge to clear the Abort_Code as error code. B: Writing a Flow 1. Index/SubIndex/NodeID (Set object Index/ sub-index/node address information). 2. Set RW_Type to 1, it indicates SDO download, and set output Byte_Len/SDO_Data (output data length and output data value). The output value will be fed back to the corresponding input value. 3. Set the Trigger bit to trigger the rising edge, and the SDO transmission starts, and then the SDO_Busy bit is forced to 1. 4. The user waits for SDO_Done to complete to force bit to 1. 5. If the SDO transmission is normal, and SDO_Error and Abort_Code will be 0. 6. If the SDO transmission fails and the SDO_Error bit forced to 1, and the Abort_Code will store the abort_code, and it will indicate the reason for the failure. 7. Control the rising edge of the Done_Reset/Error_Reset bit to clear the SDO_Done/SDO_Error flag bit to start the next transmission. 8. It could control the Abort_Code_Reset bit rising edge to clear the Abort_Code as error code.																			

Notes: Red: Read-only, Blue: feedback, Orange: conditional feedback, Green: resettable.

Index of the object. Sub Index indicates the parameter of the object to be accessed. The SDO server slave number has a valid address range of 1-127.

The object dictionary Data Type is defined as shown in Table 10.

Table 10 object dictionary Data Type

Number	Data Type
0x01	BOOLEAN
0x02	INTEGER8
0x03	INTEGER16
0x04	INTEGER32
0x05	UNSIGNED8
0x06	UNSIGNED16
0x07	UNSIGNED32
0x08	REAL32
0x09	VISIBLE STRING
0x0A	OCTET STRING
0x0B	UNICODE STRING
0x0C	TIME_OF_DAY
0x0D	TIM_DIFFERENCE

Control Flow:

A: Read Flow

1. Set object index/ Sub-index/Node address information (Index/Sub Index /Node ID)
2. Set RW type to “0”, SDO representing is “upload”.
3. Set the trigger by rising edge, SDO start of transfer, SDO_Busy showed “1”.
4. The user waits for SDO Done to complete position 1.
- 5.If SDO transfer normal ,SDO_Error and Abort Code are showed “0”, Byte_Len stores the byte length of the read object data, SDO_Data stores the value of the object, and the effective byte length is Byte_Len.
- 6.If SDO transfer fails, SDO_Error showed “1” Abort_Code stores the abort code, indicating the cause of the failure. Byte_Len and SDO_Data are cleared.
7. Control the rising edge of the Done_Reset/Error_Reset to clear the SDO_Done/SDO_Error flag bit so that the next transmission can begin.
8. Control the Abort_Code_Reset bit rising edge to clear the Abort_Code error.

B: Write Flow

1. Set object index/ Sub-index/Node address information (Index/Sub Index /Node ID)
2. Set RW type to “1”, SDO representing is “download” , Set the output data length and output data Byte_Len/SDO_Data, and the output value will be feedback to the corresponds input value.
3. Set the trigger by rising edge, SDO start of transfer, SDO_Busy showed “1”.
4. The user waits for SDO Done to complete position 1.
5. If the SDO transfer normal ,SDO_Error and Abort Code are showed “0”,
If the SDO transfer fails, SDO_Error bit is set to 1, and the Abort_Code stores the abort code, indicating the reason for the failure.
7. Control the rising edge of the Done_Reset/Error_Reset to clear the SDO_Done/SDO_Error flag bit so that the next transmission can begin.
8. Control the Abort_Code_Reset bit rising edge to clear the Abort_Code error.

6.2.5 Network Scanned Module

The scanned module of nodes includes:

Network scanning module has 8 nodes

Network scanning module has 16 nodes

Network scanning module has 32 nodes

Network scanning module has 64 nodes

Network scanning module has 126 nodes

There are a maximum of 127 nodes on the CANopen network, and the gateway itself occupies one node address. The network scan function allows you to scan the basic information of the slave devices on the CANopen network.

The network scanning function is realized by adding the network scanning module.

Network scanning module data address mapping is as follows:

Data Direction	Word Offset	Description Bit	High Byte								Low Byte								Data Specification							
			7	6	5	4	3	2	1	0	7	6	5	4	3	2	1	0								
Input	0	Scan status word	Module information has scanned number of network nodes								/								Scanning	0->1 Trigger bit	The blue data bit is the output feedback value.					
	1	Module information	Node ID								Node state machine															
	2	Module information	Node ID								Node state machine															
	-	-																								
	126	Module information	Node ID								Node state machine															
Output	0	Scan Control word	/								/									0->1 Trigger bit	Scanning start trigger bit.					
		Red: Read-only Blue: Feedback	Control Flow: 1. The output trigger bit 0->1 rises to start scanning. 2. When the scanning status is set to 1, the number of nodes and module information are cleared. 3. Wait until the scan is completed, and then status is cleared. 4. The number of nodes contains the number of all nodes detected on the current network, and the ID and state machine information of storage nodes in the module information.																							

Notes: Green: read-only; Blue: Feedback

Control Flow:

1. The output trigger bit 0->1 rises to start scanning.
2. When the status is set to 1, the number of nodes and module information are cleared.
3. Wait until the scanning is completed, and the status bit is cleared.
4. The number of nodes contains the number of all nodes detected on the current network, and the ID and state machine information of storage nodes in the module information.

A Dimension drawing

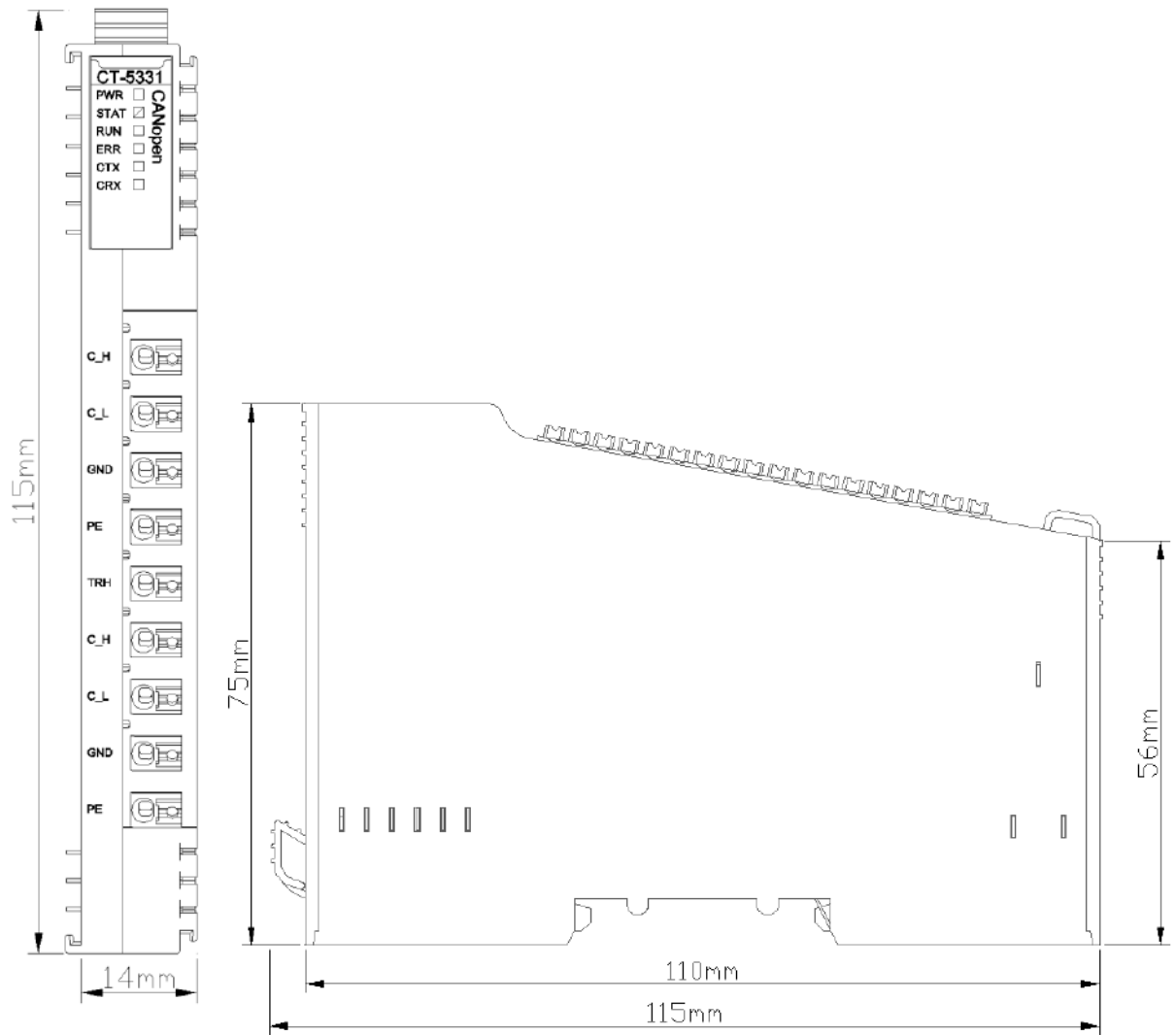

CT-5341 Profibus DP Master module

1 Module Description

The Profibus-DP master module supports 1 DP interface, supports the standard PROFIBUS-DP V0/V1 protocol, and supports the Profibus-DP master working mode. In combination with the adapter module, the Profibus-DP protocol can be converted to other protocols, such as ModbusTCP, Profinet, EtherCAT, Ethernet/IP, etc. When using the module, it is necessary to configure the process data reading and writing instructions, diagnostic instructions, configuration information, and configuration parameters of the Profibus-DP bus in the IO Config software.

All slave devices that support the Profibus-DP protocol can use this module to realize the interconnection with the upper PLC or the upper computer. Such as: PLC, DCS, remote IO, inverter, motor start protection device, intelligent high and low voltage electrical appliances, power measurement device, intelligent field measurement equipment and instruments, etc.

Note: When the DP master module is configured with DP Config software, it needs to be connected to a separate serial port cable, and the interface is on the side of the module.

2 Technical Parameters

General Parameters	
Power	Max.200mA@5.0VDC
Isolation	DP communication twisted pair and system power supply isolation voltage: AC 500V DP communication twisted pair with PE isolation voltage: AC 500V
Wiring Wire Diameter	Max.: AWG 18 Min.: AWG 24
Installation:	35mm DIN-Rail
Size	115*14*75mm
Weight	62g
Vibration Resistance	Comply with IEC 61131-2 and EC 60068-2-6
Impact Resistance	Comply with IEC 61131-2 and IEC 60068-2-27
EMC Performance	Comply with IEC 61131-2 and IEC 61000-4
Environmental Parameters	
Horizontal Installation Operating Temperature	-35°C~70°C
Vertically Installation Operating Temperature	-35°C~60°C
Relative Humidity	< 95% RH non-condensing
Storage Temperature	-40°C~85°C
Storage Humidity	< 95% RH non-condensing
Manufacturing Test Temperature	-40°C~75°C
Ingress Protection Rating	IP20
PROFIBUS-DP Parameters	
Channel	1 way
Interface	Terminal wiring
Protocol	Profibus-DP V0/V1
Station	Profibus-DP master
Station Address	Configured by IO configure software
Topology	Linear topology with termination resistors
Number of Slaves Supported	The extension module can carry with 32 slaves, and with repeaters it can be expanded to 125 slaves
Baud Rate	9.6k/19.2k/45.45k/93.75k/187.5k/500k/1.5M/3M/6M/12M (bps)
Max. Communication Distance	1000m
The Max. Length of the I/O Process Data	Max. Input: 1400 bytes, Max. Output: 1400 bytes The max. sum of input and output is 2800 bytes.

 **WARNING**

UNEXPECTED EQUIPMENT OPERATION

Do not exceed any of the ratings specified in the environmental and electrical characteristics table.

Failure to follow instructions specified by the manufacturer may result in serious consequences such as death, personal injury, or damage to equipment since the protection provided by the equipment may be impaired.

 **AVERTISSEMENT**

FONCTIONNEMENT INATTENDU DE L'EQUIPEMENT

Ne dépassez aucune évaluation spécifiée dans le tableau de caractéristiques environnementales et électriques..

Le fait de ne pas suivre les instructions peut entraîner une défaillance de la protection fournie par l'équipement, ce qui peut entraîner des conséquences graves, comme des blessures ou des dommages à l'équipement.

3 Hardware interface

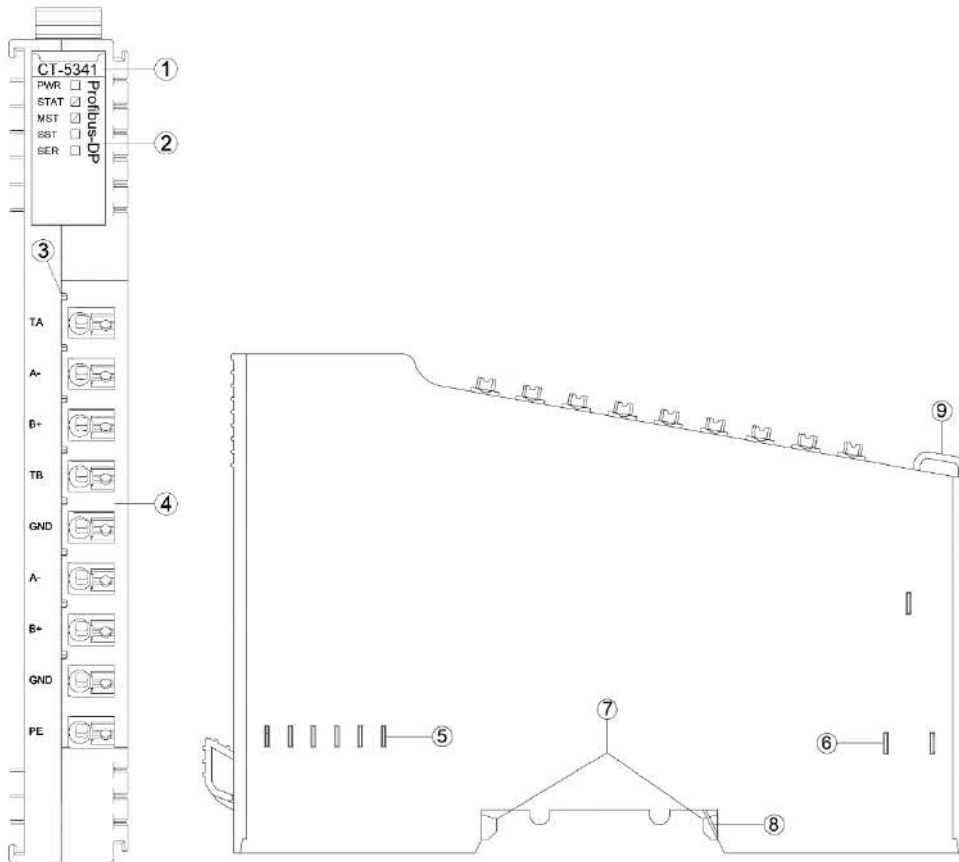

- ① Module Type
- ② State Indicator
- ③ N/A
- ④ Wiring Terminal and Identification
- ⑤ Internal Bus
- ⑥ Field Power
- ⑦ Buckle
- ⑧ Grounding Spring Sheet
- ⑨ Fixed Wiring Harness

3.1 Wiring Terminal

Terminal	At the head and tail of the DP bus	In the middle of the DP bus
TA	Built-in terminal resistance	N/A
A-		DP_A signal wire
B+		DP_B signal wire
TB		N/A
GND	Signal grounding	Signal grounding
A-	DP_A signal wire	DP_A signal wire
B+	DP_B signal wire	DP_B signal wire
GND	Signal grounding	Signal grounding
PE	Grounding terminal	Grounding terminal

WARNING

UNEXPECTED EQUIPMENT OPERATION

Calculate the maximum field power current consumption of a single module based on the actual field load. If the total field power current consumption of all I/O modules exceeds the power supply capacity of the field power supply, you must add an extra power expansion module. Otherwise, an output channel exception may occur.

Failure to follow instructions specified by the manufacturer may result in serious consequences such as death, personal injury, or damage to equipment since the protection provided by the equipment may be impaired.

AVERTISSEMENT

FONCTIONNEMENT INATTENDU DE L'EQUIPEMENT

Calculez la consommation maximale de courant de champ d'un seul module en fonction de la charge de champ réelle. Si la consommation totale de courant de champ de tous les modules d'E/S dépasse la capacité d'alimentation de l'alimentation de champ, vous devez ajouter un module d'extension de puissance supplémentaire. Dans le cas contraire, une exception de canal de sortie peut se produire.

Le fait de ne pas suivre les instructions peut entraîner une défaillance de la protection fournie par l'équipement, ce qui peut entraîner des conséquences graves, comme des blessures ou des dommages à l'équipement.

When connecting a cold-pressed terminal, the terminal must be terminated and checked in strict accordance with the corresponding termination specifications or requirements, and connect the cold-pressed terminal according to the corresponding node serial number. The conductor should use copper conductor and the conductor

core should be larger than 0.2mm² and smaller than 1mm² (AWG18~AWG24). Cold-pressed terminal parameters are as follows:

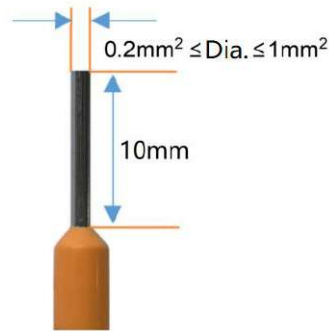

⚠️ WARNING

UNEXPECTED EQUIPMENT OPERATION

Strip the length of the conductor insulation layer is greater than 10mm to ensure reliable signal connection.

The wire needs to use copper wire and the wire core is greater than or equal to 0.2mm² and less than or equal to 1mm² to ensure reliable signal connection.

When connecting a cold-press terminal, connect the cold-press terminal strictly in accordance with the corresponding termination specifications or requirements, and connect the cold-press terminal according to the corresponding node serial number.

Do not power on cold-press terminals until they are properly connected or fully locked.

Failure to follow instructions specified by the manufacturer may result in serious consequences such as death, personal injury, or damage to equipment since the protection provided by the equipment may be impaired.

⚠️ AVERTISSEMENT

FONCTIONNEMENT INATTENDU DE L'ÉQUIPEMENT

Dépouillez la longueur de la couche isolante du fil plus de 10mm pour assurer la connexion fiable du signal.

Le conducteur doit utiliser le fil de cuivre et le noyau de fil est supérieur ou égal à 0,2 mm², inférieur ou égal à 1mm², afin d'assurer la connexion fiable du signal.

Lorsque les terminaux de presse à froid sont terminés, ils doivent être terminés et visualisés en stricte conformité avec les spécifications ou les exigences correspondantes et terminés selon le numéro de série de noeud correspondant.

Il est interdit d'activer les bornes à froid avant qu'elles ne soient correctement articulées ou complètement verrouillées.

Le fait de ne pas suivre les instructions peut entraîner une défaillance de la protection fournie par l'équipement, ce qui peut entraîner des conséquences graves, comme des blessures ou des dommages à l'équipement.

DANGER

FIRE DANGER

Use the correct wiring rules only for the maximum current capacity of the I/O channel and power supply.

Failure to follow instructions specified by the manufacturer may result in serious consequences such as death, personal injury, or damage to equipment since the protection provided by the equipment may be impaired.

WARNING

UNEXPECTED EQUIPMENT OPERATION

Do not exceed any of the ratings specified in the environmental and electrical characteristics table.

Failure to follow instructions specified by the manufacturer may result in serious consequences such as death, personal injury, or damage to equipment since the protection provided by the equipment may be impaired.

AVERTISSEMENT

FONCTIONNEMENT INATTENDU DE L'EQUIPEMENT

Ne dépassez aucune évaluation spécifiée dans le tableau de caractéristiques environnementales et électriques..

Le fait de ne pas suivre les instructions peut entraîner une défaillance de la protection fournie par l'équipement, ce qui peut entraîner des conséquences graves, comme des blessures ou des dommages à l'équipement.

3.2 LED indicator definition

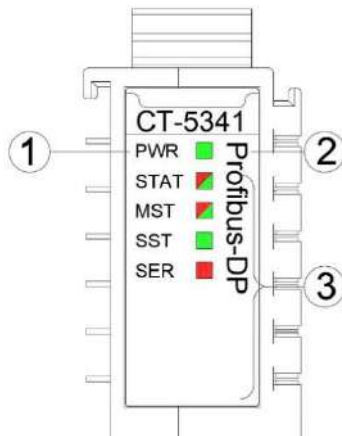

PWR Power Indicator(Green)	Definition
ON	The system power supply is normal
OFF	The system power supply is failure
STAT-Module State Indicator (Red/Green)	Definition
Double Flash (RED)	The module exception has been soft-restarted
ON (Green)	Operational Mode
Green Single Flash	Stop mode
Flash(2.5Hz) (RED/Green)	Upgrading mode
Flash(10Hz) (RED/Green)	Firmware Upgrading
Flash(2.5Hz) (RED)	Offline mode
MST DP Master Status indicator (Green/Red)	Definition
Flash(2.5Hz) (Green)	The DP master is starting up
ON(Green)	The DP master is operating normally
ON(RED)	The DP master is offline or faulty
Flash(10Hz) (RED)	The number of submodules or the length of the process data configuration is exceeded
SST DP Slave Status indicator (Green) SER DP Slave Error indicator (RED)	Definition
SST Flash, SER Flash	Upgrading mode
SST ON, SER OFF	No configuration parameters for the DP master
SST ON, SER OFF	All DP slaves are operating normally
SST OFF, SER ON	All DP slaves are offline or faulty
SST Flash, SER ON	Some DP slaves are offline or faulty

WARNING

UNEXPECTED EQUIPMENT OPERATION

By viewing the PW indicator, could determine the power supply status of a module. If the PW is

steady green, the power supply is normal. Otherwise, the module cannot work properly.

When the module is initially powered on, there will be 3S for the backplane bus connection. After the backplane bus is initialized, STA is in the green steady state. If STA is in the green blinking state, it indicates that the backplane bus has not been initialized, and it needs to be powered off and restarted for re-initialization.

STA abnormal working state occurs during the normal operation of the module, please check the firmware version information of all modules, and consult ODOT technical support for details.

If a module is upgraded, check that all modules are in the normal state after the upgrade. Otherwise, an exception may occur.

Failure to follow instructions specified by the manufacturer may result in serious consequences such as death, personal injury, or damage to equipment since the protection provided by the equipment may be impaired.

AVERTISSEMENT

FONCTIONNEMENT INATTENDU DE L'EQUIPEMENT

En regardant l'état de l'indicateur de PW, jugez l'état d'alimentation du module. Le feu vert PW reste allumé et l'alimentation est normale. Autrement, le module ne fonctionnera pas correctement.

Lorsque le module est alimenté initialement, il y aura 3S pour la connexion de bus de backboard. STA est un état vert permanent après l'initialisation du bus de backboard. Si STA est en état de clignotement vert, cela signifie que l'initialisation du bus de backboard n'est pas passée et doit être redémarrée hors tension et réinitialisée.

L'état de fonctionnement anormal de STA se produit pendant le fonctionnement normal du module, veuillez vérifier les informations de version du firmware de tous les modules, et consulter le support technique ODOT pour plus de détails.

Si le module a une opération de mise à niveau, après l'achèvement de la mise à niveau, le besoin de vérifier que tous les modules sont dans l'état normal avant de courir, sinon il conduira à une exception.

Le fait de ne pas suivre les instructions peut entraîner une défaillance de la protection fournie par l'équipement, ce qui peut entraîner des conséquences graves, comme des blessures ou des dommages à l'équipement.

4 Wiring

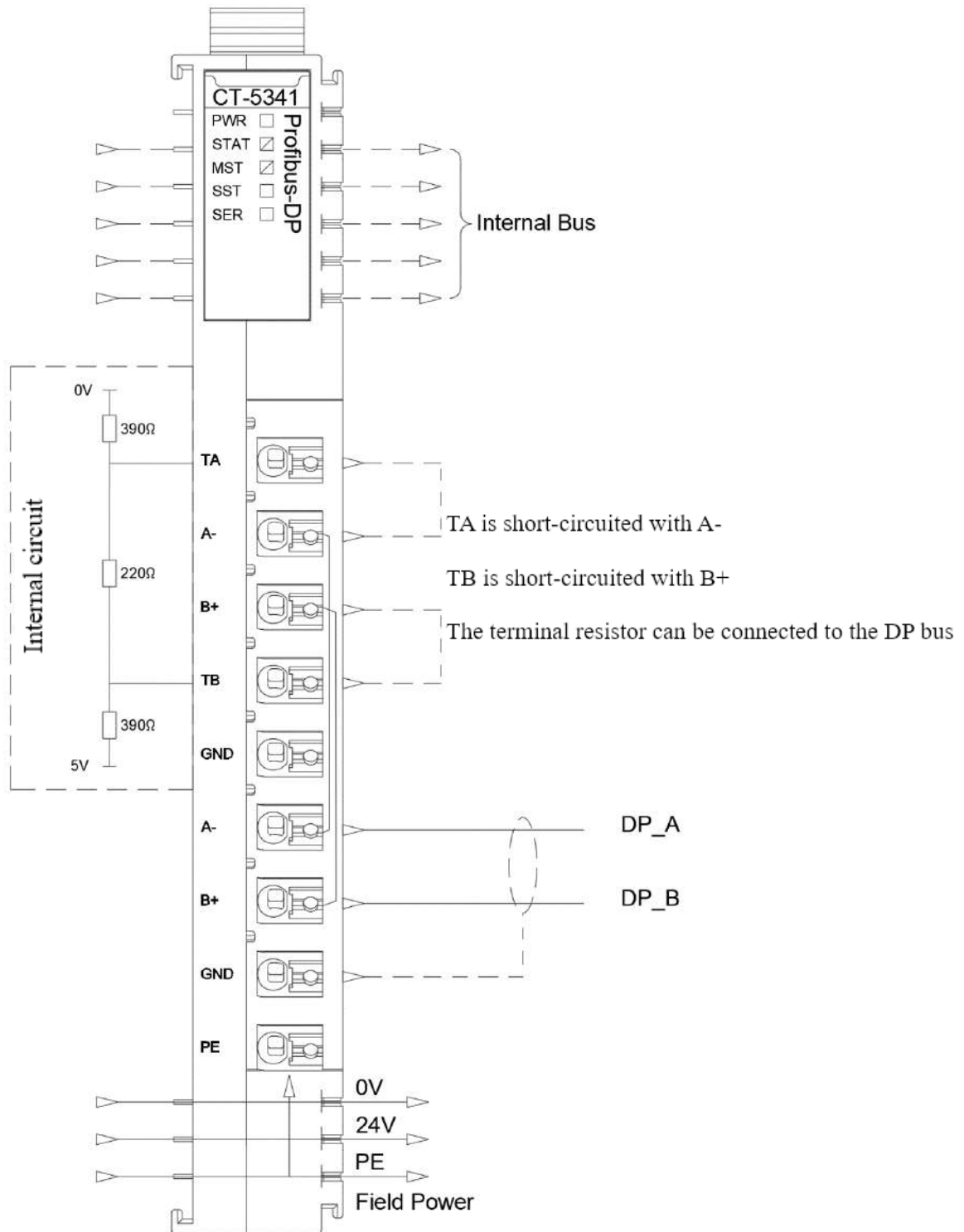

The module CT-5341 is at the head and tail of the DP bus

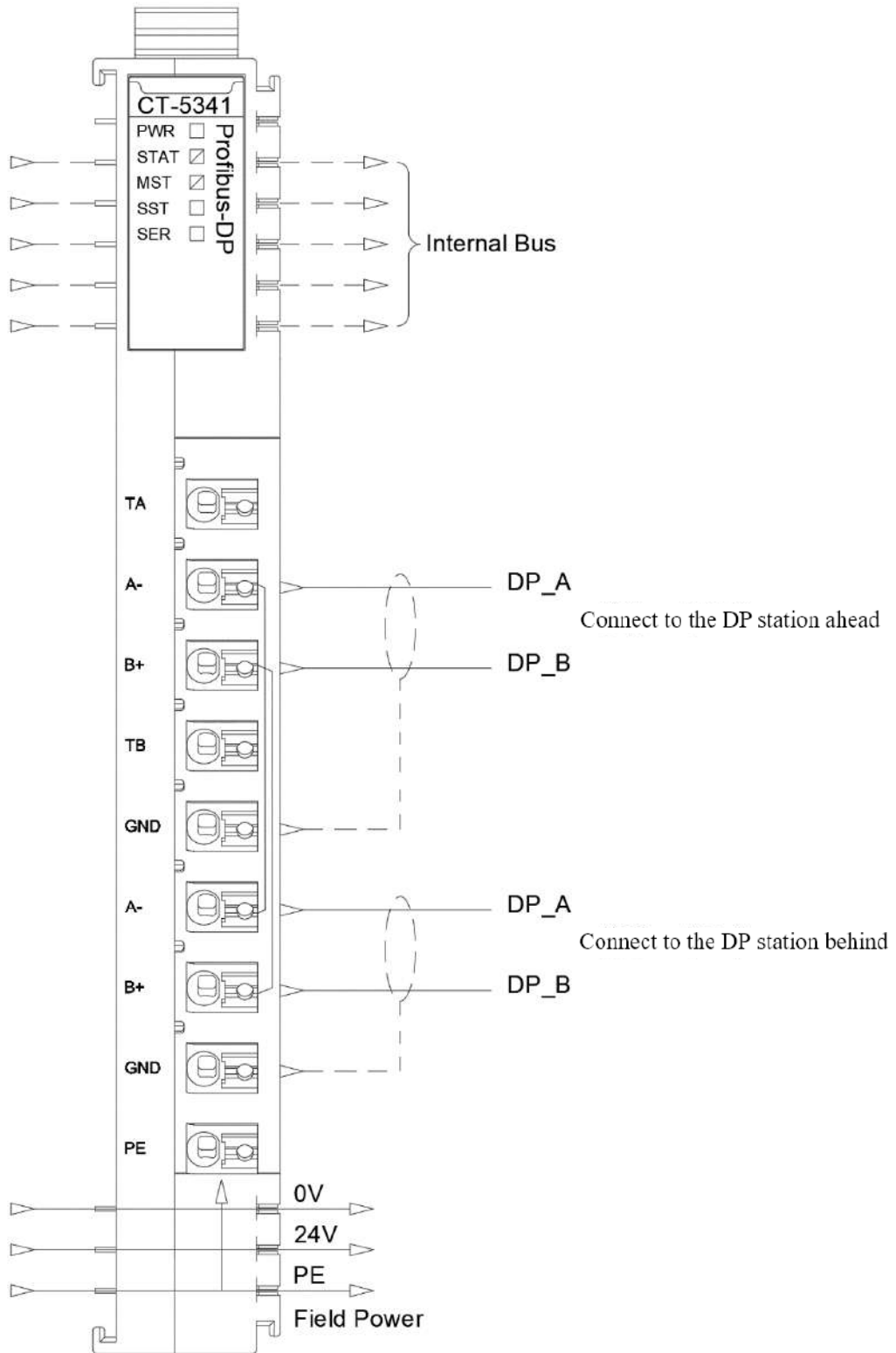

The module CT-5341 is in the middle of the DP bus

NOTICE

EQUIPMENT INOPERABLE

Do not crimp the spring terminal with more than the maximum pressure specified for the terminal. Otherwise, the resilience of the spring terminal may be damaged and the terminal rebound may be affected.

Do not press the spring terminal with a sharp tool when removing cable from the channel. Otherwise, the spring terminal will be damaged.

Failure to follow these instructions may result in equipment damage.

5 Process Data Definition

5.1 Module Process Data Definition

Sub-slot 0 of the CT-5341 has no process data. The IO data of the DP bus, the diagnostic data of the DP master, and the diagnostic data of the DP slave are stored on sub-slots 1-63 (submodules) of the CT-5341.

5.2 Submodule Process Data Mapping

The CT-5341 contains a total of 6 module types, which are defined as follows:

5.2.1 Diag. Master

This type of submodule reads the diagnostic data of the DP master status, and the number of configurable submodules is 0-1, and the process data accounts for 1 Double Word (Unsigned 32), which is defined as follows:

Input data								
Byte No	Bit 7	Bit 6	Bit 5	Bit 4	Bit 3	Bit 2	Bit 1	Bit 0
Byte 0	Slave Diag. Len. Err.	Master Diag. Module Num. Err.	Len. Err.	Master Err.	Master State Machine			
Byte 1	Reserved				IO Module Num. Err.	IO Output Len. Err.	IO Input Len. Err.	Slave Diag. Module Num. Err.
Byte 2	Reserved							
Byte 3	Reserved							

Data Description:

Master State Machine: The master state machine of the DP station

- 0x00: DP master offline mode
- 0x01: DP master online mode
- 0x02: The initial mode of the DP master
- 0x03: DP master test mode

Master Err.: indicates an error condition for the DP master

0: Normal

1: Faulty

Len. Err.: Error condition for the number of submodules or the length of the process data

0: Correct

1: Overrun (determined by submodule type)

Master Diag. Module Num. Err.: The DP master diagnoses the errors in the number of submodules

0: Correct

1: Overrun (maximum 1)

Slave Diag. Len. Err.: DP Slave Diagnostics Process Data Total Length Error Condition

0: Correct

1: Overrun (maximum 125 Word)

Slave Diag. Module Num. Err.: DP Slave diagnoses the number errors of sub-modules

0: Correct

1: Overrun (maximum 5 pcs)

IO Input Len. Err.: The error status of the DP bus IO input data total length

0: Correct

1: Overrun (maximum 1400 bytes)

IO Output Len. Err.: The error status of the IO output data on the DP bus total length

0: Correct

1: Overrun (maximum 1400 bytes)

IO Module Num. Err. Error status of DP bus IO data reading and writing sub-module number

0: Correct

1: Overrun (maximum 50)

5.2.2 Diag. xxx Slave(s)

This type of submodule can read the diagnostic data of DP slaves that have participated in bus configuration, and supports 1-125 DP slaves for optional. The process data of each submodule occupies n (n = xxx) Word (Unsigned 16), and each Word corresponds to 1 DP slave, which is defined as follows.

Note:

1. The number of configurable sub-modules is 0-5, and the total length of process data supports up to 125 Word after all sub-modules are added;
2. CN-8033 only supports 1-32 DP slaves for optional.

Input data										
Word No.	Bit No	Bit 7	Bit 6	Bit 5	Bit 4	Bit 3	Bit 2	Bit 1	Bit 0	
Word 0	Byte 0	Reserved				IO Data Exchange	Config Err.	Prm. Err.	Slave Mode	
	Byte 0	Slave ID								
...	...									
Word n	Byte 2n	Slave Status	Reserved			IO Data Exchange	Config Err.	Prm. Err.	Slave Mode	
	Byte 2n+1	Slave ID								

Data Description:

Slave Mode: DP slave online/offline

0: Offline

1: Online

PRM. Err.: DP slave parameter settings

0: The parameter is correct

1: The parameter is incorrect

Config Err.: the configuration status of the DP slave

- 0: The configuration is correct
- 1: The configuration is incorrect

IO Data Exchange: the I/O data exchange of the DP slaves

- 0: I/O data is not exchanged
- 1: I/O data is being exchanged

Slave ID: the ID number of the DP slave participating in the bus configuration

5.2.3 Input xxx Byte(s)

This type of submodule can read the I/O data of the DP bus, and supports 1-8 bytes for optional. The process data of each submodule occupies n (n = xxx) bytes (Unsigned 8), which is defined as follows:

Note:

The number of configurable IO data submodules (Input xxx Byte(s)/Input xxx Word(s)/Output xxx Byte(s)/Output xxx Word(s)) is 0-50, and the total length of process data is up to 1400 bytes after all IO input data submodules (Input xxx Byte(s)/Input xxx Word(s)) are added.

Output data								
Bit No	Bit 7	Bit 6	Bit 5	Bit 4	Bit 3	Bit 2	Bit 1	Bit 0
Byte 0	IO Data							
...	...							
Byte n	IO Data							

Data Description:

N/A

5.2.4 Input xxx Word(s)

This type of submodule can read the IO data of the DP bus, and supports 1-256 Word for optional. The process data of each submodule occupies n (n = xxx) Word

(Unsigned 16), which is defined as follows:

Note:

1. The number of configurable IO data submodules (Input xxx Byte(s)/Input xxx Word(s)/Output xxx Byte(s)/Output xxx Word(s)) is 0-50, and the total length of process data supports up to 1400 bytes after all IO input data submodules (Input xxx Byte(s)/Input xxx Word(s)) are added.

2. CN-8033 only supports 1-32 Word for optional.

Input data									
Word No.	Byte No	Bit 7	Bit 6	Bit 5	Bit 4	Bit 3	Bit 2	Bit 1	Bit 0
Word 0	Byte 0	IO Data							
	Byte 1								
...							
Word n	Byte 2n	IO Data							
	Byte 2n+1								

Data Description:

N/A

5.2.5 Output xxx Byte(s)

This type of submodule can write I/O data to the DP bus, and supports 1-8 bytes for optional. The process data of each submodule occupies n (n = xxx) bytes (Unsigned 8), which is defined as follows:

Note:

The number of configurable IO data submodules (Input xxx Byte(s)/Input xxx Word(s)/Output xxx Byte(s)/Output xxx Word(s)) is 0-50, and the total length of process data supports up to 1400 bytes after all IO output data submodules (Output xxx Byte(s)/Output xxx Word(s)) are added.

Output data								
Byte No	Bit 7	Bit 6	Bit 5	Bit 4	Bit 3	Bit 2	Bit 1	Bit 0
Byte 0	IO Data							
...	...							
Byte n	IO Data							

Data Description:

N/A

5.2.6 Output xxx Word(s)

This type of submodule can write I/O data to the DP bus, and supports 1-256 Word for optional. The process data of each submodule occupies n (n = xxx) bytes (Unsigned 16), which is defined as follows:

Note:

1. The number of configurable IO data submodules (Input xxx Byte(s)/Input xxx Word(s)/Output xxx Byte(s)/Output xxx Word(s)) is 0-50, and the total length of process data supports up to 1400 bytes after all IO output data submodules (Output xxx Byte(s)/Output xxx Word(s)) are added.
2. CN-8033 only supports 1-32 Word for optional.

Input data									
Word No.	Byte No	Bit 7	Bit 6	Bit 5	Bit 4	Bit 3	Bit 2	Bit 1	Bit 0
Word 0	Byte 0	IO Data							
	Byte 1								
...							
Word n	Byte 2n	IO Data							
	Byte 2n+1								

Data Description:

N/A

6 Configuration Parameters Definition

CT-5341 sub-slot 0 has configuration parameters.

CT-5341 sub-slots 1-63 (sub-module) have no configuration parameters (each sub-module reserves 1 byte of configuration parameters for future expansion).

The configuration parameters of CT-5341 sub-slot 0 include input and output fault handling configuration parameters, which account for 5 bytes in length and are defined as follows:

Configure parameters									
Byte No	Bit 7	Bit 6	Bit 5	Bit 4	Bit 3	Bit 2	Bit 1	Bit 0	
Byte 0	Reserved					Byte Swap	Fault Action Out	Fault Action In	
Byte 1	Reserved								
Byte 2									
Byte 3									
Byte 4									

Data Description:

Fault Action In: Enter the fault handling method. In the event of a disconnection from communication with the lower layer (DP slave) or failure of the DP master, the CT-5341 processes the IO input data of the DP bus in this mode. (Default: 1)

0: Keeps the last input value

1: Zeroing the input value

Fault Action Out: Outputs the fault handling method. When disconnected from the upper layer communication (C-series coupler, such as CN-8031, etc.), the CT-5341 processes the IO output data of the DP bus in this mode. (Default: 1).

0: Keeps the last output value

1: Zeroing the output value

Byte Swap: Input xxx Word(s)/Output xxx Word(s) submodule process data endian swap. (Default: 0)

0: Forbidden

1: Enable

A Dimensional drawing

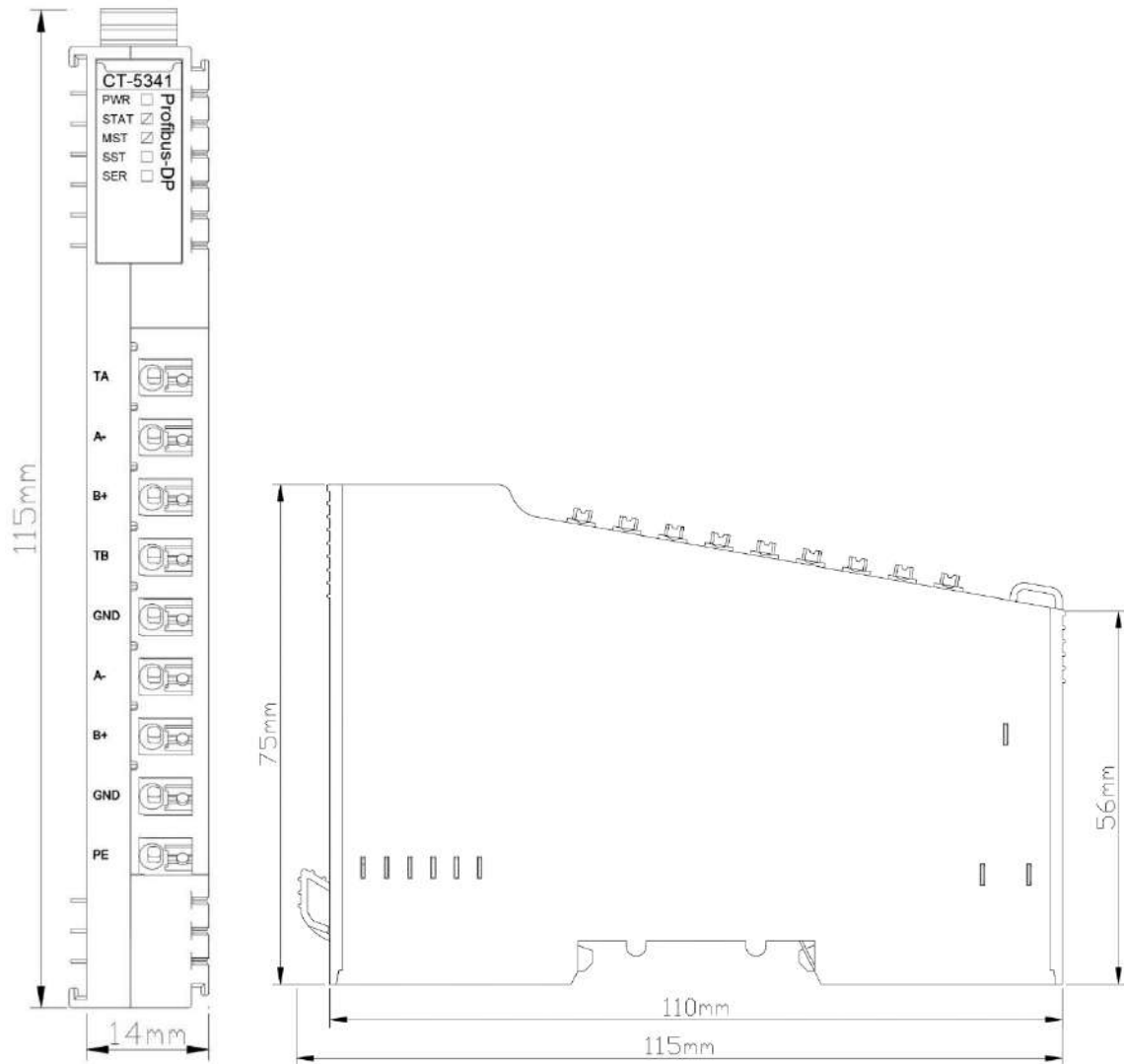

CT-5711 Bus extended master module

1 Module Description

The bus extended master module is used to extend the bus. The bus extended master module has no process data and configuration parameters.

2 Technical Parameters

General Parameters	
Power	Max.20mA@5.0Vdc
Mounting Type	35mmDIN-Rail
Size	115*14*75mm
Weight	65g
Environment Specification	
Operating Temperature of Horizontal Installation	-35°C~70°C
Operating Temperature of Vertical Installation	-35°C~60°C
Relative Humidity	< 95%RH (No Condensation)
Storage Temperature	-40°C~85°C
Storage Humidity	< 95%RH (No Condensation)
Manufacturing Test Temperature	-40°C~75°C
Ingress Protection Rating	IP20
Bus parameter	
Bus Extension Spacing	No more than 8 meters
Number of Expansion Stations	No more than 5 stations

WARNING

UNEXPECTED EQUIPMENT OPERATION

Do not exceed any of the ratings specified in the environmental and electrical characteristics table.

Failure to follow instructions specified by the manufacturer may result in serious consequences such as death, personal injury, or damage to equipment since the protection provided by the equipment may be impaired.

AVERTISSEMENT

FONCTIONNEMENT INATTENDU DE L'EQUIPEMENT

Ne dépassez aucune évaluation spécifiée dans le tableau de caractéristiques environnementales

et électriques..

Le fait de ne pas suivre les instructions peut entraîner une défaillance de la protection fournie par l'équipement, ce qui peut entraîner des conséquences graves, comme des blessures ou des dommages à l'équipement.

3 Hardware Interface

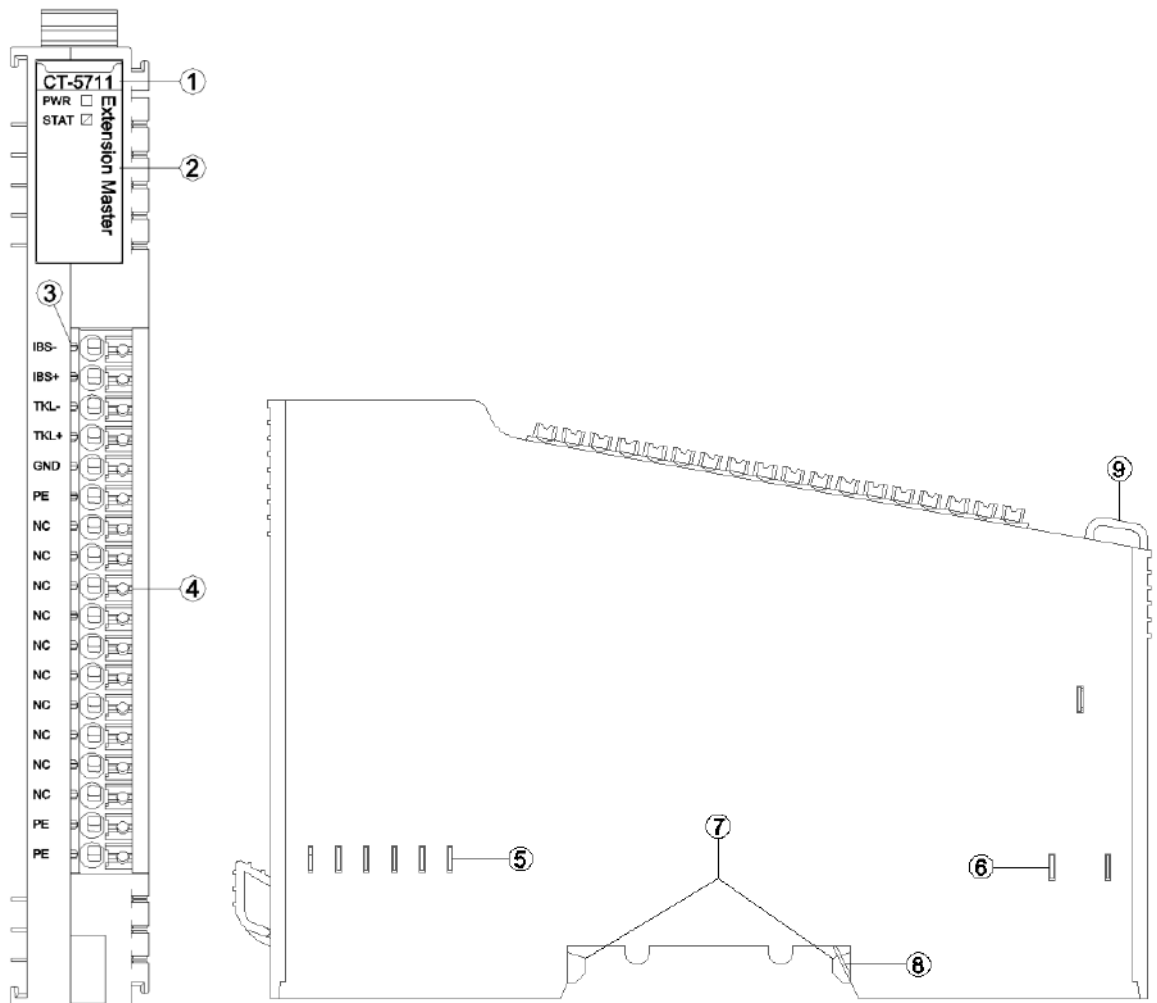

- ① Module Type
- ② State indicator
- ③ Channel indicator (N/A)
- ④ Wiring Terminal and identification
- ⑤ Internal Bus
- ⑥ Field Power (N/A)
- ⑦ Buckle
- ⑧ Grounding Spring Sheet
- ⑨ Fixed Wiring Harness

3.1 LED indicator definition

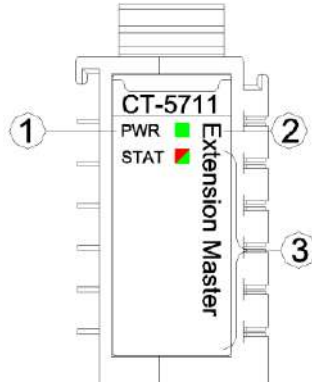

① System Power LED indicator (red)

② Bus State LED indicator (red/green)

PWR POWER STATE (RED)	Definition
ON	System Power Normal
OFF	System Power Failure
STAT Bus STATE (RED/GREEN)	Definition
Green slow flash (2.5Hz)	Module internal bus is not started
Red slow flash (2.5Hz)	Module internal bus offline
ON (GREEN)	Operation normal
Flash(2.5Hz) (RED/GREEN)	Upgrading mode
Flash(10Hz) (RED/GREEN)	Firmware Update
Double Flash (RED)	Module Exception, has been soft-restarted

!WARNING

UNEXPECTED EQUIPMENT OPERATION

By viewing the PW indicator, could determine the power supply status of a module. If the PW is steady green, the power supply is normal. Otherwise, the module cannot work properly.

When the module is initially powered on, there will be 3S for the backplane bus connection. After the backplane bus is initialized, STA is in the green steady state. If STA is in the green blinking state, it indicates that the backplane bus has not been initialized, and it needs to be powered off and restarted for re-initialization.

STA abnormal working state occurs during the normal operation of the module, please check the firmware version information of all modules, and consult ODOT technical support for details.

If a module is upgraded, check that all modules are in the normal state after the upgrade. Otherwise, an exception may occur.

Failure to follow instructions specified by the manufacturer may result in serious consequences such as death, personal injury, or damage to equipment since the protection provided by the equipment may be impaired.

AVERTISSEMENT

FONCTIONNEMENT INATTENDU DE L'EQUIPEMENT

En regardant l'état de l'indicateur de PW, jugez l'état d'alimentation du module. Le feu vert PW reste allumé et l'alimentation est normale. Autrement, le module ne fonctionnera pas correctement.

Lorsque le module est alimenté initialement, il y aura 3S pour la connexion de bus de backboard. STA est un état vert permanent après l'initialisation du bus de backboard. Si STA est en état de clignotement vert, cela signifie que l'initialisation du bus de backboard n'est pas passée et doit être redémarrée hors tension et réinitialisée.

L'état de fonctionnement anormal de STA se produit pendant le fonctionnement normal du module, veuillez vérifier les informations de version du firmware de tous les modules, et consulter le support technique ODOT pour plus de détails.

Si le module a une opération de mise à niveau, après l'achèvement de la mise à niveau, le besoin de vérifier que tous les modules sont dans l'état normal avant de courir, sinon il conduira à une exception.

Le fait de ne pas suivre les instructions peut entraîner une défaillance de la protection fournie par l'équipement, ce qui peut entraîner des conséquences graves, comme des blessures ou des dommages à l'équipement.

4 Bus extension topology diagram

The backplane bus extension length spacing is not more than 8 meters, the IO module expansion data is less than 32, and a terminal module CT-5801 must be equipped.

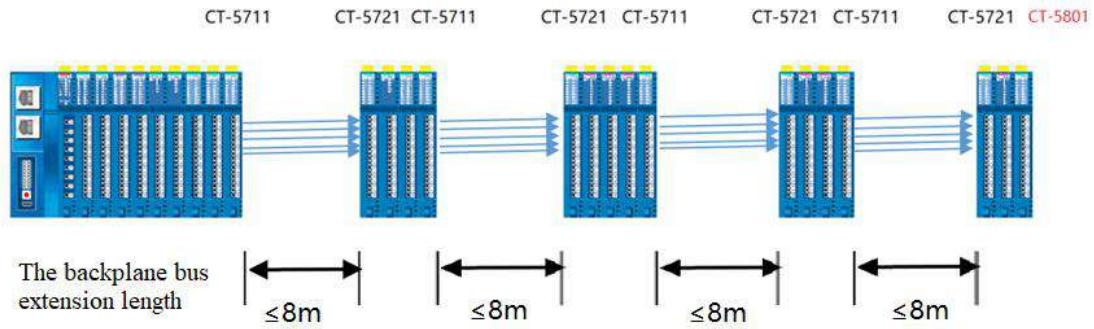

I/O modules is less than 32

5 Wiring

Bus extended cable requires 5 core shielded cable, IBS+ and IBS- must use twisted pair. PE guarantees a reliable grounding and the total length of the bus extended cable should not exceed 10 meters.

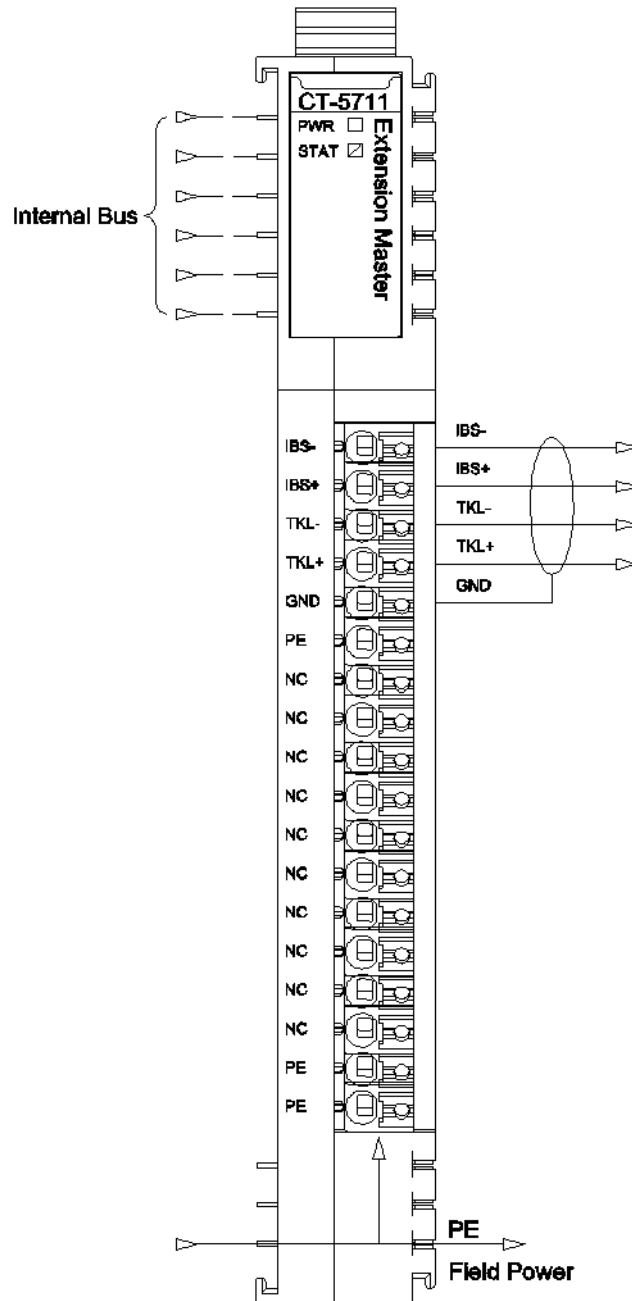

NOTICE

EQUIPMENT INOPERABLE

Do not crimp the spring terminal with more than the maximum pressure specified for the terminal. Otherwise, the resilience of the spring terminal may be damaged and the terminal rebound may

be affected.

Do not press the spring terminal with a sharp tool when removing cable from the channel.

Otherwise, the spring terminal will be damaged.

Failure to follow these instructions may result in equipment damage.

A Dimension drawing

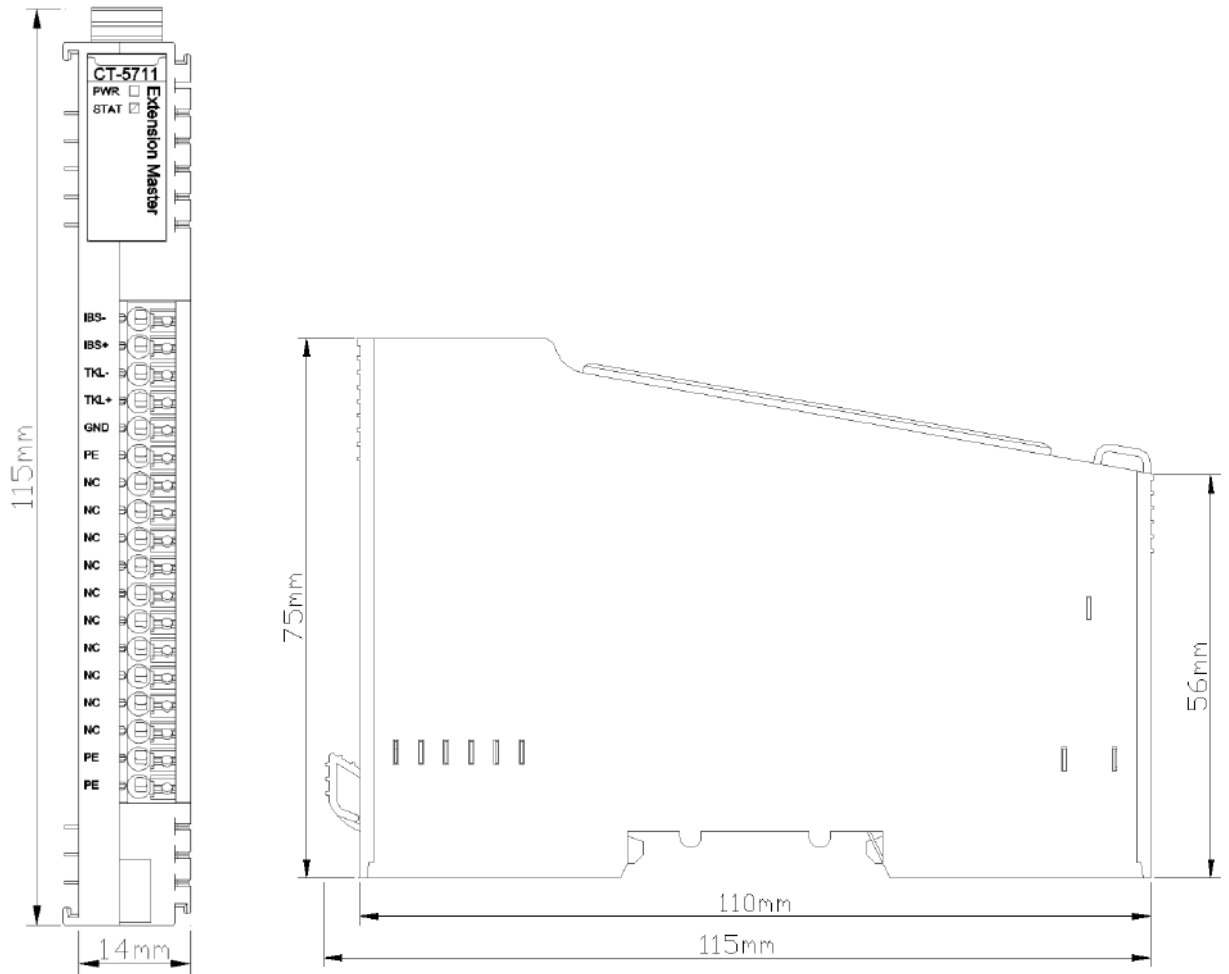

CT-5721 Bus extended slave module

1 Module Description

The bus extended slave module is used to extend the bus. The bus extended slave module has no process data and configuration parameters.

2 Technical Parameters

General Parameters	
Power	Max.20mA@5.0Vdc
Mounting Type	35mmDIN-Rail
Size	115*14*75mm
Weight	65g
System Power	Nominal: 24Vdc, Range: 20-30Vdc Current:Max.2A@24VDC Protection: Overcurrent Protection, Reverse Protection: YES
Internal BUS Supply Current	Max. 2.5A@5VDC
Isolation	System Power to Field Power Isolation
Field Power Supply	Power Supply: 20.4~28.8V (Nominal 24VDC) Protection: Reverse Protection: YES
Field Power Supply Current	Max. DC 8A
Environment Specification	
Operating Temperature of Horizontal Installation	-35°C~70°C
Operating Temperature of Vertical Installation	-35°C~60°C
Relative Humidity	< 95%RH (No Condensation)
Storage Temperature	-40°C~85°C
Storage Humidity	< 95%RH (No Condensation)
Manufacturing Test Temperature	-40°C~75°C
Ingress Protection Rating	IP20
Bus parameter	
Bus Extension Spacing	No more than 8 meters
Number of Expansion Stations	No more than 5 stations

WARNING

UNEXPECTED EQUIPMENT OPERATION

Do not exceed any of the ratings specified in the environmental and electrical characteristics

table.

Failure to follow instructions specified by the manufacturer may result in serious consequences such as death, personal injury, or damage to equipment since the protection provided by the equipment may be impaired.

 **AVERTISSEMENT**

FONCTIONNEMENT INATTENDU DE L'EQUIPEMENT

Ne dépassez aucune évaluation spécifiée dans le tableau de caractéristiques environnementales et électriques..

Le fait de ne pas suivre les instructions peut entraîner une défaillance de la protection fournie par l'équipement, ce qui peut entraîner des conséquences graves, comme des blessures ou des dommages à l'équipement.

3 Hardware Interface

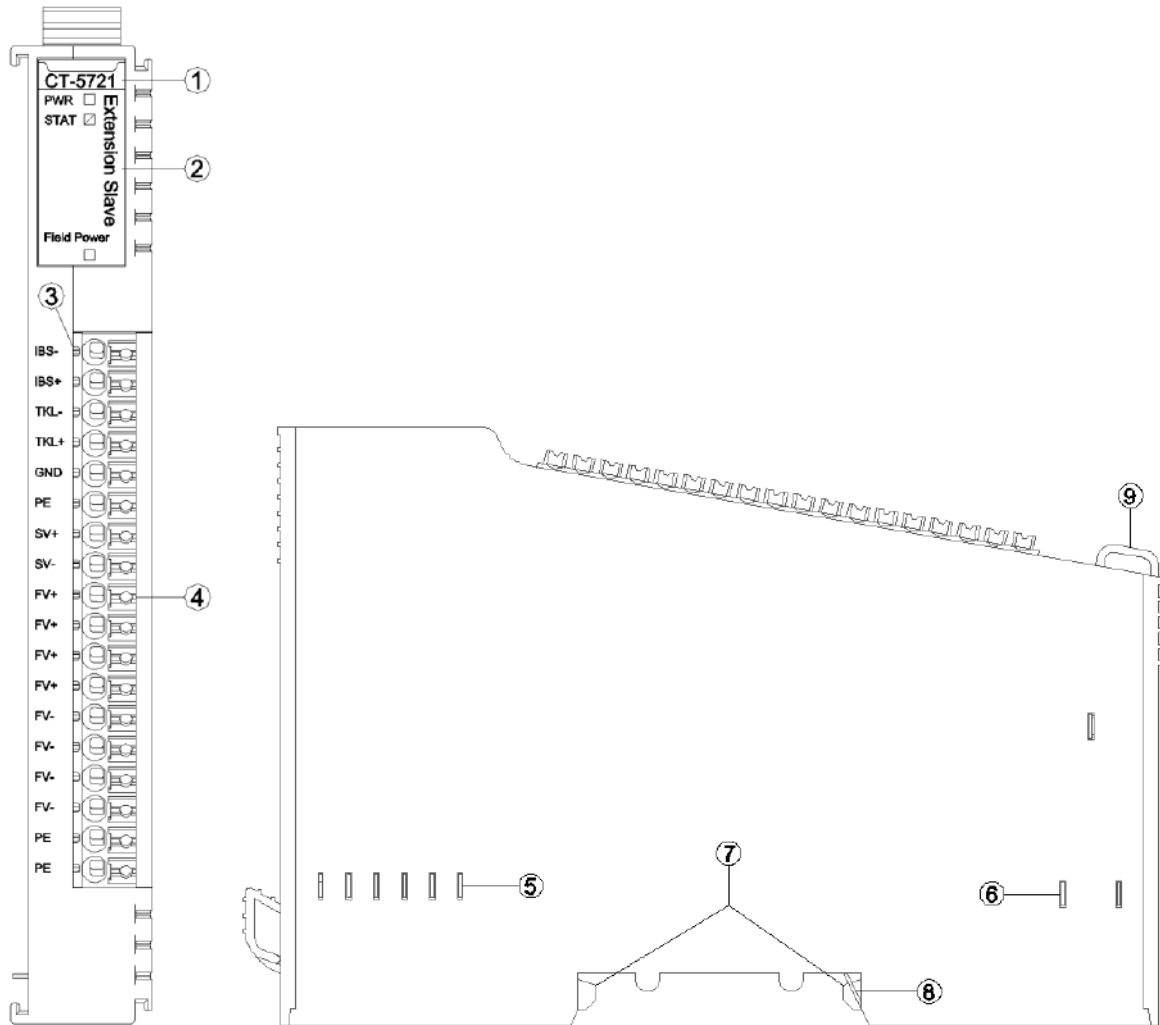

- ① Module Type
- ② State indicator
- ③ Channel indicator (N/A)
- ④ Wiring Terminal and identification
- ⑤ Internal Bus
- ⑥ Field Power
- ⑦ Buckle
- ⑧ Grounding Spring Sheet
- ⑨ Fixed Wiring Harness

3.1 LED indicator definition

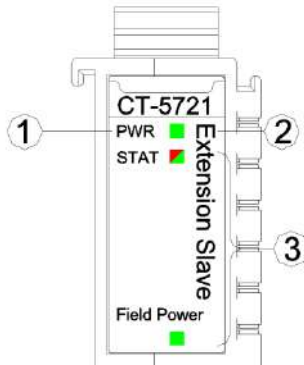

① System Power LED indicator (red)

② Bus State LED indicator (red/green)

PWR POWER STATE (RED)	Definition
ON	System Power Normal
OFF	System Power Failure
STAT Bus STATE (RED/GREEN)	Definition
Green slow flash (2.5Hz)	Module internal bus is not started
Red slow flash (2.5Hz)	Module internal bus offline
ON (GREEN)	Operation normal
Flash(2.5Hz) (RED/GREEN)	Upgrading mode
Flash(10Hz) (RED/GREEN)	Firmware Update
Double Flash (RED)	Module Exception, has been soft-restarted

!WARNING

UNEXPECTED EQUIPMENT OPERATION

By viewing the PW indicator, could determine the power supply status of a module. If the PW is steady green, the power supply is normal. Otherwise, the module cannot work properly.

When the module is initially powered on, there will be 3S for the backplane bus connection. After the backplane bus is initialized, STA is in the green steady state. If STA is in the green blinking state, it indicates that the backplane bus has not been initialized, and it needs to be powered off and restarted for re-initialization.

STA abnormal working state occurs during the normal operation of the module, please check the firmware version information of all modules, and consult ODOT technical support for details.

If a module is upgraded, check that all modules are in the normal state after the upgrade. Otherwise, an exception may occur.

Failure to follow instructions specified by the manufacturer may result in serious consequences such as death, personal injury, or damage to equipment since the protection provided by the equipment may be impaired.

AVERTISSEMENT

FONCTIONNEMENT INATTENDU DE L'EQUIPEMENT

En regardant l'état de l'indicateur de PW, jugez l'état d'alimentation du module. Le feu vert PW reste allumé et l'alimentation est normale. Autrement, le module ne fonctionnera pas correctement.

Lorsque le module est alimenté initialement, il y aura 3S pour la connexion de bus de backboard. STA est un état vert permanent après l'initialisation du bus de backboard. Si STA est en état de clignotement vert, cela signifie que l'initialisation du bus de backboard n'est pas passée et doit être redémarrée hors tension et réinitialisée.

L'état de fonctionnement anormal de STA se produit pendant le fonctionnement normal du module, veuillez vérifier les informations de version du firmware de tous les modules, et consulter le support technique ODOT pour plus de détails.

Si le module a une opération de mise à niveau, après l'achèvement de la mise à niveau, le besoin de vérifier que tous les modules sont dans l'état normal avant de courir, sinon il conduira à une exception.

Le fait de ne pas suivre les instructions peut entraîner une défaillance de la protection fournie par l'équipement, ce qui peut entraîner des conséquences graves, comme des blessures ou des dommages à l'équipement.

4 Topological graph

The backplane bus expansion length spacing is not more than 8 meters, the IO module expansion data is less than 32, and a terminal module CT-5801 must be equipped.

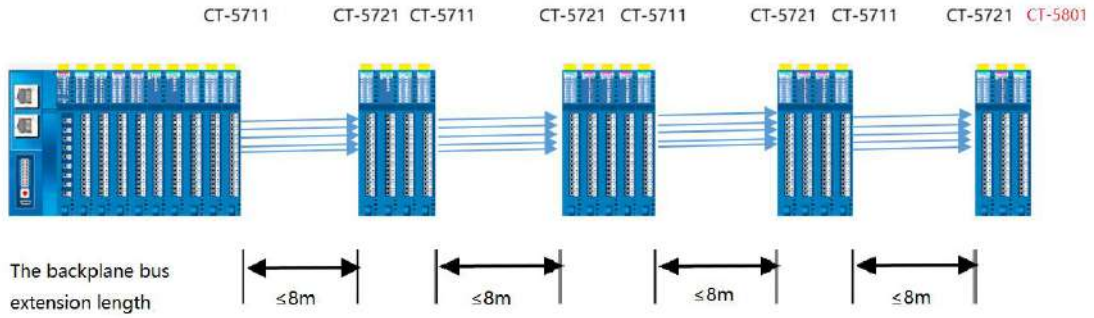

The number of expanded I/O modules is less than 32

5 Wiring

Bus extended cable requires 5 core shielded cable, IBS+ and IBS- must use twisted pair. PE guarantees a reliable grounding and the total length of the bus extended cable should not exceed 10 meters.

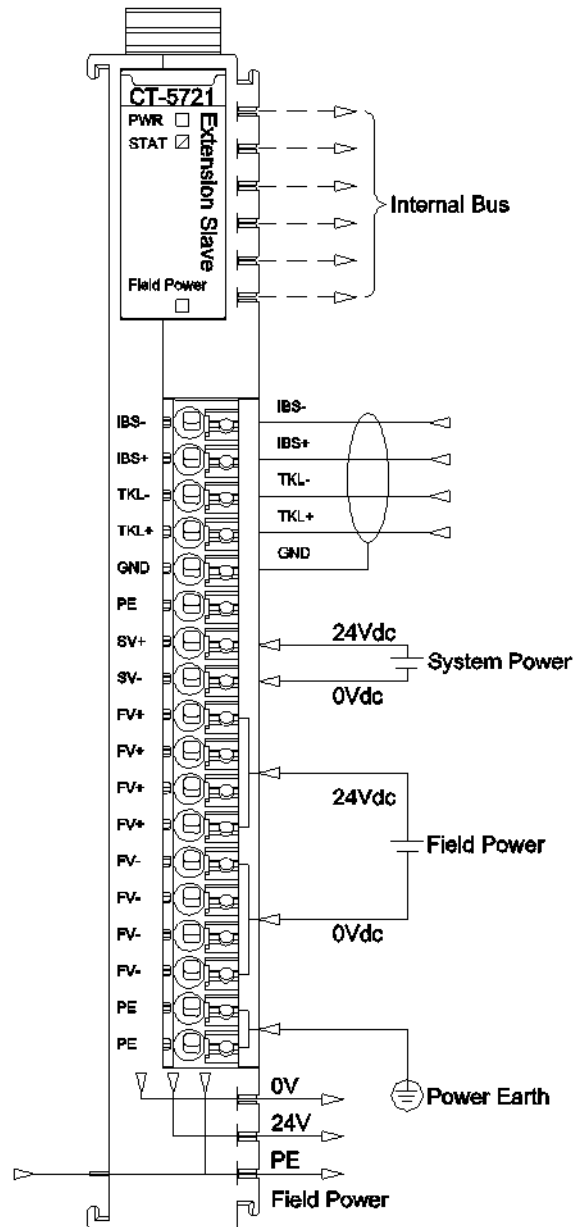

NOTICE

EQUIPMENT INOPERABLE

Do not crimp the spring terminal with more than the maximum pressure specified for the terminal. Otherwise, the resilience of the spring terminal may be damaged and the terminal rebound may be affected.

Do not press the spring terminal with a sharp tool when removing cable from the channel.
Otherwise, the spring terminal will be damaged.

Failure to follow these instructions may result in equipment damage.

A Dimension drawing

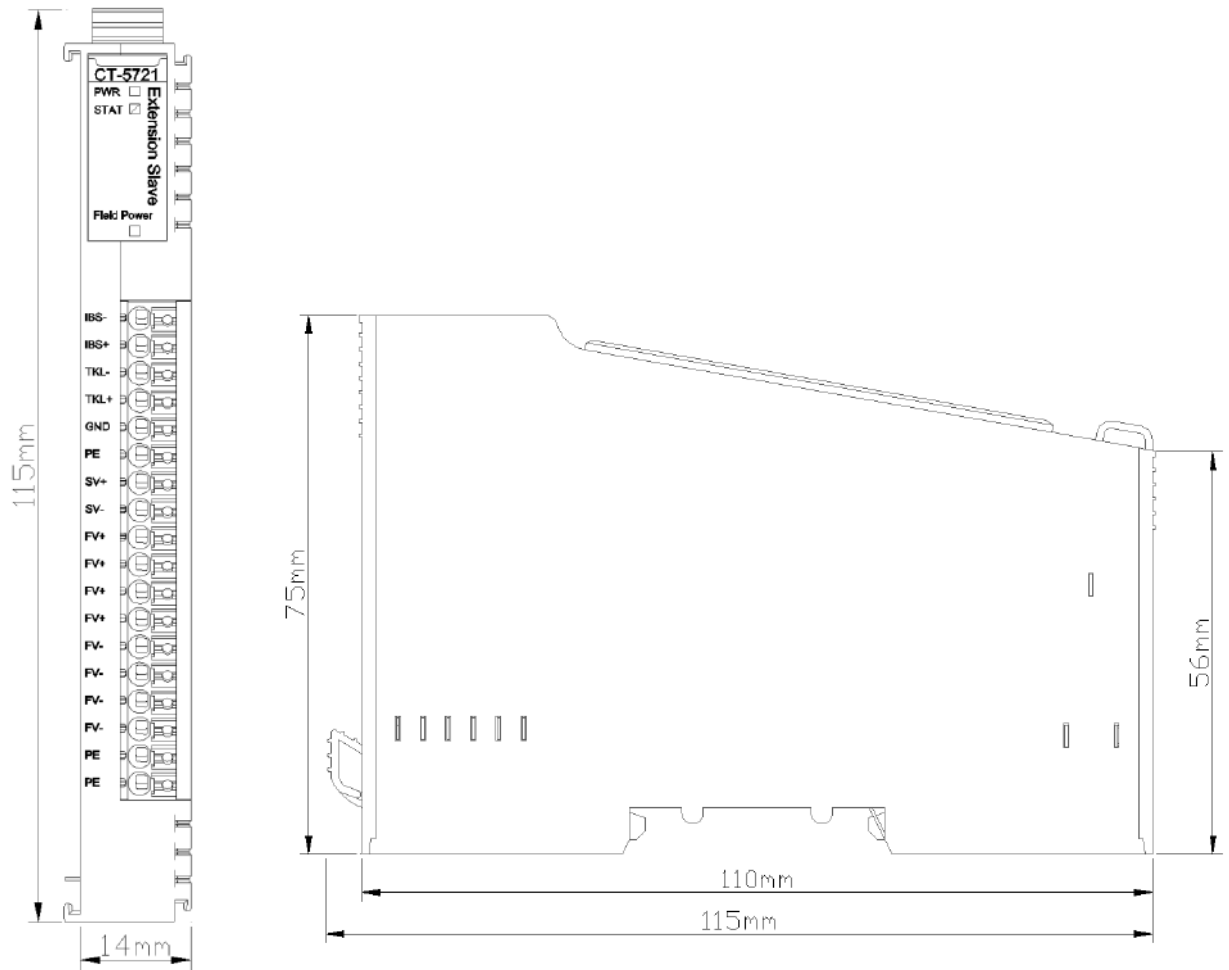

CT-5800 Terminal module

1 Module Description

The terminal module is used to stabilize the internal bus communication. The terminal module has no process data and configuration parameters.

CT-5800 requires configuration and occupies slots.

2 Technical Parameters

General Parameters	
Power	Max.20mA@5.0Vdc
Mounting Type	35mmDIN-Rail
Size	115*14*75mm
Weight	65g
Environment Specification	
Operating Temperature of Horizontal Installation	-35°C~70°C
Operating Temperature of Vertical Installation	-35°C~60°C
Relative Humidity	< 95%RH (No Condensation)
Storage Temperature	-40°C~85°C
Storage Humidity	< 95%RH (No Condensation)
Manufacturing Test Temperature	-40°C~75°C
Ingress Protection Rating	IP20

WARNING

UNEXPECTED EQUIPMENT OPERATION

Do not exceed any of the ratings specified in the environmental and electrical characteristics table.

Failure to follow instructions specified by the manufacturer may result in serious consequences such as death, personal injury, or damage to equipment since the protection provided by the equipment may be impaired.

AVERTISSEMENT

FONCTIONNEMENT INATTENDU DE L'EQUIPEMENT

Ne dépassez aucune évaluation spécifiée dans le tableau de caractéristiques environnementales

et électriques..

Le fait de ne pas suivre les instructions peut entraîner une défaillance de la protection fournie par l'équipement, ce qui peut entraîner des conséquences graves, comme des blessures ou des dommages à l'équipement.

3 Hardware Interface

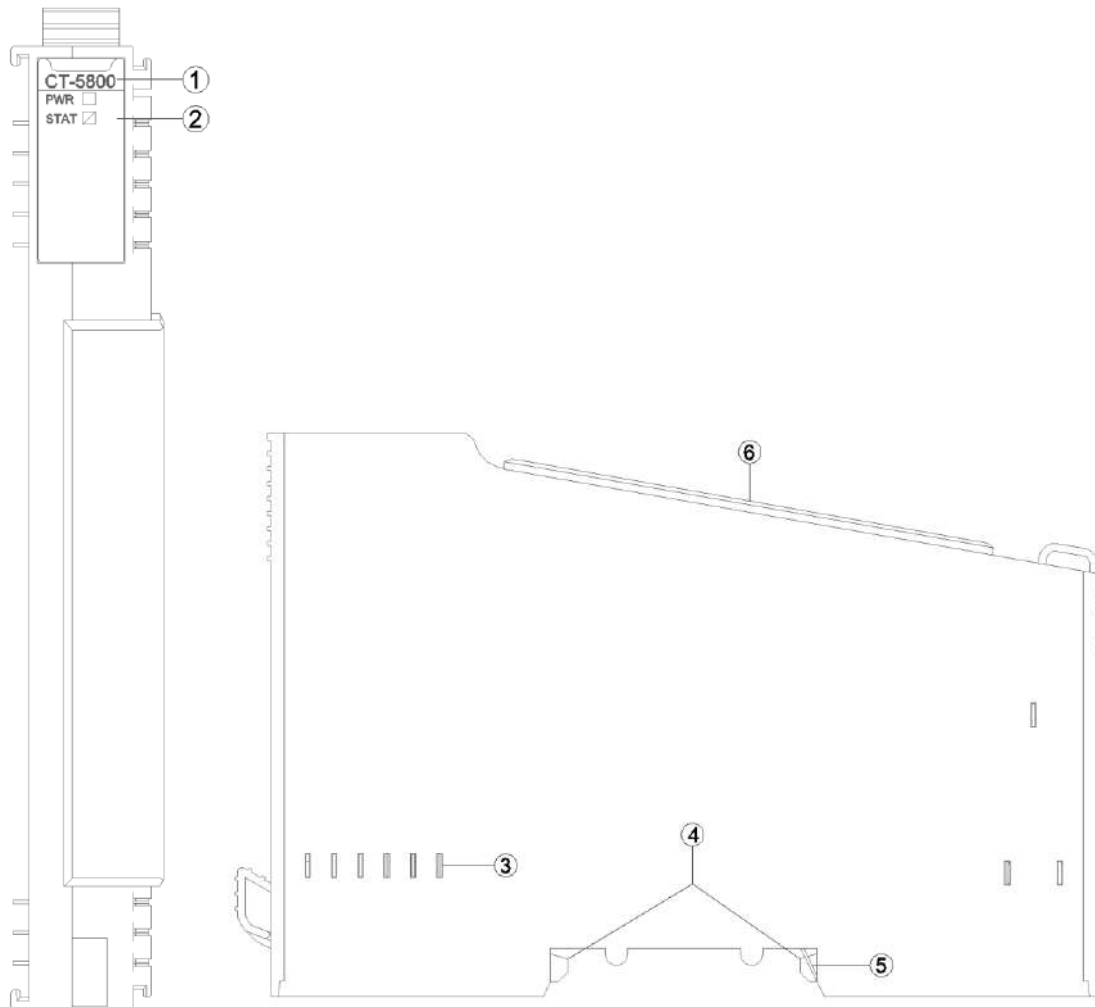

- ① Module Type
- ② State indicator
- ③ Internal Bus
- ④ Buckle
- ⑤ Grounding Spring Sheet
- ⑥ Terminal Cover

3.1 LED indicator definition

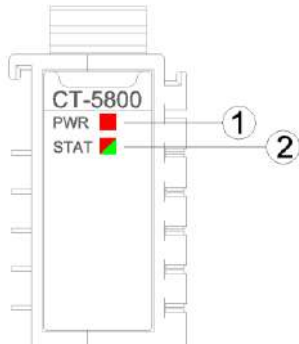

- ① System Power LED indicator(red)
- ② Module State LED indicator (red/green)

PWR Power LED Indicator (Red)	Definition
ON	The system power supply is normal.
OFF	The system power supply is failure
STAT Module State LED Indicator (Red/Green)	Definition
Green slow flash (2.5Hz)	Module internal bus is not started
Red slow flash (2.5Hz)	Module internal bus offline
ON (GREEN)	Operation normal
Flash(2.5Hz) (RED/GREEN)	Upgrading mode
Flash(10Hz) (RED/GREEN)	Firmware Update
Double Flash (RED)	Module Exception has been soft-restarted

! WARNING

UNEXPECTED EQUIPMENT OPERATION

By viewing the PW indicator, could determine the power supply status of a module. If the PW is steady green, the power supply is normal. Otherwise, the module cannot work properly.

When the module is initially powered on, there will be 3S for the backplane bus connection. After the backplane bus is initialized, STA is in the green steady state. If STA is in the green blinking state, it indicates that the backplane bus has not been initialized, and it needs to be powered off and restarted for re-initialization.

STA abnormal working state occurs during the normal operation of the module, please check the firmware version information of all modules, and consult ODOT technical support for details.

If a module is upgraded, check that all modules are in the normal state after the upgrade. Otherwise, an exception may occur.

Failure to follow instructions specified by the manufacturer may result in serious consequences such as death, personal injury, or damage to equipment since the protection provided by the equipment may be impaired.

AVERTISSEMENT

FONCTIONNEMENT INATTENDU DE L'EQUIPEMENT

En regardant l'état de l'indicateur de PW, jugez l'état d'alimentation du module. Le feu vert PW reste allumé et l'alimentation est normale. Autrement, le module ne fonctionnera pas correctement.

Lorsque le module est alimenté initialement, il y aura 3S pour la connexion de bus de backboard. STA est un état vert permanent après l'initialisation du bus de backboard. Si STA est en état de clignotement vert, cela signifie que l'initialisation du bus de backboard n'est pas passée et doit être redémarrée hors tension et réinitialisée.

L'état de fonctionnement anormal de STA se produit pendant le fonctionnement normal du module, veuillez vérifier les informations de version du firmware de tous les modules, et consulter le support technique ODOT pour plus de détails.

Si le module a une opération de mise à niveau, après l'achèvement de la mise à niveau, le besoin de vérifier que tous les modules sont dans l'état normal avant de courir, sinon il conduira à une exception.

Le fait de ne pas suivre les instructions peut entraîner une défaillance de la protection fournie par l'équipement, ce qui peut entraîner des conséquences graves, comme des blessures ou des dommages à l'équipement.

A Dimension drawing

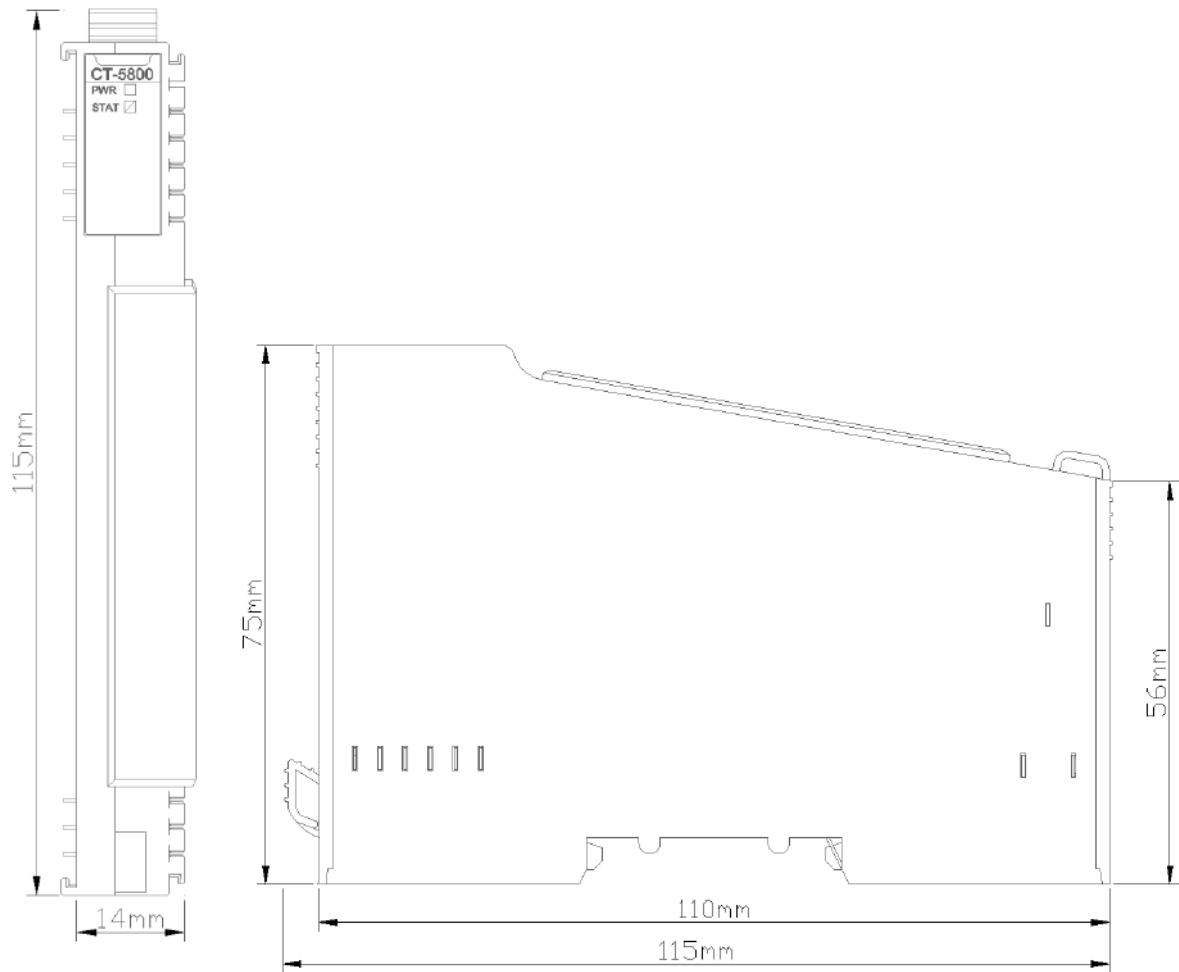

CT-5801 Terminal module (Required)

1 Module Description

The terminal module is used to stabilize internal bus communication and it is required.

The terminal module CT-5801 has no process data and no configuration parameters.

CT-5801 requires no configuration and occupies no slot in configuration.

2 Technical Parameters

N/A

3 Hardware Interface

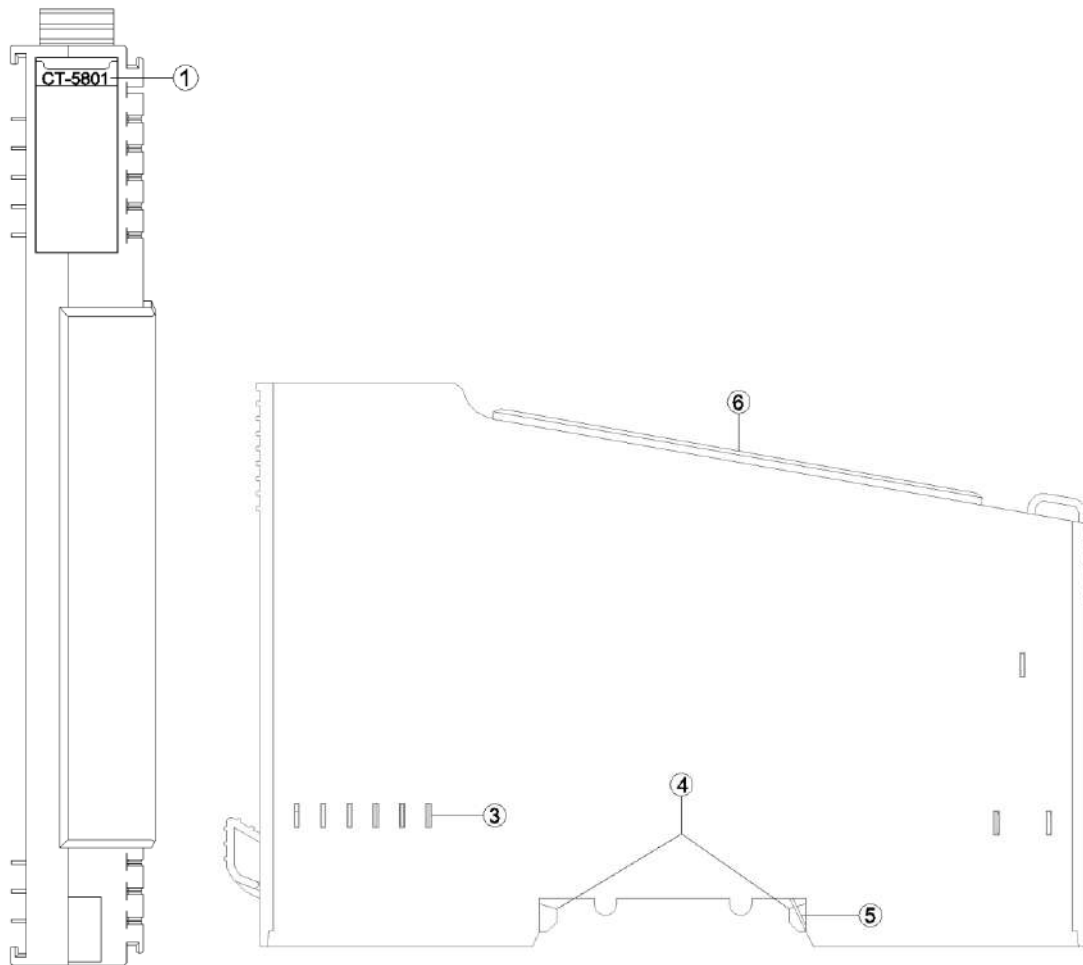

- ① Module Type
- ③ Internal Bus
- ④ Buckle
- ⑤ Grounding Spring Sheet
- ⑥ Terminal Cover

3.1 LED indicator definition

N/A

A Dimension drawing

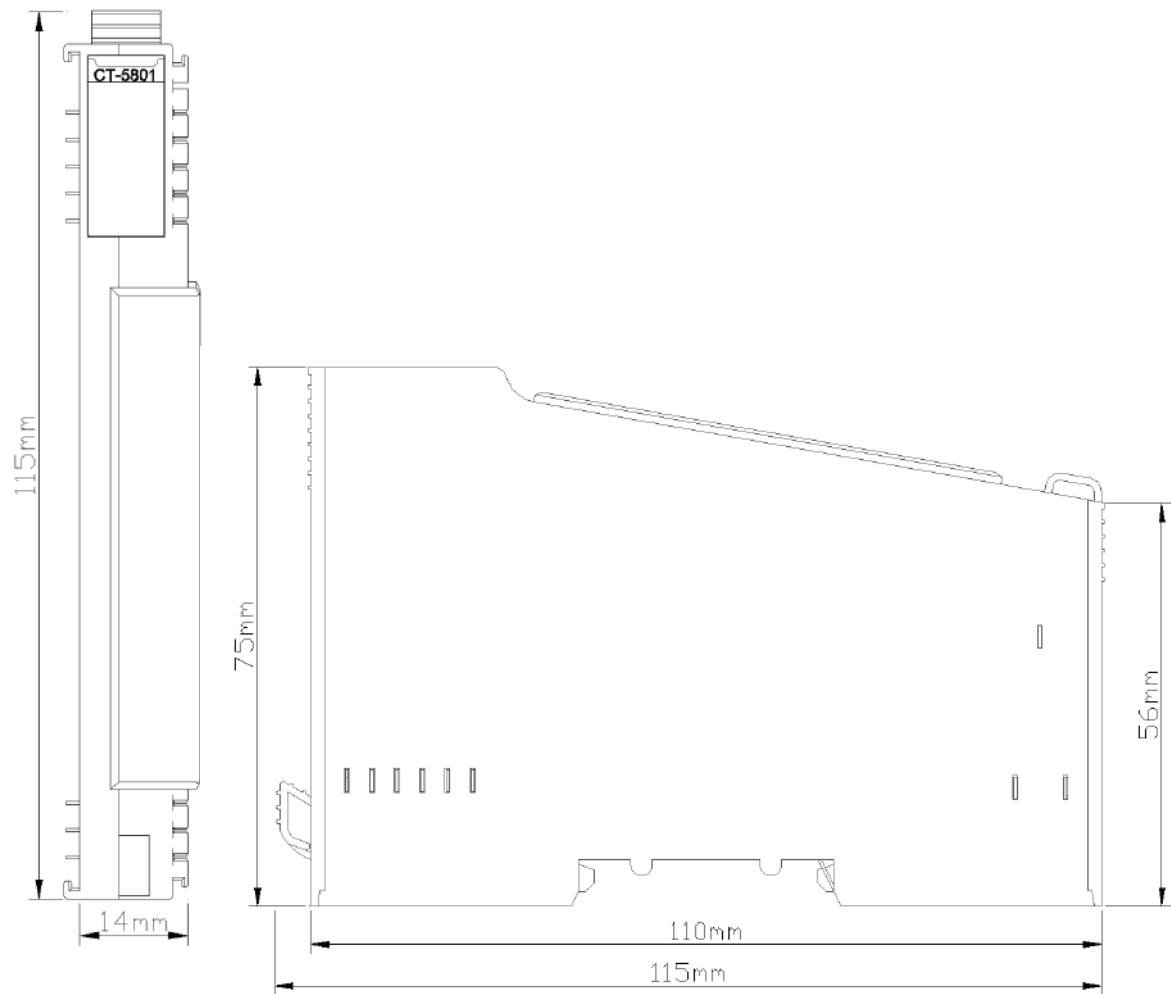

CT-5802 Terminal module (Required)

1 Module Description

The terminal module is used to stabilize internal bus communication and it is required.

The terminal module CT-5801 has no process data and no configuration parameters.

CT-5801 requires no configuration and occupies no slot in configuration.

2 Technical Parameters

N/A

3 Hardware Interface

N/A

A Dimension drawing

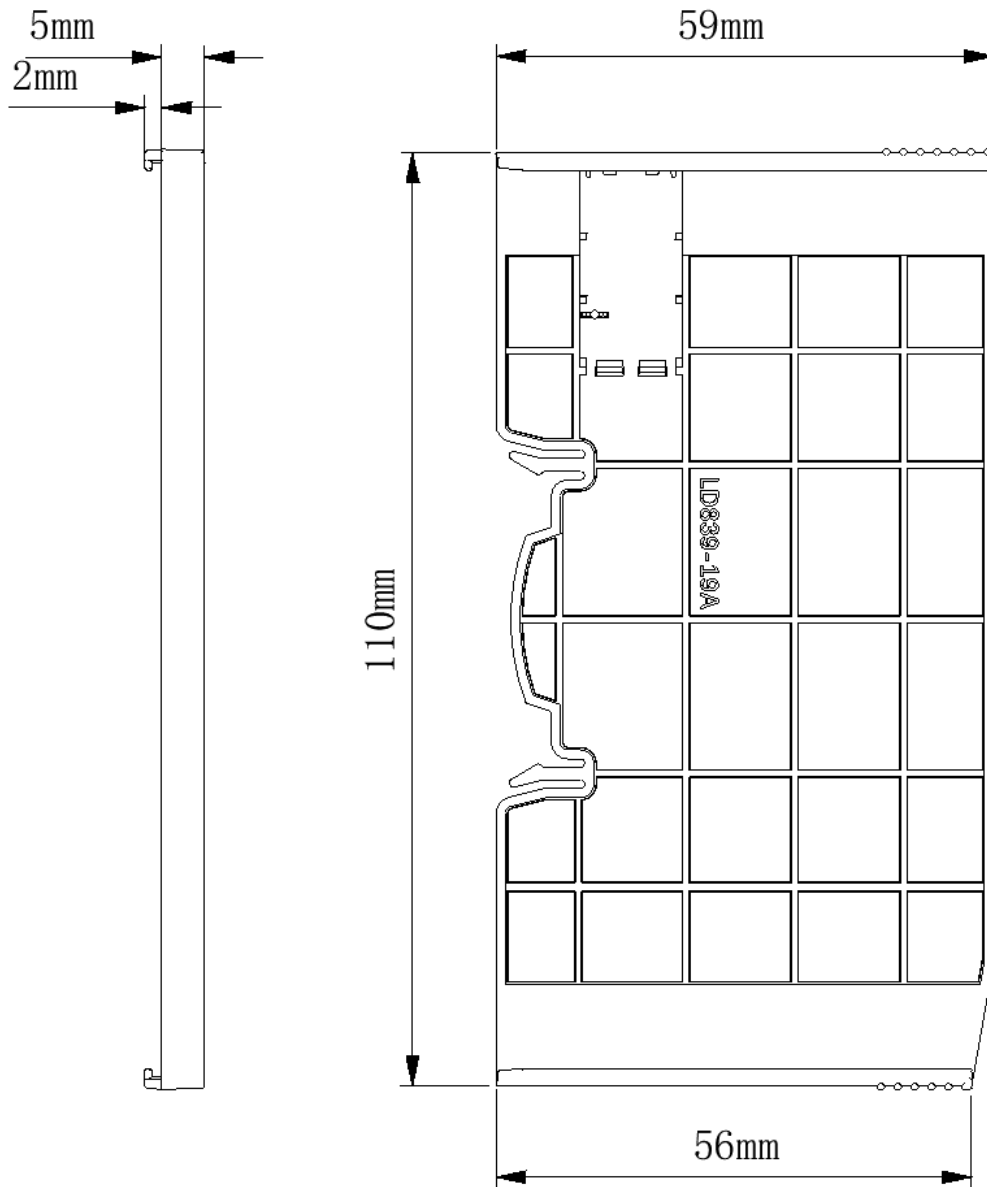

CT-623F 8-channels DI /24VDC/ source or sink type & 8-channels DO /24VDC/ source type

1 Module features

- ◆ The module supports 8-channel digital input, and supports source type and sink type two-way input. The input voltage is 0V/24VDC.
- ◆ The module supports 8-channel digital output, Output high level valid, and the output voltage is 24VDC.
- ◆ Module input channel can collect digital output signal of field equipment. (dry contact or active output)
- ◆ The module input channel can be connected to the 2-wire or 3-wire digital sensor.
- ◆ Module input channel supports 32-bit counter for each channel, the counting frequency < 200Hz.
- ◆ The input channel of the module supports the signal maintenance function, and the maintenance time can be set.
- ◆ The input channel of the module can set the digital signal input filtering time and the byte transfer order of the counter.
- ◆ The input channel of the module can set the counting mode and counting direction independently.
- ◆ Module output channel can drive field equipment .(relay, solenoid valve, etc.)
- ◆ The output channel of the module is equipped with short circuit, thermal shutdown and overvoltage protection functions.
- ◆ Module internal bus and field input and output , using Optocoupler isolation.
- ◆ Module has 16 digital input and output channel LED indicator light.

2 Technical parameters

General Parameters	
Power	Max.85mA@5.0Vdc
Isolation	I/O to internal bus: opto-coupler isolation (3KVrms)
Field Power	Nominal voltage: 24Vdc Input range: 20.4~28.8Vdc
Wiring	Max.: AWG 18
Installation	35mm DIN-Rail
Size	115*14*75mm
Weight	65g
Vibration Resistance	Comply with IEC 61131-2 and EC 60068-2-6
Impact resistance	Comply with IEC 61131-2 and IEC 60068-2-27
EMC Performance	Comply with IEC 61131-2 and IEC 61000-4
Environment Specification	
Operating Temperature of Horizontal Installation	-35°C~70°C
Operating Temperature of Vertical Installation	-35°C~60°C
Relative Humidity	< 95%RH (No Condensation)
Storage Temperature	-40°C~85°C
Storage Humidity	< 95%RH (No Condensation)
Manufacturing Test Temperature	-40°C~75°C
Ingress Protection Rating	IP20
Environmental Parameters	
Channel Number	8-channel source/sink type input
Indicator	8 channel input indicators
Open Voltage	High input: Min.10Vdc to Max.28Vdc (Common: 0Vdc) Low input: Min.0Vdc to Max.14Vdc (Common: 24Vdc)
Close Voltage	High input: Max.5Vdc (Common: 0Vdc) Low input: Min.19Vdc (Common: 24Vdc)
Open Current	Max.5mA/ channel @28V
Input Impedance	>7.5kΩ
Input Delay	OFF to ON: Max.3ms ON to OFF: Max.2ms
Prop Filter	Default: 10ms
Sampling Frequency	500Hz
Count Frequency	<200Hz
Output Parameter	
Channel Number	8 channel source type output

LED Indicator	8 channel output indicators
Rated Current	Typical value:0.5A
Leakage Current	Maximum value: 10uA
Output Impedance	<200mΩ
Output Delay	OFF to ON: Max.100us ON to OFF: Max.150us
Protection Function	Temperature protection: typical value 135°C Protection current: typical value 1.1A Short circuit protection support

WARNING

UNEXPECTED EQUIPMENT OPERATION

Do not exceed any of the ratings specified in the environmental and electrical characteristics table.

Failure to follow instructions specified by the manufacturer may result in serious consequences such as death, personal injury, or damage to equipment since the protection provided by the equipment may be impaired.

AVERTISSEMENT

FONCTIONNEMENT INATTENDU DE L'EQUIPEMENT

Ne dépassez aucune évaluation spécifiée dans le tableau de caractéristiques environnementales et électriques..

Le fait de ne pas suivre les instructions peut entraîner une défaillance de la protection fournie par l'équipement, ce qui peut entraîner des conséquences graves, comme des blessures ou des dommages à l'équipement.

3 Hardware interfaces

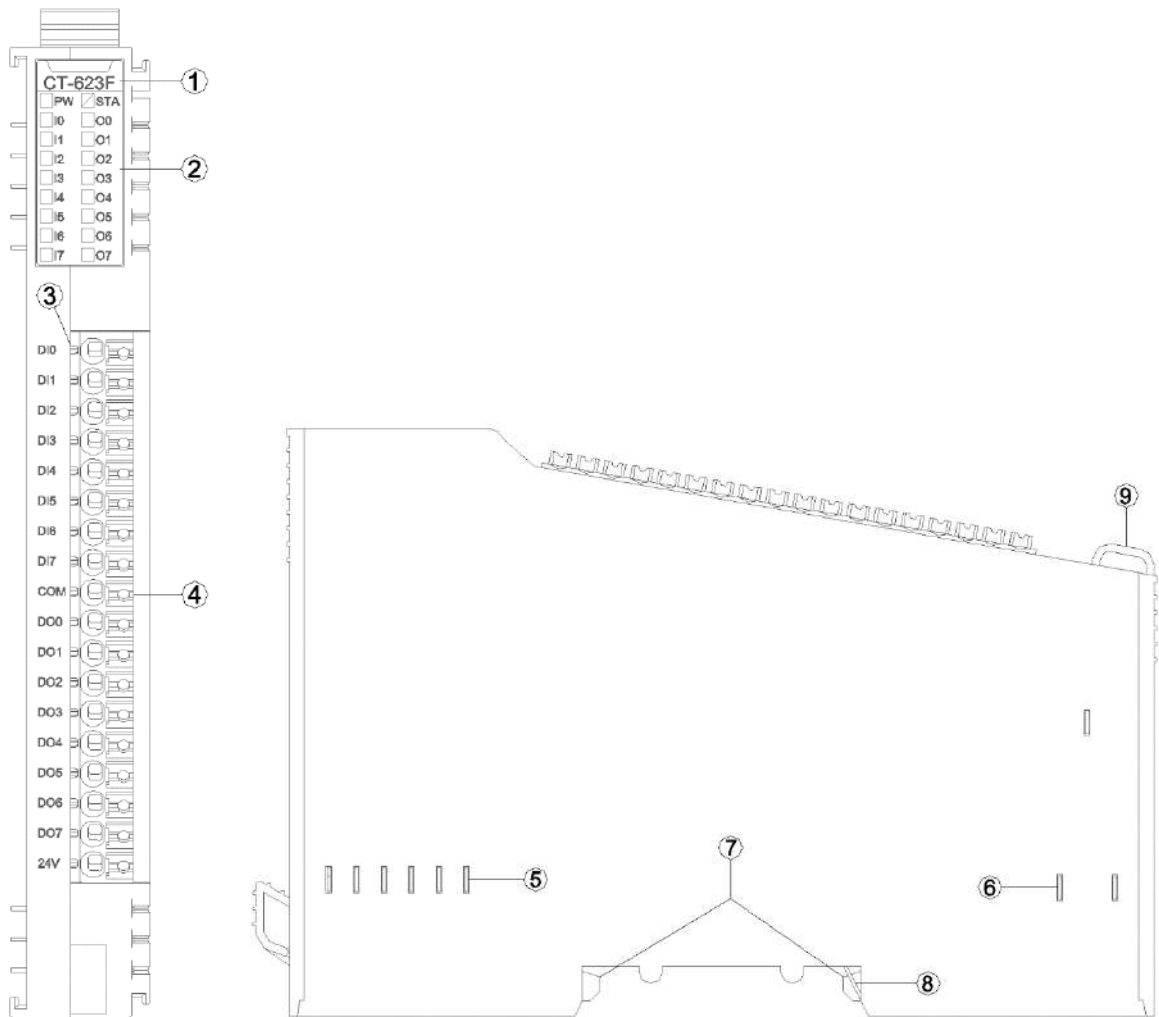

- ① Module Type
- ② State indicators
- ③ Channel indicators
- ④ Wiring Terminal and Marking
- ⑤ Internal Bus
- ⑥ Field Power
- ⑦ Buckle
- ⑧ Grounding Spring Sheet
- ⑨ Fixed Wiring Harness

3.1 LED indicators Definition

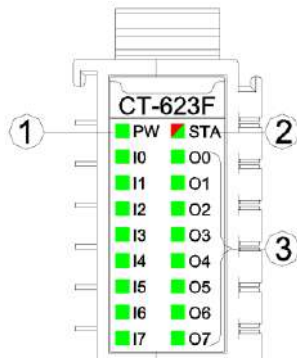

- ① Power indicator (green)
- ② Module state indicator (red/green)
- ③ Input/output channel indicators (green)

PW power indicator	Definition
ON	Internal bus power supply normal
OFF	Internal bus power supply failure
STA module state indicator	Definition
Green slow flash (2.5hz)	The internal bus of the module is not started
Red slow flash (2.5hz)	Module internal bus offline
Green normally on	Module works normally
Flash(2.5Hz) (RED/GREEN)	Operating mode
Flash(10Hz) (RED/GREEN)	Firmware upgrading
Red flashes twice	Module exception has been soft-restarted
I0-I7 input channel indicators	Definition
ON	input signal valid
OFF	input signal invalid
O0-O7 output channel indicators	Definition
ON	Output signal valid
OFF	Output signal invalid

⚠ WARNING

UNEXPECTED EQUIPMENT OPERATION

By viewing the PW indicator, could determine the power supply status of a module. If the PW is steady green, the power supply is normal. Otherwise, the module cannot work properly.

When the module is initially powered on, there will be 3S for the backplane bus connection. After the backplane bus is initialized, STA is in the green steady state. If STA is in the green blinking state, it indicates that the backplane bus has not been initialized, and it needs to be powered off and restarted for re-initialization.

STA abnormal working state occurs during the normal operation of the module, please check the

firmware version information of all modules, and consult ODOT technical support for details.
If a module is upgraded, check that all modules are in the normal state after the upgrade.
Otherwise, an exception may occur.

Failure to follow instructions specified by the manufacturer may result in serious consequences such as death, personal injury, or damage to equipment since the protection provided by the equipment may be impaired.

AVERTISSEMENT

FONCTIONNEMENT INATTENDU DE L'EQUIPEMENT

En regardant l'état de l'indicateur de PW, jugez l'état d'alimentation du module. Le feu vert PW reste allumé et l'alimentation est normale. Autrement, le module ne fonctionnera pas correctement.

Lorsque le module est alimenté initialement, il y aura 3S pour la connexion de bus de backboard. STA est un état vert permanent après l'initialisation du bus de backboard. Si STA est en état de clignotement vert, cela signifie que l'initialisation du bus de backboard n'est pas passée et doit être redémarrée hors tension et réinitialisée.

L'état de fonctionnement anormal de STA se produit pendant le fonctionnement normal du module, veuillez vérifier les informations de version du firmware de tous les modules, et consulter le support technique ODOT pour plus de détails.

Si le module a une opération de mise à niveau, après l'achèvement de la mise à niveau, le besoin de vérifier que tous les modules sont dans l'état normal avant de courir, sinon il conduira à une exception.

Le fait de ne pas suivre les instructions peut entraîner une défaillance de la protection fournie par l'équipement, ce qui peut entraîner des conséquences graves, comme des blessures ou des dommages à l'équipement.

3.2 Field input channel LED indicator (red/green)

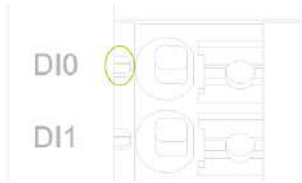

When the COM terminal is connected to a low level and the input channel signal is at a high level, the corresponding channel green indicator is on.

When the COM terminal is connected to a high level and the input channel signal is at a low level, the corresponding channel red indicator is on.

3.3 Field output channel LED indicator (green)



When the output signal of the output channel is valid, the corresponding channel indicator is on.

3.4 Terminal definition

Terminal Number	Symbol	Instruction
1	DI0	Signal input
2	DI1	
3	DI2	
4	DI3	
5	DI4	
6	DI5	
7	DI6	
8	DI7	
9	COM	Input common terminal
10	DO0	Signal output
11	DO1	
12	DO2	
13	DO3	
14	DO4	
15	DO5	
16	DO6	
17	DO7	
18	24V	Power input (<i>Note1</i>)

Note 1: when the red LED indicator beside the 24V wiring terminal lights up, it indicates that the fieldbus is powered on, then the maximum output current of each channel is 500mA, and the maximum sum of all output channel currents is 2A.

When the 24VDC power is supplied to the 24V wiring terminal separately, the sum of all the output channel currents is at the maximum of 4A (Whether the fieldbus is powered on or not, 24V wiring terminals can both be connected to 24VDC power supply).

WARNING

UNEXPECTED EQUIPMENT OPERATION

Calculate the maximum field power current consumption of a single module based on the actual field load. If the total field power current consumption of all I/O modules exceeds the power supply capacity of the field power supply, you must add an extra power expansion module. Otherwise, an output channel exception may occur.

Failure to follow instructions specified by the manufacturer may result in serious consequences such as death, personal injury, or damage to equipment since the protection provided by the equipment may be impaired.

AVERTISSEMENT

FONCTIONNEMENT INATTENDU DE L'EQUIPEMENT

Calculez la consommation maximale de courant de champ d'un seul module en fonction de la charge de champ réelle. Si la consommation totale de courant de champ de tous les modules d'E/S dépasse la capacité d'alimentation de l'alimentation de champ, vous devez ajouter un module d'extension de puissance supplémentaire. Dans le cas contraire, une exception de canal de sortie peut se produire.

Le fait de ne pas suivre les instructions peut entraîner une défaillance de la protection fournie par l'équipement, ce qui peut entraîner des conséquences graves, comme des blessures ou des dommages à l'équipement.

When connecting a cold-pressed terminal, the terminal must be terminated and checked in strict accordance with the corresponding termination specifications or requirements, and connect the cold-pressed terminal according to the corresponding node serial number. The conductor should use copper conductor and the conductor core should be larger than 0.2mm² and smaller than 1mm² (AWG18~AWG24). Cold-pressed terminal parameters are as follows:

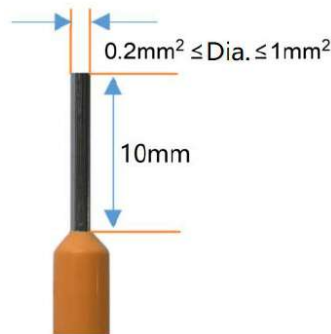

! WARNING

UNEXPECTED EQUIPMENT OPERATION

Strip the length of the conductor insulation layer is greater than 10mm to ensure reliable signal connection.

The wire needs to use copper wire and the wire core is greater than or equal to 0.2mm² and less than or equal to 1mm² to ensure reliable signal connection.

When connecting a cold-press terminal, connect the cold-press terminal strictly in accordance with the corresponding termination specifications or requirements, and connect the cold-press terminal according to the corresponding node serial number.

Do not power on cold-press terminals until they are properly connected or fully locked.

Failure to follow instructions specified by the manufacturer may result in serious consequences such as death, personal injury, or damage to equipment since the protection provided by the equipment may be impaired.

AVERTISSEMENT

FONCTIONNEMENT INATTENDU DE L'EQUIPEMENT

Dépouillez la longueur de la couche isolante du fil plus de 10mm pour assurer la connexion fiable du signal.

Le conducteur doit utiliser le fil de cuivre et le noyau de fil est supérieur ou égal à 0,2 mm², inférieur ou égal à 1mm², afin d'assurer la connexion fiable du signal.

Lorsque les terminaux de presse à froid sont terminés, ils doivent être terminés et visualisés en stricte conformité avec les spécifications ou les exigences correspondantes et terminés selon le numéro de série de noeud correspondant.

Il est interdit d'activer les bornes à froid avant qu'elles ne soient correctement articulées ou complètement verrouillées.

Le fait de ne pas suivre les instructions peut entraîner une défaillance de la protection fournie par l'équipement, ce qui peut entraîner des conséquences graves, comme des blessures ou des dommages à l'équipement.

DANGER

FIRE DANGER

Use the correct wiring rules only for the maximum current capacity of the I/O channel and power supply.

Failure to follow instructions specified by the manufacturer may result in serious consequences such as death, personal injury, or damage to equipment since the protection provided by the equipment may be impaired.

WARNING

UNEXPECTED EQUIPMENT OPERATION

Do not exceed any of the ratings specified in the environmental and electrical characteristics table.

Failure to follow instructions specified by the manufacturer may result in serious consequences such as death, personal injury, or damage to equipment since the protection provided by the equipment may be impaired.

AVERTISSEMENT

FONCTIONNEMENT INATTENDU DE L'EQUIPEMENT

Ne dépassez aucune évaluation spécifiée dans le tableau de caractéristiques environnementales et électriques..

Le fait de ne pas suivre les instructions peut entraîner une défaillance de la protection fournie par l'équipement, ce qui peut entraîner des conséquences graves, comme des blessures ou des dommages à l'équipement.

4 Wiring

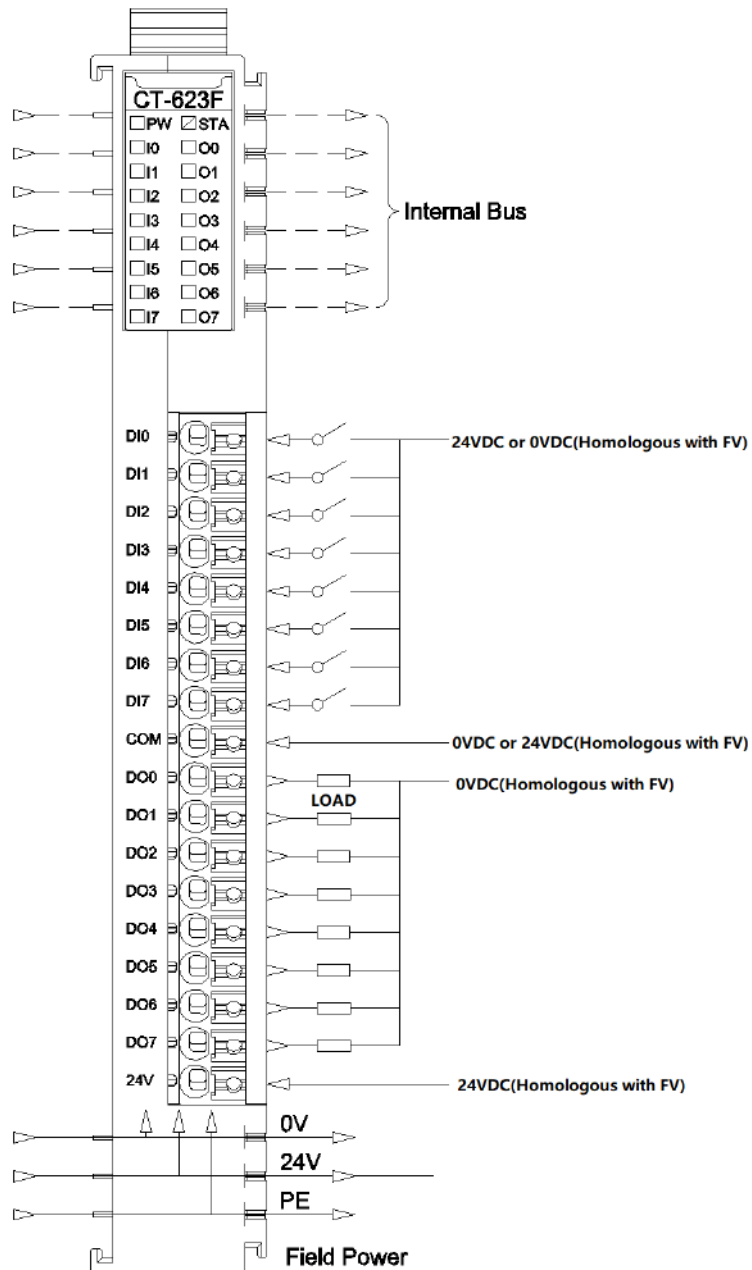

NOTICE

EQUIPMENT INOPERABLE

Do not crimp the spring terminal with more than the maximum pressure specified for the terminal. Otherwise, the resilience of the spring terminal may be damaged and the terminal rebound may be affected.

Do not press the spring terminal with a sharp tool when removing cable from the channel. Otherwise, the spring terminal will be damaged.

Failure to follow these instructions may result in equipment damage.

5 Process data definition

<8DI&8DO IO State> Submodule procedure data definition

Input data								
Bit No	Bit 7	Bit 6	Bit 5	Bit 4	Bit 3	Bit 2	Bit 1	Bit 0
Byte 0	DI Ch#7	DI Ch#6	DI Ch#5	DI Ch#4	DI Ch#3	DI Ch#2	DI Ch#1	DI Ch#0
Output data								
Bit No	Bit 7	Bit 6	Bit 5	Bit 4	Bit 3	Bit 2	Bit 1	Bit 0
Byte 0	DO Ch#7	DO Ch#6	DO Ch#5	DO Ch#4	DO Ch#3	DO Ch#2	DO Ch#1	DO Ch#0

Data description:

DI Ch#(0-7): When the corresponding channel input signal is valid, the bit is 1, and when the input is invalid, it is 0.

0: Input signal invalid

1: Input signal valid

DO Ch#(0-7): when this bit is 1, the corresponding channel output signal is valid, the output is high level, and the output is invalid when it is 0.

0: Output signal invalid

1: Output signal valid

<8DI Counter Submodule> Submodule process data definition.

Input data								
Bit No	Bit 7	Bit 6	Bit 5	Bit 4	Bit 3	Bit 2	Bit 1	Bit 0
Byte 0	Counter Value Ch#0							
Byte 1								
Byte 2								
Byte 3								
Byte 4	Counter Value Ch#1							
Byte 5								
Byte 6								
Byte 7								
Byte 8	Counter Value Ch#2							
Byte 9								
Byte 10								
Byte 11								
Byte 12	Counter Value Ch#3							
Byte 13								
Byte 14								
Byte 15								

Byte 16	Counter Value Ch#4							
Byte 17								
Byte 18								
Byte 19								
Byte 20	Counter Value Ch#5							
Byte 21								
Byte 22								
Byte 23								
Byte 24	Counter Value Ch#6							
Byte 25								
Byte 26								
Byte 27								
Byte 28	Counter Value Ch#7							
Byte 29								
Byte 30								
Byte 31								
Output data								
Bit No	Bit 7	Bit 6	Bit 5	Bit 4	Bit 3	Bit 2	Bit 1	Bit 0
Byte 0	Counter Reset Ch#7	Counter Reset Ch#6	Counter Reset Ch#5	Counter Reset Ch#4	Counter Reset Ch#3	Counter Reset Ch#2	Counter Reset Ch#1	Counter Reset Ch#0

Data description:

Counter Value Ch#(0-7): count value, 32-bit unsigned integer, automatically zeroing after overflow.

Counter Reset Ch#(0-7): when the data bit changes from 0 to 1 (rising edge), the input counter of the corresponding channel will be cleared.

Note: The maximum counting frequency of the input channel is 200Hz. When the input signal exceeds this frequency, the counting result may be inconsistent with the actual value.

6 Configuration parameter definition

<8DI&8DO IO State> Submodule configuration parameter definition

Configuration parameter								
Bit No	Bit 7	Bit 6	Bit 5	Bit 4	Bit 3	Bit 2	Bit 1	Bit 0
Byte 0	Input Filtering Time(ms)							
Byte 1								
Byte 2	Reserved					Input Holding Time(ms)		
Byte 3	Fault Action for Output Ch#7	Fault Action for Output Ch#6	Fault Action for Output Ch#5	Fault Action for Output Ch#4	Fault Action for Output Ch#3	Fault Action for Output Ch#2	Fault Action for Output Ch#1	Fault Action for Output Ch#0
Byte 4	Fault Value for Output Ch#7	Fault Value for Output Ch#6	Fault Value for Output Ch#5	Fault Value for Output Ch#4	Fault Value for Output Ch#3	Fault Value for Output Ch#2	Fault Value for Output Ch#1	Fault Value for Output Ch#0

Data description:

Input Filtering Time(ms): Channel input filtering time, unit: ms. (Default: 10)

Input Holding Time(ms): Channel input signal holding time, unit: ms. (Default: 0)

- 0: Disable
- 1: 200ms
- 2: 500ms
- 3: 1000ms
- 4: 1500ms
- 5: 2000ms
- 6: 3000ms
- 7: 5000ms

Fault Action for Output Ch#(0-7): Fault Output mode. When the IO module detects an internal bus exception and fails to communicate with the adapter, the module enters offline mode, the output data will be processed in this way. (Default: 0)

- 0: keep the last time output state.
- 1: output fault value.

Fault Value for Output Ch#(0-7): When the fault output mode is 1, the bit sets the fault output value, which is output when the IO module internal bus is offline. (Default:

0)

0: output low level.

1: output high level.

<8DI Counter Submodule> Submodule configuration parameter definition

Configuration parameter								
Bit No	Bit 7	Bit 6	Bit 5	Bit 4	Bit 3	Bit 2	Bit 1	Bit 0
Byte 0	Reserved				Storage Enable	Storage Function	32Bit Data Format	
Byte 1	Count Mode Ch#3		Count Mode Ch#2		Count Mode Ch#1		Count Mode Ch#0	
Byte 2	Count Mode Ch#7		Count Mode Ch#6		Count Mode Ch#5		Count Mode Ch#4	
Byte 3	Count Direction Ch#7	Count Direction Ch#6	Count Direction Ch#5	Count Direction Ch#4	Count Direction Ch#3	Count Direction Ch#2	Count Direction Ch#1	Count Direction Ch#0

Data description:

32Bit Data Format: Byte transmission order of channel count values (Default: 0).

0: AB-CD

1: BA-DC

2: CD-AB

3: DC-BA

Storage Function: storage Function is support or not, read only, and this value is the actual value of the module when uploading device parameters.

0: storage is not support

1: storage is support

Storage Enable: Storage enable, when the Storage Function enables, the IO module will save the count value in real time to non-volatile memory, and load the last saved count value when it is powered on next time. (Default: 1)

0: Disabled

1: Enable

Count Mode Ch#(0-7): Input channel count mode. (Default: 0)

0: Rising edge count

1: Falling edge count

2: Double edge count

Count Direction Ch#(0-7): The counting direction of the input channel. (Default: 0)

0: Count up

1: Count down

 **WARNING**

UNEXPECTED EQUIPMENT OPERATION

Adjust the parameters according to the site conditions. If the parameters are improperly set, the output signal will be incorrect.

Failure to follow instructions specified by the manufacturer may result in serious consequences such as death, personal injury, or damage to equipment since the protection provided by the equipment may be impaired.

 **AVERTISSEMENT**

FONCTIONNEMENT INATTENDU DE L'EQUIPEMENT

Les paramètres peuvent être ajustés en fonction des conditions du site. Si les paramètres ne sont pas réglés correctement, il en résultera un signal de sortie erroné.

Le fait de ne pas suivre les instructions peut entraîner une défaillance de la protection fournie par l'équipement, ce qui peut entraîner des conséquences graves, comme des blessures ou des dommages à l'équipement.

A Dimension drawing

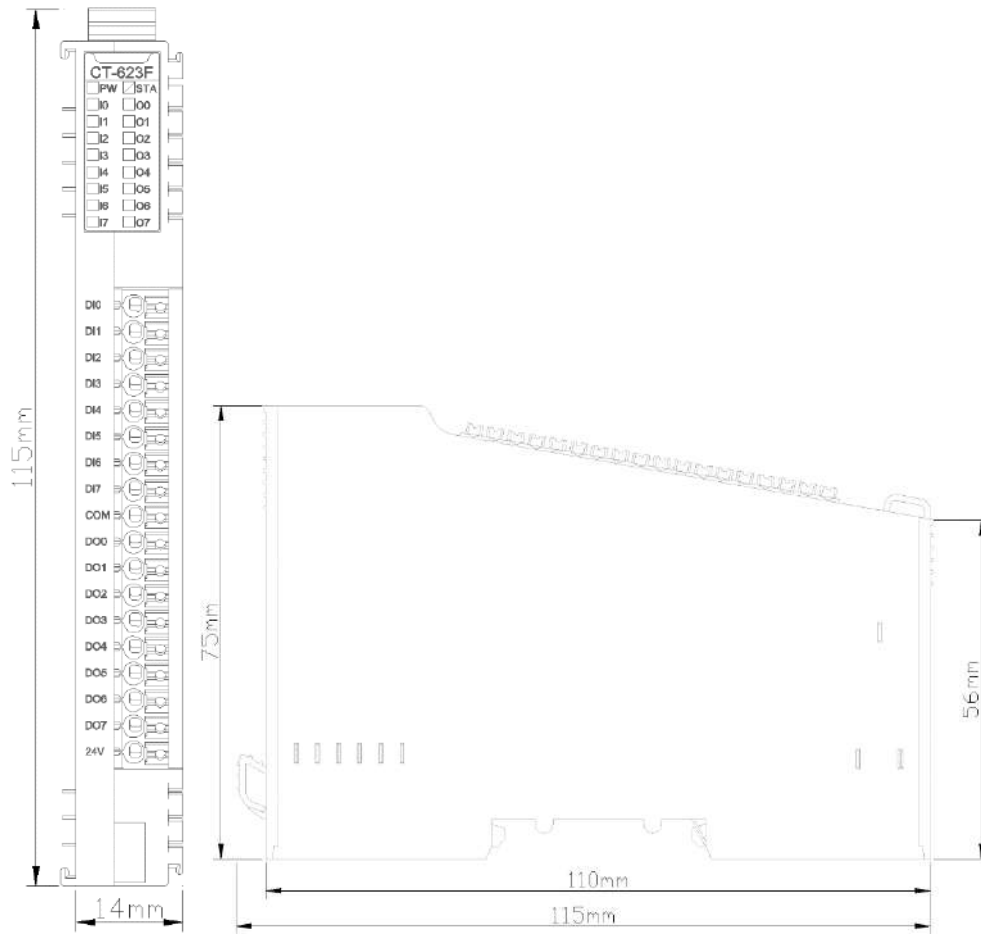

CT-7100 Field Power Expansion Module 8A (no configuration required)

1 Module features

- ◆ Field power supply expansion
- ◆ Field power supply extends 8A current
- ◆ No configuration is required and no slots are occupied

2 Technical parameters

General parameter	
Field power	Supply: 20.4-28.8VDC (Nominal : 24VDC) Protection: Reverse Protection
Field power current	MAX: DC 8A
Environment parameter	
Operating Temperature of Horizontal Installation	-35°C~70°C
Operating Temperature of Vertical Installation	-35°C~60°C
Relative Humidity	<95%RH No condensation
Storage Temperature	-40°C~85°C
Storage Humidity	<95%RH No condensation
Manufacturing Test Temperature	-40°C~75°C
Ingress Protection Rating	IP20

WARNING

UNEXPECTED EQUIPMENT OPERATION

Do not exceed any of the ratings specified in the environmental and electrical characteristics table.

Failure to follow instructions specified by the manufacturer may result in serious consequences such as death, personal injury, or damage to equipment since the protection provided by the equipment may be impaired.

AVERTISSEMENT

FONCTIONNEMENT INATTENDU DE L'EQUIPEMENT

Ne dépassez aucune évaluation spécifiée dans le tableau de caractéristiques environnementales et électriques..

Le fait de ne pas suivre les instructions peut entraîner une défaillance de la protection fournie par l'équipement, ce qui peut entraîner des conséquences graves, comme des blessures ou des dommages à l'équipement.

3 Hardware interfaces

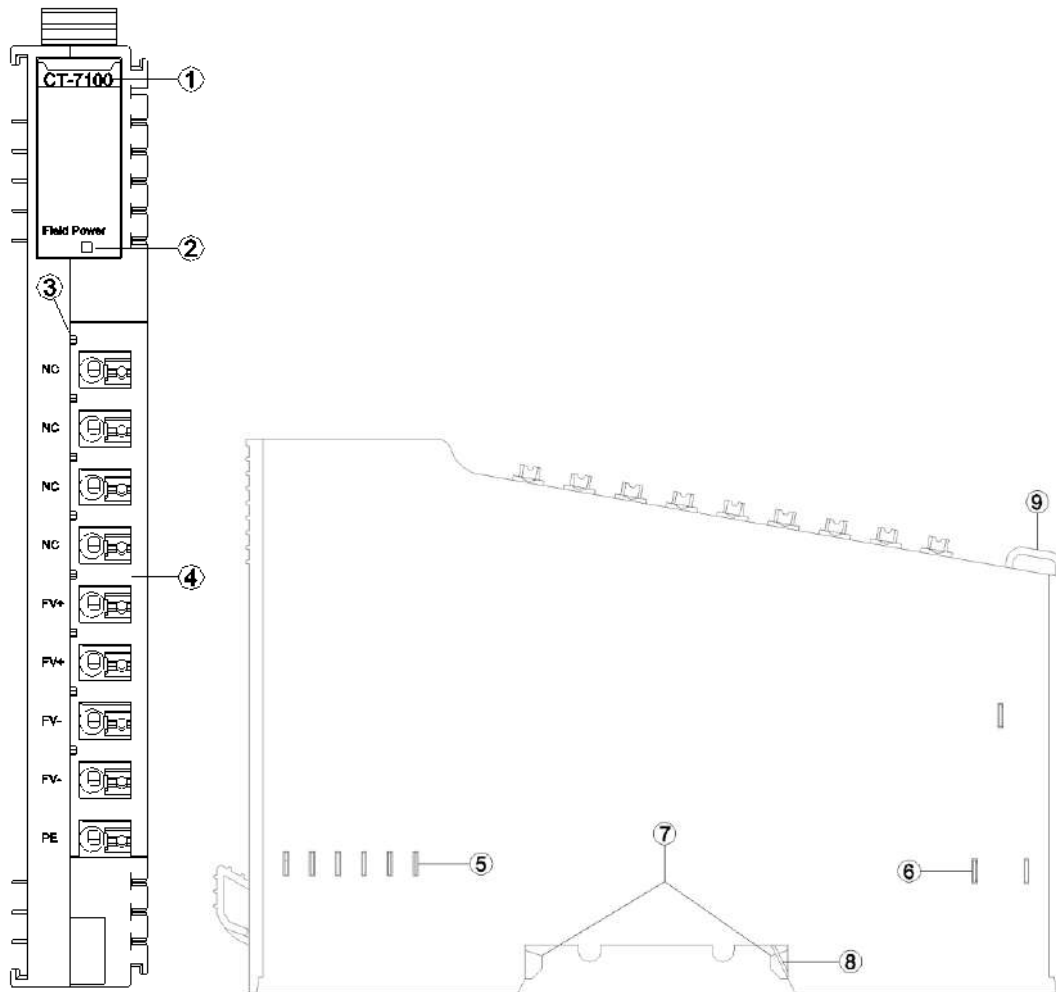

- ① Module Type
- ② State indicator
- ③ N/A
- ④ Wiring Terminal and identification
- ⑤ Internal Bus
- ⑥ Field Power
- ⑦ Buckle
- ⑧ Grounding Spring Sheet
- ⑨ Fixed Wiring Harness

3.1 LED indicator definition

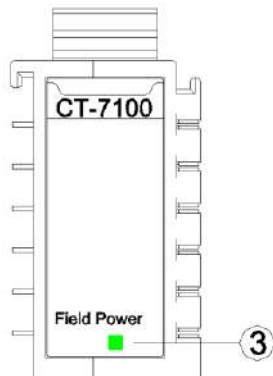

③ Field power indicator(green)

Field Power indicator(green)	Definition
ON	Field power supply normal
OFF	Field power supply abnormal

WARNING

UNEXPECTED EQUIPMENT OPERATION

By viewing the PW indicator, could determine the power supply status of a module. If the PW is steady green, the power supply is normal. Otherwise, the module cannot work properly.

When the module is initially powered on, there will be 3S for the backplane bus connection. After the backplane bus is initialized, STA is in the green steady state. If STA is in the green blinking state, it indicates that the backplane bus has not been initialized, and it needs to be powered off and restarted for re-initialization.

STA abnormal working state occurs during the normal operation of the module, please check the firmware version information of all modules, and consult ODOT technical support for details.

If a module is upgraded, check that all modules are in the normal state after the upgrade. Otherwise, an exception may occur.

Failure to follow instructions specified by the manufacturer may result in serious consequences such as death, personal injury, or damage to equipment since the protection provided by the equipment may be impaired.

AVERTISSEMENT

FONCTIONNEMENT INATTENDU DE L'EQUIPEMENT

En regardant l'état de l'indicateur de PW, jugez l'état d'alimentation du module. Le feu vert PW reste allumé et l'alimentation est normale. Autrement, le module ne fonctionnera pas correctement.

Lorsque le module est alimenté initialement, il y aura 3S pour la connexion de bus de backboard. STA est un état vert permanent après l'initialisation du bus de backboard. Si STA est en état de

clignotement vert, cela signifie que l'initialisation du bus de backboard n'est pas passée et doit être redémarrée hors tension et réinitialisée.

L'état de fonctionnement anormal de STA se produit pendant le fonctionnement normal du module, veuillez vérifier les informations de version du firmware de tous les modules, et consulter le support technique ODOT pour plus de détails.

Si le module a une opération de mise à niveau, après l'achèvement de la mise à niveau, le besoin de vérifier que tous les modules sont dans l'état normal avant de courir, sinon il conduira à une exception.

Le fait de ne pas suivre les instructions peut entraîner une défaillance de la protection fournie par l'équipement, ce qui peut entraîner des conséquences graves, comme des blessures ou des dommages à l'équipement.

3.2 Terminal definition

Terminal number	Definition	Instruction
1	NC	N/A
2	NC	
3	NC	
4	NC	
5	FV+	Field power positive pole
6	FV+	
7	FV-	Field power negative pole
8	FV-	
9	PE	System ground

When connecting a cold-pressed terminal, the terminal must be terminated and checked in strict accordance with the corresponding termination specifications or requirements, and connect the cold-pressed terminal according to the corresponding node serial number. The conductor should use copper conductor and the conductor core should be larger than 0.2mm² and smaller than 1mm² (AWG18~AWG24). Cold-pressed terminal parameters are as follows:

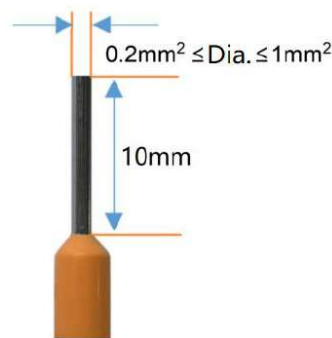

WARNING

UNEXPECTED EQUIPMENT OPERATION

Strip the length of the conductor insulation layer is greater than 10mm to ensure reliable signal connection.

The wire needs to use copper wire and the wire core is greater than or equal to 0.2mm² and less than or equal to 1mm² to ensure reliable signal connection.

When connecting a cold-press terminal, connect the cold-press terminal strictly in accordance with the corresponding termination specifications or requirements, and connect the cold-press terminal according to the corresponding node serial number.

Do not power on cold-press terminals until they are properly connected or fully locked.

Failure to follow instructions specified by the manufacturer may result in serious consequences such as death, personal injury, or damage to equipment since the protection

provided by the equipment may be impaired.

AVERTISSEMENT

FONCTIONNEMENT INATTENDU DE L'EQUIPEMENT

Dépouillez la longueur de la couche isolante du fil plus de 10mm pour assurer la connexion fiable du signal.

Le conducteur doit utiliser le fil de cuivre et le noyau de fil est supérieur ou égal à 0,2 mm², inférieur ou égal à 1mm², afin d'assurer la connexion fiable du signal.

Lorsque les terminaux de presse à froid sont terminés, ils doivent être terminés et visualisés en stricte conformité avec les spécifications ou les exigences correspondantes et terminés selon le numéro de série de noeud correspondant.

Il est interdit d'activer les bornes à froid avant qu'elles ne soient correctement articulées ou complètement verrouillées.

Le fait de ne pas suivre les instructions peut entraîner une défaillance de la protection fournie par l'équipement, ce qui peut entraîner des conséquences graves, comme des blessures ou des dommages à l'équipement.

DANGER

FIRE DANGER

Use the correct wiring rules only for the maximum current capacity of the I/O channel and power supply.

Failure to follow instructions specified by the manufacturer may result in serious consequences such as death, personal injury, or damage to equipment since the protection provided by the equipment may be impaired.

WARNING

UNEXPECTED EQUIPMENT OPERATION

Do not exceed any of the ratings specified in the environmental and electrical characteristics table.

Failure to follow instructions specified by the manufacturer may result in serious consequences such as death, personal injury, or damage to equipment since the protection provided by the equipment may be impaired.

AVERTISSEMENT

FONCTIONNEMENT INATTENDU DE L'EQUIPEMENT

Ne dépassez aucune évaluation spécifiée dans le tableau de caractéristiques environnementales

et électriques..

Le fait de ne pas suivre les instructions peut entraîner une défaillance de la protection fournie par l'équipement, ce qui peut entraîner des conséquences graves, comme des blessures ou des dommages à l'équipement.

4 Wiring

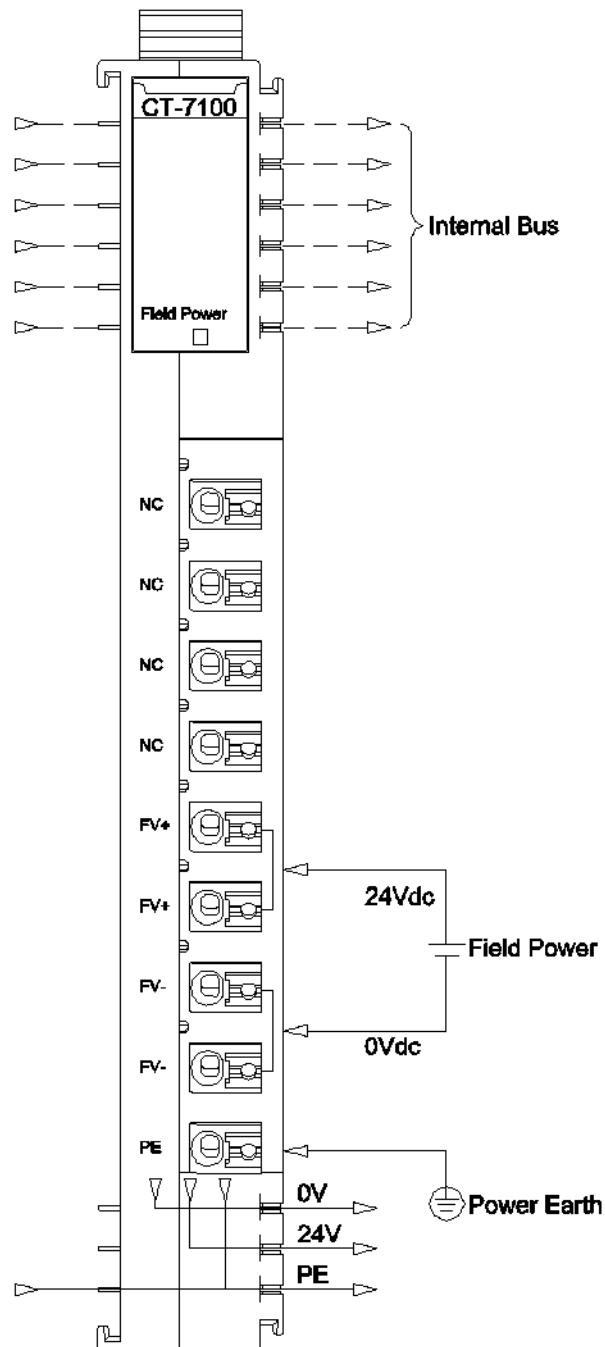

⚠️ WARNING

UNEXPECTED EQUIPMENT OPERATION

Inside the module, two terminals FV+ and two terminals FV- have been shorted. These four terminals must be independently and reliably connected to the onsite power supply.

Failure to follow instructions specified by the manufacturer may result in serious consequences such as death, personal injury, or damage to equipment since the protection provided by the equipment may be impaired.

AVERTISSEMENT

FONCTIONNEMENT INATTENDU DE L'EQUIPEMENT

À l'intérieur du module, les deux bornes FV+ sont connectées et les deux bornes FV- sont connectées. Ces quatre bornes doivent être connectées séparément et de manière fiable à l'alimentation sur site.

Le fait de ne pas suivre les instructions peut entraîner une défaillance de la protection fournie par l'équipement, ce qui peut entraîner des conséquences graves, comme des blessures ou des dommages à l'équipement.

NOTICE

EQUIPMENT INOPERABLE

Do not crimp the spring terminal with more than the maximum pressure specified for the terminal. Otherwise, the resilience of the spring terminal may be damaged and the terminal rebound may be affected.

Do not press the spring terminal with a sharp tool when removing cable from the channel. Otherwise, the spring terminal will be damaged.

Failure to follow these instructions may result in equipment damage.

5 Process data definition

No process data.

6 configuration parameters definition

No configuration parameters.

A Dimension drawing

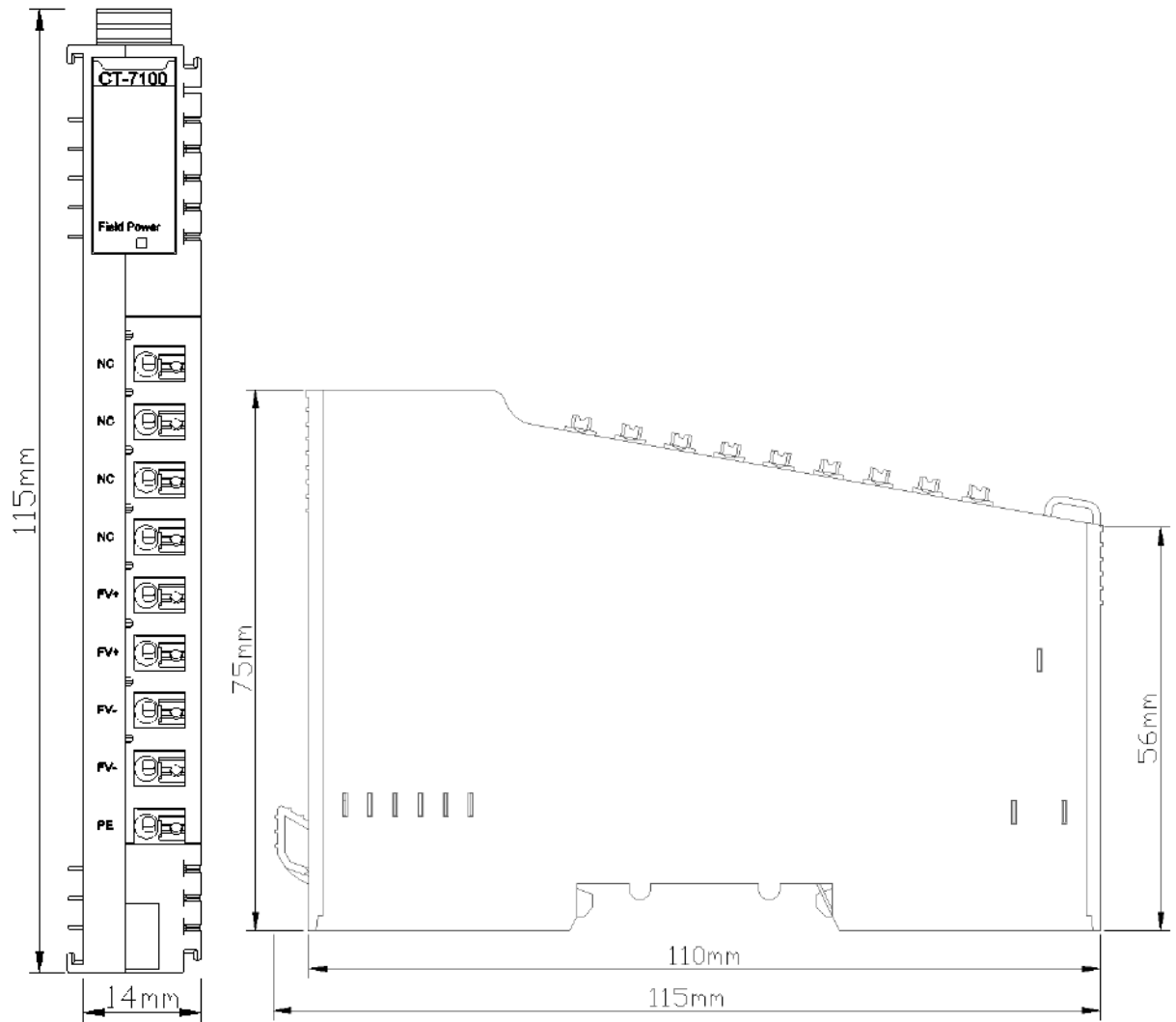

CT-7220 Power Supply Extension Module 5V/2A (requires no configuration)

1 Module features

- ◆ System Power and Field Power Extension
- ◆ System Power Output 2A@5VDC
- ◆ Field Power Extension 8A Current
- ◆ Requires no configuration and occupies no slot in configuration.

2 Technical Parameters

General Parameters	
System Power	Supply: 20-30VDC (Nominal: 24VDC) Current: Max.2A@24VDC Protection: overcurrent protection, anti-reverse connection protection
Internal Bus Supply Current	Max: 2.0A@5VDC
Isolation	System Power to Field Power Isolation
Field Power	Power Supply: 20.4~28.8V (Nominal: 24Vdc) Protection: anti-reverse connection protection
Field Power Supply Current	Max. DC 8A
Vibration Resistance	Comply with IEC 61131-2 and EC 60068-2-6
Impact resistance	Comply with IEC 61131-2 and IEC 60068-2-27
EMC Performance	Comply with IEC 61131-2 and IEC 61000-4
Environment Specification	
Operating Temperature of Horizontal Installation	-35°C~70°C
Operating Temperature of Vertical Installation	-35°C~60°C
Relative Humidity	< 95%RH (No Condensation)
Storage Temperature	-40°C~85°C
Storage Humidity	< 95%RH (No Condensation)
Manufacturing Test Temperature	-40°C~75°C
Ingress Protection Rating	IP20

WARNING

UNEXPECTED EQUIPMENT OPERATION

Do not exceed any of the ratings specified in the environmental and electrical characteristics table.

Failure to follow instructions specified by the manufacturer may result in serious consequences such as death, personal injury, or damage to equipment since the protection provided by the equipment may be impaired.

AVERTISSEMENT

FONCTIONNEMENT INATTENDU DE L'EQUIPEMENT

Ne dépassez aucune évaluation spécifiée dans le tableau de caractéristiques environnementales et électriques..

Le fait de ne pas suivre les instructions peut entraîner une défaillance de la protection

fournie par l'équipement, ce qui peut entraîner des conséquences graves, comme des blessures ou des dommages à l'équipement.

3 Hardware Interface

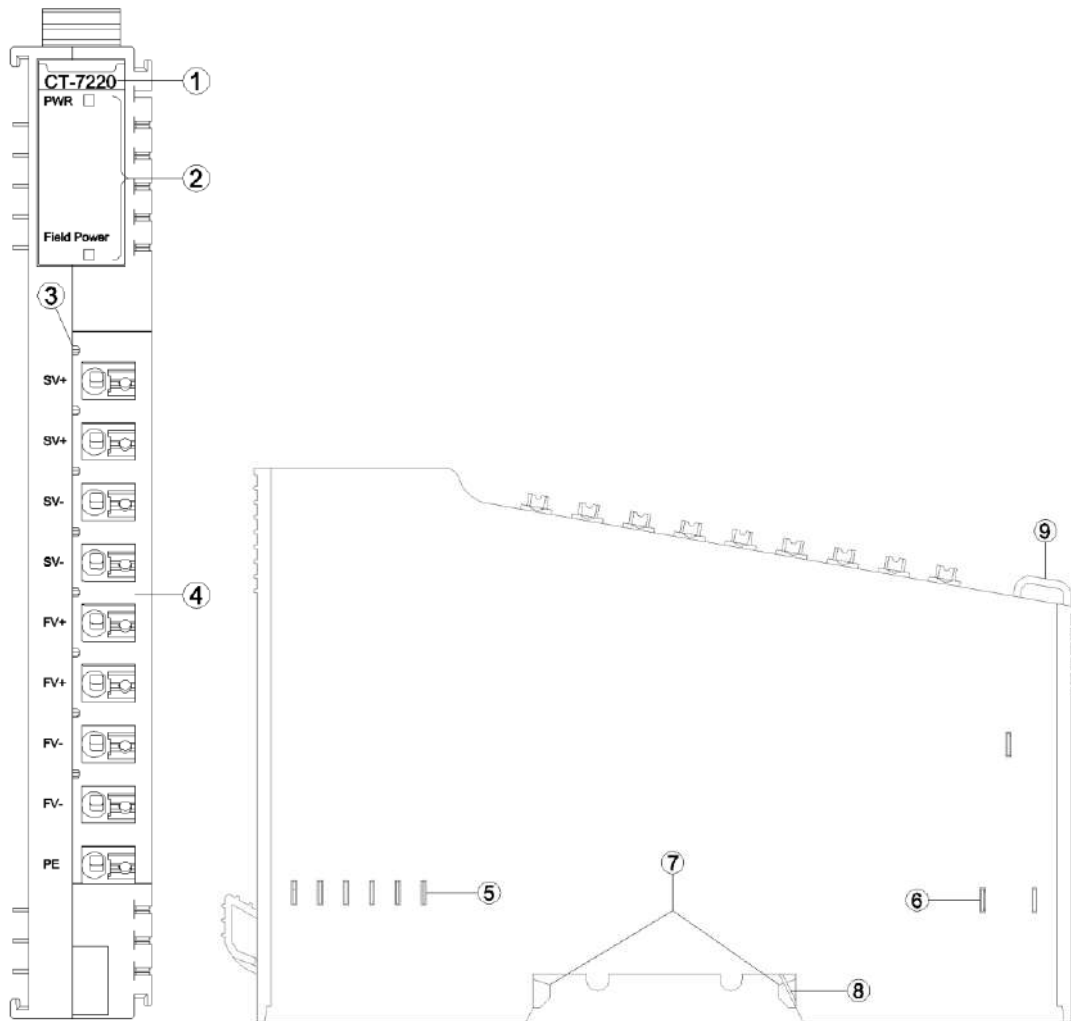

- ① Module Type
- ② State indicator
- ③ N/A
- ④ Wiring Terminal and identification
- ⑤ Internal Bus
- ⑥ Field Power
- ⑦ Buckle
- ⑧ Grounding Spring Sheet
- ⑨ Fixed Wiring Harness

3.1 LED indicator definition

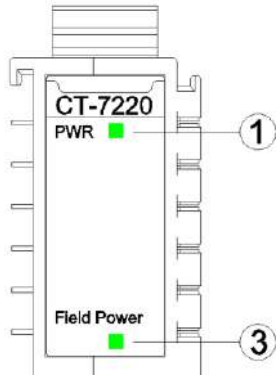

- ① System Power LED Indicator (green)
- ③ Field Power LED Indicator (green)

PWR Power LED Indicator (GREEN)	Definition
ON	The system power supply is normal.
OFF	The system power supply is failure.
Field Power LED Indicator (GREEN)	Definition
ON	The field power supply is normal.
OFF	The field power supply is failure.

⚠️ WARNING

UNEXPECTED EQUIPMENT OPERATION

By viewing the PW indicator, could determine the power supply status of a module. If the PW is steady green, the power supply is normal. Otherwise, the module cannot work properly.

When the module is initially powered on, there will be 3S for the backplane bus connection. After the backplane bus is initialized, STA is in the green steady state. If STA is in the green blinking state, it indicates that the backplane bus has not been initialized, and it needs to be powered off and restarted for re-initialization.

STA abnormal working state occurs during the normal operation of the module, please check the firmware version information of all modules, and consult ODOT technical support for details.

If a module is upgraded, check that all modules are in the normal state after the upgrade. Otherwise, an exception may occur.

Failure to follow instructions specified by the manufacturer may result in serious consequences such as death, personal injury, or damage to equipment since the protection provided by the equipment may be impaired.

⚠️ AVERTISSEMENT

FONCTIONNEMENT INATTENDU DE L'EQUIPEMENT

En regardant l'état de l'indicateur de PW, jugez l'état d'alimentation du module. Le feu vert PW reste allumé et l'alimentation est normale. Autrement, le module ne fonctionnera pas correctement.

Lorsque le module est alimenté initialement, il y aura 3S pour la connexion de bus de backboard. STA est un état vert permanent après l'initialisation du bus de backboard. Si STA est en état de clignotement vert, cela signifie que l'initialisation du bus de backboard n'est pas passée et doit être redémarrée hors tension et réinitialisée.

L'état de fonctionnement anormal de STA se produit pendant le fonctionnement normal du module, veuillez vérifier les informations de version du firmware de tous les modules, et consulter le support technique ODOT pour plus de détails.

Si le module a une opération de mise à niveau, après l'achèvement de la mise à niveau, le besoin de vérifier que tous les modules sont dans l'état normal avant de courir, sinon il conduira à une exception.

Le fait de ne pas suivre les instructions peut entraîner une défaillance de la protection fournie par l'équipement, ce qui peut entraîner des conséquences graves, comme des blessures ou des dommages à l'équipement.

3.2 Terminal definition

Terminal Number	Definition	Description
1	SV+	System Power Positive Pole
2	SV+	
3	SV-	System Power Negative Pole
4	SV-	
5	FV+	Field Power Positive Pole
6	FV+	
7	FV-	Field Power Negative Pole
8	FV-	
9	PE	System Grounded

When connecting a cold-pressed terminal, the terminal must be terminated and checked in strict accordance with the corresponding termination specifications or requirements, and connect the cold-pressed terminal according to the corresponding node serial number. The conductor should use copper conductor and the conductor core should be larger than 0.2mm² and smaller than 1mm² (AWG18~AWG24). Cold-pressed terminal parameters are as follows:

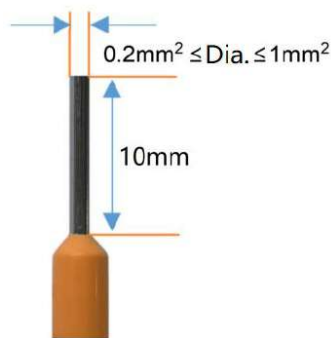

! WARNING

UNEXPECTED EQUIPMENT OPERATION

Strip the length of the conductor insulation layer is greater than 10mm to ensure reliable signal connection.

The wire needs to use copper wire and the wire core is greater than or equal to 0.2mm² and less than or equal to 1mm² to ensure reliable signal connection.

When connecting a cold-press terminal, connect the cold-press terminal strictly in accordance with the corresponding termination specifications or requirements, and connect the cold-press terminal according to the corresponding node serial number.

Do not power on cold-press terminals until they are properly connected or fully locked.

Failure to follow instructions specified by the manufacturer may result in serious consequences such as death, personal injury, or damage to equipment since the protection

provided by the equipment may be impaired.

AVERTISSEMENT

FONCTIONNEMENT INATTENDU DE L'EQUIPEMENT

Dépouillez la longueur de la couche isolante du fil plus de 10mm pour assurer la connexion fiable du signal.

Le conducteur doit utiliser le fil de cuivre et le noyau de fil est supérieur ou égal à 0,2 mm², inférieur ou égal à 1mm², afin d'assurer la connexion fiable du signal.

Lorsque les terminaux de presse à froid sont terminés, ils doivent être terminés et visualisés en stricte conformité avec les spécifications ou les exigences correspondantes et terminés selon le numéro de série de noeud correspondant.

Il est interdit d'activer les bornes à froid avant qu'elles ne soient correctement articulées ou complètement verrouillées.

Le fait de ne pas suivre les instructions peut entraîner une défaillance de la protection fournie par l'équipement, ce qui peut entraîner des conséquences graves, comme des blessures ou des dommages à l'équipement.

DANGER

FIRE DANGER

Use the correct wiring rules only for the maximum current capacity of the I/O channel and power supply.

Failure to follow instructions specified by the manufacturer may result in serious consequences such as death, personal injury, or damage to equipment since the protection provided by the equipment may be impaired.

WARNING

UNEXPECTED EQUIPMENT OPERATION

Do not exceed any of the ratings specified in the environmental and electrical characteristics table.

Failure to follow instructions specified by the manufacturer may result in serious consequences such as death, personal injury, or damage to equipment since the protection provided by the equipment may be impaired.

AVERTISSEMENT

FONCTIONNEMENT INATTENDU DE L'EQUIPEMENT

Ne dépassez aucune évaluation spécifiée dans le tableau de caractéristiques environnementales

et électriques..

Le fait de ne pas suivre les instructions peut entraîner une défaillance de la protection fournie par l'équipement, ce qui peut entraîner des conséquences graves, comme des blessures ou des dommages à l'équipement.

4 Wiring

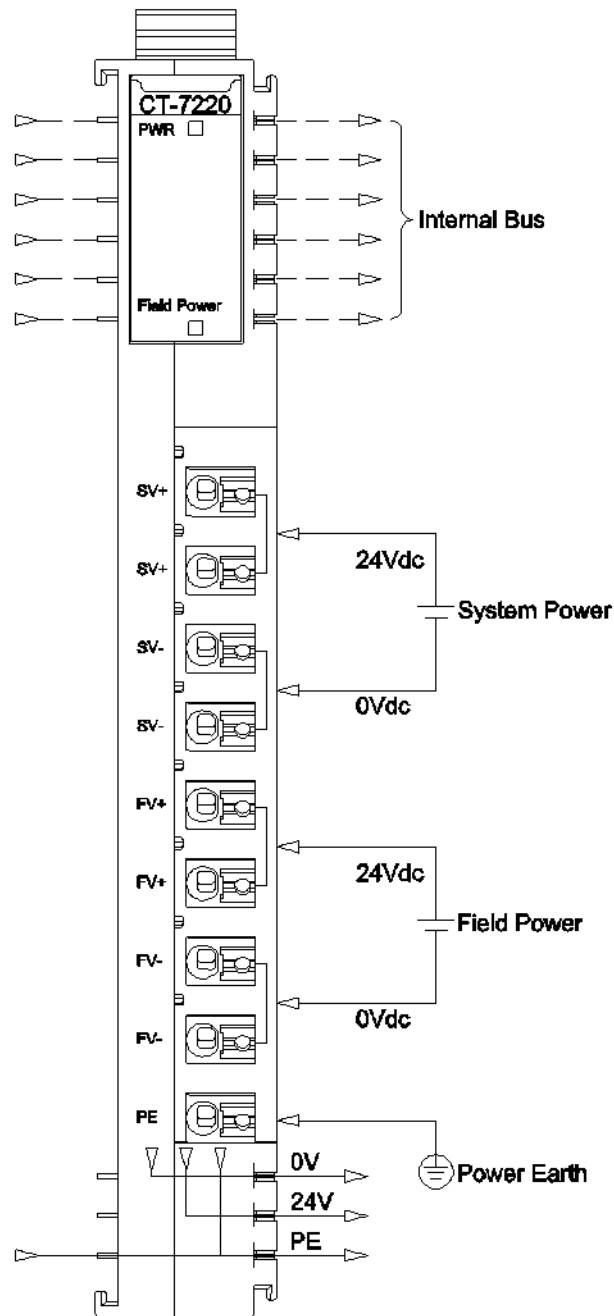

! WARNING

UNEXPECTED EQUIPMENT OPERATION

Inside the module, two terminals FV+ and two terminals FV- have been shorted. These four terminals must be independently and reliably connected to the onsite power supply.

Failure to follow instructions specified by the manufacturer may result in serious consequences such as death, personal injury, or damage to equipment since the protection provided by the equipment may be impaired.

AVERTISSEMENT

FONCTIONNEMENT INATTENDU DE L'EQUIPEMENT

À l'intérieur du module, les deux bornes FV+ sont connectées et les deux bornes FV- sont connectées. Ces quatre bornes doivent être connectées séparément et de manière fiable à l'alimentation sur site.

Le fait de ne pas suivre les instructions peut entraîner une défaillance de la protection fournie par l'équipement, ce qui peut entraîner des conséquences graves, comme des blessures ou des dommages à l'équipement.

NOTICE

EQUIPMENT INOPERABLE

Do not crimp the spring terminal with more than the maximum pressure specified for the terminal. Otherwise, the resilience of the spring terminal may be damaged and the terminal rebound may be affected.

Do not press the spring terminal with a sharp tool when removing cable from the channel. Otherwise, the spring terminal will be damaged.

Failure to follow these instructions may result in equipment damage.

5 Process data definition

No process data.

6 Configuration parameters definition

No configuration parameter.

A Dimension drawing

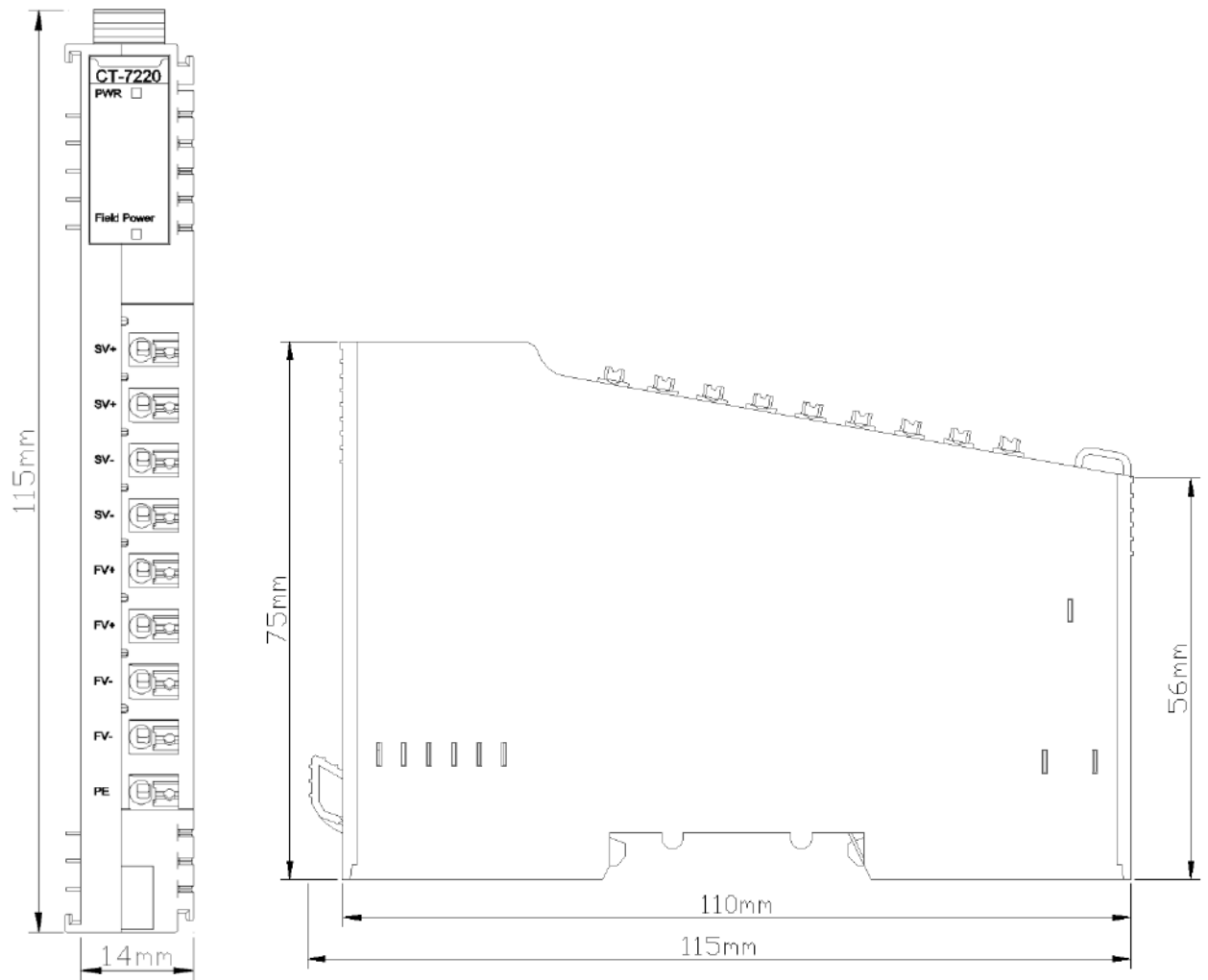

CT-7221 Power Supply Extension Module 5V/2A

1 Module features

- ◆ System Power and Field Power Extension
- ◆ System Power Output 2A@5VDC
- ◆ Field Power Extension 8A Current
- ◆ Requires configuration at IO config software

2 Technical Parameters

General Parameters	
System Power	Nominal: 24Vdc, Range: 20-30Vdc Current: Max.2A@24VDC Protection: overcurrent protection, anti-reverse connection protection
Module internal power consumption	20mA@5VDC
Internal Bus Supply Current	Max: 2.0A@5VDC
Isolation	System Power to Field Power Isolation
Field Power	Power Supply: 20.4~28.8V (Nominal: 24Vdc) Protection: anti-reverse connection protection
Field Power Supply Current	Max. DC 8A
Environment Specification	
Operating Temperature of Horizontal Installation	-35°C~70°C
Operating Temperature of Vertical Installation	-35°C~60°C
Relative Humidity	< 95%RH (No Condensation)
Storage Temperature	-40°C~85°C
Storage Humidity	< 95%RH (No Condensation)
Manufacturing Test Temperature	-40°C~75°C
Ingress Protection Rating	IP20

WARNING

UNEXPECTED EQUIPMENT OPERATION

Do not exceed any of the ratings specified in the environmental and electrical characteristics table.

Failure to follow instructions specified by the manufacturer may result in serious consequences such as death, personal injury, or damage to equipment since the protection provided by the equipment may be impaired.

AVERTISSEMENT

FONCTIONNEMENT INATTENDU DE L'EQUIPEMENT

Ne dépassez aucune évaluation spécifiée dans le tableau de caractéristiques environnementales et électriques..

Le fait de ne pas suivre les instructions peut entraîner une défaillance de la protection fournie par l'équipement, ce qui peut entraîner des conséquences graves, comme des

blesures ou des dommages à l'équipement.

3 Hardware Interface

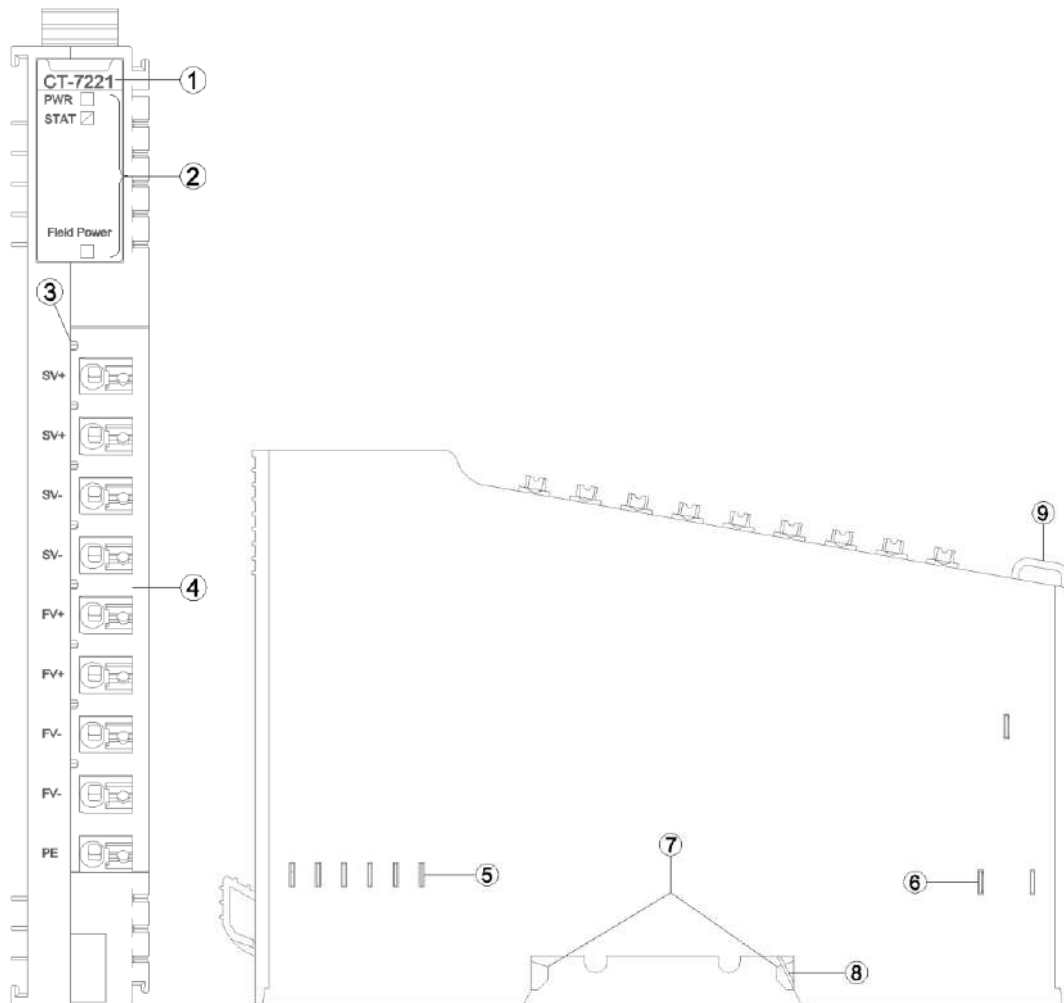

- ① Module Type
- ② State indicator
- ③ N/A
- ④ Wiring Terminal and identification
- ⑤ Internal Bus
- ⑥ Field Power
- ⑦ Buckle
- ⑧ Grounding Spring Sheet
- ⑨ Fixed Wiring Harness

3.1 LED indicator definition

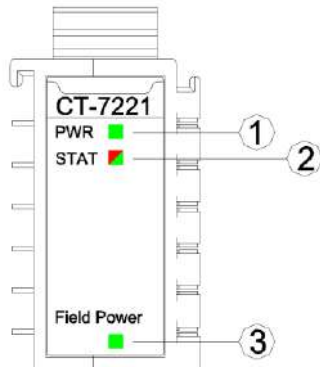

- ① System Power LED Indicator (green)
- ② Module State LED indicator (red/green)
- ③ Field Power LED Indicator (green)

PWR Power LED Indicator (GREEN)	Definition
ON	The system power supply is normal.
OFF	The system power supply is failure.
STAT Module State LED Indicator (Red/Green)	Definition
Green slow flash (2.5Hz)	Module internal bus is not started
Red slow flash (2.5Hz)	Module internal bus offline
ON (GREEN)	Operation normal
Flash(2.5Hz) (RED/GREEN)	Upgrading mode
Flash(10Hz) (RED/GREEN)	Firmware Update
Double Flash (RED)	Module Exception has been soft-restarted
Field Power LED Indicator (GREEN)	Definition
ON	The field power supply is normal.
OFF	The field power supply is failure.

! WARNING

UNEXPECTED EQUIPMENT OPERATION

By viewing the PW indicator, could determine the power supply status of a module. If the PW is steady green, the power supply is normal. Otherwise, the module cannot work properly.

When the module is initially powered on, there will be 3S for the backplane bus connection. After the backplane bus is initialized, STA is in the green steady state. If STA is in the green blinking state, it indicates that the backplane bus has not been initialized, and it needs to be powered off and restarted for re-initialization.

STA abnormal working state occurs during the normal operation of the module, please check the firmware version information of all modules, and consult ODOT technical support for details.

If a module is upgraded, check that all modules are in the normal state after the upgrade.

Otherwise, an exception may occur.

Failure to follow instructions specified by the manufacturer may result in serious consequences such as death, personal injury, or damage to equipment since the protection provided by the equipment may be impaired.

AVERTISSEMENT

FONCTIONNEMENT INATTENDU DE L'EQUIPEMENT

En regardant l'état de l'indicateur de PW, jugez l'état d'alimentation du module. Le feu vert PW reste allumé et l'alimentation est normale. Autrement, le module ne fonctionnera pas correctement.

Lorsque le module est alimenté initialement, il y aura 3S pour la connexion de bus de backboard. STA est un état vert permanent après l'initialisation du bus de backboard. Si STA est en état de clignotement vert, cela signifie que l'initialisation du bus de backboard n'est pas passée et doit être redémarrée hors tension et réinitialisée.

L'état de fonctionnement anormal de STA se produit pendant le fonctionnement normal du module, veuillez vérifier les informations de version du firmware de tous les modules, et consulter le support technique ODOT pour plus de détails.

Si le module a une opération de mise à niveau, après l'achèvement de la mise à niveau, le besoin de vérifier que tous les modules sont dans l'état normal avant de courir, sinon il conduira à une exception.

Le fait de ne pas suivre les instructions peut entraîner une défaillance de la protection fournie par l'équipement, ce qui peut entraîner des conséquences graves, comme des blessures ou des dommages à l'équipement.

3.2 Terminal definition

Terminal Number	Definition	Description
1	SV+	System Power Positive Pole
2	SV+	
3	SV-	System Power Negative Pole
4	SV-	
5	FV+	Field Power Positive Pole
6	FV+	
7	FV-	Field Power Negative Pole
8	FV-	
9	PE	System Grounded

When connecting a cold-pressed terminal, the terminal must be terminated and checked in strict accordance with the corresponding termination specifications or requirements, and connect the cold-pressed terminal according to the corresponding node serial number. The conductor should use copper conductor and the conductor core should be larger than 0.2mm² and smaller than 1mm² (AWG18~AWG24). Cold-pressed terminal parameters are as follows:

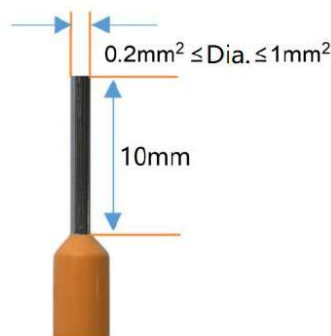

WARNING

UNEXPECTED EQUIPMENT OPERATION

Strip the length of the conductor insulation layer is greater than 10mm to ensure reliable signal connection.

The wire needs to use copper wire and the wire core is greater than or equal to 0.2mm² and less than or equal to 1mm² to ensure reliable signal connection.

When connecting a cold-press terminal, connect the cold-press terminal strictly in accordance with the corresponding termination specifications or requirements, and connect the cold-press terminal according to the corresponding node serial number.

Do not power on cold-press terminals until they are properly connected or fully locked.

Failure to follow instructions specified by the manufacturer may result in serious consequences such as death, personal injury, or damage to equipment since the protection

provided by the equipment may be impaired.

AVERTISSEMENT

FONCTIONNEMENT INATTENDU DE L'EQUIPEMENT

Dépouillez la longueur de la couche isolante du fil plus de 10mm pour assurer la connexion fiable du signal.

Le conducteur doit utiliser le fil de cuivre et le noyau de fil est supérieur ou égal à 0,2 mm², inférieur ou égal à 1mm², afin d'assurer la connexion fiable du signal.

Lorsque les terminaux de presse à froid sont terminés, ils doivent être terminés et visualisés en stricte conformité avec les spécifications ou les exigences correspondantes et terminés selon le numéro de série de noeud correspondant.

Il est interdit d'activer les bornes à froid avant qu'elles ne soient correctement articulées ou complètement verrouillées.

Le fait de ne pas suivre les instructions peut entraîner une défaillance de la protection fournie par l'équipement, ce qui peut entraîner des conséquences graves, comme des blessures ou des dommages à l'équipement.

DANGER

FIRE DANGER

Use the correct wiring rules only for the maximum current capacity of the I/O channel and power supply.

Failure to follow instructions specified by the manufacturer may result in serious consequences such as death, personal injury, or damage to equipment since the protection provided by the equipment may be impaired.

WARNING

UNEXPECTED EQUIPMENT OPERATION

Do not exceed any of the ratings specified in the environmental and electrical characteristics table.

Failure to follow instructions specified by the manufacturer may result in serious consequences such as death, personal injury, or damage to equipment since the protection provided by the equipment may be impaired.

AVERTISSEMENT

FONCTIONNEMENT INATTENDU DE L'EQUIPEMENT

Ne dépassez aucune évaluation spécifiée dans le tableau de caractéristiques environnementales

et électriques..

Le fait de ne pas suivre les instructions peut entraîner une défaillance de la protection fournie par l'équipement, ce qui peut entraîner des conséquences graves, comme des blessures ou des dommages à l'équipement.

4 Wiring

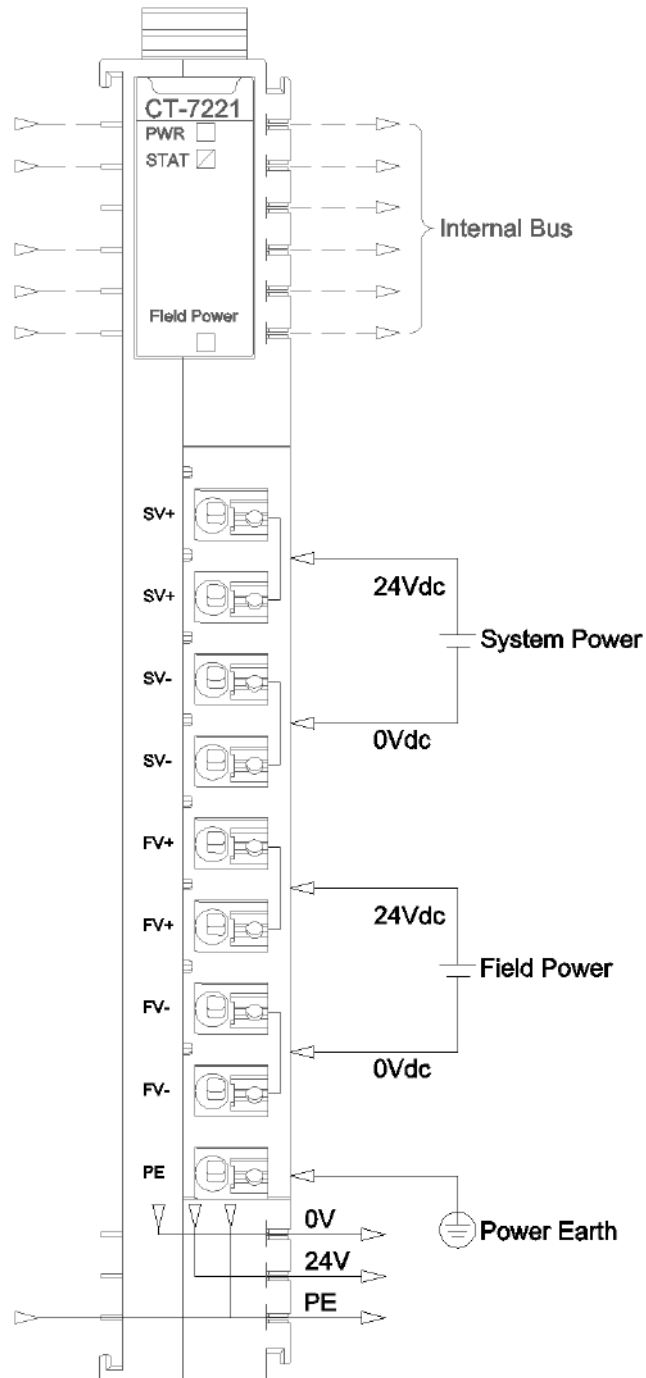

⚠ WARNING

UNEXPECTED EQUIPMENT OPERATION

Inside the module, two terminals FV+ and two terminals FV- have been shorted. These four terminals must be independently and reliably connected to the onsite power supply.

Failure to follow instructions specified by the manufacturer may result in serious consequences such as death, personal injury, or damage to equipment since the protection

provided by the equipment may be impaired.

AVERTISSEMENT

FONCTIONNEMENT INATTENDU DE L'EQUIPEMENT

À l'intérieur du module, les deux bornes FV+ sont connectées et les deux bornes FV- sont connectées. Ces quatre bornes doivent être connectées séparément et de manière fiable à l'alimentation sur site.

Le fait de ne pas suivre les instructions peut entraîner une défaillance de la protection fournie par l'équipement, ce qui peut entraîner des conséquences graves, comme des blessures ou des dommages à l'équipement.

NOTICE

EQUIPMENT INOPERABLE

Do not crimp the spring terminal with more than the maximum pressure specified for the terminal. Otherwise, the resilience of the spring terminal may be damaged and the terminal rebound may be affected.

Do not press the spring terminal with a sharp tool when removing cable from the channel. Otherwise, the spring terminal will be damaged.

Failure to follow these instructions may result in equipment damage.

5 Process data definition

No process data.

6 Configuration parameters definition

No configuration parameter.

A Dimension drawing

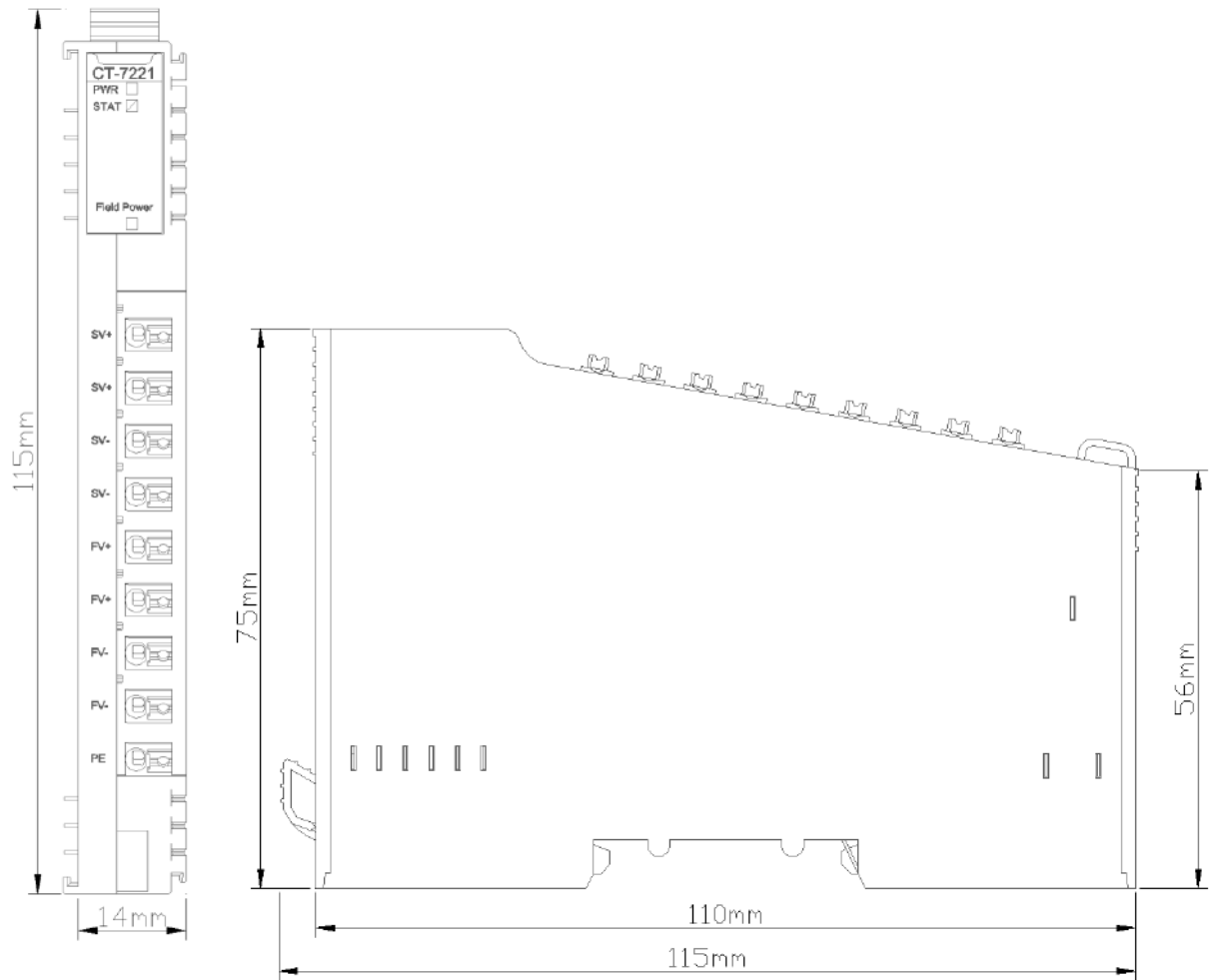

CT-730F 18 channels field power distribution module (0VDC)

1 Module features

- ◆ Support on-site power distribution, output is 0VDC.
- ◆ Support expansion of 18 channels.
- ◆ Requires no configuration and occupies no slot in configuration.

2 Technical Parameters

Environment Specification	
Operating Temperature of Horizontal Installation	-35°C~70°C
Operating Temperature of Vertical Installation	-35°C~60°C
Relative Humidity	< 95%RH (No Condensation)
Storage Temperature	-40°C~85°C
Storage Humidity	< 95%RH (No Condensation)
Manufacturing Test Temperature	-40°C~75°C
Ingress Protection Rating	IP20
Output Parameters	
Channel	18 channels 0VDC potential distribution output

WARNING

UNEXPECTED EQUIPMENT OPERATION

Do not exceed any of the ratings specified in the environmental and electrical characteristics table.

Failure to follow instructions specified by the manufacturer may result in serious consequences such as death, personal injury, or damage to equipment since the protection provided by the equipment may be impaired.

AVERTISSEMENT

FONCTIONNEMENT INATTENDU DE L'EQUIPEMENT

Ne dépassez aucune évaluation spécifiée dans le tableau de caractéristiques environnementales et électriques..

Le fait de ne pas suivre les instructions peut entraîner une défaillance de la protection fournie par l'équipement, ce qui peut entraîner des conséquences graves, comme des blessures ou des dommages à l'équipement.

3 Hardware Interface

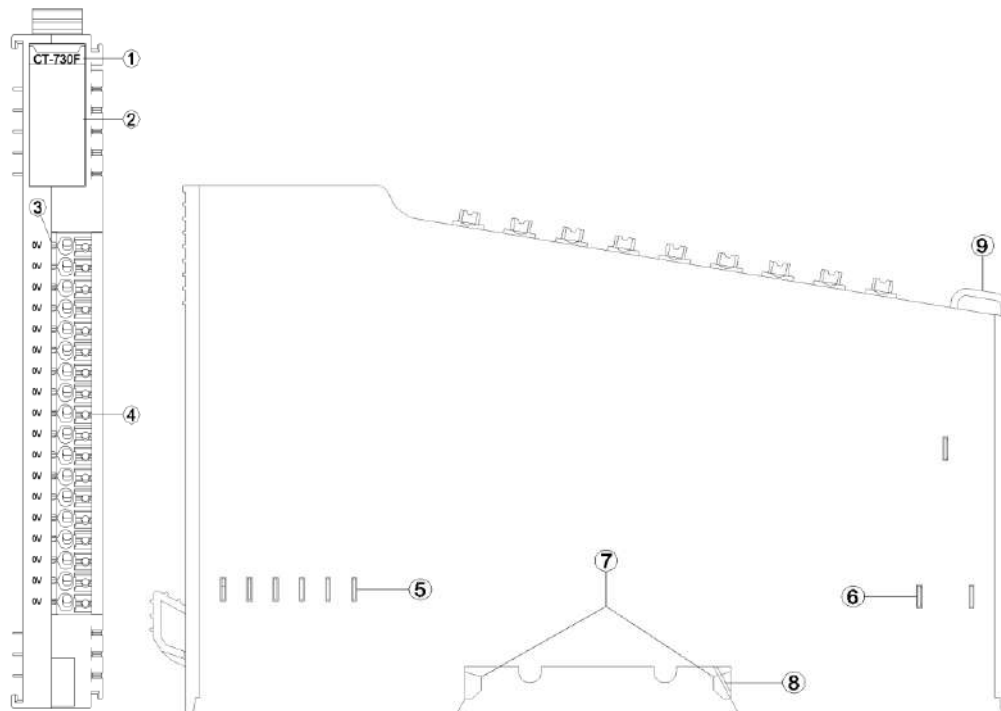

- ① Module Type
- ② N/A
- ③ N/A
- ④ Wiring Terminal and identification
- ⑤ Internal Bus
- ⑥ Field Power
- ⑦ Buckle
- ⑧ Grounding Spring Sheet
- ⑨ Fixed Wiring Harness

3.1 LED indicator definition

No indicator

3.2 Terminal definition

Terminal Number	Definition	Description
1	0V	0VDC output
2		
3		
4		
5		
6		
7		
8		
9		
10		
11		
12		
13		
14		
15		
16		
17		
18		

When connecting a cold-pressed terminal, the terminal must be terminated and checked in strict accordance with the corresponding termination specifications or requirements, and connect the cold-pressed terminal according to the corresponding node serial number. The conductor should use copper conductor and the conductor core should be larger than 0.2mm^2 and smaller than 1mm^2 (AWG18~AWG24). Cold-pressed terminal parameters are as follows:

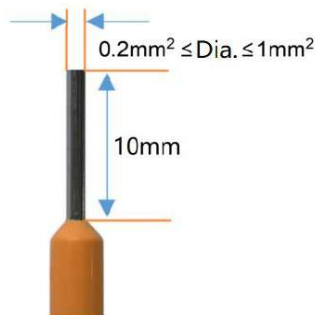

⚠	WARNING
UNEXPECTED EQUIPMENT OPERATION	

Strip the length of the conductor insulation layer is greater than 10mm to ensure reliable signal connection.

The wire needs to use copper wire and the wire core is greater than or equal to 0.2mm² and less than or equal to 1mm² to ensure reliable signal connection.

When connecting a cold-press terminal, connect the cold-press terminal strictly in accordance with the corresponding termination specifications or requirements, and connect the cold-press terminal according to the corresponding node serial number.

Do not power on cold-press terminals until they are properly connected or fully locked.

Failure to follow instructions specified by the manufacturer may result in serious consequences such as death, personal injury, or damage to equipment since the protection provided by the equipment may be impaired.

AVERTISSEMENT

FONCTIONNEMENT INATTENDU DE L'EQUIPEMENT

Dépouillez la longueur de la couche isolante du fil plus de 10mm pour assurer la connexion fiable du signal.

Le conducteur doit utiliser le fil de cuivre et le noyau de fil est supérieur ou égal à 0,2 mm², inférieur ou égal à 1mm², afin d'assurer la connexion fiable du signal.

Lorsque les terminaux de presse à froid sont terminés, ils doivent être terminés et visualisés en stricte conformité avec les spécifications ou les exigences correspondantes et terminés selon le numéro de série de noeud correspondant.

Il est interdit d'activer les bornes à froid avant qu'elles ne soient correctement articulées ou complètement verrouillées.

Le fait de ne pas suivre les instructions peut entraîner une défaillance de la protection fournie par l'équipement, ce qui peut entraîner des conséquences graves, comme des blessures ou des dommages à l'équipement.

DANGER

FIRE DANGER

Use the correct wiring rules only for the maximum current capacity of the I/O channel and power supply.

Failure to follow instructions specified by the manufacturer may result in serious consequences such as death, personal injury, or damage to equipment since the protection provided by the equipment may be impaired.

 **WARNING**

UNEXPECTED EQUIPMENT OPERATION

Do not exceed any of the ratings specified in the environmental and electrical characteristics table.

Failure to follow instructions specified by the manufacturer may result in serious consequences such as death, personal injury, or damage to equipment since the protection provided by the equipment may be impaired.

 **AVERTISSEMENT**

FONCTIONNEMENT INATTENDU DE L'EQUIPEMENT

Ne dépassez aucune évaluation spécifiée dans le tableau de caractéristiques environnementales et électriques..

Le fait de ne pas suivre les instructions peut entraîner une défaillance de la protection fournie par l'équipement, ce qui peut entraîner des conséquences graves, comme des blessures ou des dommages à l'équipement.

4 Wiring

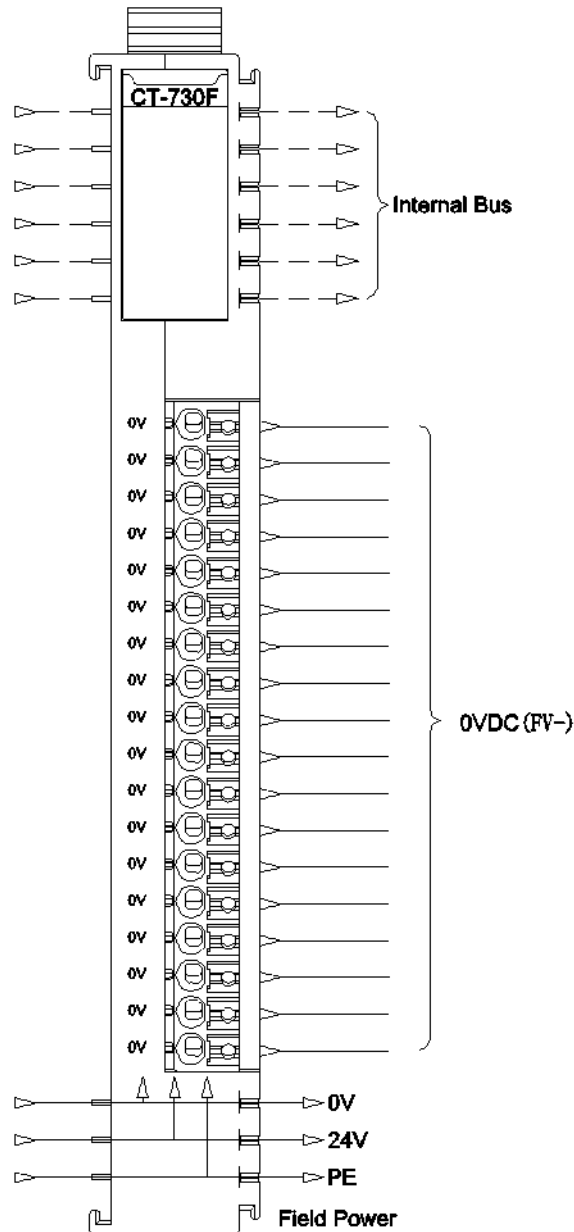

NOTICE

EQUIPMENT INOPERABLE

Do not crimp the spring terminal with more than the maximum pressure specified for the terminal. Otherwise, the resilience of the spring terminal may be damaged and the terminal rebound may be affected.

Do not press the spring terminal with a sharp tool when removing cable from the channel. Otherwise, the spring terminal will be damaged.

Failure to follow these instructions may result in equipment damage.

5 Process data definition

No process data.

6 Configuration parameters definition

No configuration parameter.

A Dimension drawing

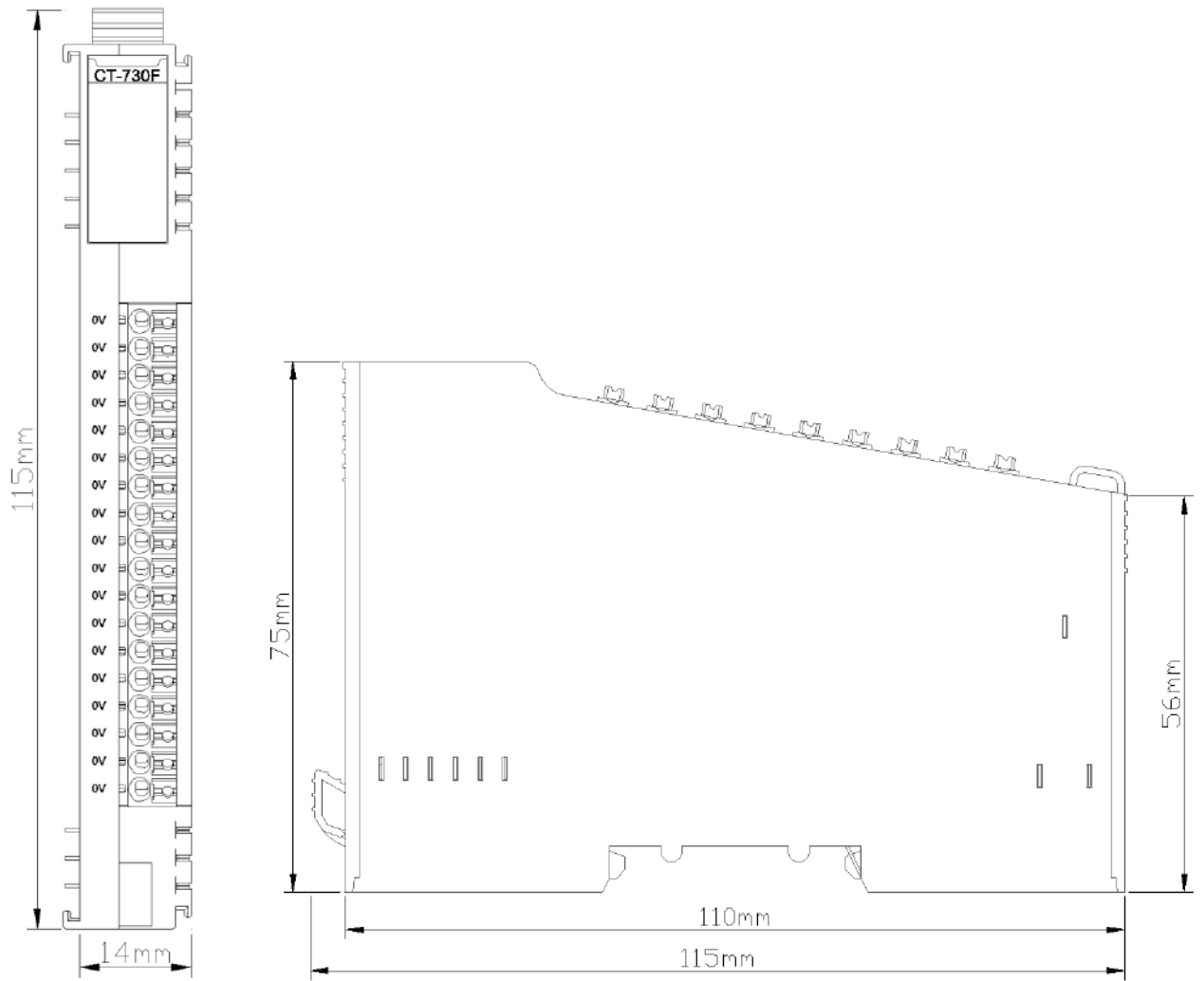

CT-731F 18 channels field power distribution module (24Vdc)

1 Module features

- ◆ Support on-site power distribution, output is 24VDC
- ◆ Support expansion of 18 channels
- ◆ Requires no configuration and occupies no slot in configuration.

2 Technical Parameters

Environment Specification	
Operating Temperature of Horizontal Installation	-35°C~70°C
Operating Temperature of Vertical Installation	-35°C~60°C
Relative Humidity	< 95%RH (No Condensation)
Storage Temperature	-40°C~85°C
Storage Humidity	< 95%RH (No Condensation)
Manufacturing Test Temperature	-40°C~75°C
Ingress Protection Rating	IP20
Output Parameters	
Channel	18 channels 24VDC potential distribution output

WARNING

UNEXPECTED EQUIPMENT OPERATION

Do not exceed any of the ratings specified in the environmental and electrical characteristics table.

Failure to follow instructions specified by the manufacturer may result in serious consequences such as death, personal injury, or damage to equipment since the protection provided by the equipment may be impaired.

AVERTISSEMENT

FONCTIONNEMENT INATTENDU DE L'EQUIPEMENT

Ne dépassez aucune évaluation spécifiée dans le tableau de caractéristiques environnementales et électriques..

Le fait de ne pas suivre les instructions peut entraîner une défaillance de la protection fournie par l'équipement, ce qui peut entraîner des conséquences graves, comme des blessures ou des dommages à l'équipement.

3 Hardware Interface

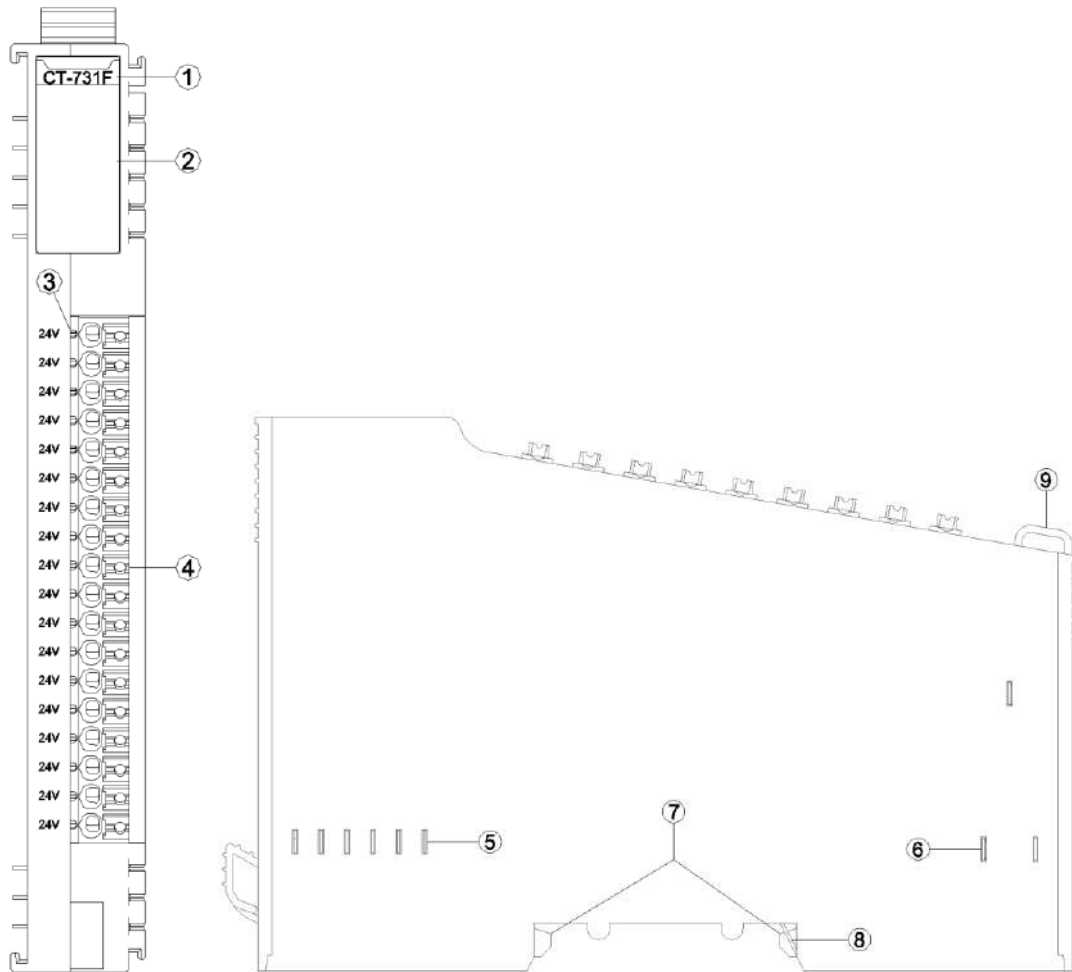

- ① Module Type
- ② N/A
- ③ N/A
- ④ Wiring Terminal and identification
- ⑤ Internal Bus
- ⑥ Field Power
- ⑦ Buckle
- ⑧ Grounding Spring Sheet
- ⑨ Fixed Wiring Harness

3.1 LED indictor definition

No Indicator

3.2 Terminal definition

Terminal Number	Definition	Description
1	24V	24VDC OUTPUT
2		
3		
4		
5		
6		
7		
8		
9		
10		
11		
12		
13		
14		
15		
16		
17		
18		

When connecting a cold-pressed terminal, the terminal must be terminated and checked in strict accordance with the corresponding termination specifications or requirements, and connect the cold-pressed terminal according to the corresponding node serial number. The conductor should use copper conductor and the conductor core should be larger than 0.2mm² and smaller than 1mm² (AWG18~AWG24). Cold-pressed terminal parameters are as follows:

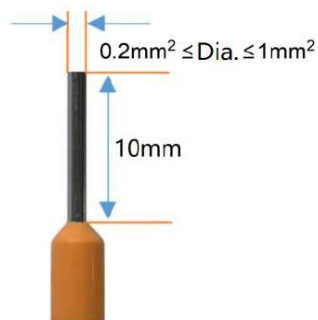

! WARNING

UNEXPECTED EQUIPMENT OPERATION

Strip the length of the conductor insulation layer is greater than 10mm to ensure reliable signal connection.

The wire needs to use copper wire and the wire core is greater than or equal to 0.2mm² and less than or equal to 1mm² to ensure reliable signal connection.

When connecting a cold-press terminal, connect the cold-press terminal strictly in accordance with the corresponding termination specifications or requirements, and connect the cold-press terminal according to the corresponding node serial number.

Do not power on cold-press terminals until they are properly connected or fully locked.

Failure to follow instructions specified by the manufacturer may result in serious consequences such as death, personal injury, or damage to equipment since the protection provided by the equipment may be impaired.

AVERTISSEMENT

FONCTIONNEMENT INATTENDU DE L'EQUIPEMENT

Dépouillez la longueur de la couche isolante du fil plus de 10mm pour assurer la connexion fiable du signal.

Le conducteur doit utiliser le fil de cuivre et le noyau de fil est supérieur ou égal à 0,2 mm², inférieur ou égal à 1mm², afin d'assurer la connexion fiable du signal.

Lorsque les terminaux de presse à froid sont terminés, ils doivent être terminés et visualisés en stricte conformité avec les spécifications ou les exigences correspondantes et terminés selon le numéro de série de noeud correspondant.

Il est interdit d'activer les bornes à froid avant qu'elles ne soient correctement articulées ou complètement verrouillées.

Le fait de ne pas suivre les instructions peut entraîner une défaillance de la protection fournie par l'équipement, ce qui peut entraîner des conséquences graves, comme des blessures ou des dommages à l'équipement.

DANGER

FIRE DANGER

Use the correct wiring rules only for the maximum current capacity of the I/O channel and power supply.

Failure to follow instructions specified by the manufacturer may result in serious consequences such as death, personal injury, or damage to equipment since the protection provided by the equipment may be impaired.

 **WARNING**

UNEXPECTED EQUIPMENT OPERATION

Do not exceed any of the ratings specified in the environmental and electrical characteristics table.

Failure to follow instructions specified by the manufacturer may result in serious consequences such as death, personal injury, or damage to equipment since the protection provided by the equipment may be impaired.

 **AVERTISSEMENT**

FONCTIONNEMENT INATTENDU DE L'EQUIPEMENT

Ne dépassez aucune évaluation spécifiée dans le tableau de caractéristiques environnementales et électriques..

Le fait de ne pas suivre les instructions peut entraîner une défaillance de la protection fournie par l'équipement, ce qui peut entraîner des conséquences graves, comme des blessures ou des dommages à l'équipement.

4 Wiring

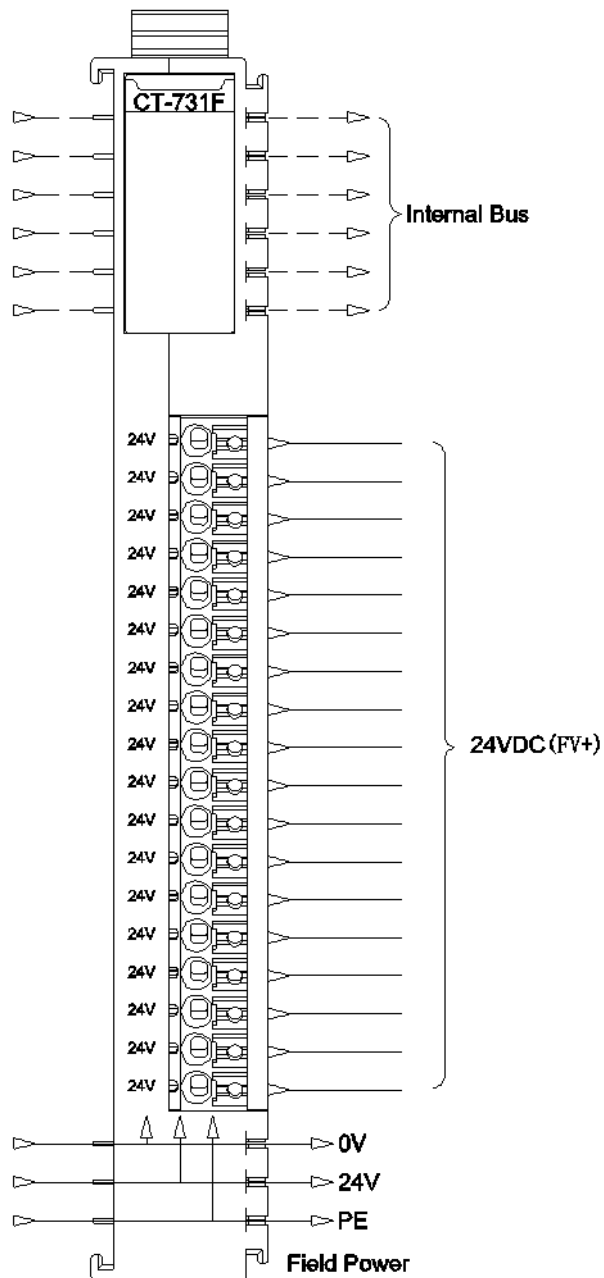

NOTICE

EQUIPMENT INOPERABLE

Do not crimp the spring terminal with more than the maximum pressure specified for the terminal. Otherwise, the resilience of the spring terminal may be damaged and the terminal rebound may be affected.

Do not press the spring terminal with a sharp tool when removing cable from the channel. Otherwise, the spring terminal will be damaged.

Failure to follow these instructions may result in equipment damage.

5 Process data definition

No process data.

6 Configuration parameters definition

No configuration parameter.

A Dimension drawing

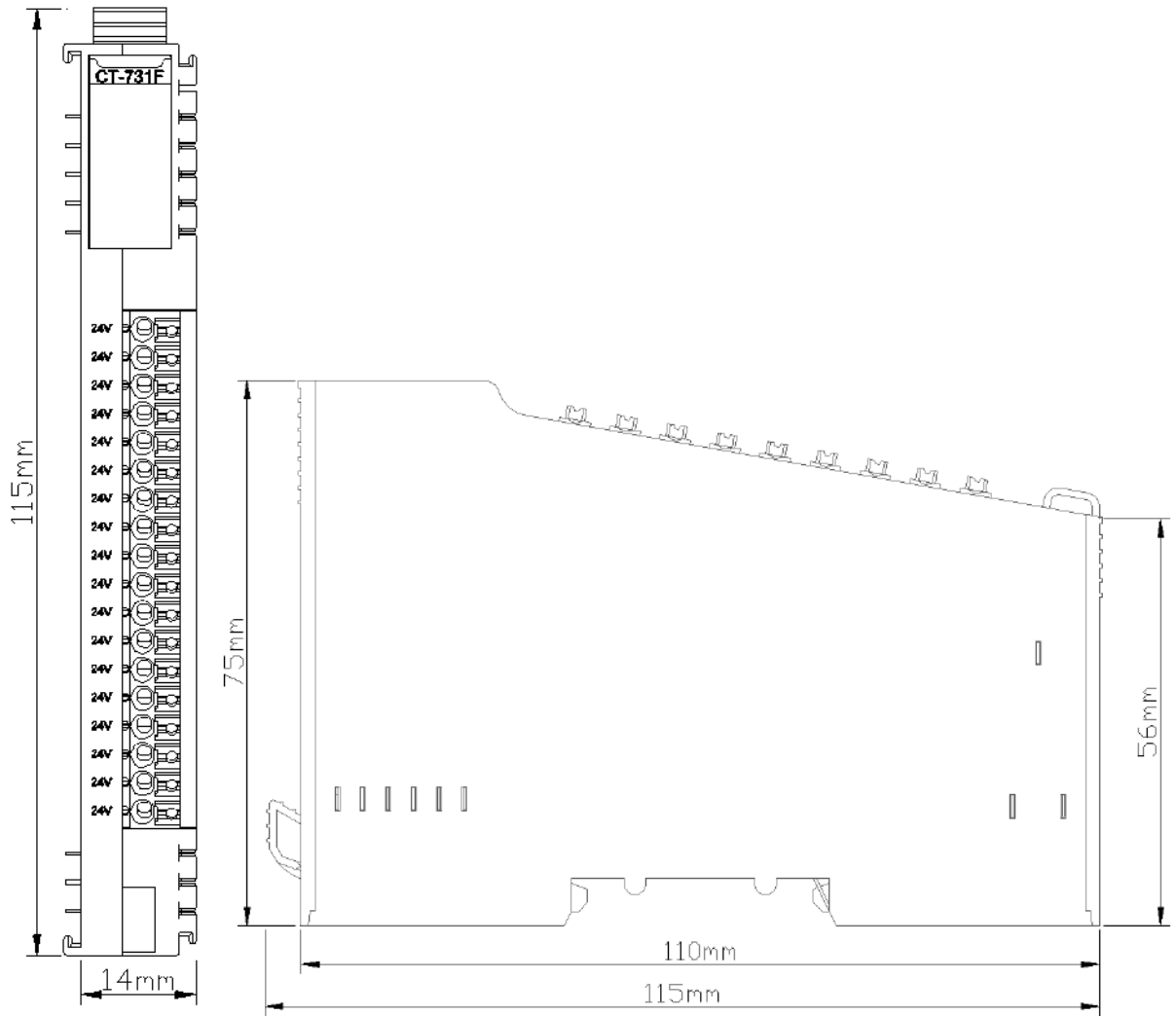

CT-732F 18 channels field power distribution module (PE)

1 Module features

- ◆ Support on-site power distribution, output is PE.
- ◆ Support expansion of 18 channels.
- ◆ Requires no configuration and occupies no slot in configuration.

2 Technical Parameters

Environment Specification	
Operating Temperature of Horizontal Installation	-35°C~70°C
Operating Temperature of Vertical Installation	-35°C~60°C
Relative Humidity	< 95%RH (No Condensation)
Storage Temperature	-40°C~85°C
Storage Humidity	< 95%RH (No Condensation)
Manufacturing Test Temperature	-40°C~75°C
Ingress Protection Rating	IP20
Output Parameters	
Channel	18-channel PE potential distribution output

WARNING

UNEXPECTED EQUIPMENT OPERATION

Do not exceed any of the ratings specified in the environmental and electrical characteristics table.

Failure to follow instructions specified by the manufacturer may result in serious consequences such as death, personal injury, or damage to equipment since the protection provided by the equipment may be impaired.

AVERTISSEMENT

FONCTIONNEMENT INATTENDU DE L'EQUIPEMENT

Ne dépassez aucune évaluation spécifiée dans le tableau de caractéristiques environnementales et électriques..

Le fait de ne pas suivre les instructions peut entraîner une défaillance de la protection fournie par l'équipement, ce qui peut entraîner des conséquences graves, comme des blessures ou des dommages à l'équipement.

3 Hardware Interface

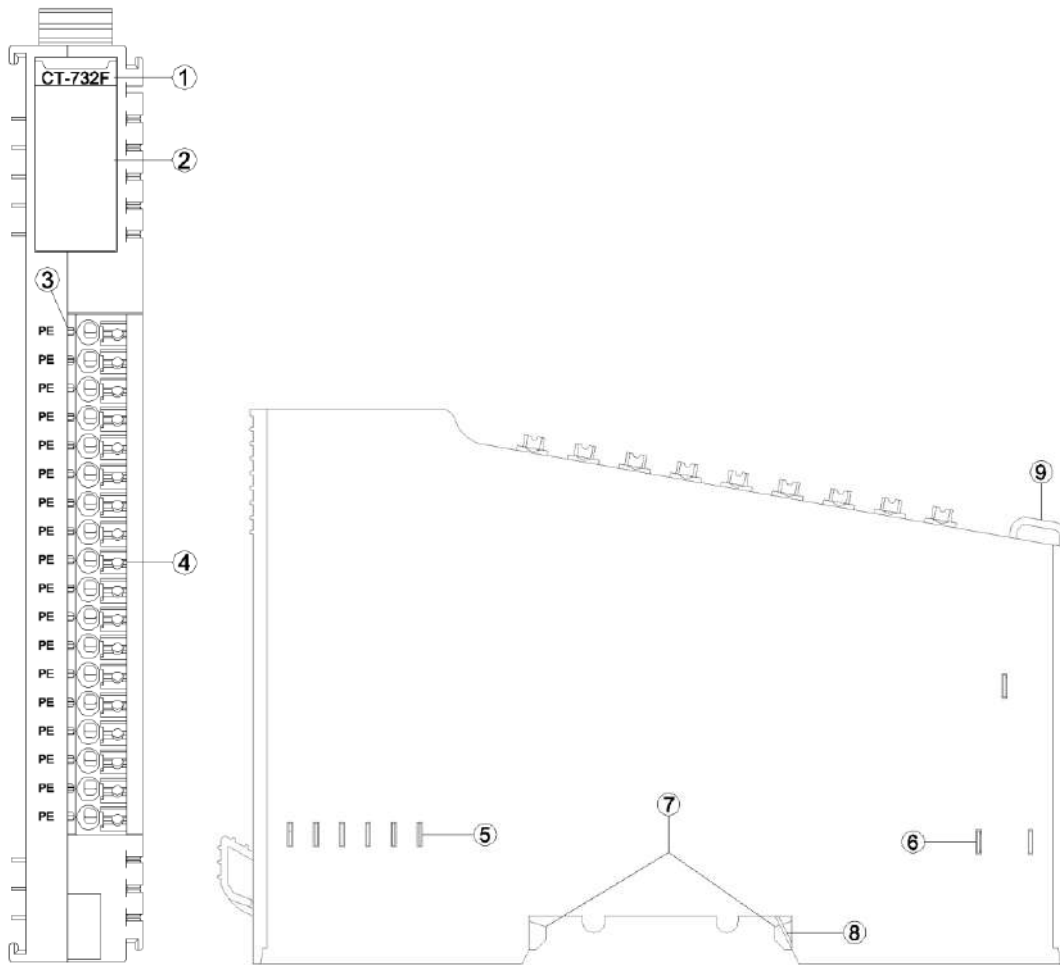

- ① Module Type
- ② N/A
- ③ N/A
- ④ Wiring Terminal and identification
- ⑤ Internal Bus
- ⑥ Field Power
- ⑦ Buckle
- ⑧ Grounding Spring Sheet
- ⑨ Fixed Wiring Harness

3.1 LED indicator definition

No Indicator

3.2 Terminal definition

Terminal Number	Definition	Description
1	PE	PE output
2		
3		
4		
5		
6		
7		
8		
9		
10		
11		
12		
13		
14		
15		
16		
17		
18		

When connecting a cold-pressed terminal, the terminal must be terminated and checked in strict accordance with the corresponding termination specifications or requirements, and connect the cold-pressed terminal according to the corresponding node serial number. The conductor should use copper conductor and the conductor core should be larger than 0.2mm^2 and smaller than 1mm^2 (AWG18~AWG24). Cold-pressed terminal parameters are as follows:

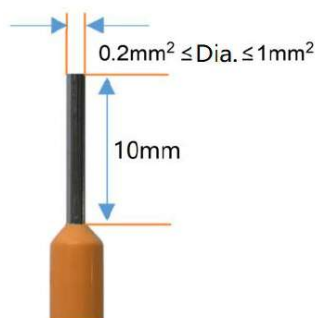

WARNING

UNEXPECTED EQUIPMENT OPERATION

Strip the length of the conductor insulation layer is greater than 10mm to ensure reliable signal connection.

The wire needs to use copper wire and the wire core is greater than or equal to 0.2mm² and less than or equal to 1mm² to ensure reliable signal connection.

When connecting a cold-press terminal, connect the cold-press terminal strictly in accordance with the corresponding termination specifications or requirements, and connect the cold-press terminal according to the corresponding node serial number.

Do not power on cold-press terminals until they are properly connected or fully locked.

Failure to follow instructions specified by the manufacturer may result in serious consequences such as death, personal injury, or damage to equipment since the protection provided by the equipment may be impaired.

AVERTISSEMENT

FONCTIONNEMENT INATTENDU DE L'EQUIPEMENT

Dépouillez la longueur de la couche isolante du fil plus de 10mm pour assurer la connexion fiable du signal.

Le conducteur doit utiliser le fil de cuivre et le noyau de fil est supérieur ou égal à 0,2 mm², inférieur ou égal à 1mm², afin d'assurer la connexion fiable du signal.

Lorsque les terminaux de presse à froid sont terminés, ils doivent être terminés et visualisés en stricte conformité avec les spécifications ou les exigences correspondantes et terminés selon le numéro de série de noeud correspondant.

Il est interdit d'activer les bornes à froid avant qu'elles ne soient correctement articulées ou complètement verrouillées.

Le fait de ne pas suivre les instructions peut entraîner une défaillance de la protection fournie par l'équipement, ce qui peut entraîner des conséquences graves, comme des blessures ou des dommages à l'équipement.

DANGER

FIRE DANGER

Use the correct wiring rules only for the maximum current capacity of the I/O channel and power supply.

Failure to follow instructions specified by the manufacturer may result in serious consequences such as death, personal injury, or damage to equipment since the protection provided by the equipment may be impaired.

 **WARNING**

UNEXPECTED EQUIPMENT OPERATION

Do not exceed any of the ratings specified in the environmental and electrical characteristics table.

Failure to follow instructions specified by the manufacturer may result in serious consequences such as death, personal injury, or damage to equipment since the protection provided by the equipment may be impaired.

 **AVERTISSEMENT**

FONCTIONNEMENT INATTENDU DE L'EQUIPEMENT

Ne dépassez aucune évaluation spécifiée dans le tableau de caractéristiques environnementales et électriques..

Le fait de ne pas suivre les instructions peut entraîner une défaillance de la protection fournie par l'équipement, ce qui peut entraîner des conséquences graves, comme des blessures ou des dommages à l'équipement.

4 Wiring

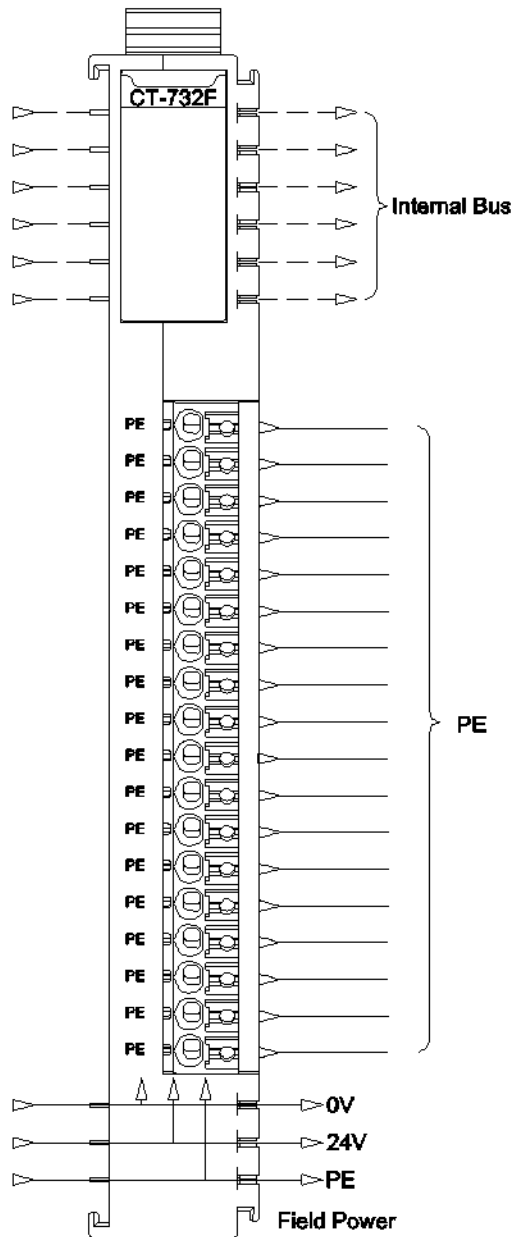

NOTICE

EQUIPMENT INOPERABLE

Do not crimp the spring terminal with more than the maximum pressure specified for the terminal. Otherwise, the resilience of the spring terminal may be damaged and the terminal rebound may be affected.

Do not press the spring terminal with a sharp tool when removing cable from the channel. Otherwise, the spring terminal will be damaged.

Failure to follow these instructions may result in equipment damage.

5 Process data definition

No process data.

6 Configuration parameters definition

No configuration parameter.

A Dimension drawing

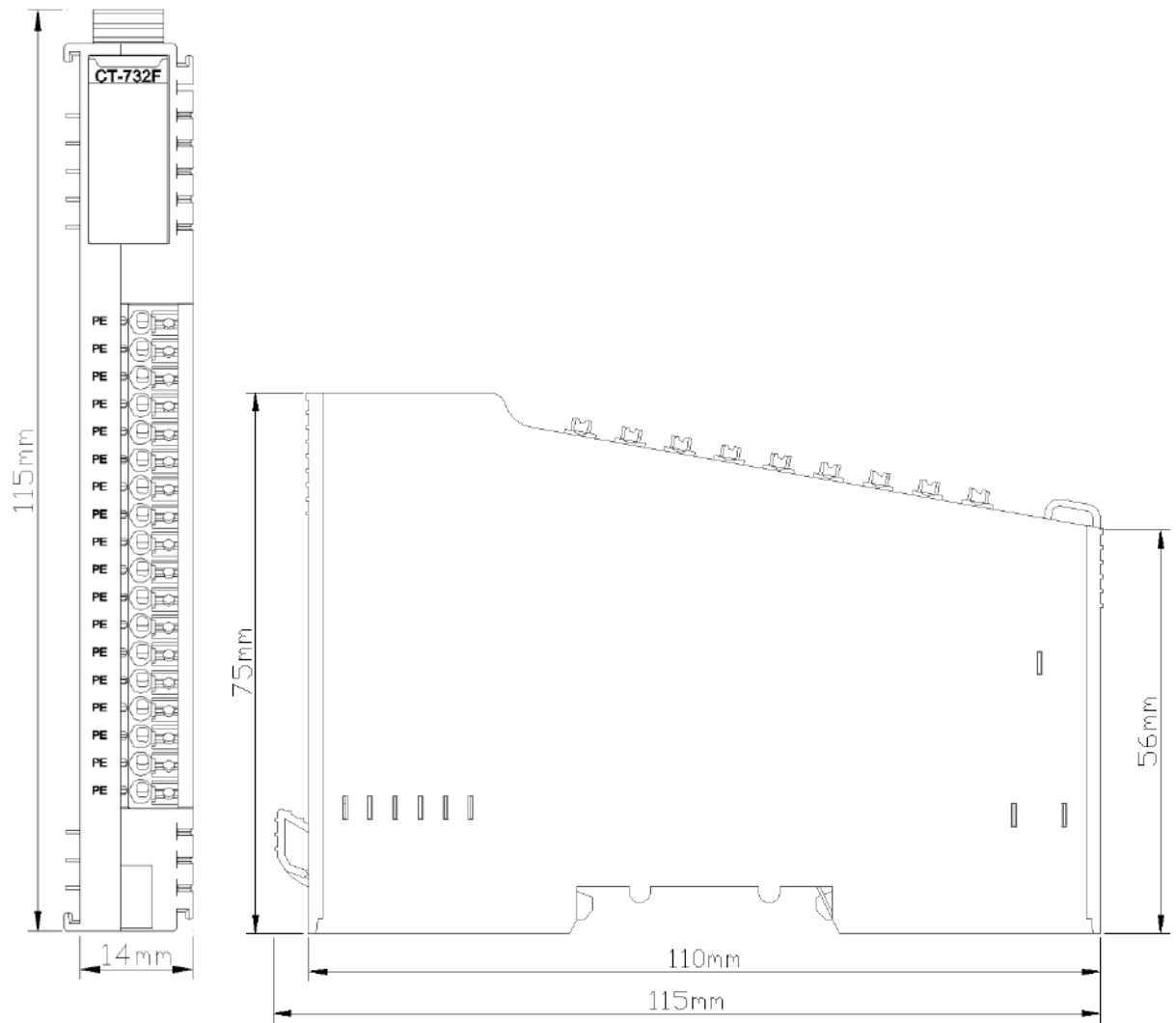

CT-7339 18 channels field power distribution module (24VDC/0VDC)

1 Module features

- ◆ Support on-site power distribution, output is 24VDC/0VDC
- ◆ Support expansion of 18 channels ,9 channels of 24VDC ,9 channels of 0VDC.
- ◆ Requires no configuration and occupies no slot in configuration.

2 Technical Parameters

Environment Specification	
Operating Temperature of Horizontal Installation	-35°C~70°C
Operating Temperature of Vertical Installation	-35°C~60°C
Relative Humidity	< 95%RH (No Condensation)
Storage Temperature	-40°C~85°C
Storage Humidity	< 95%RH (No Condensation)
Manufacturing Test Temperature	-40°C~75°C
Ingress Protection Rating	IP20
Output Parameters	
Channel	9 channels 24VDC potential distribution output 9 channels 0VDC potential distribution output

WARNING

UNEXPECTED EQUIPMENT OPERATION

Do not exceed any of the ratings specified in the environmental and electrical characteristics table.

Failure to follow instructions specified by the manufacturer may result in serious consequences such as death, personal injury, or damage to equipment since the protection provided by the equipment may be impaired.

AVERTISSEMENT

FONCTIONNEMENT INATTENDU DE L'EQUIPEMENT

Ne dépassez aucune évaluation spécifiée dans le tableau de caractéristiques environnementales et électriques..

Le fait de ne pas suivre les instructions peut entraîner une défaillance de la protection fournie par l'équipement, ce qui peut entraîner des conséquences graves, comme des blessures ou des dommages à l'équipement.

3 Hardware Interface

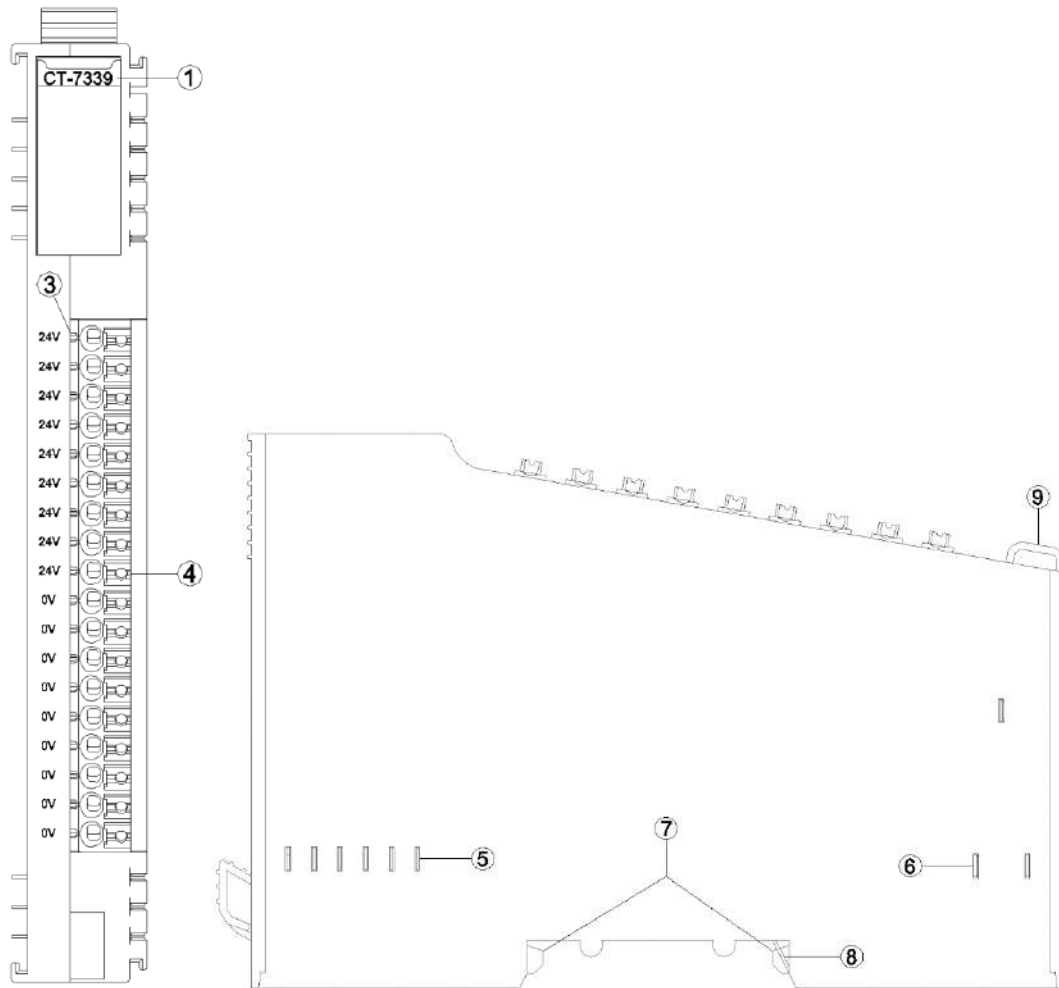

- ① Module Type
- ② N/A
- ③ N/A
- ④ Wiring Terminal and identification
- ⑤ Internal Bus
- ⑥ Field Power
- ⑦ Buckle
- ⑧ Grounding Spring Sheet
- ⑨ Fixed Wiring Harness

3.1 LED indicator definition

NO indicator

3.2 Terminal definition

Terminal Number	Definition	Specification
1	24Vdc	24Vdc output
2		
3		
4		
5		
6		
7		
8		
9		
10	0Vdc	0Vdc output
11		
12		
13		
14		
15		
16		
17		
18		

When connecting a cold-pressed terminal, the terminal must be terminated and checked in strict accordance with the corresponding termination specifications or requirements, and connect the cold-pressed terminal according to the corresponding node serial number. The conductor should use copper conductor and the conductor core should be larger than 0.2mm^2 and smaller than 1mm^2 (AWG18~AWG24). Cold-pressed terminal parameters are as follows:

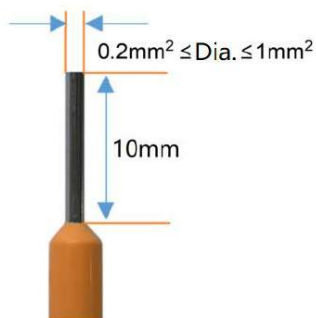

WARNING

UNEXPECTED EQUIPMENT OPERATION

Strip the length of the conductor insulation layer is greater than 10mm to ensure reliable signal connection.

The wire needs to use copper wire and the wire core is greater than or equal to 0.2mm² and less than or equal to 1mm² to ensure reliable signal connection.

When connecting a cold-press terminal, connect the cold-press terminal strictly in accordance with the corresponding termination specifications or requirements, and connect the cold-press terminal according to the corresponding node serial number.

Do not power on cold-press terminals until they are properly connected or fully locked.

Failure to follow instructions specified by the manufacturer may result in serious consequences such as death, personal injury, or damage to equipment since the protection provided by the equipment may be impaired.

AVERTISSEMENT

FONCTIONNEMENT INATTENDU DE L'EQUIPEMENT

Dépouillez la longueur de la couche isolante du fil plus de 10mm pour assurer la connexion fiable du signal.

Le conducteur doit utiliser le fil de cuivre et le noyau de fil est supérieur ou égal à 0,2 mm², inférieur ou égal à 1mm², afin d'assurer la connexion fiable du signal.

Lorsque les terminaux de presse à froid sont terminés, ils doivent être terminés et visualisés en stricte conformité avec les spécifications ou les exigences correspondantes et terminés selon le numéro de série de noeud correspondant.

Il est interdit d'activer les bornes à froid avant qu'elles ne soient correctement articulées ou complètement verrouillées.

Le fait de ne pas suivre les instructions peut entraîner une défaillance de la protection fournie par l'équipement, ce qui peut entraîner des conséquences graves, comme des blessures ou des dommages à l'équipement.

DANGER

FIRE DANGER

Use the correct wiring rules only for the maximum current capacity of the I/O channel and power supply.

Failure to follow instructions specified by the manufacturer may result in serious consequences such as death, personal injury, or damage to equipment since the protection provided by the equipment may be impaired.

 **WARNING**

UNEXPECTED EQUIPMENT OPERATION

Do not exceed any of the ratings specified in the environmental and electrical characteristics table.

Failure to follow instructions specified by the manufacturer may result in serious consequences such as death, personal injury, or damage to equipment since the protection provided by the equipment may be impaired.

 **AVERTISSEMENT**

FONCTIONNEMENT INATTENDU DE L'EQUIPEMENT

Ne dépassez aucune évaluation spécifiée dans le tableau de caractéristiques environnementales et électriques..

Le fait de ne pas suivre les instructions peut entraîner une défaillance de la protection fournie par l'équipement, ce qui peut entraîner des conséquences graves, comme des blessures ou des dommages à l'équipement.

4 Wiring

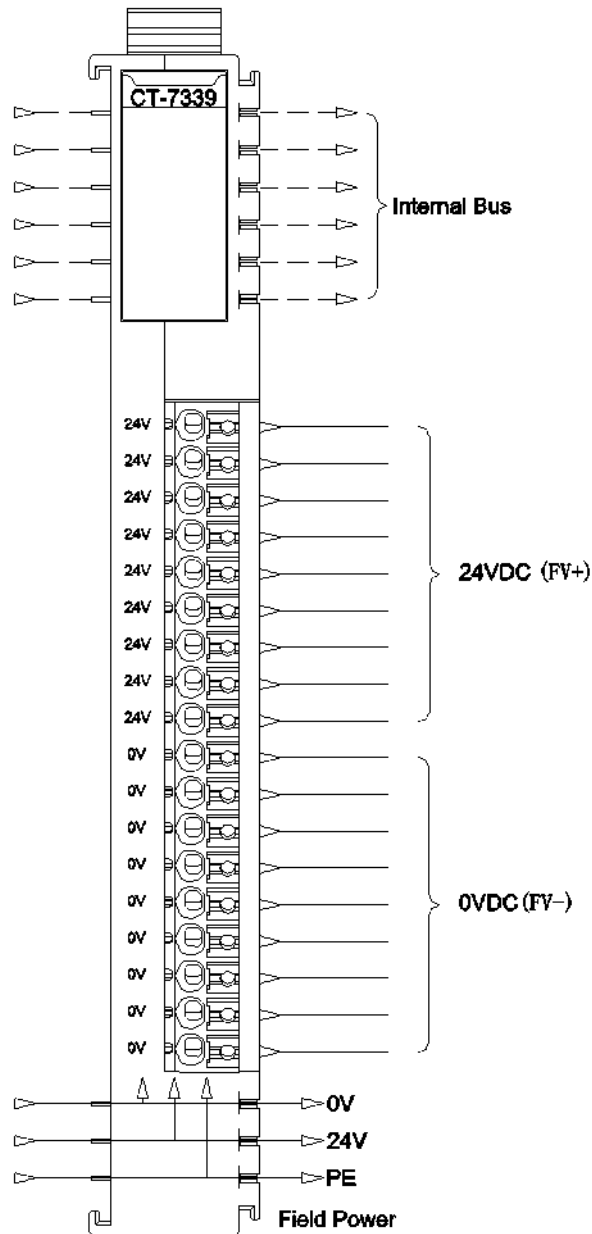

NOTICE

EQUIPMENT INOPERABLE

Do not crimp the spring terminal with more than the maximum pressure specified for the terminal. Otherwise, the resilience of the spring terminal may be damaged and the terminal rebound may be affected.

Do not press the spring terminal with a sharp tool when removing cable from the channel. Otherwise, the spring terminal will be damaged.

Failure to follow these instructions may result in equipment damage.

5 Process data definition

No process data.

6 Configuration parameters definition

No configuration parameter.

A Dimension drawing

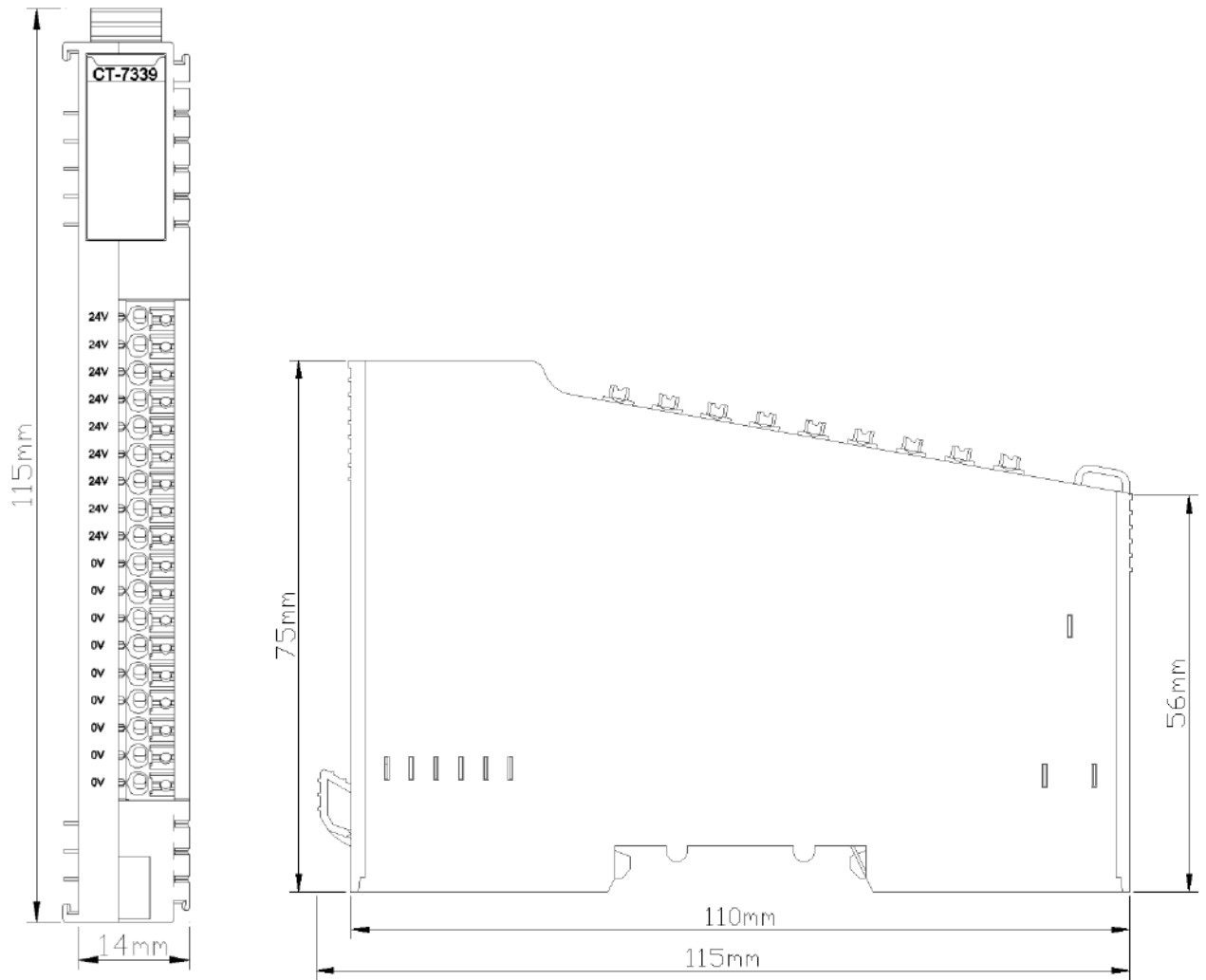

CT-7346 18 channels field power distribution module (24VDC/0VDC/PE)

1 Module features

- ◆ Support on-site power distribution, output is 24VDC/0VDC.
- ◆ Support expansion of 18 channels ,6 channels of 24VDC ,6 channels of 0VDC ,6 channels of PE.
- ◆ Requires no configuration and occupies no slot in configuration.

2 Technical Parameters

Environment Specification	
Operating Temperature of Horizontal Installation	-35°C~70°C
Operating Temperature of Vertical Installation	-35°C~60°C
Relative Humidity	< 95%RH (No Condensation)
Storage Temperature	-40°C~85°C
Storage Humidity	< 95%RH (No Condensation)
Manufacturing Test Temperature	-40°C~75°C
Ingress Protection Rating	IP20
Output Parameters	
Channel	6 channels 24VDC potential distribution output 6 channels 0VDC potential distribution output 6 channels PE potential distribution output

WARNING

UNEXPECTED EQUIPMENT OPERATION

Do not exceed any of the ratings specified in the environmental and electrical characteristics table.

Failure to follow instructions specified by the manufacturer may result in serious consequences such as death, personal injury, or damage to equipment since the protection provided by the equipment may be impaired.

AVERTISSEMENT

FONCTIONNEMENT INATTENDU DE L'EQUIPEMENT

Ne dépassez aucune évaluation spécifiée dans le tableau de caractéristiques environnementales et électriques..

Le fait de ne pas suivre les instructions peut entraîner une défaillance de la protection fournie par l'équipement, ce qui peut entraîner des conséquences graves, comme des blessures ou des dommages à l'équipement.

3 Hardware Interface

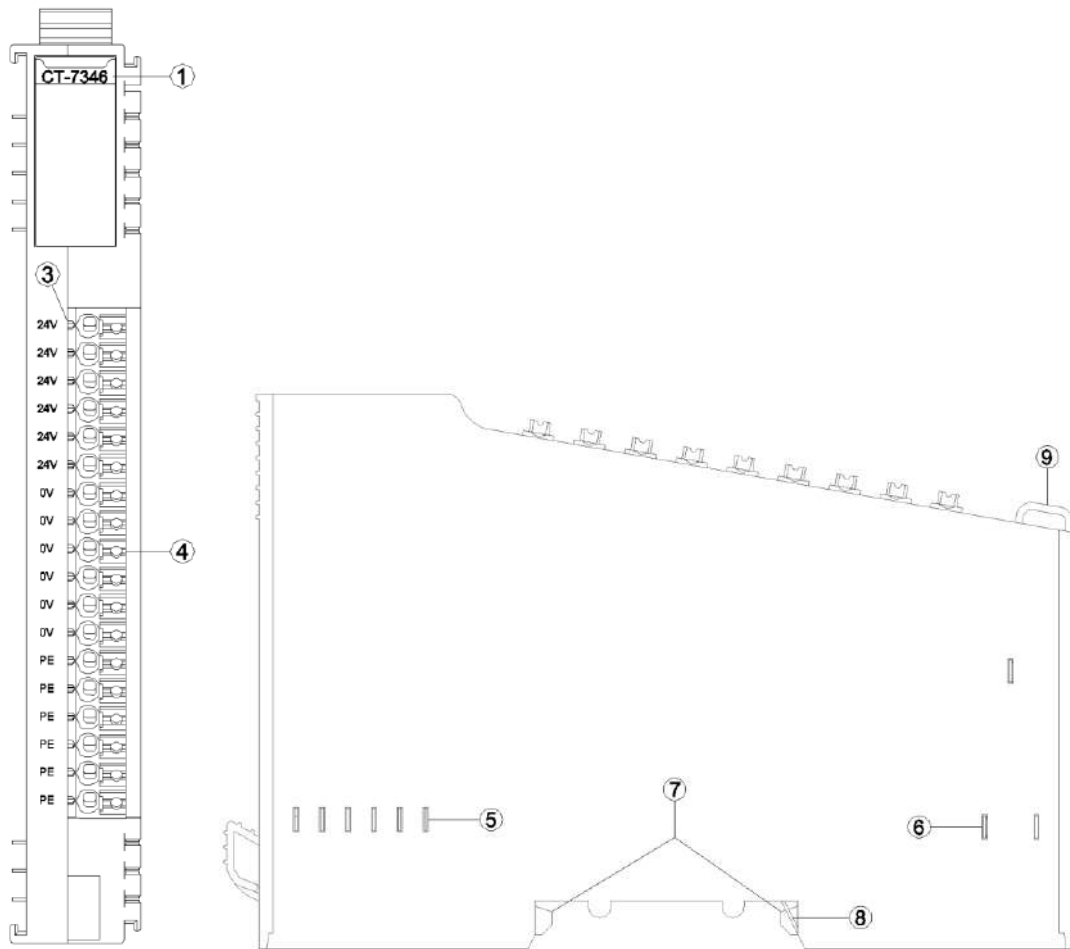

- ① Module Type
- ② N/A
- ③ N/A
- ④ Wiring Terminal and identification
- ⑤ Internal Bus
- ⑥ Field Power
- ⑦ Buckle
- ⑧ Grounding Spring Sheet
- ⑨ Fixed Wiring Harness

3.1 LED indicator definition

No indicator

3.2 Terminal definition

Terminal Number	definition	Specification
1	24Vdc	24Vdc output
2		
3		
4		
5		
6		
7	0Vdc	0Vdc output
8		
9		
10		
11		
12		
13	PE	PE output
14		
15		
16		
17		
18		

When connecting a cold-pressed terminal, the terminal must be terminated and checked in strict accordance with the corresponding termination specifications or requirements, and connect the cold-pressed terminal according to the corresponding node serial number. The conductor should use copper conductor and the conductor core should be larger than 0.2mm^2 and smaller than 1mm^2 (AWG18~AWG24). Cold-pressed terminal parameters are as follows:

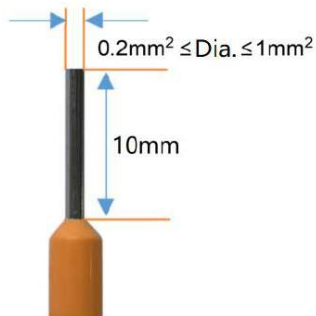

WARNING

UNEXPECTED EQUIPMENT OPERATION

Strip the length of the conductor insulation layer is greater than 10mm to ensure reliable signal connection.

The wire needs to use copper wire and the wire core is greater than or equal to 0.2mm² and less than or equal to 1mm² to ensure reliable signal connection.

When connecting a cold-press terminal, connect the cold-press terminal strictly in accordance with the corresponding termination specifications or requirements, and connect the cold-press terminal according to the corresponding node serial number.

Do not power on cold-press terminals until they are properly connected or fully locked.

Failure to follow instructions specified by the manufacturer may result in serious consequences such as death, personal injury, or damage to equipment since the protection provided by the equipment may be impaired.

AVERTISSEMENT

FONCTIONNEMENT INATTENDU DE L'EQUIPEMENT

Dépouillez la longueur de la couche isolante du fil plus de 10mm pour assurer la connexion fiable du signal.

Le conducteur doit utiliser le fil de cuivre et le noyau de fil est supérieur ou égal à 0,2 mm², inférieur ou égal à 1mm², afin d'assurer la connexion fiable du signal.

Lorsque les terminaux de presse à froid sont terminés, ils doivent être terminés et visualisés en stricte conformité avec les spécifications ou les exigences correspondantes et terminés selon le numéro de série de noeud correspondant.

Il est interdit d'activer les bornes à froid avant qu'elles ne soient correctement articulées ou complètement verrouillées.

Le fait de ne pas suivre les instructions peut entraîner une défaillance de la protection fournie par l'équipement, ce qui peut entraîner des conséquences graves, comme des blessures ou des dommages à l'équipement.

DANGER

FIRE DANGER

Use the correct wiring rules only for the maximum current capacity of the I/O channel and power supply.

Failure to follow instructions specified by the manufacturer may result in serious consequences such as death, personal injury, or damage to equipment since the protection provided by the equipment may be impaired.

 **WARNING**

UNEXPECTED EQUIPMENT OPERATION

Do not exceed any of the ratings specified in the environmental and electrical characteristics table.

Failure to follow instructions specified by the manufacturer may result in serious consequences such as death, personal injury, or damage to equipment since the protection provided by the equipment may be impaired.

 **AVERTISSEMENT**

FONCTIONNEMENT INATTENDU DE L'EQUIPEMENT

Ne dépassez aucune évaluation spécifiée dans le tableau de caractéristiques environnementales et électriques..

Le fait de ne pas suivre les instructions peut entraîner une défaillance de la protection fournie par l'équipement, ce qui peut entraîner des conséquences graves, comme des blessures ou des dommages à l'équipement.

4 Wiring

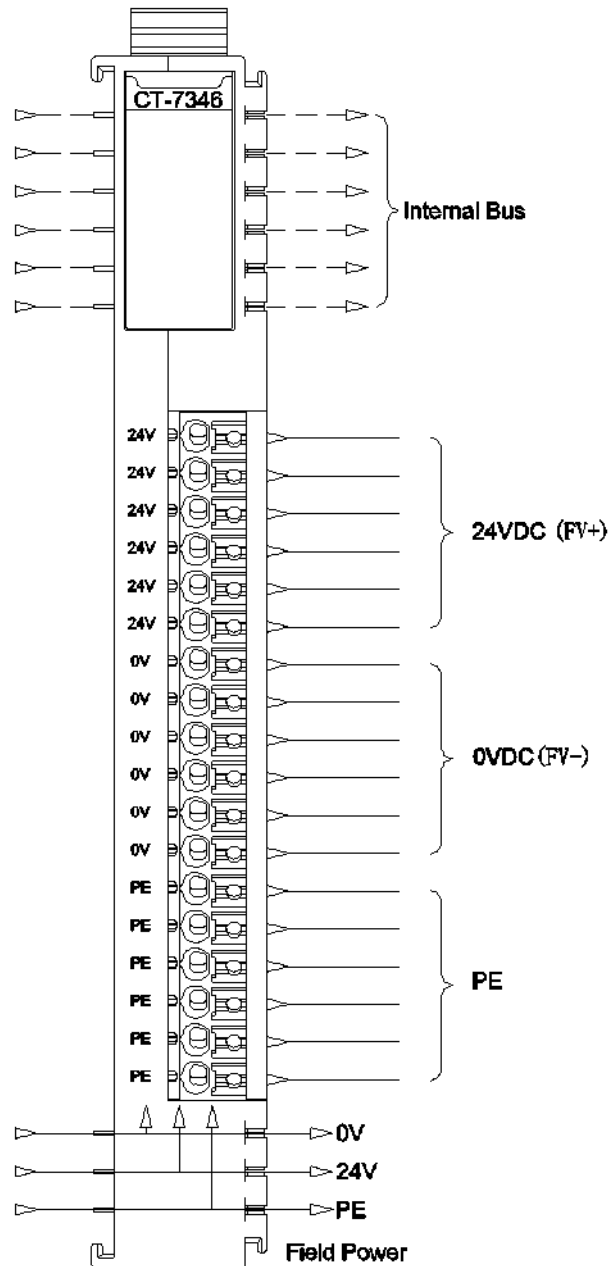

NOTICE

EQUIPMENT INOPERABLE

Do not crimp the spring terminal with more than the maximum pressure specified for the terminal. Otherwise, the resilience of the spring terminal may be damaged and the terminal rebound may be affected.

Do not press the spring terminal with a sharp tool when removing cable from the channel. Otherwise, the spring terminal will be damaged.

Failure to follow these instructions may result in equipment damage.

5 Process data definition

No process data.

6 Configuration parameters definition

No configuration parameter.

A Dimension drawing

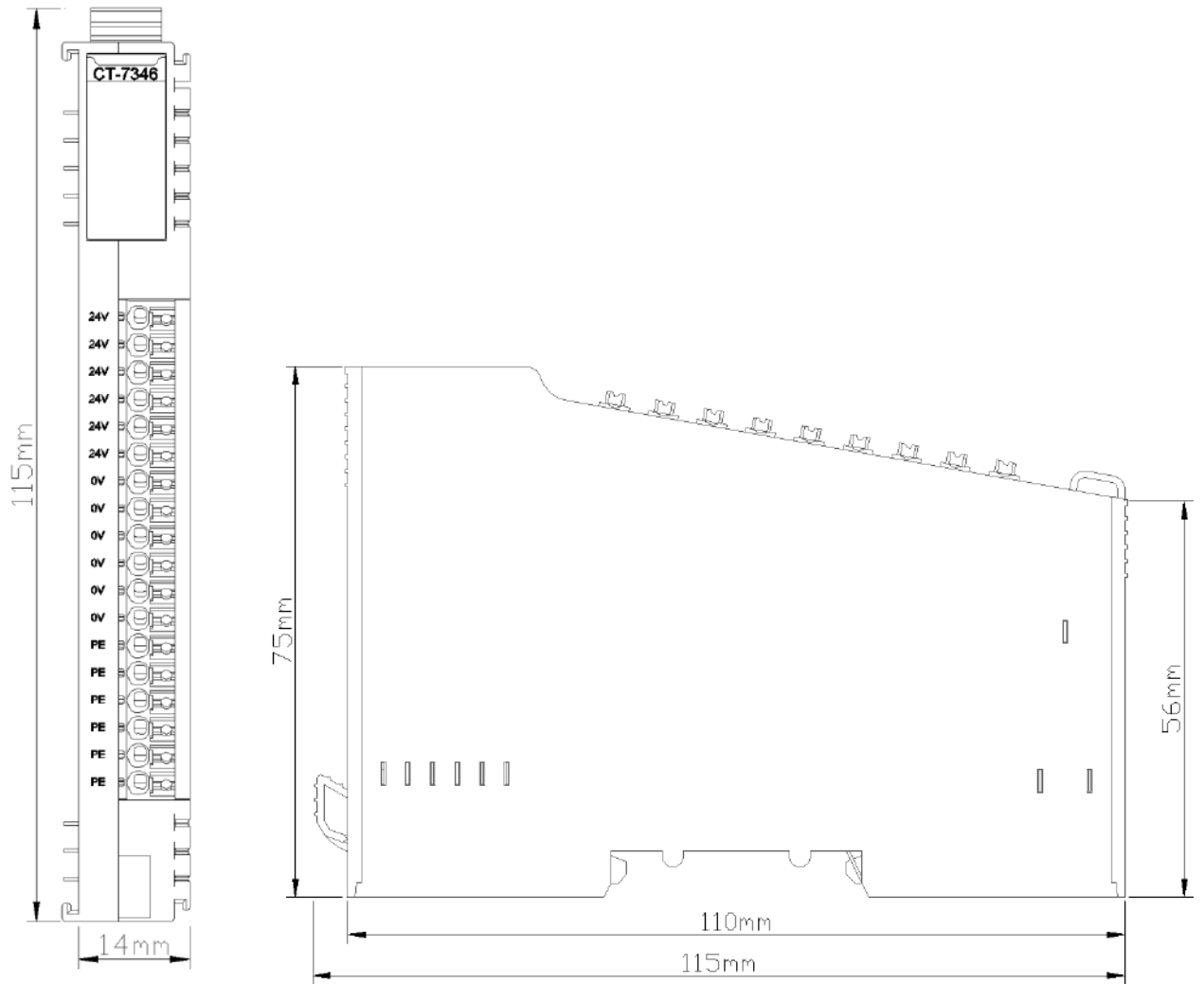

4 IO-Config configuration software

1 Software introduction

IO Config configuration software is use to config Remote IO products, which could realize the module functions of parameter uploading and downloading, process data monitoring, data address table view, device search, firmware upgrade, etc.

Note: when using IO-Config to configure the software, the serial port supports all the protocol adapters for parameter uploading, configuration parameter modification, online monitoring, etc. The Ethernet port only supports the Modbus TCP adapter (CN-8031) for parameter uploading, configuration parameter modification, online monitoring, etc.

The serial MicroUSB cable is required the function of data transmission and power supply. Some mobile USB cable is only with the power supply function, and no data transmission function, so it could not be used for adapter parameters uploading and downloading.

2 Offline configurations

When the device is disconnected to the software, the network adapter and IO module could be preselected according to the user actual module needs, and the software will automatically generate the data address mapping table.

The offline mode is mainly designed for **Modbus adapter**, and the address in the address mapping table is the access address of IO module data. For other protocol adapter, the IO address of the device could be automatically generated after configured in the configuration software of the host station system.

In offline mode, adding module manually to view the address table is as the below steps:

1. Find the installation package, click install IO Config software, and open IO Config configuration software after installation.

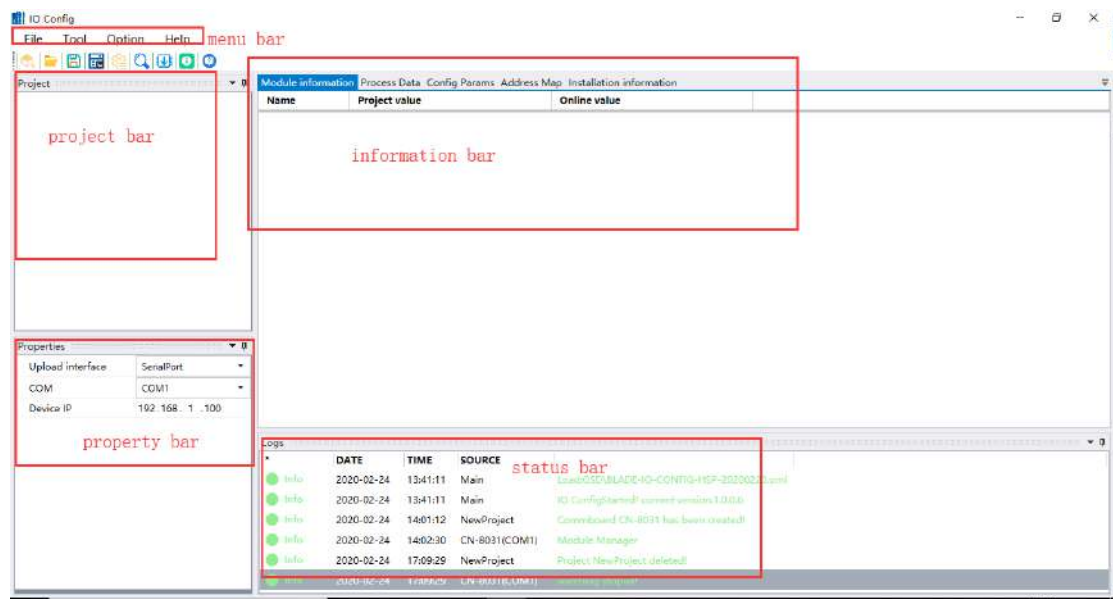

2. Click File→Project→New Project in the menu bar, or click the shortcut key or right-click Project→New Project in the project bar, and fill in the project name.

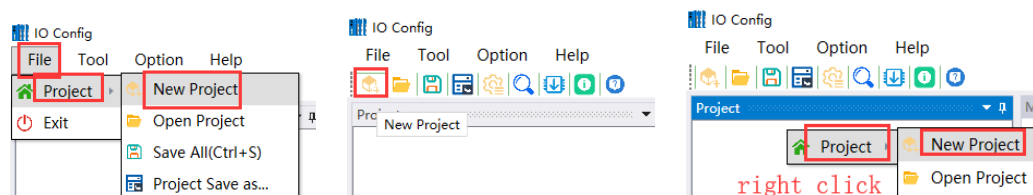

3. Right-click the NewProject Module in the project bar, and select CN-8031 In the

pop-up window, then select one network port or serial port (if selecting serial port and it needs to select serial port number) and click OK.

Note: All network adapter modules could connect to the configuration software for debugging through the serial port. Only MODBUS TCP adapter can connect to the configuration software for debugging both through the Ethernet port and serial port.

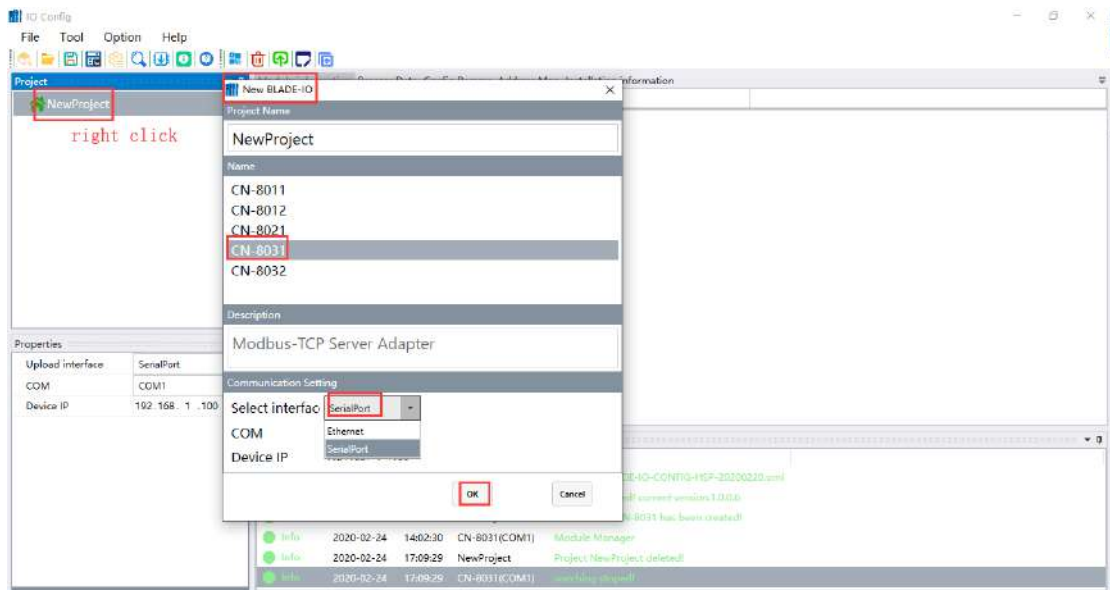

4. Right-click CN-8031→click Module Manager, Double-click to select the detailed IO module that will hang with CN8031 in the pop-up window, and click OK.

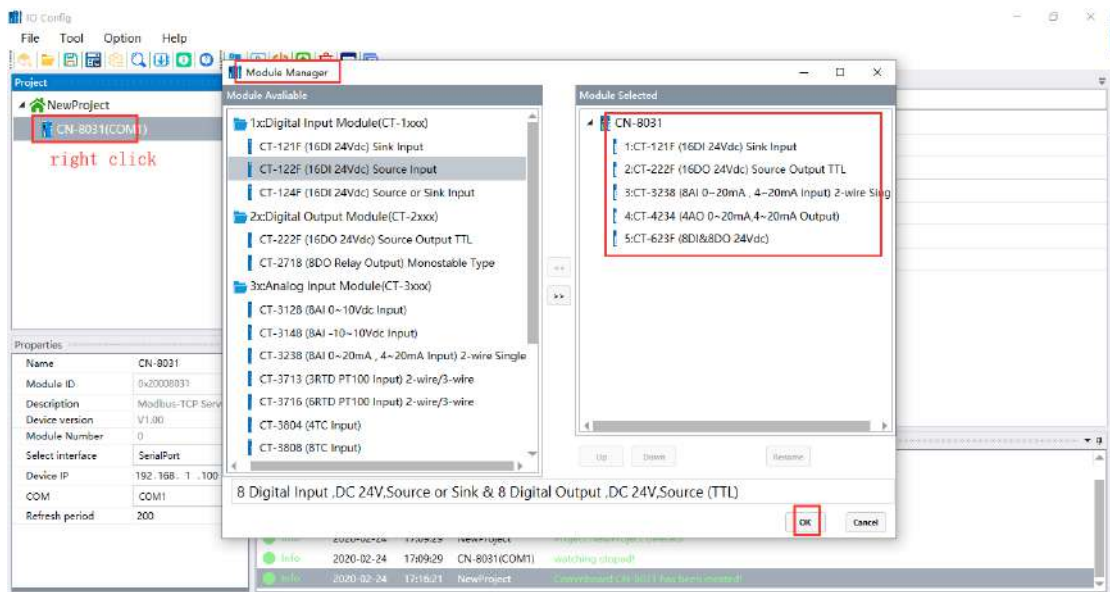

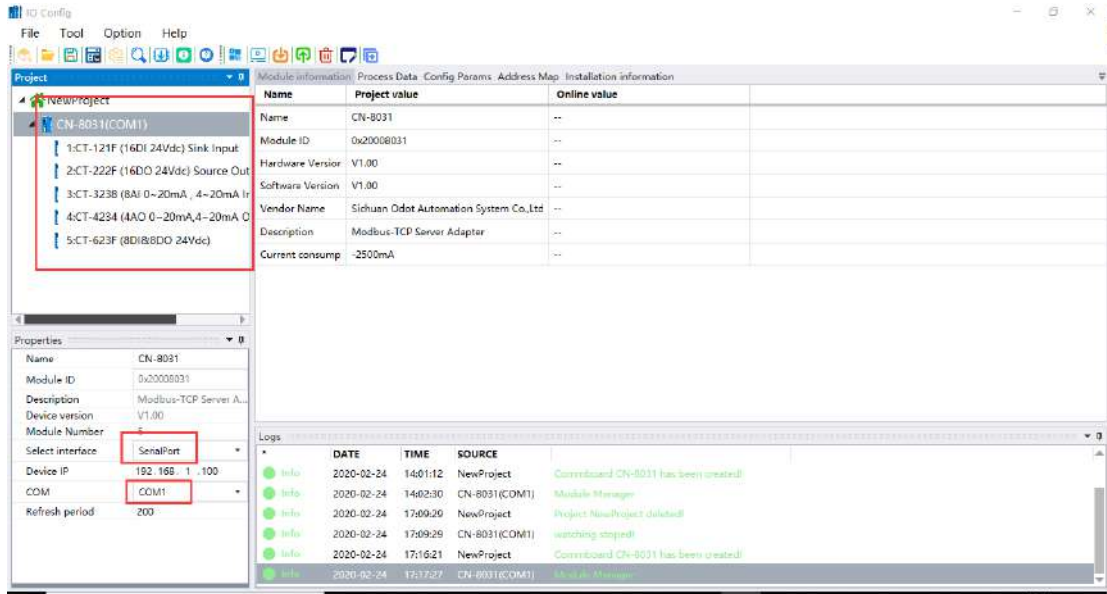

Module manually adding supports shortcut keys "Ctrl C", "Ctrl V" and "Delete" for copy, paste and delete IO module. Select CN-8031 and click the shortcut "Ctrl S" to save the configuration project.

5. Click Basic Information, Process Data, Configuration Parameters, Address Table and Installation Information in the information bar to view IO module information.

In Basic Information interface, you can view the communication protocol and version information of the current adapter module, and the module description and version information of the IO module.

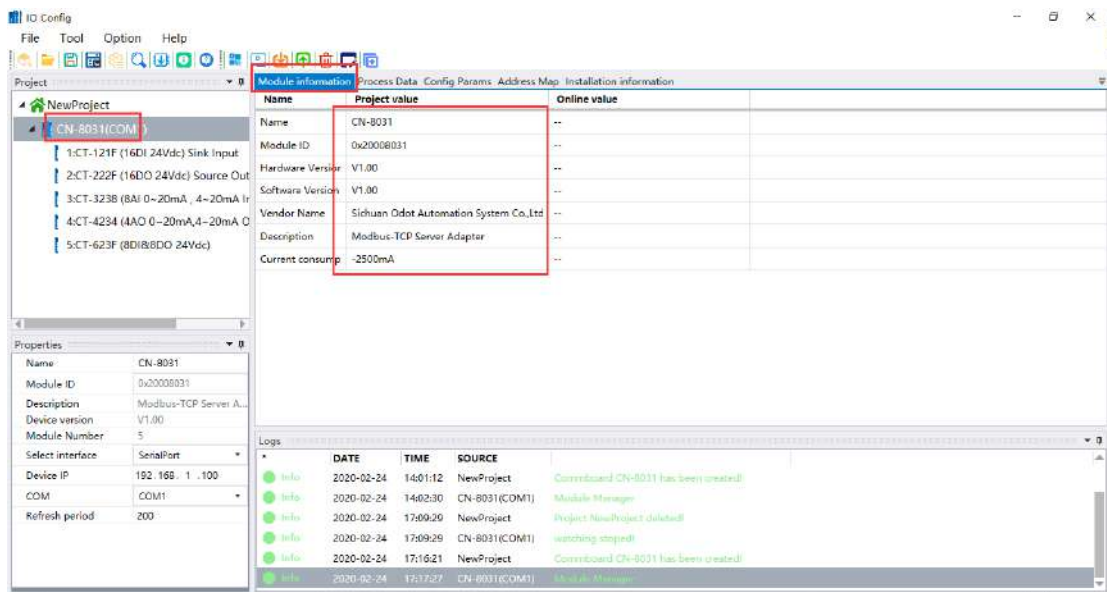

In **Process Data** interface, you can view the data type of the IO module, as well as the online monitoring value of the input data, and the online monitoring value and current value of the output data.

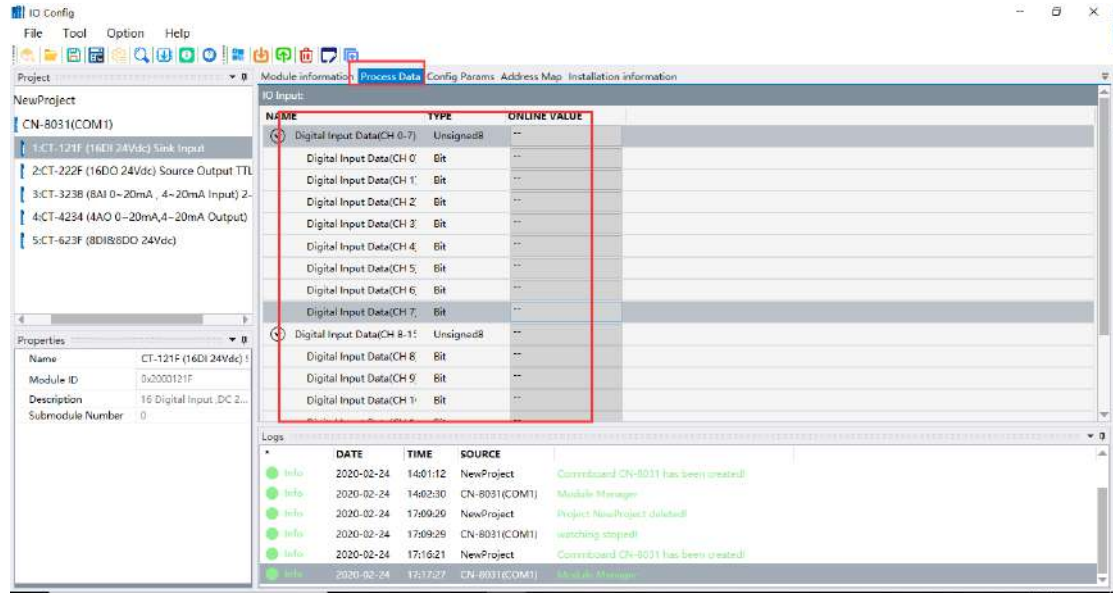

In **Configuration Parameters** interface, the configuration parameters and communication parameters of the adapter module could be set. Configuration parameters of IO module could be set.

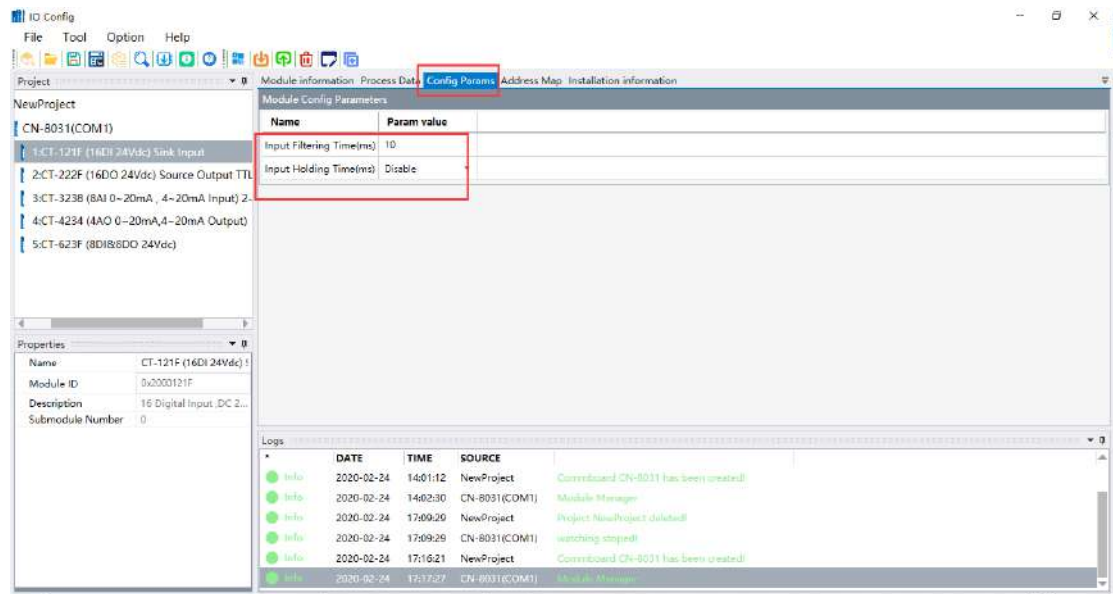

In the **Address Map** interface, you can view the channel address of the IO module. Click the address table save button or the shortcut "Ctrl M" to export the address table.

And address table format is TXT or XLS.

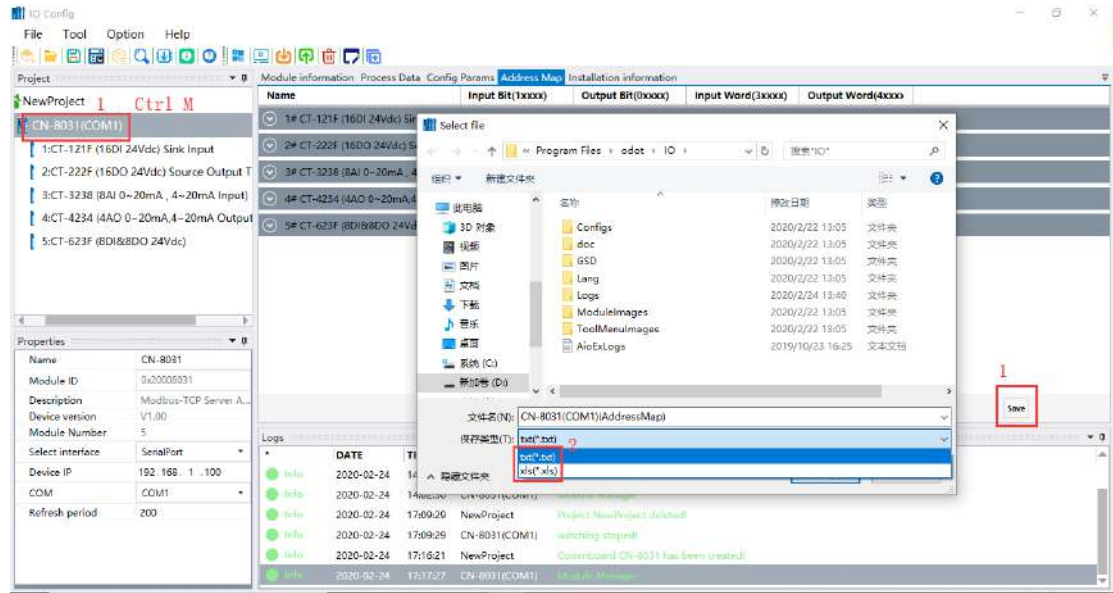
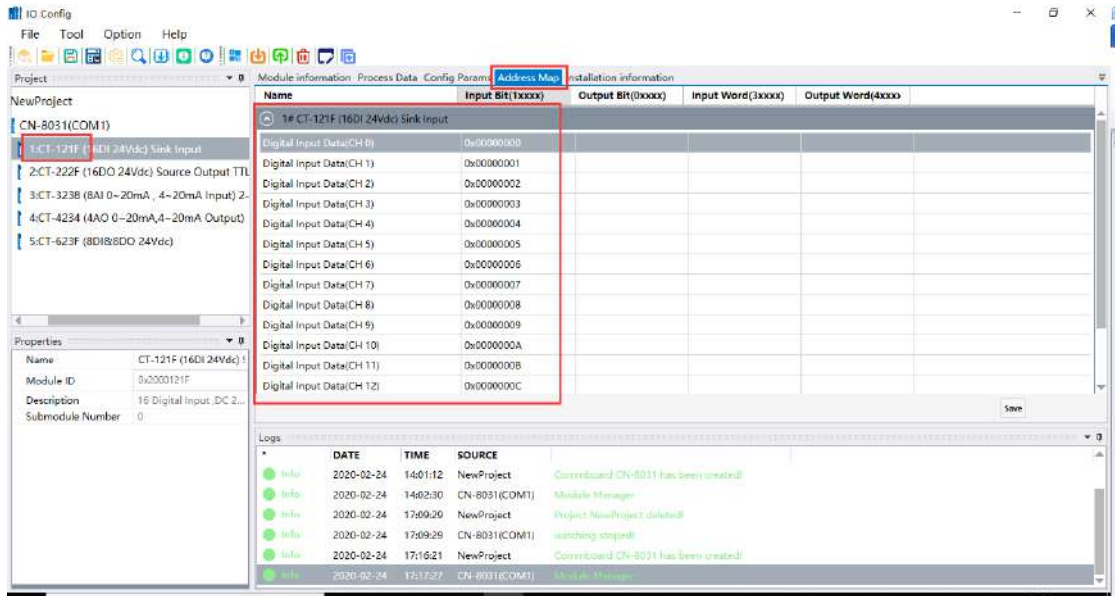

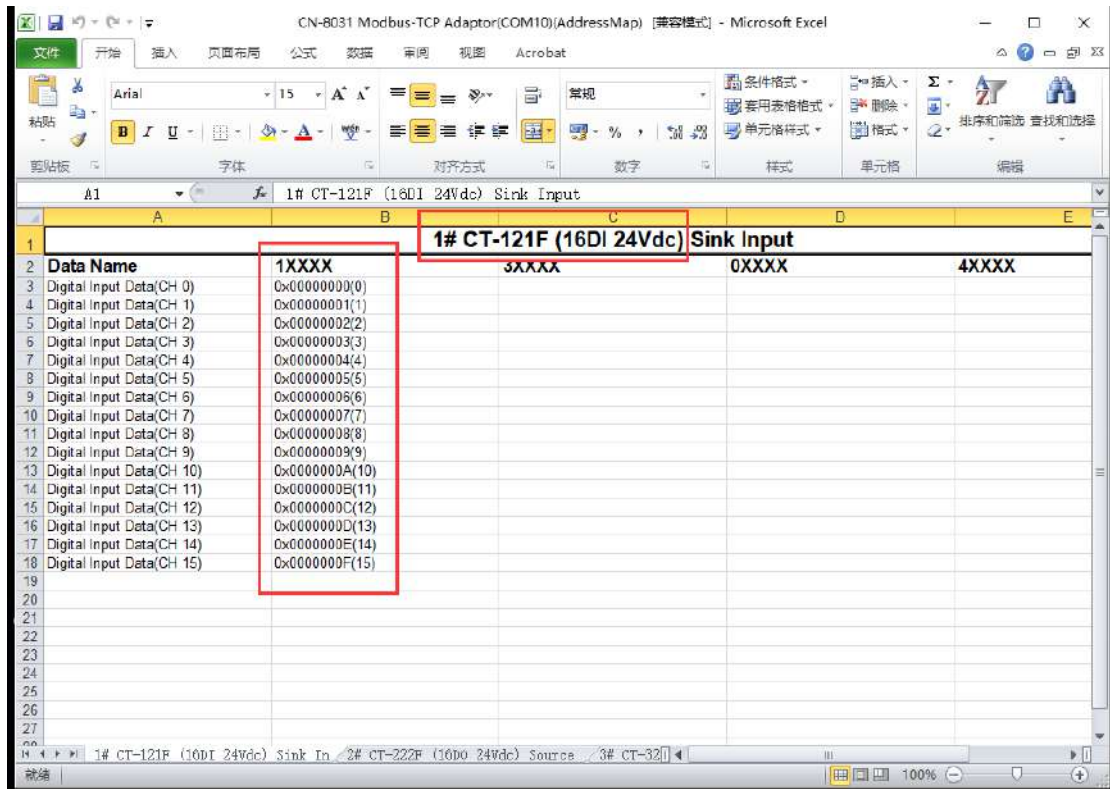
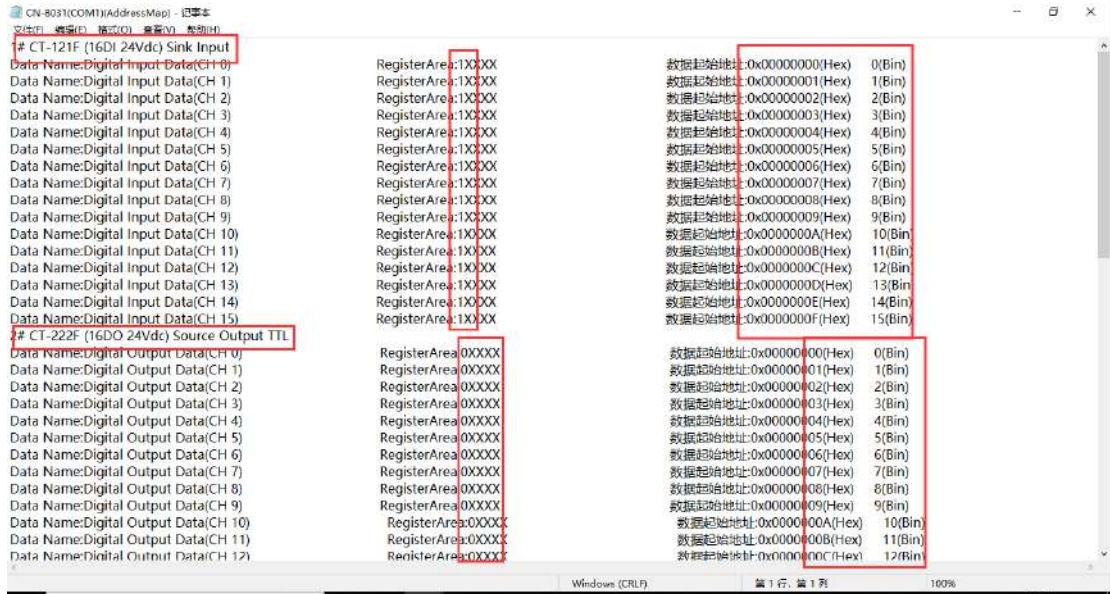

In the Installation Information interface, you can check the current, size and other parameters of the module.

IO Config

File Tool Option Help

Project: NewProject

Module information Process Data Config Params Address Map **Installation information**

CN-8031 (COM1)

- 1:CT-121F (16DI 24Vdc) Sink Input
- 2:CT-222F (16DO 24Vdc) Source Output T
- 3:CT-323B (8AI 0~20mA, 4~20mA Input)
- 4:CT-4234 (4AO 0~20mA, 4~20mA Output)
- 5:CT-623F (6DI&8DO 24Vdc)

Properties

Name: CN-8031

Module ID: 0x20000031

Description: Modbus-TCP Server A...

Device version: V1.00

Module Number: 5

Select interface: SerialPort

Device IP: 192.168.1.100

COM: COM1

Refresh period: 200

CN-8031

Description: Modbus-TCP Server Adapter

Current output: 2500 mA

Module size: LxWxH: 115x52x75 (mm)

Total residual current: 2090 mA

Total size: LxWxH: 115x122x75 (mm)



Logs

	DATE	TIME	SOURCE	
Info	2020-02-24	17:09:29	CN-8031 (COM1)	waiting stopped!
Info	2020-02-24	17:16:21	NewProject	Control board (CN-8031) has been created!
Info	2020-02-24	17:17:27	CN-8031 (COM1)	Module Manager
Info	2020-02-24	17:26:14	CN-8031 (COM1)	Save address map
Info	2020-02-24	17:26:48	CN-8031 (COM1)	Save address map
Info	2020-02-24	17:27:15	CN-8031 (COM1)	Save address map

3 Online configurations

Supplying 24V power to the module, and connect the module to the computer with Micro USB or network cable (Micro USB cable needs to install a driver and the COM port will be automatically assigned after the driver installation, such as COM3).

1. After installing IO Config software, open the configuration software, and click File→Project→New Project in the menu bar , or click shortcut of New Project, or right-click Project→New Project in the project menu bar, and manually fill in the project name.

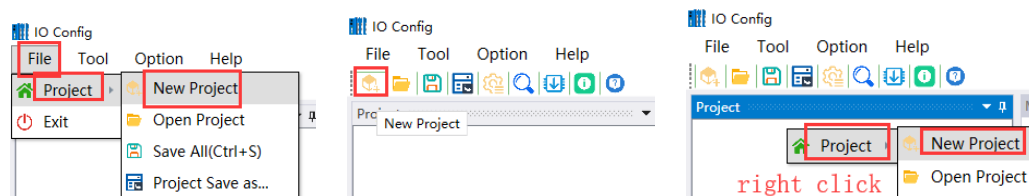

2. In the Property bar, modify the upload interface by selecting serial port and the serial port number is COM10, or modify the upload interface to select Ethernet. The device IP address: 192.168.1.100 (MODBUS TCP communication only). Right-click Project Name→Upload IO Modules, and the IO module will be automatically scanned in the project menu.

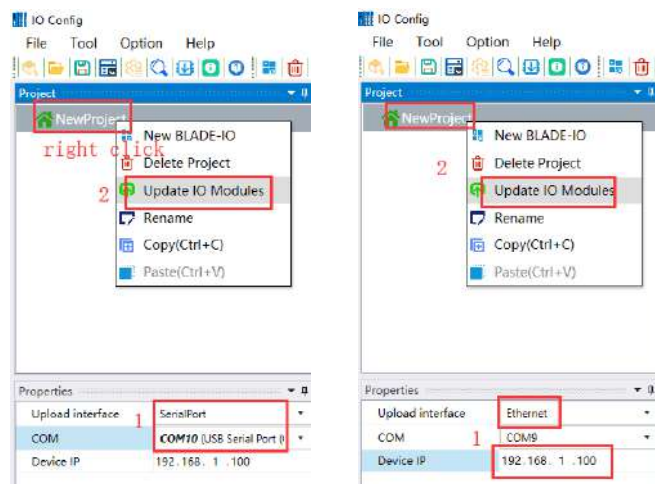

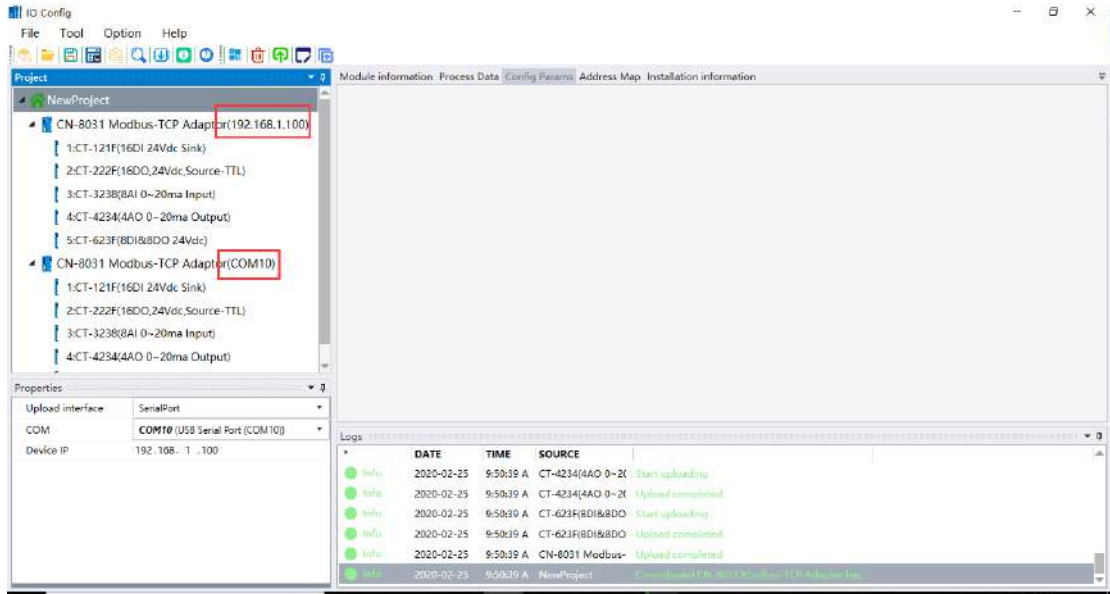

When the adapter module is CN-8031 (MODBUS TCP communication), clicking Tool to search device or click shortcut  to search device, and selecting the Local Network Card in the pop-up interface, then clicking Search Device, and all adapter modules in the network structure will be scanned in the device list. In this interface it could view parameters such as version of adapter hardware and software, IP address and so on. When there are multiple adapters in the network, it supports the function of "Light Up" to find the device, "Download" to modify the adapter IP address and "Restart". When firmwares need to be upgraded, click "Upgrade" to enter the upgrade interface.

Clicking "Upload" and all IO modules will be uploaded automatically in the project menu.

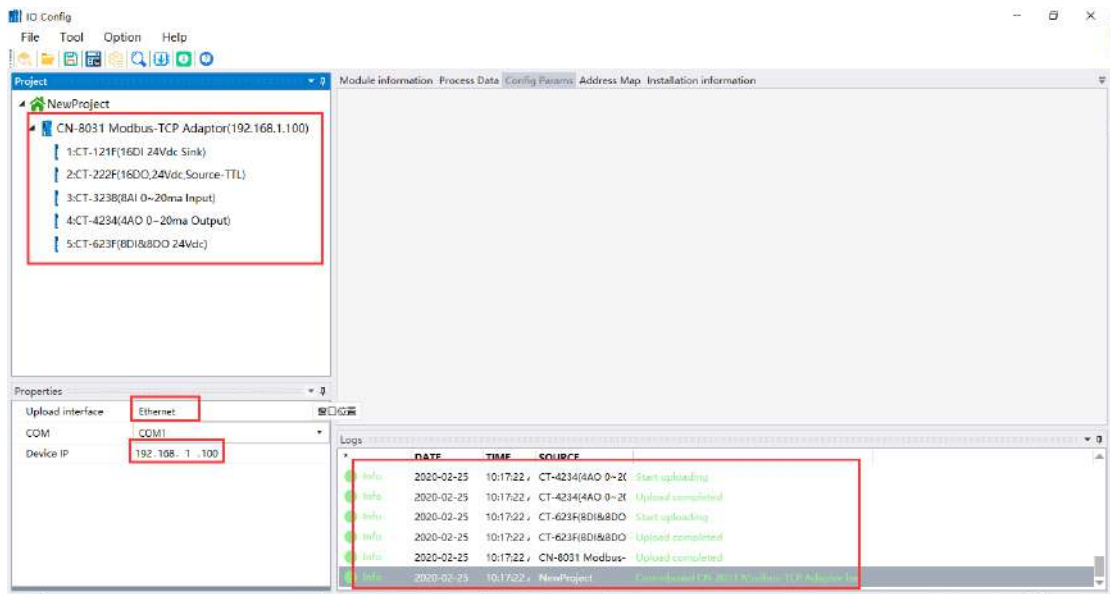
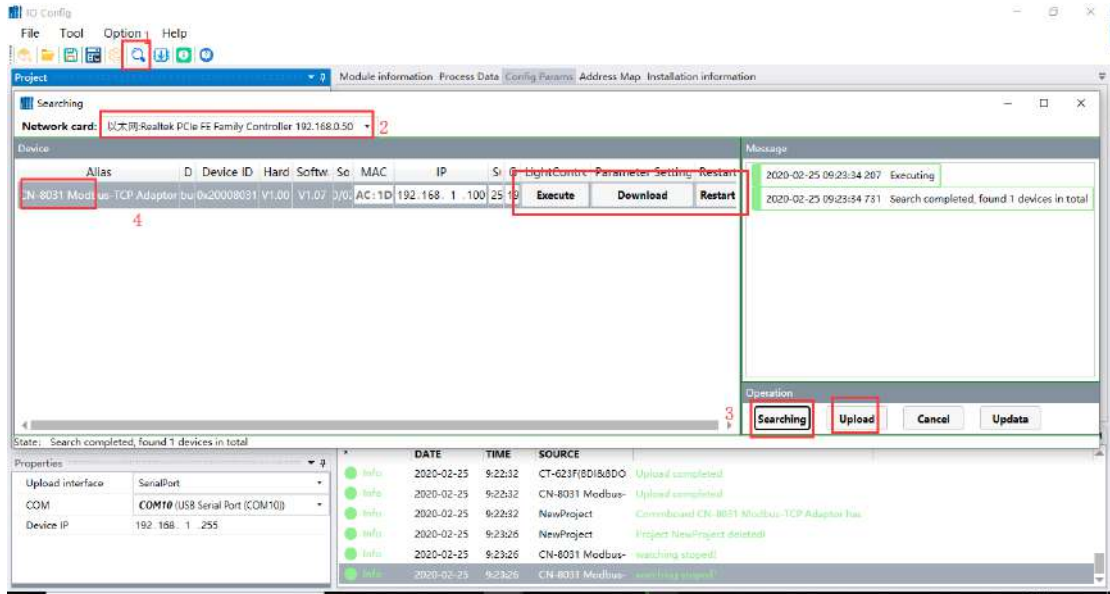

For the digital input module, you can manually add the counting sub-module.

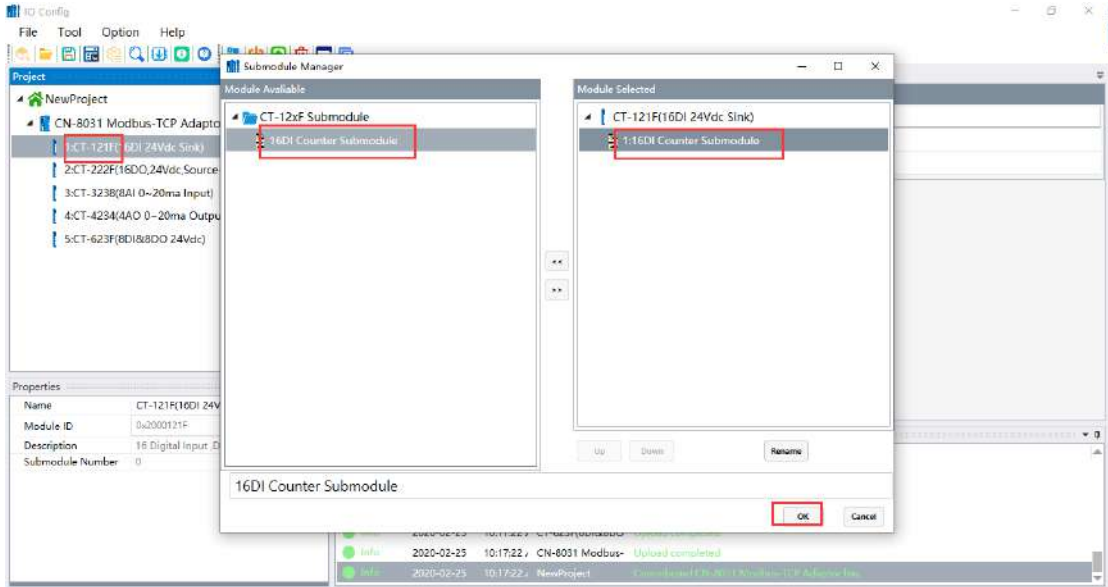

After adding a sub-module, you must right-click to download the module configuration or right-click CN-8031 to download IO parameters. Otherwise, if clicking directly online and it will result in an error in the state menu of "the number of sub-module does not match the total number of configuration sub-module".

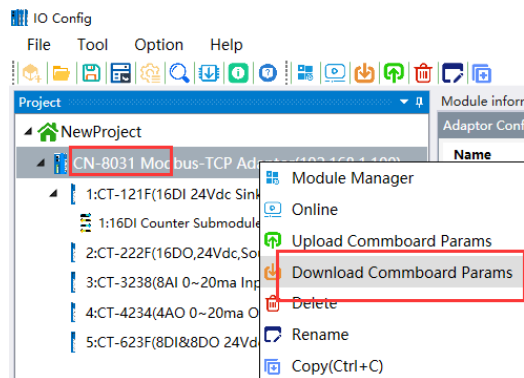
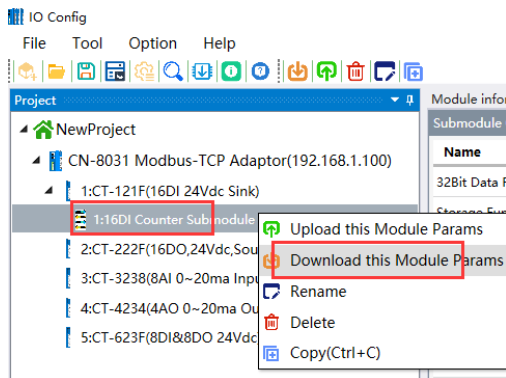

3. Right-click the adapter module CN-8031 and clicking online. It could monitor the IO module data online.

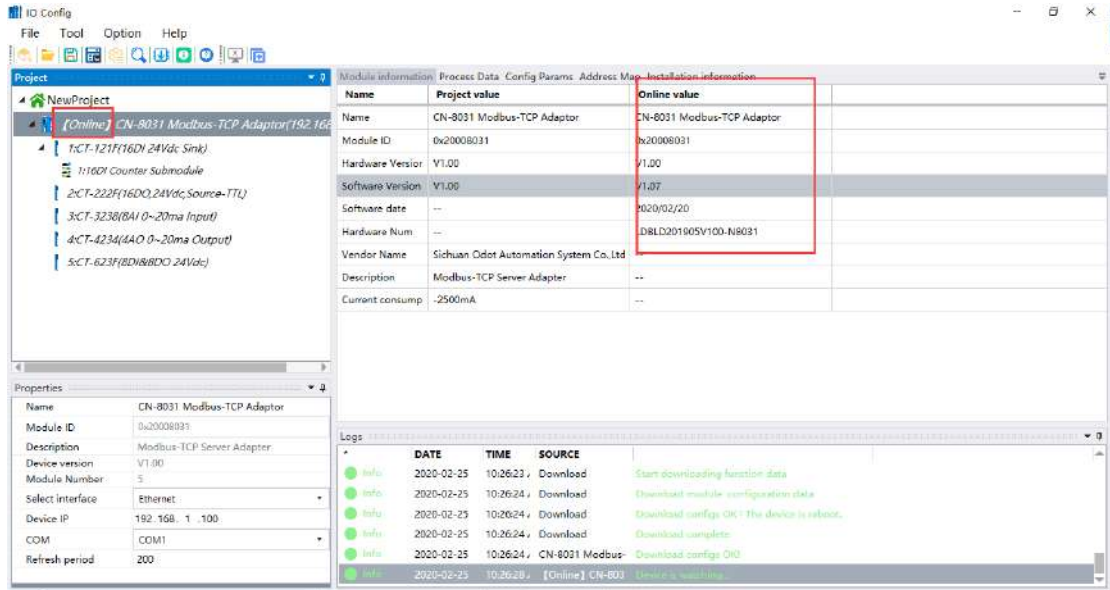

Example: CT-121F in slot 1, the external power 24VDC is supplied to the DI0 of CT-121F. And in the process data interface, the CH0 monitoring value is 1.

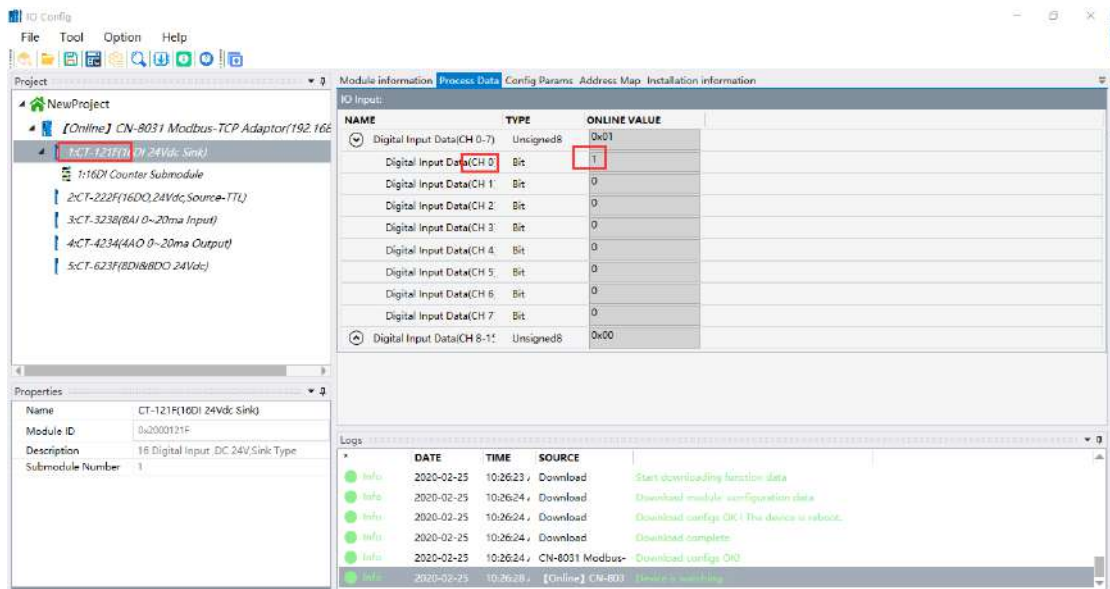

Example: Assigning the CH0 channel of CT-4234 in slot 4 to 16#7530= 30000, and connect it to the CH0 channel of CT-3238 in slot 3 at the same time. The CH0 of CT-3238 monitoring value is 16#3125.

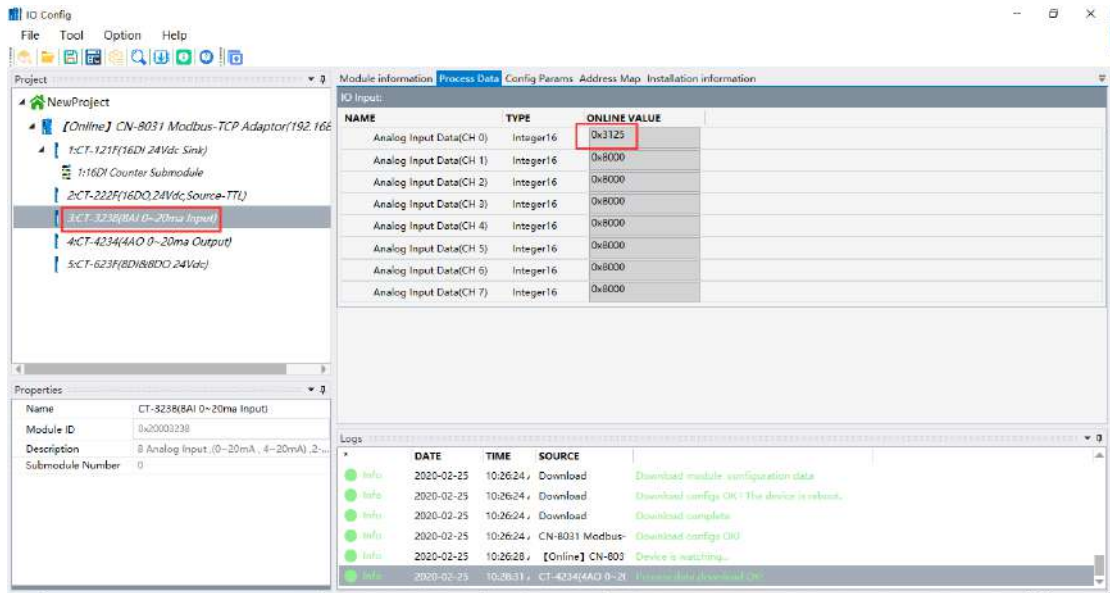
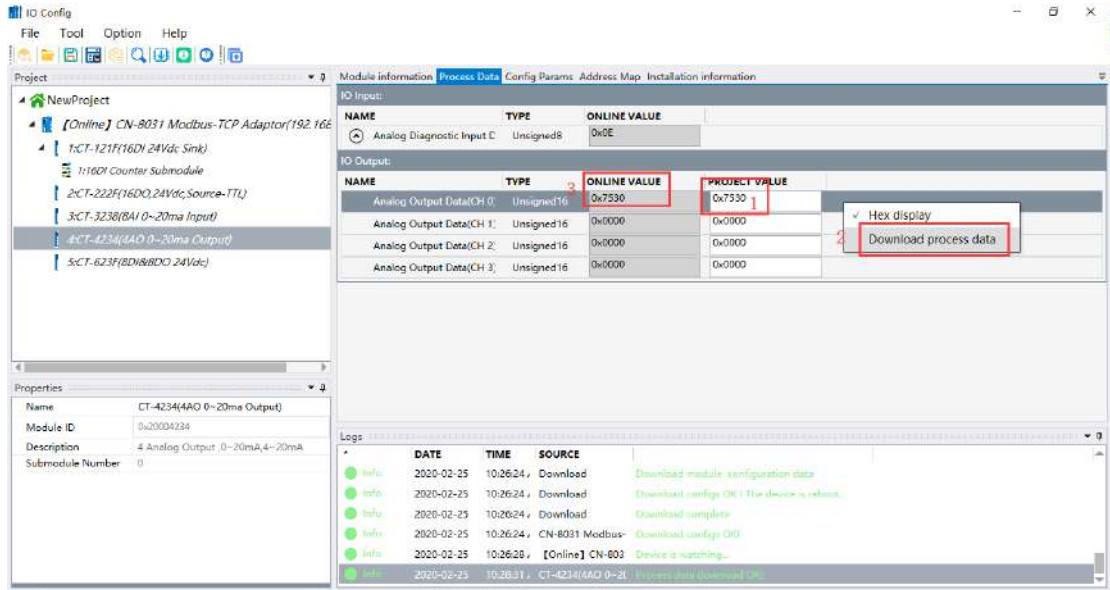

4. Configuration parameters can be modified in the configuration interface.

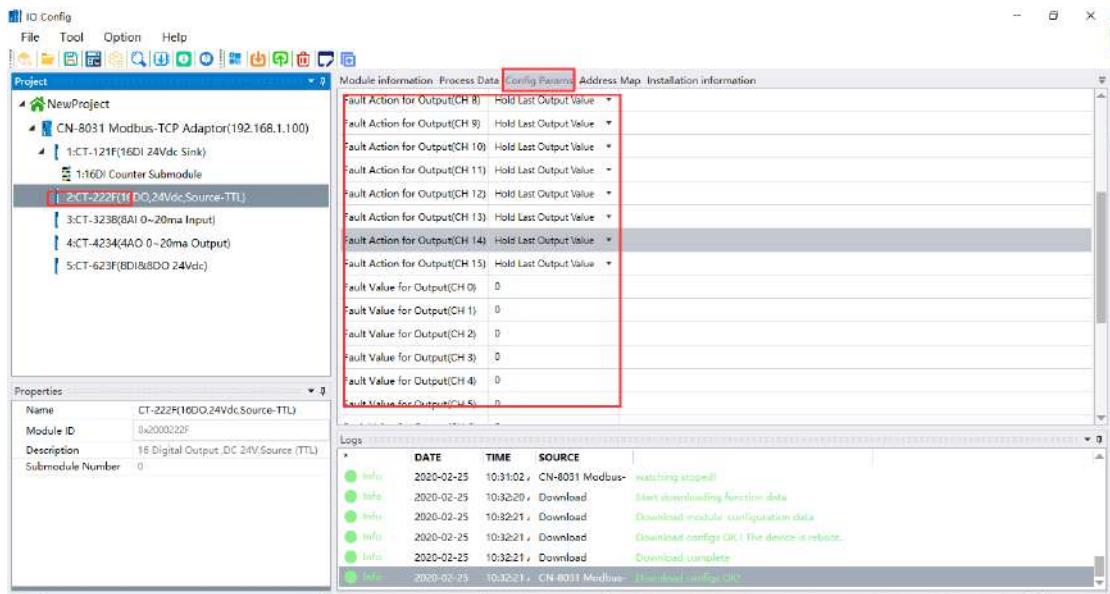
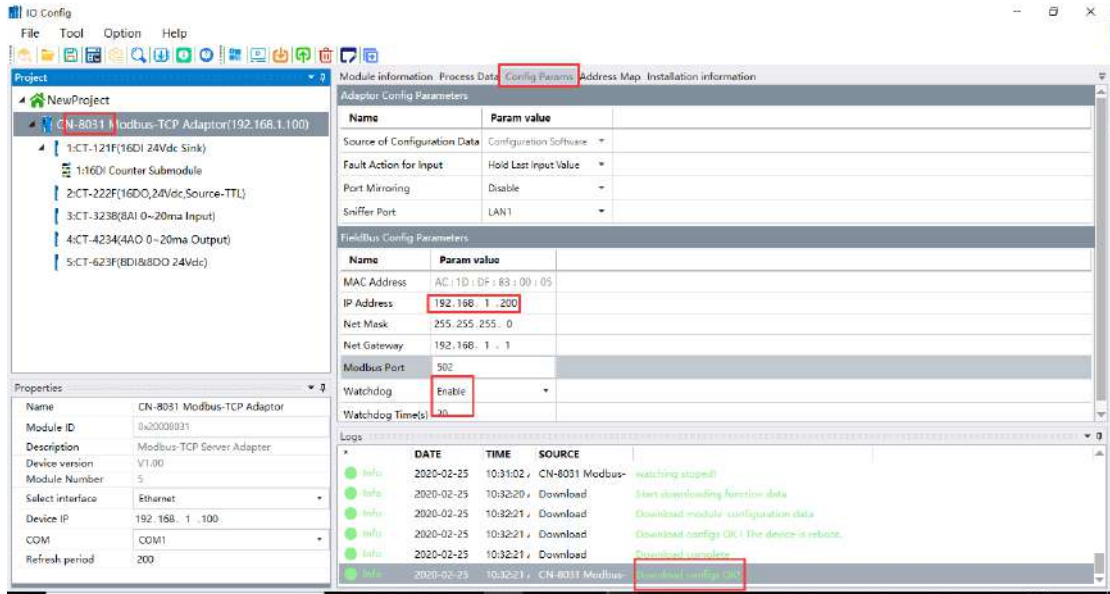

After the parameters are changed, you can right-click on CN-8031-Download IO Parameters in the project bar. So the configuration parameters of the adaptor and IO module could be modified.

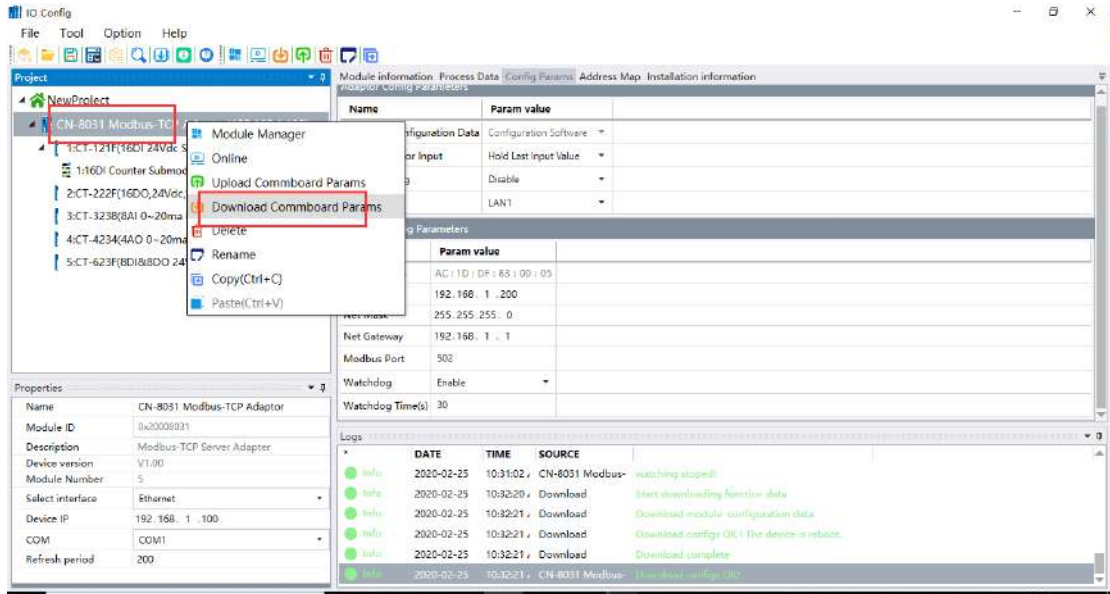

After all parameters are modified, select CN-8031 and click the shortcut key "Ctrl S" to save the configuration project.

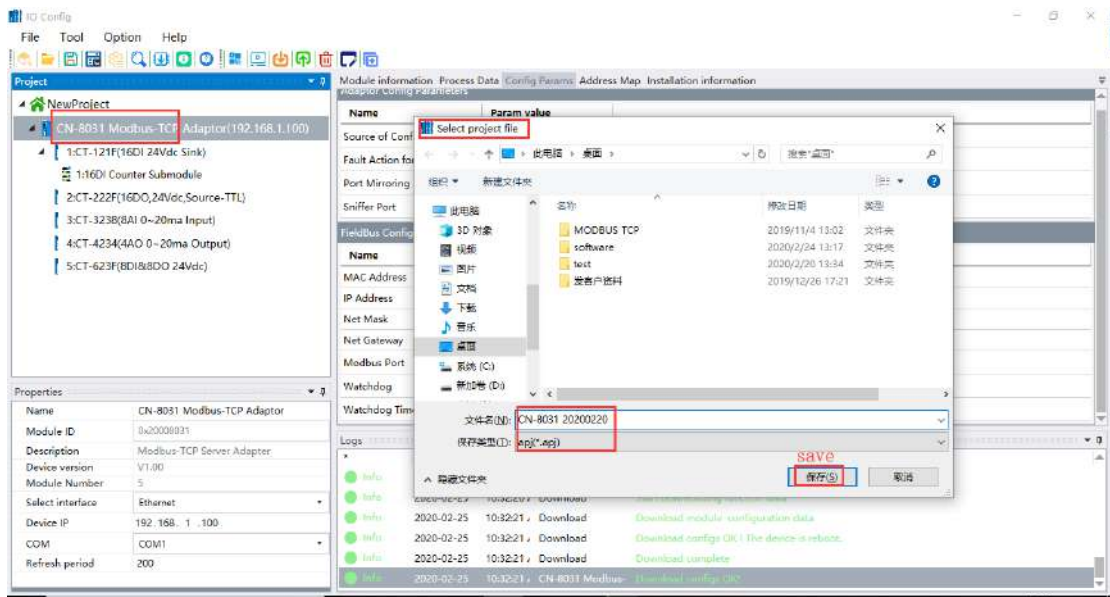

4 Update device library files

Update device library file is used to update the newly added IO module of software. When a new IO module is released, the customer can import the IO module into the configuration software by only updating the device library file, so there is no need to reinstall the configuration software.

First, copy and paste the latest version of the device library file of BLADE-IO-CONFIG-HSP-20200213 into the GSD folder of the software installation directory.



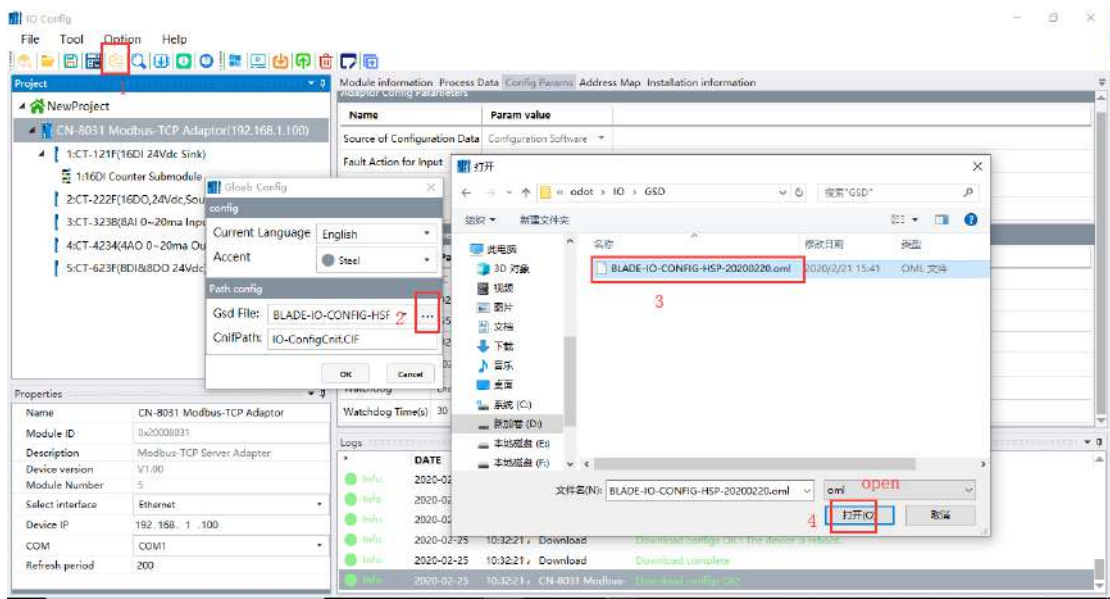

Second, click Option-Configuration or shortcut key  in the menu bar. And in the pop-up window, please find the new library file (.oml) under the 'Path config', and click open to complete the update of the device library File.

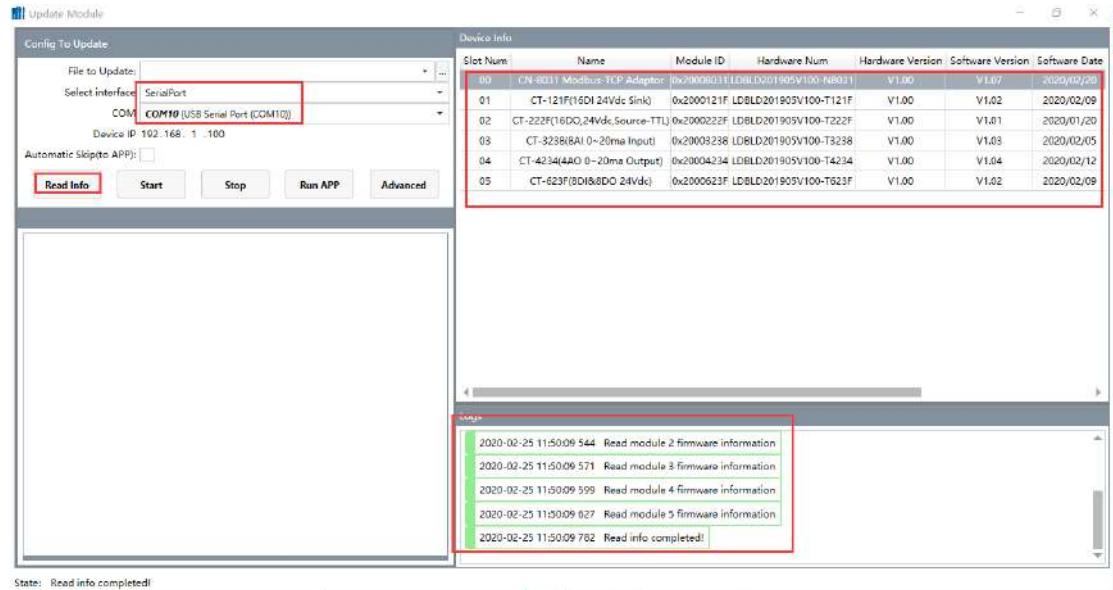

5 Device firmware upgrades

In IO Config software, clicking Tool→Online upgrade or shortcut  and in the pop-up window, selecting "Serial Port" (Ethernet could be selected for MODBUS TCP communication) and the serial port number is "COM10". Click "read Info" to view the version information of the current adapter or IO module.



Click the right side  of the upgrade file, and select the upgrade file (.ofd) of the analog output module CT-4234 in the pop-up window, and open it.

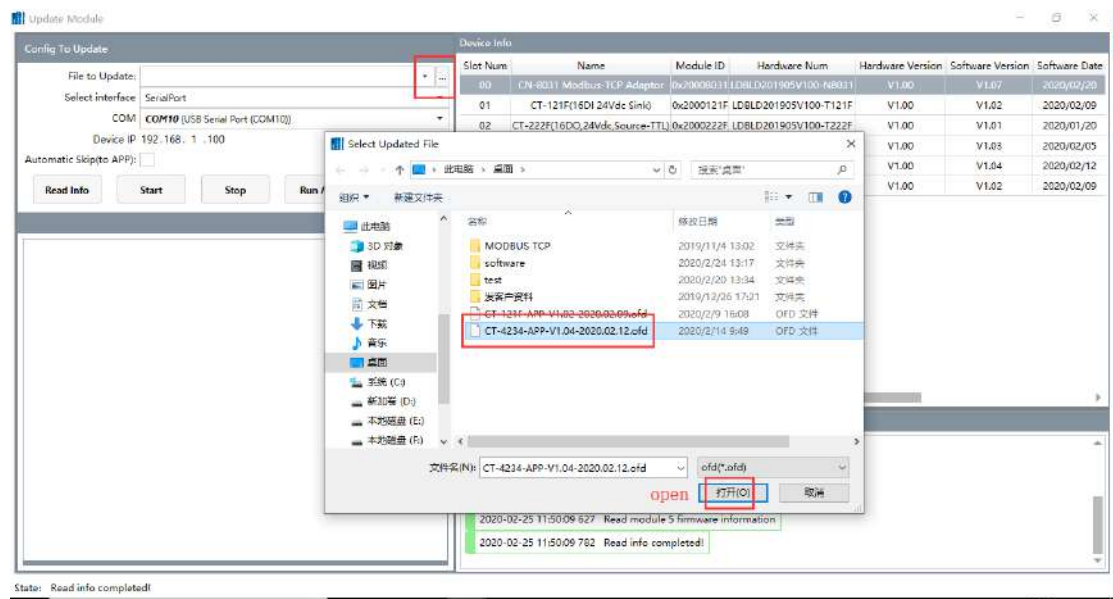

The upgrade version and other information could be viewed in the lower left side of the upgrade menu. And there is no upgrade for the currently firmware version so no need for upgrading. If the version information is inconsistent, please select the slot where the module is located(marking√) and click to start the upgrade.

Note: if the hardware version displayed on the lower left side of the menu is IO module, and it needs to select the slot where the module is located(marking√) and click to start the upgrade.

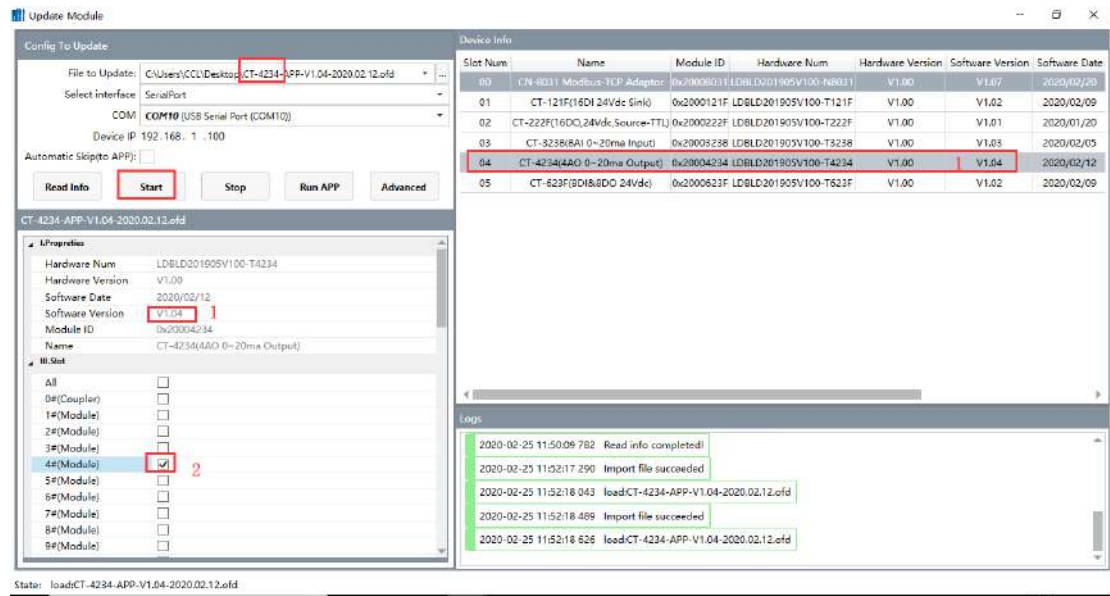

Please note when upgrading: just click to Start for the upgrade, after the upgrade is completed, and it requires to enter APP mode, so it needs to manually click "run APP" or power up the device again.

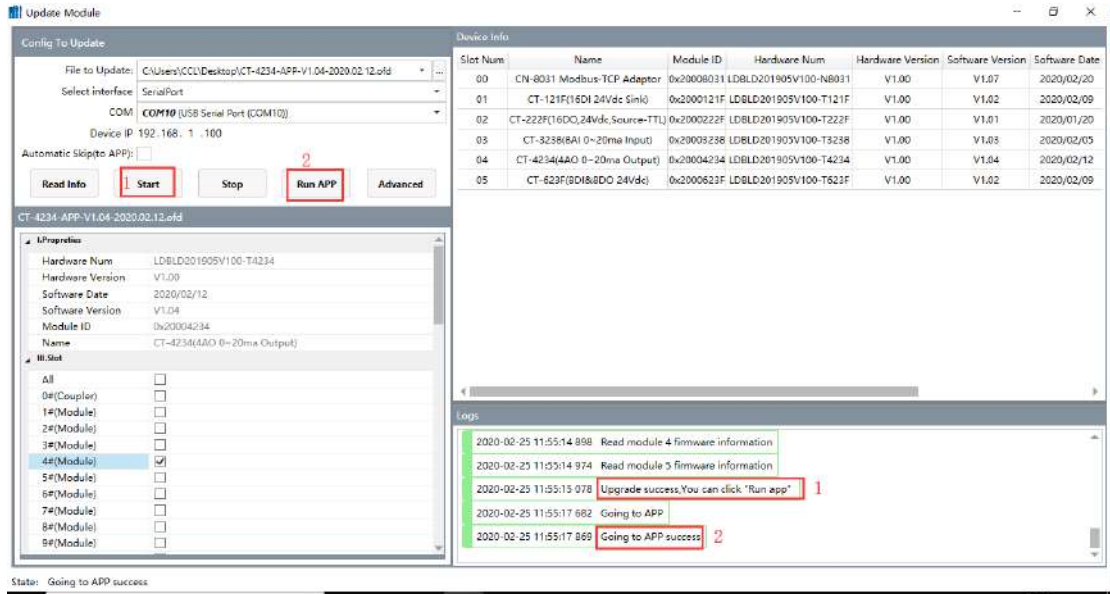

If it only needs to upgrade firmware of one module, you can select Automatic Skip (to APP), and click Start for upgrade, then the APP will run automatically when the upgrade is completed. If it needs to upgrade the firmware of multiple modules, please do not select Automatic Skip (to APP). Clicking Run APP after all the modules upgrade is finished.

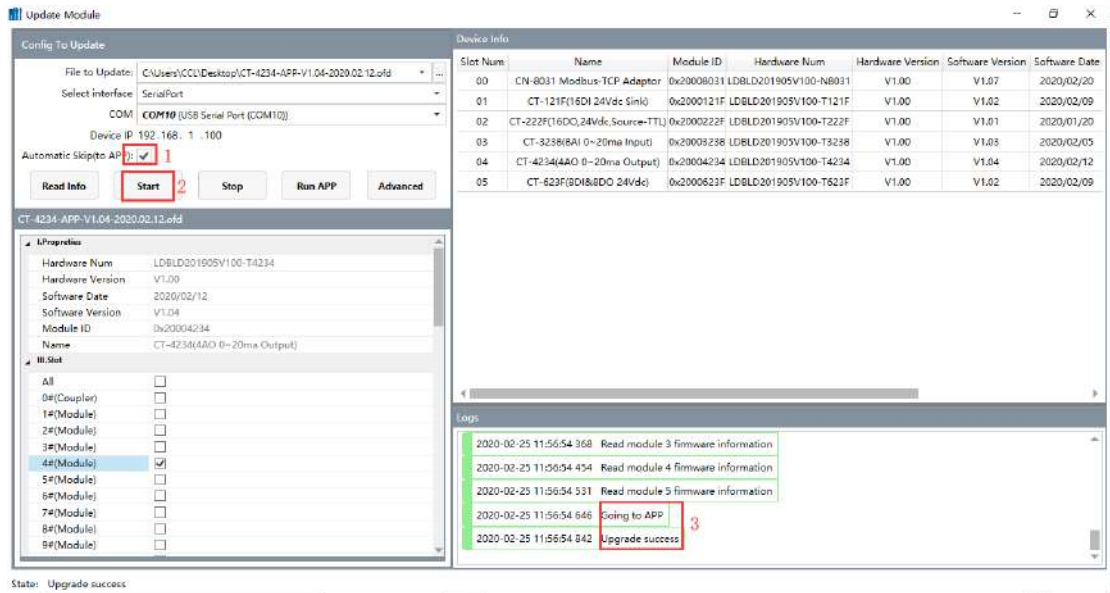

Odot Automation System Co., Ltd.

Add: No.6 Hongsheng Road, Hi-Tech District, Mianyang, Sichuan, China.



Tel: +86-0816-2538289

Zip Code: 621000

Email: sales@odotautomation.com

Web: www.odotautomation.com